

CS*

CHICKEN SWITCH®

**A Portable Actuator for
Remotely Operating
an ITE SBH Breaker**

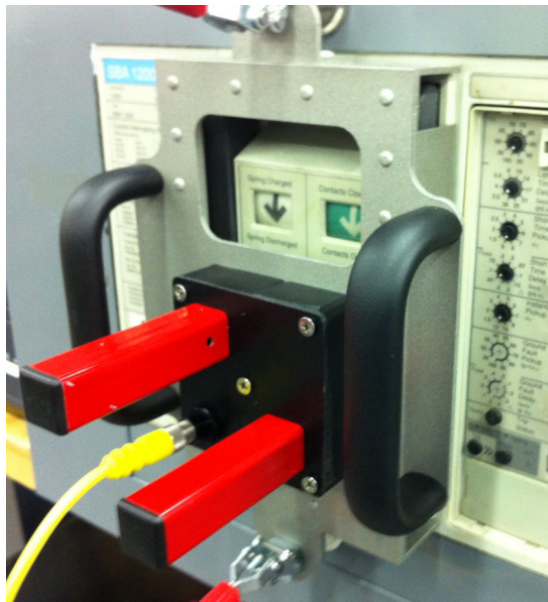

Model SBH-2

User's Manual

CS*

CHICKEN SWITCH®

*User's Manual
for Model SBH-2*

- 1.0 Arc-blast Hazards**
- 2.0 Safety Information**
 - 2.1 Finger pinch points
 - 2.2 Strong magnets
- 3.0 Battery Information**
 - 3.0 Battery Requirements
 - 3.1 Battery Life
 - 3.2 Battery Replacement
 - 3.3 Connecting/Disconnecting Batteries
 - 3.4 Static Discharge Potential
- 4.0 Operation**
 - 4.1 Connecting the control cable
 - 4.2 Sequence of operation
 - 4.3 Attaching and removing the actuator
 - 4.4 Indicator lights
 - 4.5 Hand-Held Controller
- 5.0 Care and Storage**
 - 5.1 Cleaning debris from magnets
 - 5.2 Storage
- 6.0 Warranty**
- 7.0 Specifications**

1.0 Arc-blast Hazards

The hazards associated with electrical arc-blasts are well documented. Studies conducted by numerous industries and professional organizations have sought to quantify the intensity of arc-blast, the risks to personnel, and various methodologies for mitigating the risks.

Without doubt, increasing the distance between the arc and a human is the single greatest favorable factor in reducing injuries.

The Chicken Switch® is not a panacea but rather one more tool available for protecting workers while they are performing electrical switching.

Using a Chicken Switch® may not negate the need for additional personal protective measures. The user is ultimately responsible for evaluating each situation to determine if additional protective measures are needed.



WARNING

Electrical switching may present risk of serious injury or death. This device should only be used by qualified persons after careful analysis of the hazards.

2.0 Safety Information

ALWAYS connect the control cable to the actuator BEFORE installing the Chicken Switch®.

2.1 Finger pinch points

NEVER place your fingers in the area where the actuator extends when the control station is connected to the actuator. The actuator could pinch your hand/fingers against something nearby.



Also, keep fingers clear of the bottom of the actuator near the magnets when the actuator is near a ferrous surface.

2.2 Strong magnets

The holding magnets are very strong. Keep magnetically-sensitive objects such as watches or computer disks away from the bottom of the actuator.

3.0 Battery Requirements

- Eight (8) AA alkaline cells are required. Carefully observe polarity when installing cells.
- Only Alkaline batteries should be used.

3.1 Battery Life

- A set of fresh alkaline cells should give hundreds of operations.

3.2 Battery Replacement

- ALWAYS disconnect the control cable before replacing batteries to avoid possible static damage of the electronics!

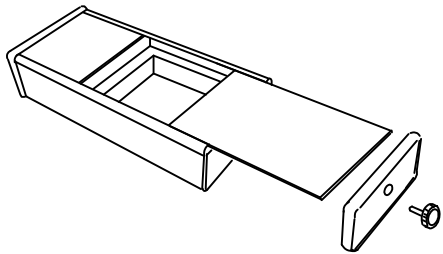

- Turn the control station upside down, remove the endplate retaining knob. Remove the endplate and slide the cover out as shown below.

3.3 To connect/disconnect batteries:

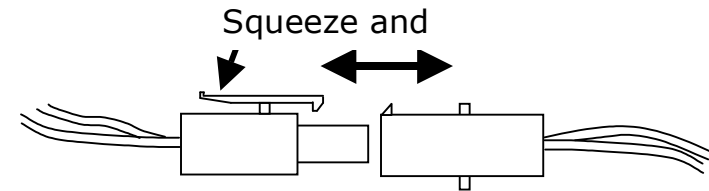

3.4 CAUTION: Static Discharge Potential

- To avoid possible damage to electronic components disconnect the control cable before replacing batteries.

WARNING

To avoid possible damage to electronic components disconnect control cable before replacing batteries.

4.0 Operation

ALWAYS connect the control cable to the actuator BEFORE installing the Chicken Switch®.

4.1 Connecting the control cable:

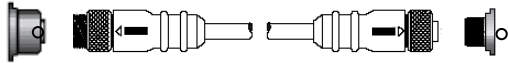

1. Align the arrow on the cable end with the top of the receptacle.
2. Push in and engage the threads on the coupling nut and turn clockwise.
3. After one or two turns of the coupling nut, push in on the cable end. Repeat this until the connector is fully seated.
4. Use a similar technique of turn-stop-and-pull to disengage the cable ends.

4.2 Sequence of Operation:

1. Connect the control cable to the actuator.
2. Plug the control cable into the control station.
3. Follow steps on next three pages to attach the actuator
4. Ensure you are at a safe distance from the circuit breaker that is to be operated.
5. Turn the Power Switch on top the controller to the ON position. The amber LED should illuminate indicating the unit is ready.
6. When ready to operate actuator, press and hold the ENABLE button while depressing either the OPEN or CLOSE button for the desired operation.

Both buttons must be held depressed until the actuator has fully depressed the buttons.

7. Release the ENABLE and OPEN and CLOSE buttons and the actuator will retract.

4.3 Attaching and Removing the Actuator:

Step 1

Make sure that both actuators are fully retracted by assuring the plungers are not protruding more than 1/8".

CAUTION
If plungers are protruding, the breaker could inadvertently be OPENED or CLOSED when the actuator is installed over the breaker.

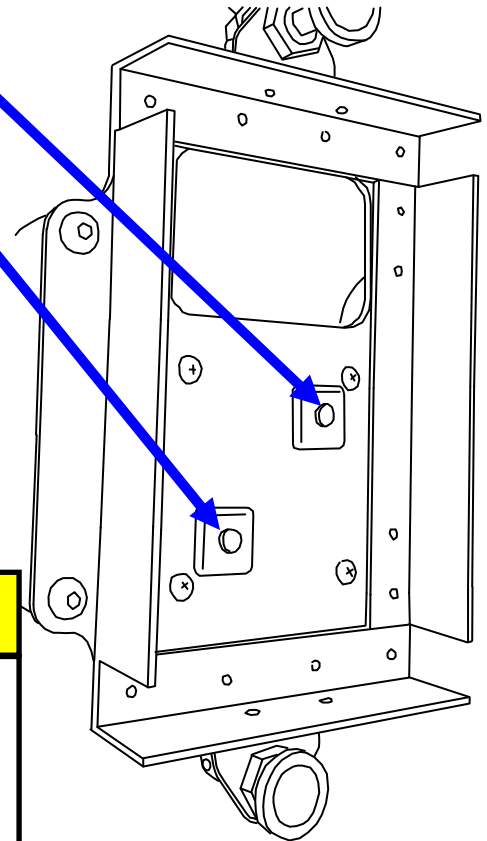

Step 2

Make sure both magnet levers are in the retracted position

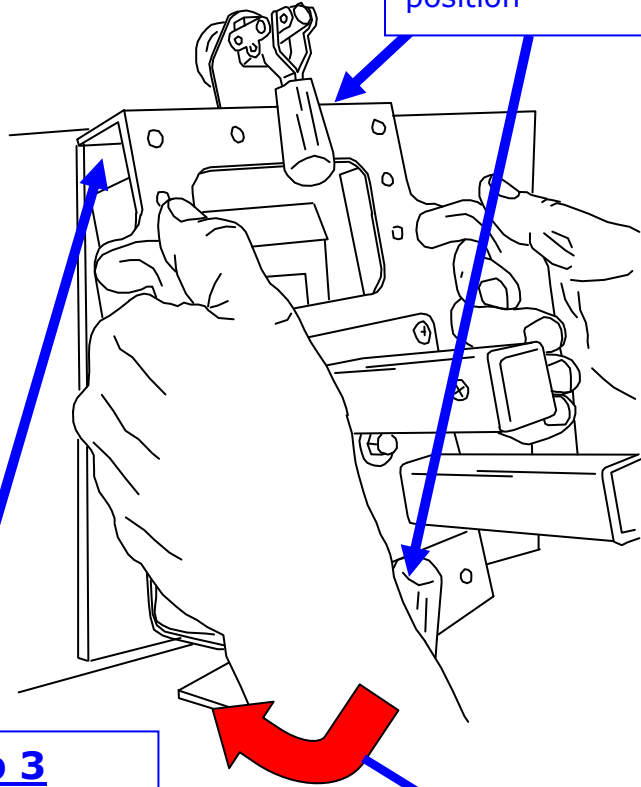

Step 3

Align actuator at top of breaker

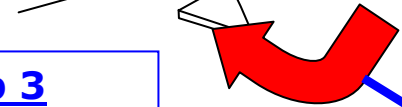

Step 4

Tilt actuator into place over the breaker



Step 5

While holding actuator firmly in place, rotate magnet levers to lock magnets in place.

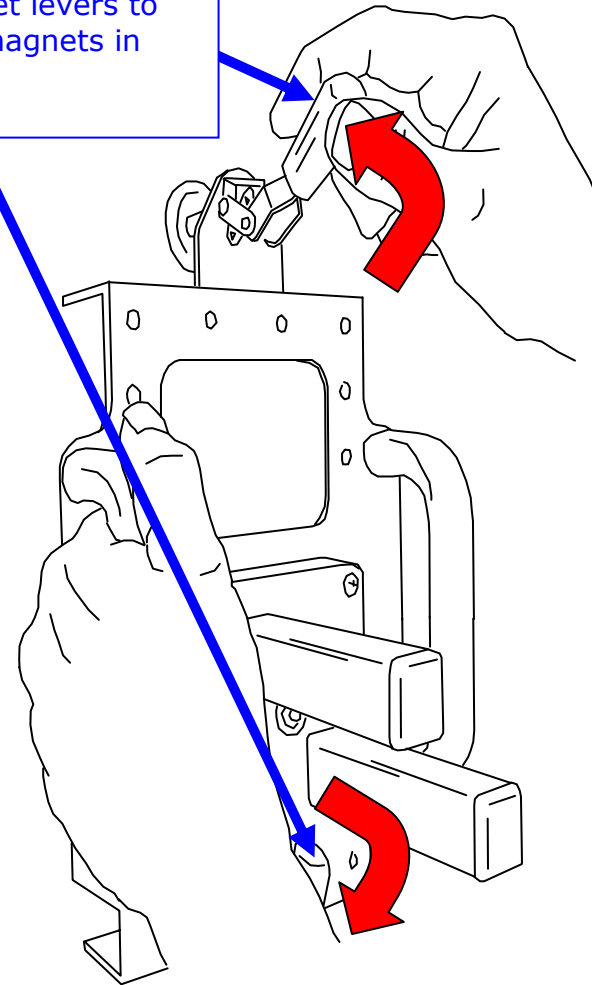

Step 6

Actuator should now be firmly held in place with both magnets engaging the panel door.

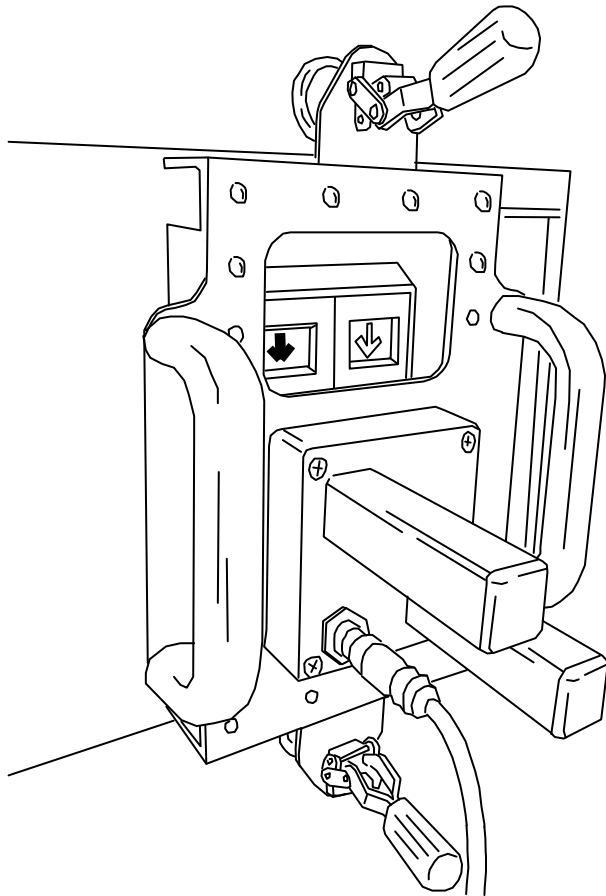

Reverse the above steps to remove the actuator.

4.4 The indicator lights & controls:

NOTE: Red and Green indicator lights only work when the ENABLE button is depressed.

GREEN: indicates the actuator is being commanded to extend the ON actuator.

RED: indicates the actuator is being commanded to extend the OFF actuator.

YELLOW: indicates the hand-held controller is powered and is ready.

Rapidly blinking YELLOW indicates the battery voltage with zero load has fallen to an unacceptable level. Operation is inhibited until batteries with an acceptable voltage level are installed.

The ENABLE button:

The Enable button must be continuously depressed in order to command the actuator.

Releasing the enable button has the same affect as releasing either the ON or OFF buttons – both actuators will move to the retracted position.

Note:

If either of the actuators are held in the extended position for longer than approximately 2 seconds the actuator will de-energize and will remain in extended position. When the pushbutton or the enable button is released, the actuator will retract.

4.5 Hand-Held Controller

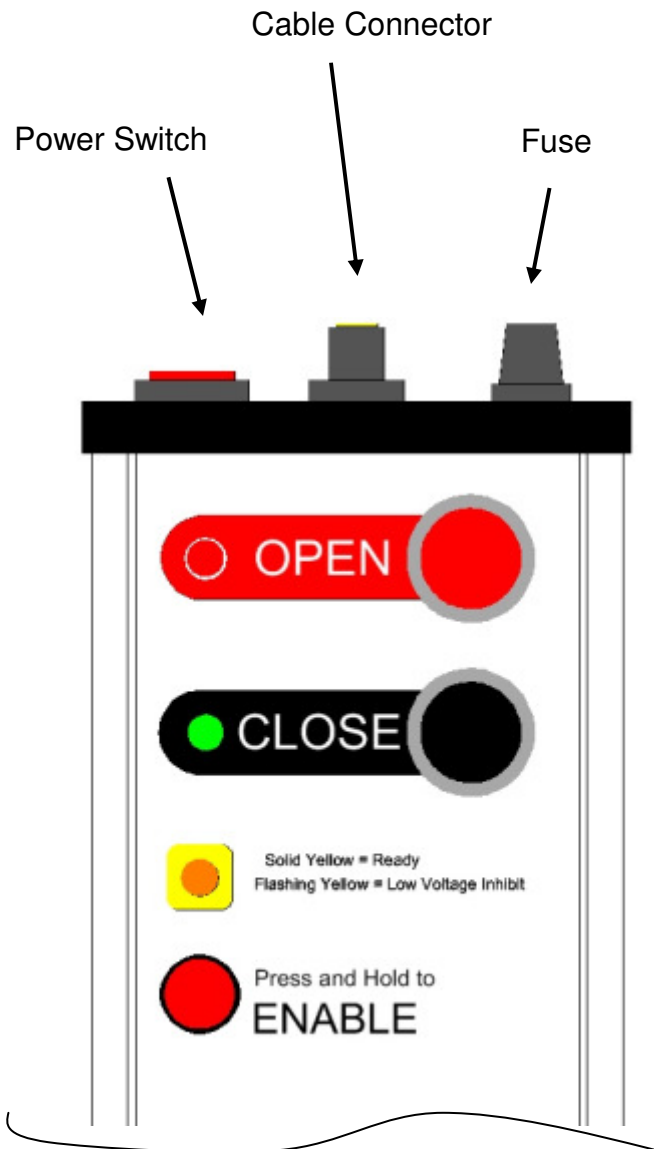

5.0 Care and Storage

5.1 Cleaning the magnets

Over a period of time, the magnets may attract ferrous debris. Exercise care to avoid setting the actuator where the magnets might attract debris. If this does occur, use a paper towel or nylon bristle brush to clean the face of the magnets. Keeping the magnet faces clean ensures that maximum holding power is maintained.

5.2 Storage

Remove all batteries from the control station if the device will not be used for longer than 6 months.

Never store the batteries where the ambient temperature might exceed 110° F.

Avoid getting the unit wet or storing it in a high humidity location.

6.0 Warranty

MarTek Ltd. guarantees all products manufactured by MarTek Ltd. only against defects in materials and/or workmanship for a period of twelve (12) months commencing on the date the product is received by the customer. THIS WARRANTY IS IN LIEU OF ALL OTHER EXPRESS OR IMPLIED WARRANTIES INCLUDING THOSE OF MERCHANTABILITY AND FITNESS FOR A PARTICULAR PURPOSE.

MarTek Ltd. will, at its option and its cost (including shipping expenses for return and re-delivery), repair, replace or refund the purchase price of any product manufactured by MarTek Ltd. which has a defect in materials and/or workmanship. THIS IS CUSTOMER'S EXCLUSIVE REMEDY FOR BREACH OF WARRANTY. IN NO EVENT WILL MARTEK LTD'S LIABILITY FOR DAMAGES (WHETHER ARISING FROM BREACH OF CONTRACT OR WARRANTY, NEGLIGENCE, STRICT LIABILITY OR OTHERWISE) EXCEED THE PURCHASE PRICE OF THE PRODUCT CONCERNED NOR WILL MARTEK LTD. BE LIABLE FOR PUNITIVE, INCIDENTAL, CONSEQUENTIAL OR SPECIAL DAMAGES (INCLUDING WITHOUT LIMITATION LOST PROFITS) EVEN IF ADVISED OF THE POSSIBILITY OF SUCH DAMAGES.

MarTek Ltd. reserves the right to disallow warranty repairs if the unit has been disassembled or misused, as determined by MarTek Ltd. in good faith. Please contact us at (800)-248-4958 for a return authorization.

MarTek Ltd.

4806 Chimney Drive
Charleston, WV 25302
1-304-965-9220
1-800-248-4958

7.0

Specifications

MECHANICAL

Holding magnets:	Two magnets, each rated @ 55.1 lbs force, 12,600 Gauss.
Projected life:	20,000 operations

ELECTRICAL

Operating voltage:	12 volts DC
Fuse:	3 amp
Power supply:	8 AA alkaline disposable batteries. When used properly, one set of batteries should yield hundreds of operations.
Control Cable:	30 feet in length (9.1 meters), 5-conductor, extra-flexible, PUR insulation
Controller:	Requires two-hand operation. The 'enable' button must be depressed while depressing the ON or OFF buttons. A programmable micro-controller manages control inputs, linear actuators, and performs timing functions to protect the actuator in a stalled condition. Intelligent 'H-bridge' motor drivers provide start/stop/braking actuator functions.

MarTek Ltd.

**4806 Chimney Drive
Charleston, WV 25302**

1-800-248-4958

www.chickenswitch.com

Chicken Switch is a Registered Trademark of MarTek Ltd.

US Patent 7,623,011

Copyright 2004-2012, MarTek Ltd. All rights reserved.