

clarion

*Owner's manual / Mode d'emploi
Bedienungsanleitung / Istruzioni per l'uso
Gebruiksaanwijzing / Manual de instrucciones
Bruksanvisning / Manual de instruções*

DXZ448R

RDS-EON FM / MW / LW RADIO CD COMBINATION

COMBINE RADIO FM/PO/GO RDS-EON-LECTEUR DE CD

RDS-EON UKW/MW/LW RADIO-CD-KOMBINATION

**COMBINAZIONE DI RADIO RDS-EON FM/MW/LW E
LETTORE CD**

RDS-EON FM/MW/LW RADIO CD COMBINATIE

**COMBINACIÓN DE RADIO RDS-EON DE FM/MW/LW Y
REPRODUCTOR DE CD**

**KOMBINERAD FM/MV/LV-RADIO MED RDS-EON OCH CD-
SPELARE**

COMBINAÇÃO DE CD COM RÁDIO FM/MW/LW RDS-EON

SONET

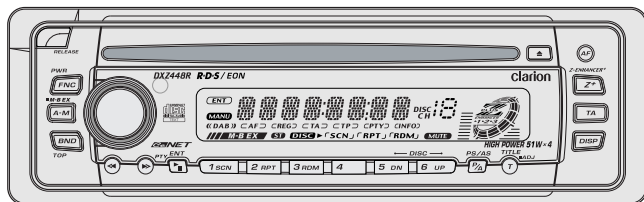

Thank you for purchasing this **Clarion** product.

- * Please read this owner's manual in its entirety before operating this equipment.
- * After reading this manual, be sure to keep it in a handy place (e.g., glove compartment).
- * Check the contents of the enclosed warranty card and keep it carefully with this manual.
- * This manual includes the operating procedures of the CD changer, DVD changer, DAB and TV tuner connected via the CeNET cable. The CD changer, DVD changer and TV tuner have their own manuals, but no explanations for operating them are described.

CAUTIONS:

This appliance contains a laser system and is classified as a "CLASS 1 LASER PRODUCT". To use this model properly, read this Owner's Manual carefully and keep this manual for your future reference. In case of any trouble with this player, please contact your nearest "AUTHORIZED service station". To prevent direct exposure to the laser beam, do not try to open the enclosure.

!CAUTION

USE OF CONTROLS OR ADJUSTMENTS OR PERFORMANCE OF PROCEDURES OTHER THAN THOSE SPECIFIED IN THE OWNER'S MANUAL MAY RESULT IN HAZARDOUS RADIATION EXPOSURE.

ADVARSEL.

Denne mærking er anbragt udvendigt på apparatet og indikerer, at apparatet arbejder med laserstråler af klasse 1, hvilket betyder, at der anvendes laserstråler af svageste klasse, og at man ikke på apparatets yderside kan blive udsat for utilsladelig kraftig stråling.

APPARATET BØR KUN ÅBNES AF FAGFOLK MED SÆRLIGT KENDSKAB TIL APPARATER MED LASERSTRÅLER!

Indvendigt i apparatet er anbragt den her gengivne advarselmærkning, som advarer imod at foretage sådanne indgreb i apparatet, at man kan komme til at udsætte sig for laserstråling.

OBS!

Apparatet innehåller laserkomponenten som avger laserstrålning överstigande gränsen för laserklass 1.

VAROITUS

Suojakoteloä si saa avata. Laite sisältää laserdiodin, joka lähettää näkymätöntä silmille vaarallista lasersäteilyä.

MODEL	<input type="text"/>	Clarion
12V \ominus GROUND		
LW	153-279kHz	
MW	531-1602kHz	
FM(UKW)	87.5-108MHz	
This unit is designed for on-road vehicle purpose.		
CLASS 1 LASER PRODUCT		
		PEC <input type="text"/> 2964 <input type="text"/> Clarion Co., Ltd. MADE IN <input type="text"/>

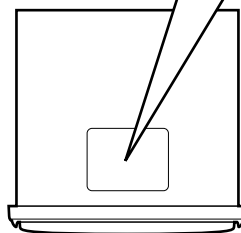

- ENT** : Enter indication
- MANU** : Manual indication

Operation status indication
Titles, PS names, PTYs, CT (clock), etc.
are displays.

Preset channel indication (1 to 6)
Disc number indication (1 to 12)

Z-Enhancer Plus indication



- «DAB»** : DAB indication
- CAF** : Alternative frequency indication
- CREG** : Regional indication
- CTAF** : Traffic announcement indication
- CTP** : Traffic programme indication
- CPTY** : Programme type indication
- CINFO** : Information indication for DAB

- M-B EX** : MAGNA BASS EXTEND indication
- ST** : Stereo indication for DAB
- DISC** : Disc indication
- SCN** : Scan indication
- RPT** : Repeat indication
- RDM** : Random indication
- MUTE** : Mute indication

LCD Screen

In extreme cold, the screen movement may slow down and the screen may darken, but this is normal. The screen will recover when it returns to normal temperature.

Contents

1. PRECAUTIONS	3
Handling Compact Discs	4
2. CONTROLS	5
3. NOMENCLATURE	6
Names of the Buttons and Their Functions	6
Major Button Operations When External Equipment is Connected to This Unit	7
Display Items	8
LCD Screen	8
4. DCP	9
5. REMOTE CONTROL (Optional)	10
Inserting the Batteries	10
Functions of Remote Control Unit Buttons	11
6. OPERATIONS	12
Basic Operations	12
Radio Operations	14
RDS Operations	16
CD Operations	19
Operations Common to Each Mode	21
7. OPERATIONS OF ACCESSORIES	24
CD Changer Operations	24
TV Operations	26
Digital Radio/DAB Operations	27
8. IN CASE OF DIFFICULTY	31
9. ERROR DISPLAYS	32
10. SPECIFICATIONS	33

1. PRECAUTIONS

- This unit is applicable for on-road 4 wheel vehicle purpose only. Use for tractor, fork truck, bulldozer, off road vehicle, 2 or 3 wheel motor bicycle, marine boat or other special purpose vehicle is not appropriate.
- When the inside of the car is very cold and the player is used soon after switching on the heater moisture may form on the disc or the optical parts of the player and proper playback may not be possible. If moisture forms on the disc, wipe it off with a soft cloth. If moisture forms on the optical parts of the player, do not use the player for about one hour. The condensation will disappear naturally allowing normal operation.

- Driving on extremely bumpy roads which cause severe vibration may cause the sound to skip.

INFORMATION FOR USERS:
CHANGES OR MODIFICATIONS TO THIS PRODUCT NOT APPROVED BY THE MANUFACTURER WILL VOID THE WARRANTY.

Handling Compact Discs

Use only compact discs bearing the or mark.

Do not play heart-shaped, octagonal, or other specially shaped compact discs.

Some CDs recorded in CD-R/CD-RW mode may not be usable.

Handling

- Compared to ordinary music CDs, CD-R and CD-RW discs are both easily affected by high temperature and humidity and some of CD-R and CD-RW discs may not be played. Therefore, do not leave them for a long time in the car.
- New discs may have some roughness around the edges. If such discs are used, the player may not work or the sound may skip. Use a ball-point pen or the like to remove any roughness from the edge of the disc.

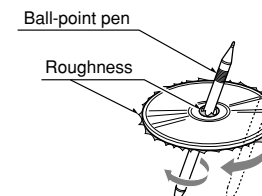

- Never stick labels on the surface of the compact disc or mark the surface with a pencil or pen.
- Never play a compact disc with any cellophane tape or other glue on it or with peeling off marks. If you try to play such a compact disc, you may not be able to get it back out of the CD player or it may damage the CD player.
- Do not use compact discs that have large scratches, are misshapen, cracked, etc. Use of such discs may cause misoperation or damage.
- To remove a compact disc from its storage case, press down on the center of the case and lift the disc out, holding it carefully by the edges.

- Do not use commercially available CD protection sheets or discs equipped with stabilizers, etc. These may damage the disc or cause breakdown of the internal mechanism.

Storage

- Do not expose compact discs to direct sunlight or any heat source.
- Do not expose compact discs to excess humidity or dust.
- Do not expose compact discs to direct heat from heaters.

Cleaning

- To remove fingermarks and dust, use a soft cloth and wipe in a straight line from the center of the compact disc to the circumference.
- Do not use any solvents, such as commercially available cleaners, anti-static spray, or thinner to clean compact discs.
- After using special compact disc cleaner, let the compact disc dry off well before playing it.

4. DCP

The control panel can be detached to prevent theft. When detaching the control panel, store it in the DCP (DETACHABLE CONTROL PANEL) case to prevent scratches.

We recommend taking the DCP with you when leaving the car.

Removing the DCP

1. Press the **[FNC]** button for 1 second or longer to switch off the power.
2. Press the **[RELEASE]** button.

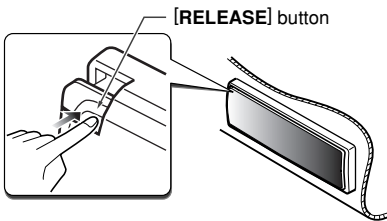

* The DCP is unlocked

3. Remove the DCP.

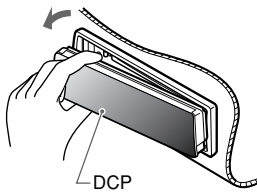

Attaching the DCP

1. Insert the right side of the DCP into the main unit.
2. Insert the left side of the DCP into the main unit.

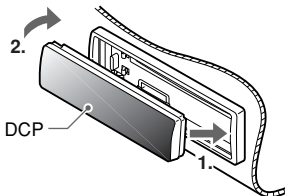

Storing the DCP in the DCP Case

Hold the DCP, in the orientation as shown in the figure below, and put it into the supplied DCP case. (Ensure the DCP is in the correct orientation.)

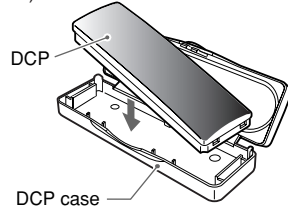

⚠ CAUTION

- The DCP can easily be damaged by shocks. After removing it, be careful not to drop it or subject it to strong shocks.
- When the Release button is pressed and the DCP is unlocked, the car's vibrations may cause it to fall. To prevent damage to the DCP, always store it in its case after detaching it. (see figure below.)
- The connector connecting the main unit and the DCP is an extremely important part. Be careful not to damage it by pressing on it with fingernails, screwdrivers, etc.

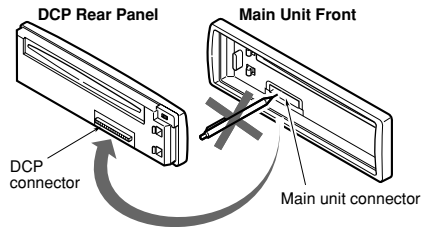

Note:

- If the DCP is dirty, wipe off the dirt with a soft, dry cloth only.

5. REMOTE CONTROL (Optional)

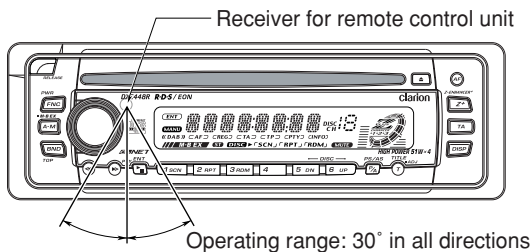

If you buy the RCB-164 sold separately, you can enjoy the use of the Remote Control function.

Signal transmitter

Remote control unit

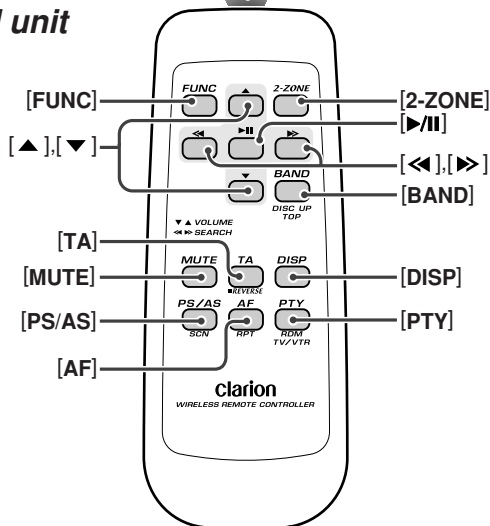

Inserting the Batteries

1. Turn the remote control unit over, then slide the rear cover in the direction of the arrow.
2. Insert the AA (SUM-3, IECR-6/1.5V) batteries that came with the remote control unit facing in the directions shown in the figure, then close the rear cover.

Notes:

Using batteries improperly can cause them to explode. Take note of the following points:

- When replacing batteries, replace both batteries with new ones.
- Do not short-circuit, disassemble or heat batteries.
- Do not dispose of batteries into fire or flames.
- Dispose of spent batteries properly.

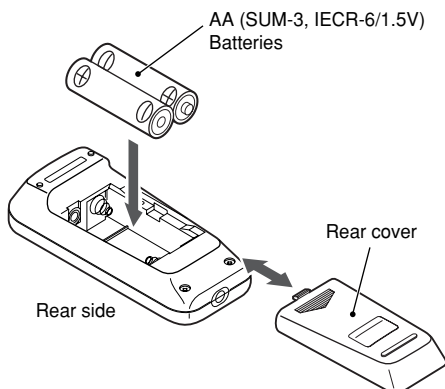

Functions of Remote Control Unit Buttons

Mode Button	Radio (RDS) / DAB	CD	CD changer DVD changer	TV
[FUNC]	Switches among radio, DAB, CD, CD changer, DVD changer and TV.			
[BAND]	Switches reception band.	Plays the first track. Top play.	Moves the next disc in increasing order.	Switches reception band.
[▲], [▼]	Increases and decreases volume (in all modes).			
[◀], [▶]	Moves preset channels up and down.	Moves tracks up and down. When pressed and held for 1 second or longer: Fast-forward/fast-backward.		Moves preset channels up and down.
[▶/II]	No function.	Switches between playback and pause.		No function.
[MUTE]	Turns mute on and off.			
[TA]	TA on and off.			
[DISP]	Switches among main display, sub display, clock (CT) display.			
[PS/AS]	Preset scan. When pressed and held for 2 seconds or longer: Auto store.	Scan play.	Scan play. When pressed and held for 1 second or longer: Disc scan play.	Preset scan. When pressed and held for 2 seconds or longer: Auto store.
[AF]	AF function on and off. When pressed and held for 1 second or longer: REG function on and off	Repeat play.	Repeat play. When pressed and held for 1 second or longer: Disc repeat play.	No function.
[PTY]	PTY standby mode on and off.	Random play.	Random play. When pressed and held for 1 second or longer: Disc random play.	Switches between TV and VTR.

* Some of the corresponding buttons on the main unit and remote control unit have different functions.

* [2-ZONE] button is not available.

6. OPERATIONS

Basic Operations

Note: Be sure to read this chapter referring to the front diagrams of chapter "2. CONTROLS" on page 5 (unfold).

⚠ CAUTION

Be sure to lower the volume before switching off the unit power or the ignition key. The unit remembers its last volume setting. If you switch the power off with the volume up, when you switch the power back on, the sudden loud volume may hurt your hearing and damage the unit.

Turning on/off the power

Note:

- Be careful about using this unit for a long time without running the engine. If you drain the car's battery too far, you may not be able to start the engine and this can reduce the service life of the battery.

1. Press the [FNC] button.
2. The illumination and display on the unit light up. The unit automatically remembers its last operation mode and will automatically switch to display that mode.
3. Press and hold the [FNC] button for 1 second or longer to turn off the power for the unit.

Note:

- System check

The first time this unit is turned on after the wire connections are completed, it must be checked what equipment is connected. When the power is turned on, "SYSTEM" and "PUSH PWR" appear in the display alternately, so press the [FNC] button. The system check starts within the unit. When the system check is complete, press the [FNC] button again.

Selecting a mode

1. Press the [FNC] button to change the operation mode.
2. Each time you press the [FNC] button, the operation mode changes in the following order:
Radio mode → DAB mode → CD mode → CD changer mode → DVD changer mode → TV mode → Radio mode...
* External equipment not connected with CeNET is not displayed.

Adjusting the volume

Turning the [ROTARY] knob clockwise increases the volume; turning it counterclockwise decreases the volume.

- * The volume level is from 0 (minimum) to 33 (maximum).

Switching the display

Press the [DISP] button to select the desired display.

Each time you press the [DISP] button, the display switches in the following order:

Main display

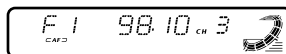

Sub display

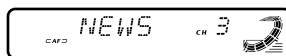

Clock (CT) display

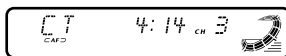

Main display

- * Once selected, the preferred display becomes the display default. When a function adjustment such as volume is made, the screen will momentarily switch to that function's display, then revert back to the preferred display several seconds after the adjustment.
- * For information on how to enter a title, refer to the subsection "Entering titles" in section "Operations Common to Each Mode".
- * When CT data is not received, "CT—:—" appears in the display.

Setting the Z-Enhancer Plus

This unit are provided with 4 types of sound tone effects stored in memory. Select the one you prefer.

- * The factory default setting is "Z+ OFF".

Each time you press the [Z+] button, the tone effect changes in the following order:

“Z+ OFF” → “B-BOOST” → “IMPACT” →
“EXCITE” → “CUSTOM” → “Z+ OFF” ...

- B-BOOST : bass emphasized
- IMPACT : bass and treble emphasized
- EXCITE : bass and treble emphasized mid de-emphasized
- CUSTOM : user custom
- Z+ OFF : no sound effect

Adjusting the tone

Press the [A-M] button and select the item to adjust. Each time you press the [A-M] button, the item changes as following order:

● When “B-BOOST” is set

“B-BOOST” → “BAL 0” → “FAD 0” → Last function mode

● When “IMPACT” is set

“IMPACT” → “BAL 0” → “FAD 0” → Last function mode

● When “EXCITE” is set

“EXCITE” → “BAL 0” → “FAD 0” → Last function mode

● When “CUSTOM” is set

“BASS” → “TREBLE” → “BAL 0” → “FAD 0” → Last function mode

● When “Z+ OFF” is set

“BAL 0” → “FAD 0” → Last function mode

Adjusting the bass (Gain, Frequency, Q-curve)

This adjustment can be performed when the Z-Enhancer Plus is set to “CUSTOM”.

1. Press the [A-M] button and select “BASS”.
2. Turning the [ROTARY] knob clockwise emphasizes the bass; turning it counterclockwise attenuates the bass.
 - * The factory default setting is “B<G 0>”. (Adjustment range: -6 to +6)
3. Press the [◀] or [▶] button to select “B<F 60>”.

Turning the [ROTARY] knob clockwise or counterclockwise to select the frequency.

 - * The factory default setting is “B<F 60>”. (Adjustment 60/100/200 Hz)
4. Press the [◀] or [▶] button to select “B<Q 1>”.

Turning the [ROTARY] knob clockwise or counterclockwise to select the Q-curve.

* The factory default setting is “B<Q 1>”. (Adjustment 1/1.25/1.5/2)

5. When the adjustment is complete, press the [A-M] button several times until the function mode is reached.

Adjusting the treble (Gain, Frequency)

This adjustment can be performed when the Z-Enhancer Plus is set to “CUSTOM”.

1. Press the [A-M] button and select “TREBLE”.
2. Turning the [ROTARY] knob clockwise emphasizes the treble; turning it counterclockwise attenuates the treble.
 - * The factory default setting is “T<G 0>”. (Adjustment range: -6 to +6)
3. Press the [◀] or [▶] button to select “T<F 10>”.

Turning the [ROTARY] knob clockwise or counterclockwise to select the frequency.

 - * The factory default setting is “T<F 10>”. (Adjustment 10 kHz/15 kHz)
4. When the adjustment is complete, press the [A-M] button several times until the function mode is reached.

Adjusting the balance

1. Press the [A-M] button and select “BAL 0”.
2. Turning the [ROTARY] knob clockwise emphasizes the sound from the right speaker; turning it counterclockwise emphasizes the sound from the left speaker.
 - * The factory default setting is “BAL 0”. (Adjustment range: L13 to R13)
3. When the adjustment is complete, press the [A-M] button several times until the function mode is reached.

Adjusting the fader

1. Press the [A-M] button and select “FAD 0”.
2. Turning the [ROTARY] knob clockwise emphasizes the sound from the front speakers; turning it counterclockwise emphasizes the sound from the rear speakers.
 - * The factory default setting is “FAD 0”. (Adjustment range: F12 to R12)
3. When the adjustment is complete, press the [A-M] button several times until the function mode is reached.

Basic Operations

Adjusting the Z-Enhancer Plus

1. Press the **[Z+]** button and select the Z-Enhancer Plus mode to adjust.
 2. Press the **[A-M]** button and turning the **[ROTARY]** knob clockwise adjusts in the + direction; turning it counterclockwise adjusts in the – direction.
 - When “**B-BST 0**” is selected, you can adjust the bass in the range of –3 to 3.
 - When “**IMPACT 0**” is selected, you can adjust the bass and treble in the range of –3 to 3.
 - When “**EXCITE 0**” is selected, you can adjust the bass and treble in the range of –3 to 3.
- * Press and hold the **[Z+]** button for 2 seconds or longer to change to the “**CUSTOM**” mode. Bass/treble characteristics become flat and the indication “**Z+ FLAT**” is shown in the display.
- Press the **[Z+]** button again to change to the “**Z+ OFF**” mode.

Adjusting MAGNA BASS EXTEND

The MAGNA BASS EXTEND does not adjust the low sound area like the normal sound adjustment function, but emphasizes the deep bass sound area to provide you with a dynamic sound.

1. Press and hold the **[A-M]** button for 1 second or longer to turn on the MAGNA BASS EXTEND effect. “**M-B EX**” lights in the display.
2. Press and hold the **[A-M]** button for 1 second or longer to turn off the MAGNA BASS EXTEND effect. “**M-B EX**” goes off from the display.
 - * The factory default setting is off.

CT (Clock Time) function

The CT function receives CT data sent from a RDS station and displays the time. Press the **[DISP]** button to switch to the CT display.

- * If a CT data is not being received, “**CT—:—**” appears in the display.

Note:

- CT data is not transmitted in some countries and by some broadcast stations. Also, in some areas, the CT may not display accurately.

Radio Operations

Listening to the radio

1. Press the **[FNC]** button and select the radio mode. The frequency or PS appears in the display.
 - * PS: Programme service name
2. Press the **[BND]** button and select the radio band. Each time the button is pressed, the radio reception band changes in the following order:
FM1 → FM2 → FM3 → AM (MW/LW) → FM1...
3. Press the **[◀▶]** or **[▶▶]** button to tune in the desired station.

Tuning

There are 3 types of tuning mode available, seek tuning, manual tuning and preset tuning.

Seek tuning

There are 2 types of seek tuning: DX SEEK and LOCAL SEEK.

DX SEEK can automatically tune in to receivable broadcast stations; LOCAL SEEK can tune in to only broadcast stations with a good reception sensitivity.

1. Press the **[BND]** button and select the desired band (FM or AM (MW, LW)).
2. Tune into a station.
 - * If “**MANU**” is lit in the display, press and hold the **[BND]** button for 1 second or longer. “**MANU**” in the display goes off and seek tuning is now available.
 - * If “**TA**” is lit in the display, TP stations are automatically sought.

● DX SEEK

Press the **[◀▶]** or **[▶▶]** button to automatically seek a station.

When the **[▶▶]** button is pressed, the station is sought in the direction of higher frequencies; if the **[◀▶]** button is pressed, the station is sought in the direction of lower frequencies.

- * When seek tuning starts, “**DX**” appears in the display.

● LOCAL SEEK

If you press and hold the **[◀▶]** or **[▶▶]** button for 1 second or longer, local seek tuning is carried out. Broadcast stations with good reception sensitivity are selected.

- * When local seeking starts, “**LO**” appears in the display.

Manual tuning

There are 2 ways available: Quick tuning and step tuning.

When you are in the step tuning mode, the frequency changes one step at a time. In the quick tuning mode, you can quickly tune the desired frequency.

1. Press the **[BND]** button and select the desired band (FM or AM (MW/LW)).
 - * If "MANU" is not lit in the display, press and hold the **[BND]** button for 1 second or longer. "MANU" is lit in the display and manual tuning is now available.
2. Tune in a station.

● Quick tuning:

Press and hold the [**◀**] or [**▶**] button for 1 second or longer to tune in a station.

● Step tuning:

Press the [**◀**] or [**▶**] button to manually tune in a station.

- * If no operation is performed for more than 7 seconds, manual tuning is cancelled and the display returns to the previous mode.

Recalling a preset station

A total of 24 preset positions (6-FM1, 6-FM2, 6-FM3, 6-AM) exist to store individual radio stations in memory. Pressing the corresponding **[DIRECT]** button recalls the stored radio frequency automatically.

1. Press the **[BND]** button and select the desired band (FM or AM (MW/LW)).
2. Press the corresponding **[DIRECT]** button to recall the stored station.
 - * Press and hold one of the **[DIRECT]** buttons for 2 seconds or longer to store that station into preset memory.

Manual memory

1. Select the desired station with seek tuning, manual tuning or preset tuning.
2. Press and hold one of the **[DIRECT]** buttons for 2 seconds or longer to store the current station into preset memory.

Auto store

Auto store is a function for storing up to 6 stations that are automatically tuned in sequentially. If 6 receivable stations cannot be received, a previously stored station remains unoverwritten at the memory position.

1. Press the **[BND]** button and select the desired band (FM or AM (MW/LW)).
2. Press and hold the **[P/A]** button for 2 seconds or longer. The stations with good reception are stored automatically to the preset channels.
 - * If auto store is performed in the FM bands, the stations are stored in FM3 even if FM1 or FM2 was chosen for storing stations.

Preset scan

Preset scan receives the stations stored in preset memory in order. This function is useful when searching for a desired station in memory.

1. Press the **[P/A]** button.
2. When a desired station is tuned in, press the **[P/A]** button again to continue receiving that station.

Note:

- * Be careful not to press and hold the **[P/A]** button for 2 seconds or longer, otherwise the auto store function is engaged and the unit starts storing stations.

RDS Operations

RDS (Radio Data System)

This unit has a built-in RDS decoder system that supports broadcast stations transmitting RDS data.

This system can display the name of the broadcast station being received (PS) and can automatically switch to the broadcast station with the best reception as you move long distances (AF switching).

Also, if a traffic announcement or programme type is broadcast from an RDS station, no matter what mode you are in, this broadcast is received.

Additionally, if EON information is received, this information enables automatic switching of other preset stations on the same network and interruption of the station being received with traffic information from other stations (TP). This function is not available in some areas.

When using the RDS function, always set the radio to FM mode.

- AF : Alternative Frequency
- PS : Programme Service Name
- PTY : Programme Type
- EON : Enhanced Other Network
- TP : Traffic Programme
- * RDS interrupt does not function during AM radio reception.
- * When set receives RDS signal, and can read PS data, PS appears in the display.

AF function

The AF function switches to a different frequency on the same network in order to maintain optimum reception.

* The factory default setting is "ON".

● Switching OFF the AF function

Press the [AF] button. "AF" in the display goes off and the AF function turns off.

● Switching ON the AF function

Press the [AF] button. "AF" in the display lights and the AF function turns on.

* If the reception of the current broadcast station deteriorates, "SEARCH" appears in the display and the radio searches for the same programme on another frequency.

● AF function between RDS and DAB

When the same programme is broadcasted by both RDS and DAB, and this function is ON, the unit switches to receive the broadcast with the better reception automatically.

- * This function only operates when the DAH913 or DAH923 DAB unit, sold separately, is connected.
- * This factory default setting is "ON".

1. Press and hold the [T] button for 1 second or longer to switch to the adjustment selection display.
2. Press the [◀] or [▶] button to select "LINK ACT".
3. Turn the [ROTARY] knob clockwise for "ON" or counterclockwise for "OFF".
 - ON:
 - AF switching between DAB and RDS enabled.
 - OFF:
 - AF switching between DAB and RDS disabled.
4. Press the [T] button to return to the previous mode.

REG (Regional programme) function

When the REG function is ON, the optimum regional station can be received. When this function is OFF, if the regional station area switches as you drive, a regional station for that region is received.

* The factory default setting is "OFF".

Notes:

- This function is disabled when a national station such as BBC R2 is being received.
- The REG function ON/OFF setting is valid when the AF function is ON.

● Switching the REG function ON

Press and hold the [AF] button for 1 second or longer.

"REG" in the display lights and the REG function turns on.

● Switching the REG function OFF

Press and hold the [AF] button for 1 second or longer.

"REG" in the display goes off and the REG function turns off.

Manually tuning a regional station in the same network

1. This function is valid when the AF function is ON and the REG function is OFF.

Note:

- This function can be used when a regional broadcast of the same network is received.
2. Press any one of the [DIRECT] buttons to call out the regional station.
 3. If the reception condition of the called out station is bad, press the [DIRECT] button of the same number. The unit receives a local station on the same network.

TA (Traffic Announcement)

In the TA standby mode, when a traffic announcement broadcast starts, the traffic announcement broadcast is received as top priority regardless of the function mode so you can listen to it. Traffic programme (TP) automatic tuning is also possible.

* This function can only be used when "TP" is lit in the display. When "TP" is lit, this means that the RDS broadcast station being received has traffic announcement programmes.

● Setting the TA standby mode

If you press the [TA] button when only "TP" is lit in the display, "TP" and "TA" light in the display and the unit is set into the TA standby mode until a traffic announcement is broadcast. When a traffic announcement broadcast starts, "TRA INFO" appears in the display. If you press the [TA] button while a traffic announcement broadcast is being received, the traffic announcement broadcast reception is cancelled and the unit goes into the TA standby mode.

● Cancelling the TA standby mode

As "TP" and "TA" lit in the display, press the [TA] button. The "TA" in the display goes off and the TA standby mode is cancelled.

* If "TP" is not lit, pressing the [TA] button searches for a TP station.

● Searching for a TP station

When "TP" is not lit, if you press the [TA] button, "TA" in the display lights and the unit automatically receives a TP station.

Note:

• If a TP station is not received, the unit continues the search operation. Pressing [TA] button again goes off "TA" in the display and stops TP station searching.

Auto store function for TP stations

You can automatically store up to 6 TP stations into preset memory. If the number of TP can be received less than 6, broadcast stations already stored in memory and left without being overwritten.

As "TA" lit in the display, press and hold the [P/A] button for 2 seconds or longer. The TP stations with the good reception sensitivity are stored into preset memory.

* Even if you select FM1 or FM2, a TP station is stored into memory for FM3.

PTY

This function enables you to listen to a broadcast of the selected programme type even if the unit is on a function mode other than radio.

- * Some countries do not yet have PTY broadcast.
- * In the TA standby mode, a TP station has priority over a PTY broadcast station.

● Setting the PTY standby mode

When you press the [▶||] button, "PTY" lights in the display and the PTY standby mode is turned on. When the selected PTY broadcast starts, the PTY item name appears in the display.

● Cancelling the PTY standby mode

When you press and hold the [▶||] button for 1 second or longer, "PTY" goes off in the display and PTY standby mode is cancelled.

● Cancelling a PTY interrupt broadcast

Press the [▶||] button during the PTY interrupt broadcast, the PTY interrupt is cancelled and the unit returns to PTY standby mode.

Selecting PTY

1. When you press the [▶||] button, the unit goes into PTY select mode.
2. Press any one of the [DIRECT] buttons. Alternatively, turn the [ROTARY] knob clockwise or counterclockwise to select the desired PTY.

* Below are the factory default settings stored for the [DIRECT] buttons.

Preset number	PTY item	
	ENGLISH	Contents
1	NEWS	News
2	INFO	Information
3	POP M	Pop Music
4	SPORT	Sport
5	CLASSICS	Serious Classical Music
6	EASY M	Easy Listening Music

3. The PTY select mode is cancelled automatically 7 seconds after a PTY is selected.

PTY seek

1. When you press the [▶||] button, the PTY select mode is turned on.
2. Select PTY.
3. Press the [◀] or [▶] button. If you press the [▶] button, the unit seeks a PTY broadcast moving up the frequencies; if you press the [◀] button, it seeks moving down the frequencies.

* If no station with the selected PTY broadcast can be received, the unit returns to the previous mode.

RDS Operations

PTY preset memory

1. When you press the [▶|||] button, the PTY select mode is turned on.
2. Turn the [ROTARY] knob clockwise or counterclockwise to select the desired PTY.
The 29 types of PTY below can be selected.

3. If you press and hold any one of the [DIRECT] buttons for 2 seconds or longer, the selected PTY is stored into that preset channel memory.

PTY item				
ENGLISH	GERMAN	SWEDISH	FRENCH	Contents
NEWS	NACHRICHT	NYHETER	INFOS	News
AFFAIRS	AKTUELL	AKTUELLT	MAGAZINE	Today's events
INFO	SERVICE	INFO	SERVICES	Information
SPORT	SPORT	SPORT	SPORT	Sports
EDUCATE	BILDUNG	UTBILDN	EDUCATIF	Education
DRAMA	HÖR+LIT	TEATER	FICTION	Drama
CULTURE	KULTUR	KULTUR	CULTURE	Culture
SCIENCE	WISSEN	VETENSKP	SCIENCES	Science
VARIED	UNTERH	UNDERH	DIVERS	Variety
POP M	POP	POP	M POP	Pop music
ROCK M	ROCK	ROCK	M ROCK	Rock music
EASY M	U-MUSIK	LÄTTLYSS	CHANSONS	Easy music
LIGHT M	L-MUSIK	L KLASS	M CL LëG	Light music
CLASSICS	E- MUSIK	KLASSISK	CLASSIQ	Classics
OTHER M	-- MUSIK	ÖVRIG M	AUTRE M	Other music
WEATHER	WETTER	VÄDER	MëTëO	Weather
FINANCE	WIRTSCH	EKONOMI	ECONOMIE	Finance
CHILDREN	KINDER	FÖR BARN	ENFANTS	For children
SOCIAL	SOZIALES	SOCIALT	SOCIëTë	Social
RELIGION	RELIGION	ANDLIGT	RELIGION	Religion
PHONE IN	ANRUF	TELEFON	FORUM	Phone in
TRAVEL	REISE	RESOR	VOYAGES	Travel
LEISURE	FREIZEIT	FRITID	LOISIRS	Leisure
JAZZ	JAZZ	JAZZ	JAZZ	Jazz
COUNTRY	COUNTRY	COUNTRY	COUNTRY	Country
NATION M	LANDES M	NATION M	CH PAYS	Nation music
OLDIES	OLDIES	OLDIES	RëTRO	Oldies
FOLK M	FOLKLORE	FOLKM	FOLKLORE	Folk music
DOCUMENT	FEATURE	DOKUMENT	DOCUMENT	Documentaries

Emergency broadcast

If an emergency broadcast is received, all the function mode operations are stopped.

“ALARM” appears in the display and the emergency broadcast can be heard.

● Cancelling an emergency broadcast

If you press the [AF] button, emergency broadcast reception is cancelled.

Switching the PTY display language

You can select one of 4 languages (English, German, Swedish or French) for the PTY displayed in the display.

* The factory default setting is “ENGLISH”.

1. Press and hold the [T] button for 1 second or longer to switch to the adjustment selection display.
2. Press the [◀] or [▶] button and select “LANGUAGE”.
3. Press the [▶||] button.
4. Turn the [ROTARY] knob clockwise or counterclockwise to select the desired language.
5. Press the [▶||] button.
6. Press the [T] button to return to the previous mode.

Volume setting of TA, emergency broadcast (ALARM) and PTY

The volume for TA, ALARM and PTY interrupts can be set during TA, ALARM or PTY interrupt.

* The factory default setting is “15”.

During a TA, ALARM or PTY interrupt, turn the [ROTARY] knob clockwise or counterclockwise to set the volume to the desired level (0 to 33).



* When the TA, ALARM or PTY interrupt ends, the volume returns to the level it had before the interrupt.

Loading a CD

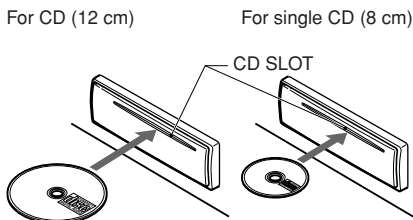
Insert a CD into the centre of the CD SLOT with the labeled side facing up. “LOADING” appears in the display, the CD enters into the slot, and the play starts.



Notes:

- Never insert foreign objects into the CD SLOT.
- If the CD is not inserted easily, there may be another CD in the mechanism or the unit may require service.
- Discs not bearing the  or  mark and CD-ROMs cannot be played by this unit.
- Some CDs recorded in CD-R/CD-RW mode may not be usable.

Loading 8 cm compact discs

- * No adapter is required to play an 8 cm CD.
- * Insert the 8 cm CD into the centre of the insertion slot.

Listening to a CD already inserted

Press the [FNC] button to select the CD mode. Play starts automatically. If no CD is loaded in the unit, “NO DISC” appears in the display.

Pausing play

1. Press the [▶||] button to pause play. “PAUSE” appears in the display.
2. To resume CD play, press the [▶||] button again.

CD Operations

Displaying CD titles

This unit can display title data for CD-text CDs and user titles input with this unit.

1. Press the [DISP] button to display the title.
2. Each time you press and hold the [DISP] button for 1 second or longer, the title display changes in the following order:

User title (disc) → CD-text title (disc) → Artist name → CD-text title (track) → User title (disc)...

Note:

- If the CD playing is not a CD-text CD or no user title has been input, "NO TITLE" appears in the display.

Ejecting a CD

1. Press the [▲] to eject the CD. Take it out from the ejected position.

Note:

- If you force a CD into before auto reloading, this can damage the CD.
- * If a CD (12 cm) is left in the ejected position for 15 seconds, the CD is automatically reloaded (Auto reload).
- * 8 cm CDs are not auto reloaded. Be sure to remove it when ejected.

Selecting a track

● Track-up

1. Press the [▶▶] button to move ahead to the beginning of the next track.
2. Each time you press the [▶▶] button, the track advances ahead to the beginning of the next track.

● Track-down

1. Press the [◀◀] button to move back to the beginning of the current track.
2. Press the [◀◀] button twice to move to the beginning of the previous track.

Fast-forward/fast-backward

● Fast-forward

Press and hold the [▶▶] button for 1 second or longer.

● Fast-backward

Press and hold the [◀◀] button for 1 second or longer.

Top function

The top function resets the CD player to the first track of the disc. Press the [BND] button to play the first track (track No. 1) on the disc.

Scan play

The scan play locates and plays the first 10 seconds of each track on a disc automatically. This function continues on the disc until it is cancelled.

* The scan play is useful when you want to select a desired track.

1. Press the [SCN] button to start scan play. "SCN" lights in the display.
2. To cancel the scan play, press the [SCN] button again. "SCN" goes off from the display and the current track continues to play.

Repeat play

The repeat play continuously plays the current track. This function continues automatically until it is cancelled.

1. Press the [RPT] button. "RPT" lights in the display and the current track is repeated.
2. To cancel the repeat play, press the [RPT] button again. "RPT" goes off from the display and normal play resumes.

Random play

The random play selects and plays individual tracks on a disc in no particular order. This function continues automatically until it is cancelled.

1. Press the [RDM] button. "RDM" lights in the display, an individual track is selected randomly and play begins.
2. To cancel the random play, press the [RDM] button again. "RDM" goes off from the display and normal play resumes.

Operations Common to Each Mode

Dimmer control

You can set the dimmer control "ON" or "OFF".

* The factory default setting is "ON".

1. Press and hold the [T] button for 1 second or longer to switch to the adjustment selection display.
2. Press the [◀] or [▶] button to select "DIMMER".
3. Turn the [ROTARY] knob clockwise or counterclockwise and select "ON" or "OFF".
4. Press the [T] button to return to the previous mode.

Setting the car speaker output for the cellular phone (Optional TEL-002)

* The factory default setting is "RIGHT".

* To output the telephone calls, set the cellular phone interrupt to ON.

1. Press and hold the [T] button for 1 second or longer to switch to the adjustment selection display.
2. Press the [◀] or [▶] button to select "TEL-SP".
3. Turn the [ROTARY] knob clockwise to select "RIGHT" or counterclockwise to select "LEFT".

● RIGHT:

Telephone calls can be heard on the front right speaker connected to this unit.

● LEFT:

Telephone calls can be heard on the front left speaker connected to this unit.

4. Press the [T] button to return to the previous mode.

Cellular phone interrupt setting

If you connect this unit and your cellular phone with a separately sold unit (TEL-002), you can listen to your telephone calls on your car speakers.

* The factory default setting is "OFF".

1. Press and hold the [T] button for 1 second or longer to switch to the adjustment selection display.
2. Press the [◀] or [▶] button to select "TEL-SW".

3. Turn the [ROTARY] knob clockwise or counterclockwise to select the setting. Each time you turn the [ROTARY] knob, the setting changes in the following order:
OFF → ON → MUTE → OFF...

● OFF:

This unit continues normal operation even when the cellular phone is used.

Note:

• If connecting a hands-free kit, please ensure the setting is ON to receive the telephone audio through the system.

● ON:

You can listen to your telephone calls from the speakers connected to this unit.

* When listening to your calls on your car speakers, you can adjust the volume by turning the [ROTARY] knob.

● MUTE:

The sound from this unit is muted during telephone calls.

4. Press the [T] button to return to the previous mode.

Turning the screen saver function on or off

This unit is provided with the screen saver function which allows you to show various kinds of patterns and characters in the Operation Status indication area of the display in a random order. You can turn on and off this function.

If the button operation is performed with the screen saver function on, the operation display corresponding to the button operation is shown for about 30 seconds and the display returns to the screen saver display.

* The factory default setting is "SS".

1. Press and hold the [T] button for 1 second or longer to switch to the adjustment selection display.
2. Press the [◀] or [▶] button and select "SCRN SVR".
3. Press the [▶||] button.
4. Turn the [ROTARY] knob clockwise or counterclockwise to select the setting. Each time you turn the [ROTARY] knob, the setting changes in the following order:
OFF → SS → MESSAGE.
5. Press the [▶||] button to store the setting.
6. Press the [T] button to return to the previous mode.

Operations Common to Each Mode

Entering titles

Titles up to 8 characters long can be stored in memory and displayed for CD, CD changer and TV stations. The number of titles that can be entered for each mode are as follows.

Mode	Number of titles
CD mode	50 titles
TV mode	20 titles

CD changer mode	Number of titles
DCZ628 connected	100 titles
CDC655Tz connected	100 titles
CDC1255z connected	50 titles

1. Press the **[FNC]** button to select the mode you want to enter a title (CD, CD changer or TV).
2. Select and play a CD in the CD changer or tune in to a TV station for which you want to enter the title.
3. Press the **[DISP]** button and display the sub.
4. Press the **[T]** button.
5. Press the **[◀]** or **[▶]** button to move the cursor.
6. Press the **[DISP]** button to select a character. Each time you press the **[DISP]** button, the character changes in the following order:
Capital letters → Numbers → Symbols → Umlaut → Capital letters...
7. Turn the **[ROTARY]** knob to select the desired character.
8. Repeat steps 5 to 7 to enter up to 8 characters for the title.
9. Press and hold the **[▶▶▶]** button for 2 seconds or longer to store the title into memory and cancel title input mode.

Clearing titles

1. Select and play a CD in the CD changer or tune in to a TV station for which you want to clear the title.
2. Press the **[DISP]** button and display the sub.
3. Press the **[T]** button and switch the display to the title input display.
4. Press the **[BND]** button.
5. Press and hold the **[▶▶▶]** button for 2 seconds or longer to clear the title and cancel title input mode.

Setting the method for title scroll

Set how to scroll in CD-TEXT.

* The factory default setting is "ON".

1. Press and hold the **[T]** button for 1 second or longer to switch to the adjustment selection display.
2. Press the **[◀]** or **[▶]** button and select "SCROLL".
3. Turn the **[ROTARY]** knob clockwise or counterclockwise and select "ON" or "OFF".
 - **ON:**
To scroll automatically.
 - **OFF:**
To scroll just 1 time when the title was changed or the title key was pressed.
4. Press the **[T]** button to return to the previous mode.

Selecting the CONTRAST mode

* The factory default setting is "5".

1. Press and hold the button **[T]** for 1 second or longer to switch to the adjustment selection display.
2. Press the **[◀]** or **[▶]** button to select "CONTRAST".
3. Turn the **[ROTARY]** knob to select from 1-8.
4. Press the **[T]** button to return to the previous mode.

Entering MESSAGE INFORMATION

Message up to 30 characters long can be stored in memory and displayed as a type of screen saver setting.

* The factory default setting is "WELCOME TO CLARION".

1. Press and hold the **[T]** button for 1 second or longer to switch to the adjustment selection display.
2. Press the **[◀]** or **[▶]** button and select "INPUT".
3. Press the **[▶▶▶]** button.
4. Press the **[◀]** or **[▶]** button to move the cursor.
5. Press the **[DISP]** button to select a character. Each time you press the **[DISP]** button, the character changes in the following orders:
Capital letters → Numbers → Symbols → Umlaut → Capital letters...

6. Turn the **[ROTARY]** knob to select the desired character.
7. Repeat step 4 to 6 to enter up to 30 characters for message.
8. Press and hold the **[▶|||]** button for 2 seconds or longer to store the message in memory and cancel input message mode.
 - * Press the **[BND]** button can cancel the input message. Then press and hold the **[▶|||]** button for 2 seconds or longer to store the message and the message return to default setting.
9. Press the **[T]** button to return to the previous mode.

7. OPERATIONS OF ACCESSORIES

CD Changer Operations

CD changer functions

When an optional CD changer is connected through the CeNET cable, this unit controls all CD changer functions. This unit can control a total of 2 changers.

Press the [FNC] button and select the CD changer mode to start play. If 2 CD changers are connected, press the [FNC] button to select the CD changer for play.

* If “NO MAG” appears in the display, insert the magazine into the CD changer. “DISC CHK” appears in the display while the player loads (checks) the magazine.

* If “NO DISC” appears in the display, eject the magazine and insert discs into each slot. Then, reinsert the magazine back into the CD changer.

Note:

• Some CDs recorded in CD-R/CD-RW mode may not be usable.

⚠ CAUTION

CD-ROM discs cannot be played from every CD changer, it's depended on the model.

Pausing play

1. Press the [▶||] button to pause play. “PAUSE” appears in the display.
2. To resume play, press the [▶||] button again.

Displaying CD titles

This unit can display title data for CD-text CDs and user titles input with this unit.

* Title data for CD-text CDs can be displayed with this unit only when it is connected to CDC655Tz.

● When connected to DCZ628 or CDC1255z.

Press the [DISP] button to display the title.

● When connected to CDC655Tz

1. Press the [DISP] button to display the title.
2. Each time you press and hold the [DISP] button for 1 second or longer, the title display changes in the following order:
User title (disc) → CD-text title (disc) → Artist name → CD-text title (track) → User title (disc)...

Notes:

- If the CD playing is not a CD-text CD or no user title has been input, “NO TITLE” appears in the display.
- If a CD-text CD is not input its disc title or a track title, “NO TITLE” appears in the display.

Procedure to scroll a title

Set “SCROLL” to “ON” or “OFF”.

(The factory default setting is “ON”. Refer to the subsection “Turning the screen saver function on or off” in section “Operation common to each mode”.)

● When set to “ON”

The title is automatically kept scrolling.

● When set to “OFF”

To scroll just 1 time when the title was changed or the [T] button was pressed.

Selecting a CD

Press the [DN] or the [UP] button to select the desired disc.

* If a CD is not loaded in a slot of magazine, pressing the [UP] or the [DN] button cannot work.

Selecting a track

● Track-up

1. Press the [▶▶] button to move ahead to the beginning of the next track.
2. Each time you press the [▶▶] button, the track advances ahead to the beginning of the next track.

● Track-down

1. Press the [◀◀] button to move back to the beginning of the current track.
2. Press the [◀◀] button twice to move to the beginning of the previous track.

Fast-forward/fast-backward

● Fast-forward

Press and hold the [▶▶] button for 1 second or longer.

● Fast-backward

Press and hold the [◀◀] button for 1 second or longer.

Scan play

Scan play locates and plays the first 10 seconds of each track on a disc automatically. This function continues on the disc until it is cancelled.

* The scan play is useful when you want to select a desired track.

1. Press the **[SCN]** button to start track scanning. "**SCN**" lights in the display.
2. To cancel the scan play, press the **[SCN]** button again. "**SCN**" goes off from the display and the current track continues to play.

Disc scan play

Disc scan play locates and plays the first 10 seconds of the first track on each disc in the currently selected CD changer. This function continues automatically until it is cancelled.

* Disc scan play is useful when you want to select a desired CD.

1. Press and hold the **[SCN]** button for 1 second or longer. "**DISC**" and "**SCN**" light in the display and disc scan play starts.
2. To cancel disc scan play, press the **[SCN]** button again. "**DISC**" and "**SCN**" go off from the display and the current track continues to play.

Repeat play

Repeat play continuously plays the current track. This function continues automatically until it is cancelled.

1. Press the **[RPT]** button. "**RPT**" lights in the display and the current track is repeated.
2. To cancel repeat play, press the **[RPT]** button again. "**RPT**" goes off from the display and normal play resumes.

Disc repeat play

After all the tracks on the current disc have been played, disc repeat play automatically replays the current disc over from the first track. This function continues automatically until it is cancelled.

1. Press and hold the **[RPT]** button for 1 second or longer. "**DISC**" and "**RPT**" light in the display and disc repeat play starts.
2. To cancel disc repeat play, press the **[RPT]** button again. "**DISC**" and "**RPT**" go off from the display and normal play resumes on the current track.

Random play

Random play selects and plays individual tracks on the disc in no particular order. This function continues automatically until it is cancelled.

1. Press the **[RDM]** button. "**RDM**" lights in the display and random play begins.
2. To cancel random play, press the **[RDM]** button again. "**RDM**" goes off from the display and normal play resumes.

Disc random play

The disc random play selects and plays individual tracks or discs automatically in no particular order. This function continues automatically until it is cancelled.

1. Press and hold the **[RDM]** button for 1 second or longer. "**DISC**" and "**RDM**" light in the display and disc random play starts.
2. To cancel disc random play, press the **[RDM]** button again. "**DISC**" and "**RDM**" go off from the display and normal play resumes from the current track.

TV Operations

TV tuner functions

When an optional TV tuner is connected through the CeNET cable, this unit controls all TV tuner functions. To watch TV requires a TV tuner and monitor.

Watching a TV

1. Press the **[FNC]** button and select the TV mode.
2. Press the **[BND]** button to select the desired TV band (TV1 or TV2). Each time the button is pressed, the input selection toggles between TV1 and TV2.
3. Press the **[◀▶]** or **[▶▶]** button to tune in the desired TV station.

Watching a video

The TV tuner has a VTR input terminal to which 1 external device can be connected. Connect a 12 V video cassette player (VCP) or video cassette recorder (VCR) to the TV tuner input terminal.

1. Press the **[▶||]** button to select VTR.
2. To return to the TV broadcast, press the **[▶||]** button.

Tuning

There are 3 types of tuning mode available, Seek tuning, manual tuning and preset tuning.

Seek tuning

1. Press the **[BND]** button and select the desired TV band (TV1 or TV2).
 - * If "MANU" is lit in the display, press and hold the **[BND]** button for 1 second or longer. "MANU" in the display goes off and seek tuning is now available.
2. Press the **[◀▶]** or **[▶▶]** button to automatically seek a station. Press the **[▶▶]** button to automatically tune up the frequency band to the next available TV station; press the **[◀▶]** button to automatically tune down.

Manual tuning

There are 2 ways available: Quick tuning and step tuning.

When you are in the step tuning mode, the frequency changes one step at a time. In the quick tuning mode, you can quickly tune the desired frequency.

1. Press the **[BND]** button and select the desired band (TV1 or TV2).
 - * If "MANU" is not lit in the display, press and hold the **[BND]** button for 1 second or longer. "MANU" lights in the display and manual tuning is now available.

2. Tune into a station.

● Quick tuning:

Press and hold the **[◀▶]** or **[▶▶]** button for 1 second or longer to tune in a station.

● Step tuning:

Press the **[◀▶]** or **[▶▶]** button to manually tune in a station.

* If no operation is performed for more than 7 seconds, manual tuning is cancelled and the display returns to the previous mode.

Recalling a preset station

A total of 12 TV stations can be stored (6-TV1 and 6-TV2). This allows you to select your favorite TV stations and store them in memory for later recall.

1. Press the **[BND]** button and select the desired TV band (TV1 or TV2).
2. To recall a stored TV station, press the desired **[DIRECT]** button to select that station.
 - * Press and hold one of the **[DIRECT]** buttons for 2 seconds or longer to store the current station into preset memory.

Manual memory

1. Select the desired station with seek tuning, manual tuning or preset tuning.
2. Press and hold one of **[DIRECT]** buttons for 2 seconds or longer to store the current station into preset memory.

Auto store

Auto store selects 6 TV stations automatically and stores each one into preset memory.

If there are not 6 stations with good reception, stations previously stored in memory remain and only the strong stations are stored into memory.

1. Press the **[BND]** button and select the desired TV band (TV1 or TV2).
2. Press and hold the **[P/A]** button for 2 seconds or longer. The stations with good reception are stored automatically to the preset channels.

Preset scan

Preset scan allows the user to view each preset position before it automatically advances to the next preset. This function is useful for searching for a desired TV station in memory.

1. Press the [P/A] button.
2. When the desired station is found, press the [P/A] button again to remain tuned to that station.

Note:

- Do not press and hold the [P/A] button for 2 seconds or longer. Doing so will trigger the auto store function and start storing stations into memory.

Setting the TV area

When you select the TV area (TV reception area), the TV tuner area setting changes.

1. Press and hold the [T] button for 1 second or longer to switch to the adjustment selection display.
2. Press the [◀] or [▶] button to select "TV AREA".
3. Press the [▶||] button.
4. Turn the [ROTARY] knob clockwise or counterclockwise to select the reception area.
5. Press the [▶||] button.
6. Press the [T] button to return to the previous mode.

Setting the TV diver

You can change the reception setting for the TV antenna connected to the TV tuner.

1. Press and hold the [T] button for 1 second or longer to switch to the adjustment selection display.
2. Press the [◀] or [▶] button to select "TV DIVER".
3. Turn the [ROTARY] knob clockwise to set to "ON" or counterclockwise to set to "OFF".
 - **ON:**
Sets reception emphasizing the visual.
 - **OFF:**
Sets the diver setting to OFF.
4. Press the [T] button to return to the previous mode.

DAB control function

When a CeNET cable is used to connect a DAB (DAH913 or DAH923) (sold separately), all functions can be operated.

Listening to the DAB station

1. Press the [FNC] button to select the DAB mode.
2. When the unit receives a DAB station, the display changes in the following order:
Frequency channel → service label

M1 128ch



88C 1 FM

Switching displays

Press the [DISP] button to select the desired display.

Each time you press the [DISP] button, the display switches in the following order:

Main display

M1 128ch



Sub display

NEWS



Clock (CT) display

CT --:--



Main display

Note:

- The display shown in the normal reception mode and the preset reception mode is the same when a DAB station is received.

3. When the unit does not receive a DAB station, the display changes in the following order:

–Normal reception mode–

M1 LE ch

–Preset reception mode–

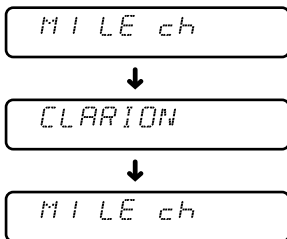

Notes:

- The number of programmes and broadcasting times depend on the DAB stations.
- When the strength of DAB signals is weak, audio output is muted.

Seek tuning

1. Press the **[FNC]** button to select the DAB mode.
2. Press and hold the **[◀]** or **[▶]** button for 1 second or longer.

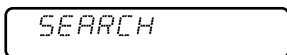

* "SEARCH" appears in the display.

3. "DAB" lights up in the display when the main unit receives a DAB station.

* The main unit stops the seek tuning when it cannot find a DAB station. The display returns to the previous mode.

Manual tuning

1. Press the **[FNC]** button to select the DAB mode.
2. Press and hold the **[BND]** button for 1 second or longer. "MANU" lights up in the display.
3. Press the **[◀]** or **[▶]** button to select a station.

* If no operation is performed for more than 7 seconds, manual tuning is cancelled and the display returns to the previous mode.

Switching programmes

1. Press the **[FNC]** button to receive a DAB station.
2. Press the **[◀]** or **[▶]** button to switch programmes in the DAB station.

Note:

- The programme name may be the same depending on DAB programmes.

Programme scan

This function scans through each receivable programme in a DAB station being received for 10 seconds sequentially. This is useful when you want to search for a desired programme.

1. Press the **[FNC]** button to receive a DAB station.
2. Perform the following operation depending on the connected model.

Press the **[P/A]** button. "SERV SCN" lights up and the unit starts scanning each programme for 10 seconds sequentially. Each time the main unit scans, the programme name is shown in the display.

3. To stop programme scan when a desired programme is tuned in.

Press the **[P/A]** button.

Manual memory

The main unit has a manual memory function for DAB programmes. Up to 18 programmes (6 programmes each) can be preset in the preset buttons.

[M1], [M2] and [M3]

1. Press the **[FNC]** button to select the DAB mode.
2. Press the **[BND]** button to select any one shown above.
3. Press the **[◀]** or **[▶]** button to select a desired programme.
4. Press and hold one of the **[DIRECT]** buttons (1 to 6) for 2 seconds or longer to store the programme.

Note:

- The interrupt programme (PTY or INFO) cannot be written into a manual memory.

Recalling a preset programme

1. Press the **[FNC]** button to select the DAB mode.
2. Press the **[BND]** button. Each time you press the **[BND]** button, the display changes in the following order:
[M1] → [M2] → [M3] → [M1]...
3. Press one of the **[DIRECT]** buttons to recall a preset programme.

Note:

- Press and hold the **[DIRECT]** button for 2 seconds or longer to store the programme currently being received. (Manual memory)

AF function

The AF function switches to a different frequency on the same network in order to maintain optimum reception.

- * The factory default setting is "ON"
- * If the reception of the current broadcast station deteriorates, "SEARCH" appears in the display and the radio searches for the same programme on another frequency.
- * For details on "AF function", refer to the section "RDS operation" of each owner's manual.

● **Switching OFF the AF function**

● **Switching ON the AF function**

● **AF function between RDS and DAB**

When the same programme is broadcast by both RDS and DAB, and this function is ON, the main unit switches to receiving the broadcast with the better reception automatically.

TA (Traffic Announcement)

In the TA standby mode, when a traffic announcement broadcast starts, the traffic announcement broadcast is received as top priority regardless of the function mode. Traffic programme (TP) automatic tuning is also possible.

- * This function can only be used when "TP" is lit in the display. When "TP" is lit, this means that the DAB or RDS broadcast station being received has traffic announcement programmes.
- * For details on "TA", refer to the section "RDS operation" of each owner's manual.

● **Setting the TA standby mode**

● **Cancelling the TA standby mode**

● **Searching for a TP station**

Notes:

- If a TP station is not received, the main unit stops the search operation.
- "TP" may be lit in the display when a TP broadcast is transmitted from an RDS station. In this case, press the [TA] button to perform TP seek tuning. Press the [TA] button again to return to the previous mode.

INFO (Announcement)

In the INFO standby mode, when the selected announcement programme starts, the main unit switches to the selected announcement programme automatically.

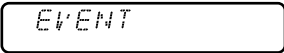

● **Setting the INFO standby mode**

If you press and hold the [TA] button for 1 second or longer, "INFO" lights in the display and the main unit is set into the INFO standby mode until the selected announcement is broadcast. When the selected announcement broadcast starts, the announcement item appears in the display. If you press and hold the [TA] button for 1 second or longer while the selected announcement broadcast is being received, the selected announcement broadcast reception is cancelled and the main unit goes into the INFO standby mode.

● **Cancelling INFO standby mode**

To cancel the INFO standby mode, press and hold the [TA] button for 1 second or longer.

● **Information select**

This is a function for selecting INFORMATION ON or OFF in the Information interrupt mode. You can set ON up to 6 information items.

You can select any of the 6 items below:

INFORMATION item	
ENGLISH	Contents
TRAVEL	Transport flash
WARNING	Warning / Service
NEWS	News flash
WEATHER	Area weather flash
EVENT	Event announcement
SPECIAL	Special event

1. Perform the following operation depending on the connected model.
Press and hold the [T] button for 1 second or longer.
2. Press the [◀] or [▶] button to select "INFO SEL", then press the [▶▶] button to enter "INFO SEL" mode.
3. Press the [◀] or [▶] button to select an information item. You can select any of 6 items:
TRAVEL → WARNING → NEWS → WEATHER → EVENT → SPECIAL → TRAVEL → ...
4. Perform the following operation depending on the connected model.
Turn the [ROTARY] knob clockwise or counterclockwise to set the information item for ON or OFF.
5. Press the [▶▶] button to store the setting.
6. Press the [T] button to return to the previous display.

PTY

This function enables you to listen to the selected programme type, irrespective of the function mode.

- * One common PTY can be selected for DAB or RDS.
- * Of DAB PTY and RDS PTY, the PTY which is received earlier takes priority over the other.
- * PTY broadcasts are not yet available in all countries.
- * In the INFO standby mode, INFO stations have priority over PTY stations.
- * In the TA standby mode, TP stations have priority over PTY stations.
- * For details on “PTY”, refer to the section “**RDS operation**” of each owner’s manual.

● **Setting the PTY standby mode**● **Cancelling the PTY standby mode**● **Cancelling a PTY interrupt broadcast**● **Selecting PTY**● **PTY seek**● **PTY preset memory****Emergency broadcast**

When an emergency broadcast is received, all the function mode operations are stopped.

“**ALARM**” appears in the display and the emergency broadcast can be heard.

- * For details on “**Emergency broadcast**”, refer to the section “**RDS operation**” of each owner’s manual.

● **Cancelling an emergency broadcast****Switching the PTY and INFO display language**

You can select one of 4 languages (English, German, Swedish or French) for the PTY and INFO shown in the display.

- * The factory default setting is “**ENGLISH**”.
- * For details on “**Switching the PTY display language**”, refer to the section “**RDS operation**” of each owner’s manual.

Volume setting of TA, INFO, emergency broadcast (ALARM) and PTY

The volume for TA, INFO, ALARM and PTY interrupts can be set during TA, INFO, ALARM and PTY interrupt. Perform the following operation depending on the connected model.

- * The factory default setting is “**15**”.

During a TA, INFO, ALARM or PTY interrupt, turn the [**ROTARY**] knob clockwise or counterclockwise to set the volume to a desired level (0 to 33).

- * When the TA, INFO, ALARM or PTY interrupt ends, the volume returns to the level it had before the interrupt.

8. IN CASE OF DIFFICULTY

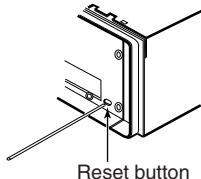
	Problem	Cause	Measure
General	Power does not turn on. (No sound is produced.)	Fuse is blown.	Replace with a fuse of the same amperage. If the fuse blows again, consult your store of purchase.
		Incorrect wiring.	Consult your store of purchase.
	No sound output when operating the unit with amplifiers or power antenna attached.	Power antenna lead is shorted to ground or excessive current is required for remote-on the amplifiers or power antenna.	<ol style="list-style-type: none"> 1. Turn the unit off. 2. Remove all wires attached to the power antenna lead. Check each wire for a possible short to ground using an ohm meter. 3. Turn the unit back on. 4. Reconnect each amplifier remote wire to the power antenna lead one by one. If the amplifiers turn off before all wires are attached, use an external relay to provide remote-on voltage (excessive current required).
	Nothing happens when buttons are pressed. Display is not accurate.	The microprocessor has malfunctioned due to noise, etc.	Turn off the power, then press the [RELEASE] button and remove the DCP. Press the reset button for about 2 seconds with a thin rod. 
DCP or main unit connectors are dirty.		Wipe the dirt off with a soft cloth moistened with cleaning alcohol.	
CD	Compact disc cannot be loaded.	Another compact disc is already loaded.	Eject the compact disc before loading the new one.
	Sound skips or is noisy.	Compact disc is dirty.	Clean the compact disc with a soft cloth.
		Compact disc is heavily scratched or warped.	Replace with a compact disc with no scratches.
Sound is bad directly after power is turned on.	Water droplets may form on the internal lens when the car is parked in a humid place.	Let dry for about 1 hour with the power on.	

9. ERROR DISPLAYS

If an error occurs, one of the following displays is displayed.
Take the measures described below to eliminate the problem.

	Error Display	Cause	Measure
CD	ERROR 2	A CD is caught inside the CD deck and is not ejected.	This is a failure of CD deck's mechanism and consult your store of purchase.
	ERROR 3	A CD cannot be played due to scratches, etc.	Replace with a non-scratched, non-warped-disc.
	ERROR 6	A CD is loaded upside-down inside the CD deck and does not play.	Eject the disc then reload it properly.
CD changer	ERROR 2	A CD inside the CD changer is not loaded.	This is a failure of CD changer's mechanism and consult your store of purchase.
	ERROR 3	A CD inside the CD changer cannot be played due to scratches, etc.	Replace with a non-scratched, non-warped disc.
	ERROR 6	A CD inside the CD changer cannot be played because it is loaded upside-down.	Eject the disc then reload it properly.
DVD changer	ERROR 2	A DISC inside the DVD changer cannot be played.	This is a failure of DVD mechanism and consult your store of purchase.
	ERROR 3	A DISC cannot be played due to scratches, etc.	Retry or replace with a non-scratched, non-warped-disc.
	ERROR 6	A DISC inside the DVD changer cannot be played because it is loaded upside-down.	Eject the disc then reload it properly
	ERROR P	Parental level error	Set the correct Parental level.
	ERROR R	Region code error	Eject the disc and replace correct region code disc.
General	AMP GRD	The speaker protection circuit is operating. During this operation, if any volume operation is performed, the display shows "AMP GRD".	<ol style="list-style-type: none"> 1. Turn down sound volume. Function can also be restored by turning the power off and on again. (Speaker volume is reduced automatically when the speaker protection circuit operates). 2. If the sound is muted again, consult our service department.

If an error display other than the ones described above appears, press the reset button. If the problem persists, turn off the power and consult your store of purchase.

10. SPECIFICATIONS

Radio section

Tuning System: PLL synthesizer tuner

Receiving Frequencies:

FM : 87.5 to 108 MHz (0.05 MHz steps)

MW : 531 to 1602 kHz (9 kHz steps)

LW : 153 to 279 kHz (3 kHz steps)

CD player section

System: Compact disc digital audio system

Frequency Response: 10 Hz to 20 kHz (± 1 dB)

Signal to Noise Ratio: 100 dB (1 kHz)

Dynamic Range: 95 dB (1 kHz)

Distortion: 0.01%

General

Output Power: 4×27 W (DIN 45324, +B=14.4V)

Power Supply Voltage:

14.4 V DC (10.8 to 15.6 V allowable),
negative ground

Power Consumption: Less than 15 A

Speaker Impedance: 4Ω (4 to 8Ω allowable)

Auto Antenna Rated Current: 500 mA or less

Weight:

Main unit: 1.2 kg

Dimensions:

Main unit :

178 (W) \times 50 (H) \times 155 (D) mm

Note:

- *Specifications and design are subject to change without notice for further improvement.*