



Aspen, Chamonix & Tahoe Decorative Gas Basket Fires

With upgradeable control valve

Instructions for Use, Installation and Servicing

For use in GB, IE (Great Britain and Eire)

This appliance has been certified for use in countries other than those stated. To install this appliance in these countries, it is essential to obtain the translated instructions and in some cases the appliance will require modification. Contact Gazco for further information.

IMPORTANT

Do not attempt to burn rubbish in this appliance. This appliance must only be operated with the glass door secured firmly in position. The front casing of this appliance will become hot whilst in operation, it is therefore recommended that a suitable guard should be used for the protection of young children, the elderly or infirm.

**Please read these Instructions carefully before installation or use.
Keep them in a safe place for future reference and when servicing the fire.**

The commissioning sheet on page 3 MUST be completed by the Installer.

Covering the following models

(P)8135**UC (P)8143**UC (P)8119**UC (P)8127**UC

(P)8136**UC (P)8144**UC (P)8120**UC (P)8128**UC

Please Note -** Will be replaced with the appropriate fuel effect suffix as follows:

MC - Coal effect PB - Pebble effect GL - Glass granules L - Log effect DW - Driftwood effect

CONTENTS

	PAGE
APPLIANCE COMMISIONING CHECKLIST	3
USER INSTRUCTIONS	4
INSTALLATION INSTRUCTIONS	12
Technical Specifications	12
Site Requirements	13
Installation	15
Commisioning	22
SERVICING INSTRUCTIONS	23
Servicing Requirements	23
Fault Finding	24
How to replace parts	26
Basic spare parts list	30
Service Record	31

APPLIANCE COMMISSIONING CHECKLIST

IMPORTANT NOTICE

Explain the operation of the appliance to the end user, hand the completed instructions to them for safe keeping, as the information will be required when making any guaranteed claims.

FLUE CHECK	PASS	FAIL	
1. Flue is correct for appliance			
2. Flue flow test			
3. Spillage test			
GAS CHECK			
1. Gas soundness & let by test			
2. Standing pressure test	mb		
3. Appliance working pressure (on High Setting) NB All other gas appliances must be operating on full	mb		
4. Gas rate	m ³ /h		
5. Does ventilation meet appliance requirements			
6. Have controls been upgraded (Upgradeable models only)	8455 Standard	YES	NO
	8456 Programmable Thermostatic and Timer	YES	NO

DEALER AND INSTALLER INFORMATION

Dealer.....

Installation Company.....

Contact No.

Engineer

Date of Purchase.....

Contact No.

Model No.

Corgi Reg No.

Serial No.

Date of Installation.....

Gas Type.....

This product is guaranteed for 2 years from the date of installation, as set out in the terms and conditions of sale between Gazco and your local Gazco dealer. **This guarantee will be invalid, to the extent permitted by law, if the above Appliance commissioning Checklist is fully completed by the installer and available for inspection by a Gazco engineer.** The guarantee will only be valid during the second year, to the extent permitted by law, if the annual service recommended in the Instructions for Use has been completed by a Corgi registered engineer, and a copy of the service visit report is available for inspection by a Gazco engineer.

USER INSTRUCTIONS

1. GENERAL

- 1.1 Installation and servicing must only be carried out by a competent person.
- 1.2 In all correspondence, please quote the appliance type and serial number, which can be found on the databadge located on a chain beneath the control valve.
- 1.3 Ensure that curtains are not positioned above the fire, and that there is a 300mm minimum clearance between the sides of the fire and any curtains.
- 1.4 This product is guaranteed for 2 years from the date of installation, as set out in the terms and conditions of sale between Gazco and your local Gazco dealer. Please consult with your local Gazco dealer if you have any questions. In all correspondence always quote the Model Number and Serial Number.

2. LIGHTING THE APPLIANCE

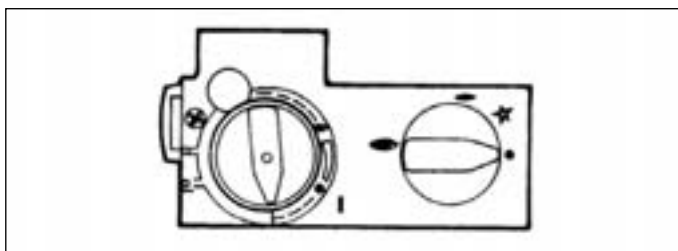

- 2.1 Locate the control valve on the appliance. There are two control knobs on the valve, the right hand knob controls the pilot ignition and the left hand knob controls the main burner.
- 2.2 If your appliance has already been upgraded to battery remote control, please refer to the instructions provided with the upgrade to operate the remote control. The following instructions will work for either situation.
- 2.3 Ensure that the left-hand control knob is pointing to off (●).
- 2.4 Ensure that the right hand control knob is pointing to off (●).
- 2.5 Press in the right hand control knob and rotate it anti-clockwise until a click is heard (keep pressing in) and the knob is pointing to pilot (☛). The pilot should now light. If the pilot has not lit, repeat the procedure until it does.
- 2.6 Keep the control knob pressed for 10 seconds and then release it, the pilot should stay alight. If the pilot goes out, repeat the procedures until it does.
- 2.7 If the pilot will not light after repeated attempts, contact the retailer or installer from whom the appliance was purchased.
- 2.8 Turn the right hand control to point to main burner (☛). The appliance can now be controlled using the left hand control knob.
- 2.9 Turn the left hand control knob to point to low fire (☛), the main burner will light on low. The burner can now be controlled between low and high settings. Turn the control

knob anticlockwise to increase the flame height and clockwise to decrease the flame height.

THE YELLOW FLAMES WILL APPEAR WHEN THE FIRE HAS GAINED SUFFICIENT HEAT - TYPICALLY 10 TO 20 MINUTES.

3. TURNING THE APPLIANCE OFF

- 3.1 To turn the fire off, locate the control valve, turn the left-hand control knob until it points to off (●). The main burner will go out leaving the pilot burning.
- 3.2 To turn the pilot off, locate the control valve, turn the right hand control knob until it points to off (●), the pilot will go out.
- 3.3 **IF THE FIRE IS EXTINGUISHED OR GOES OUT IN USE, WAIT 3 MINUTES BEFORE ATTEMPTING TO RE-LIGHT.**
- 3.4 After the fire has been turned off, the gas left in the burner will continue to burn, causing a crackling or popping noise. This is quite normal and will last up to one minute.

4. LIGHTING THE FIRE WITH A MATCH

If the pilot does not ignite as described in Section 2, it may be lit with a match.

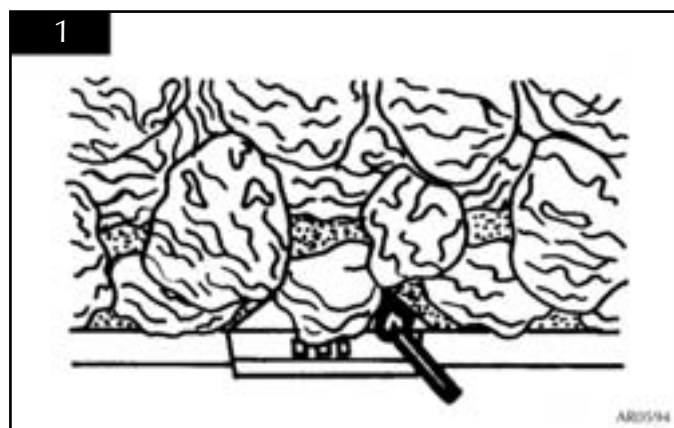

- 4.1 Press in the right hand control knob and rotate it anti-clockwise until a click is heard (keep pressing in) and the knob is pointing to pilot (☛), apply a lighted match to the pilot hood, see diagram 1.
- 4.2 When the pilot is alight, extinguish the match and continue to depress for 5 to 10 seconds.
- 4.3 The fire may now be controlled as previously described.

USER INSTRUCTIONS

5. UPGRADING YOUR FIRE

- 5.1 Your fire is fitted with a control valve that can be easily upgraded to battery powered remote control. This upgrade can be fitted by anyone capable of simple DIY jobs and requires no special training. This upgrade can be obtained through your local Gazco stockist.
- 5.2 **STANDARD REMOTE CONTROL** This remote control can control the fire after the pilot has been lit. It can turn the main burner on and regulate it from low through to high and back again. It can turn the main burner off leaving the pilot burning GAZCO PART NUMBER 8455.
- 5.3 The remote control receiver box is supplied with a 0.8 metre lead, which attaches to the control valve. The receiver must be located in a position that will receive a signal from the handset and may be attached using the adhesive pads supplied in the instruction kit. The receiver must not be located on any surface which may become hot when the fire is in use.
- 5.4 **IMPORTANT** - there is a thermostatic version of the upgrade but this is **NOT SUITABLE** for open flame fires .

6. CLEANING THE FIRE

- 6.1 Cleaning should only be carried out when the fire is turned off and cold.
NOTE: Do not use a vacuum cleaner.
- 6.2 Cleaning is necessary when there is any chimney debris visible on the fuel effect, or if there is a soot build up in the fire. Minor soot deposits can be ignored.
- 6.3 Remove the fuel effect carefully onto a sheet of paper.
- 6.4 Clean the fuel effect using a soft brush taking great care not to damage them.
- 6.5 Foreign objects or debris which have been thrown, or have fallen onto the fire should be removed when the fire is cold, by hand.
- 6.6 Replace the ceramic components by referring to section 7.

7. ARRANGEMENT OF FUEL BED COMPONENTS

NOTE: CERAMIC PARTS ARE FRAGILE.

7.1 General

- 7.1.1 Your fire will be supplied either with a ceramic Coal, Log, Pebble or Driftwood effect This will have been specified at the time of ordering. With pebble fires follow coal layouts. With driftwood fires follow log layouts.
- 7.1.2 Positioning of ceramic parts is important, not only for the flame effect, but also for optimum performance of the appliance.
- 7.1.3 It is important that the ceramic fuel effect pieces are placed

so that there are gaps around each for the flames to pass through.

- 7.1.4 Ceramic components must only touch each other at single points, avoid whole sides touching.
- 7.1.5 Do not use any more ceramic components than those shown, extra parts supplied are spares and should be kept for future use.
- 7.1.6 The ceramic components should last about 2 years in normal use at which time it is recommended to replace them. Replacement parts can be bought from any stockist who supplies GAZCO fires, always state the model number found on the databadge.
- 7.1.7 The parts are supplied in various quantities depending on the size of the fire delivered. Check your coals, pebbles, driftwood and logs. If any are damaged, contact your Gazco stockist for replacements. Always ask for genuine Gazco parts.
- 7.1.8 Depending on the fuel effect that you have been supplied with, follow the correct section.

7.2 Glass Granules

- 7.2.1 If you have chosen the glass granular fuel effect, open the bag of glass granule and fill the fire to the top ensuring the granules finish level with the top of the tray.
- 7.2.2 Firmly pat the granules down to ensure that there are no voids below the surface. It is important to ensure that the granules fill all the gaps around the burner, and that the granules finish level with the top of the tray.

7.3 Firebeads

- 7.3.1 If you have chosen any other of the fuel effects (coal, pebble or log), it will be necessary to fill the tray with firebeads.
- 7.3.2 You will find 2 sizes of firebeads, large and small. Using the large beads, fill the fire to within 10mm of the top, level the beads and pat down. See diagram 2.

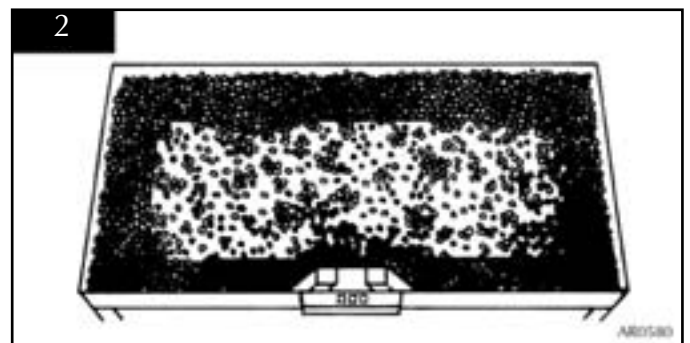

USER INSTRUCTIONS

7.3.3 Using the small beads, fill the fire to the top.
See diagram 3.

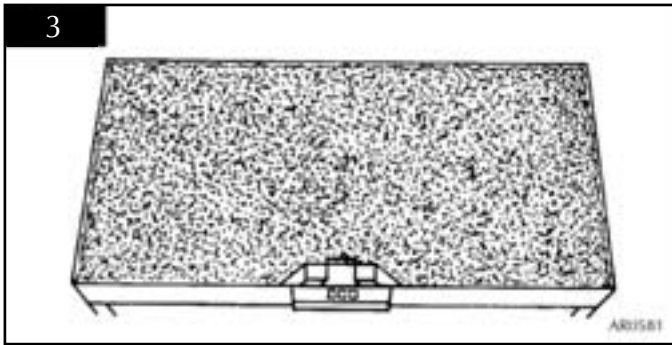

7.3.4 Smooth out the fire beads, it is important to ensure that the fire is completely filled, level to the top.

NOTE: if your fire needs more beads, then there should be some left over from the original installation, if not then more must be ordered from your Gazco stockist. Do not use any other type of material as this may seriously damage your fire and could be dangerous.

7.3.5 Firmly pat the beads down to ensure that there are no voids left below the surface.

7.3.6 Ensure that no beads have fallen into the pilot area.

7.3.7 Ensure that the pilot shield is fitted correctly and that it fits tightly onto the edge of the tray. See diagram 4.

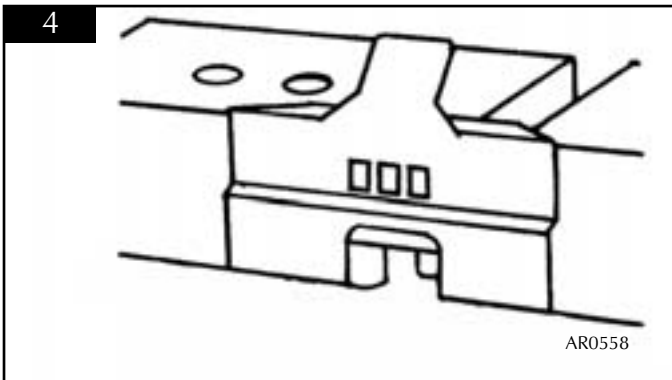

7.4 Coal & Pebble Layout - Small Aspen & Chamonix

7.4.1 Place 8 large square blocks in a solid mass in the centre of the burner tray as shown, ensure they fit tightly together. See diagram 5.

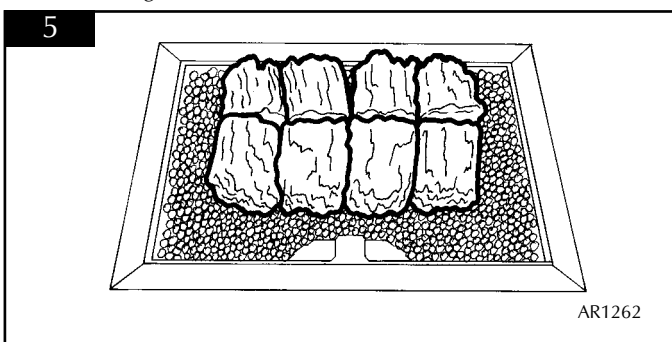

7.4.2 Place 14 small coals or pebbles around the edge of the tray as shown, ensure that there are gaps between each coal or pebble. Place one on top of the pilot shield. See diagram 6.

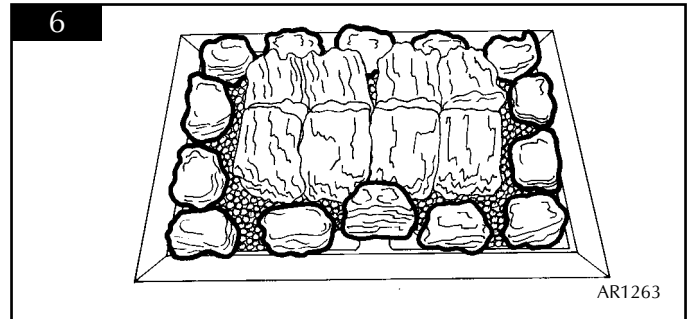

7.4.3 Starting at the front, place 14 alternating large and small coals or pebbles around the perimeter of the fire, they should sit on the bottom row of small coals or pebbles and rest against the inner mass of square blocks. See diagram 7.

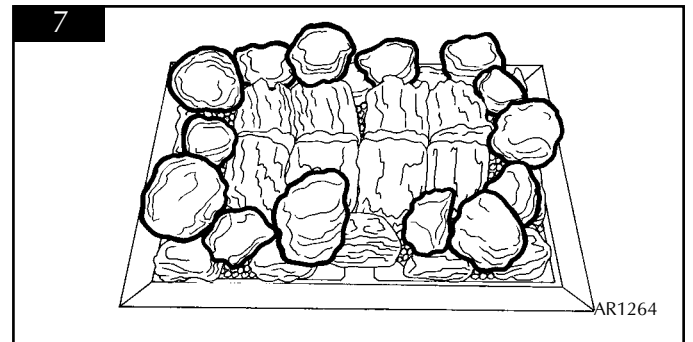

7.4.4 Place the remaining 6 large coals or pebbles on top of the square blocks, ensure that there are gaps between each coal or pebble. See diagram 8.

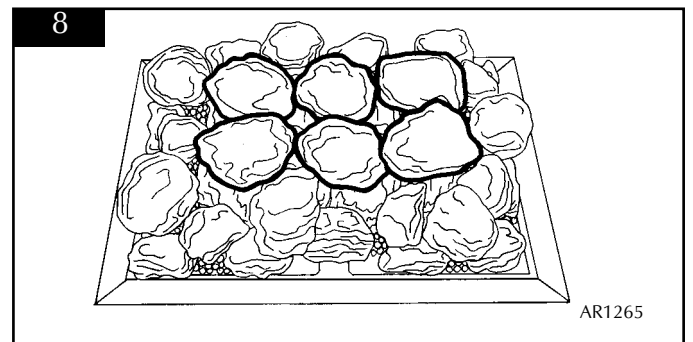

USER INSTRUCTIONS

7.5 Coal & Pebble Layout - Medium Chamonix, Large Aspen & Chamonix

7.5.1 Place 15 large square blocks in a solid mass in the centre of the burner tray as shown, ensure they fit tightly together. See diagram 9.

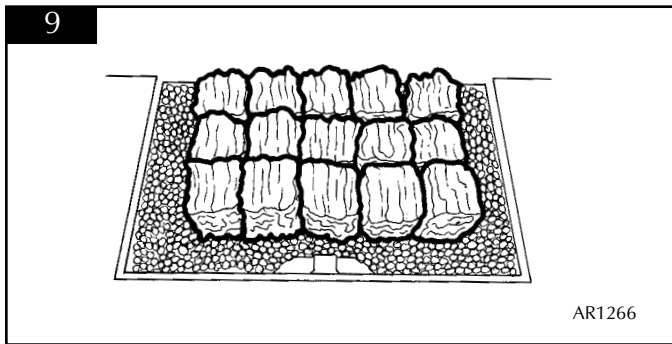

7.5.2 Place 18 small coals or pebbles around the edge of the tray as shown, ensure that there are gaps between each coal or pebble. Place one on top of the pilot shield. See diagram 10.

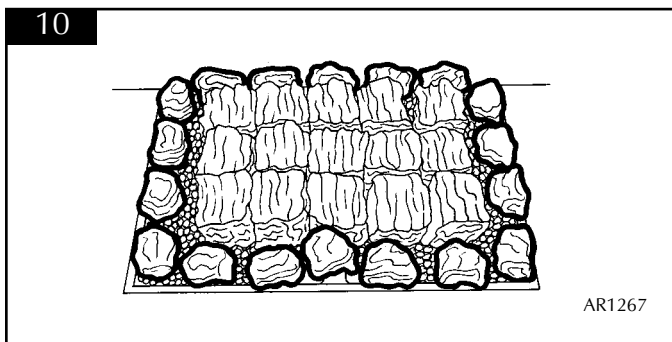

7.5.3 Starting at the front, place 18 alternating large and small coals or pebbles around the perimeter of the fire, they should sit on the bottom row of small coals or pebbles and rest against the inner mass of square blocks. See diagram 11.

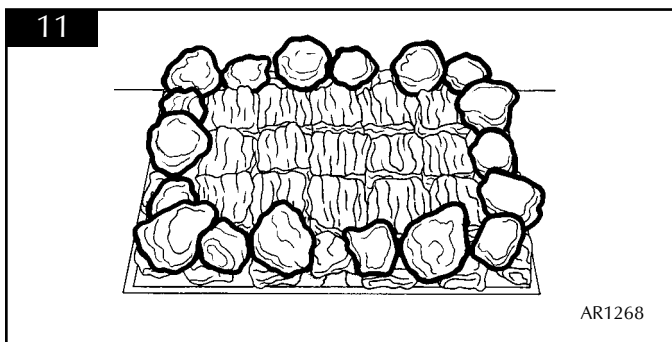

7.5.4 Place the remaining 11 large coals or pebbles on top of the square blocks, ensure that there are gaps between each coal or pebble. See diagram 12.

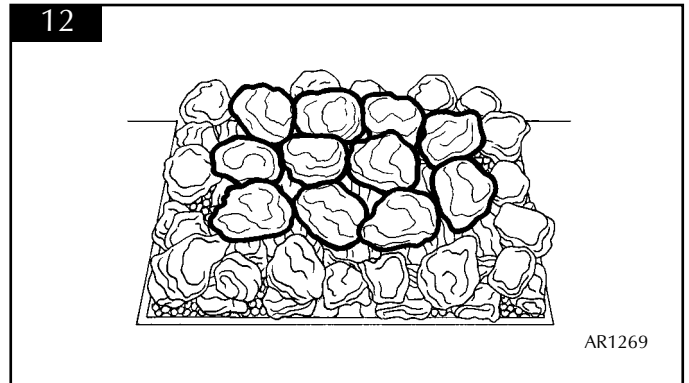

7.6 Coal & Pebble Layout - Tahoe

7.6.1 Place 10 small coals or pebbles around the edge of the tray as shown, ensure that there are gaps between each coal or pebble. See diagram 13.

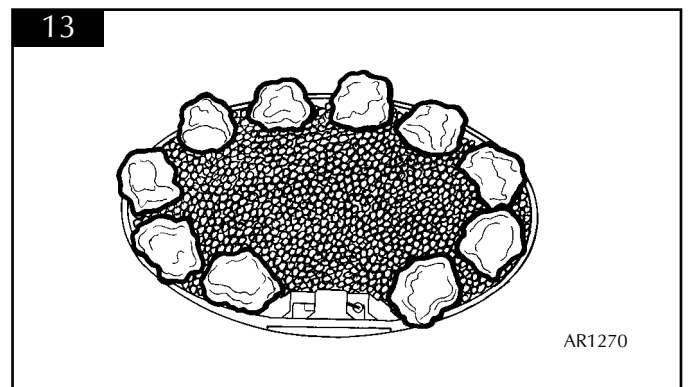

7.6.2 Place 6 large square blocks in a solid mass in the centre of the burner tray as shown, ensure they fit tightly together. See diagram 14.

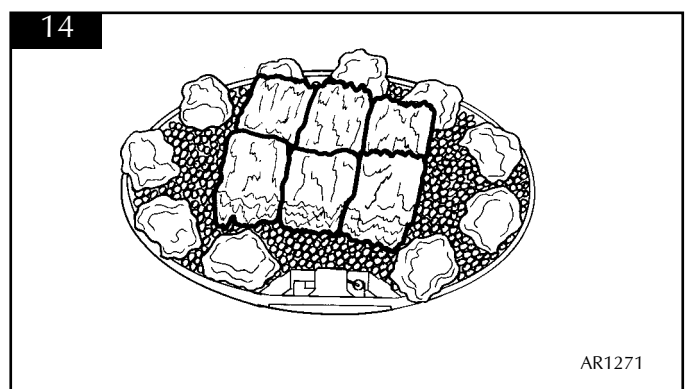

USER INSTRUCTIONS

7.6.3 Place one large coal or pebble on top of the pilot shield, then place 10 alternating large and small coals or pebbles around the perimeter of the fire. They should sit on the bottom row of small coals or pebbles and rest against the inner mass of square blocks. Place one small coal or pebble on top of the centre of the square blocks. See diagram 15.

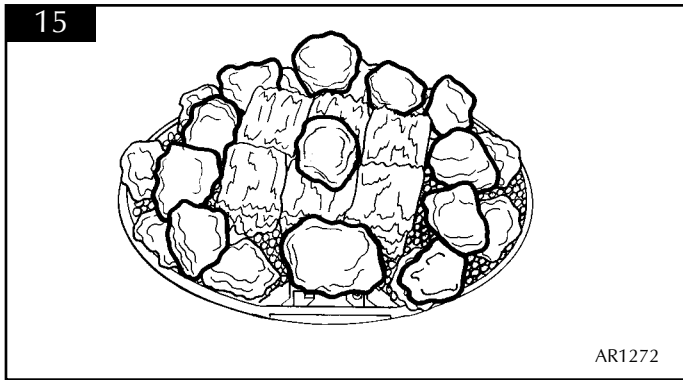

7.6.4 Place the remaining 4 large coals or pebbles on top of the square blocks, ensure that they lean against the central small coal or pebble and that there are gaps between each coal or pebble. See diagram 16.

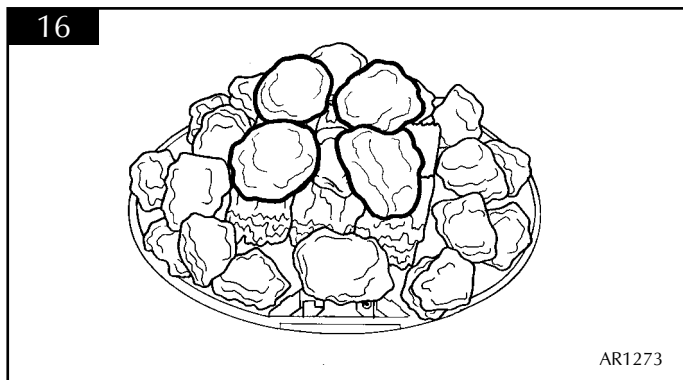

7.7 Log & Driftwood Layout – Small Aspen & Chamonix

It may be necessary to make small changes to the log positioning in order to achieve the most pleasing flame effect but the following guidelines should be followed.

7.7.1 Refer to the log identification chart and identify the numbers corresponding to the logs that have been supplied. See diagram 17

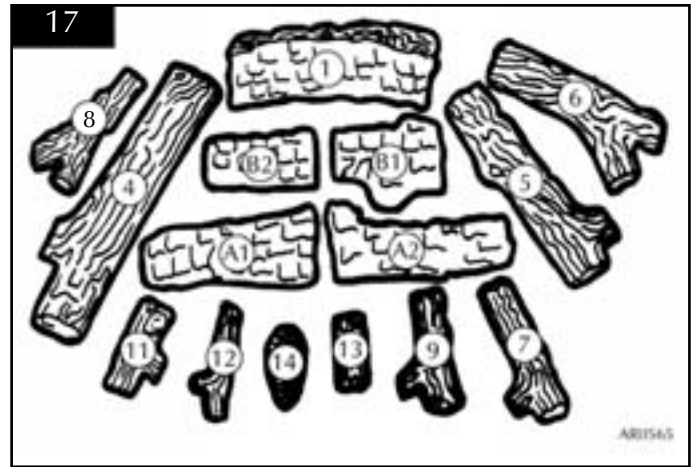

7.7.2 Place the two logs (No.13) on top of the beads as shown. See diagram 18.

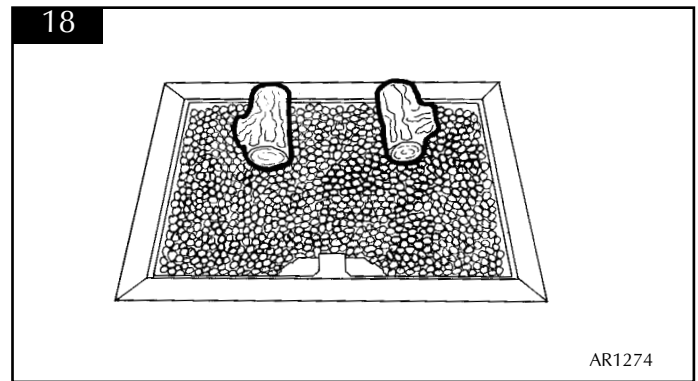

7.7.3 Place the large log (No. 1) so that it sits on top of the previous two logs. Place the burnt effect log (No. B1) in the centre of the tray as shown. See diagram 19.

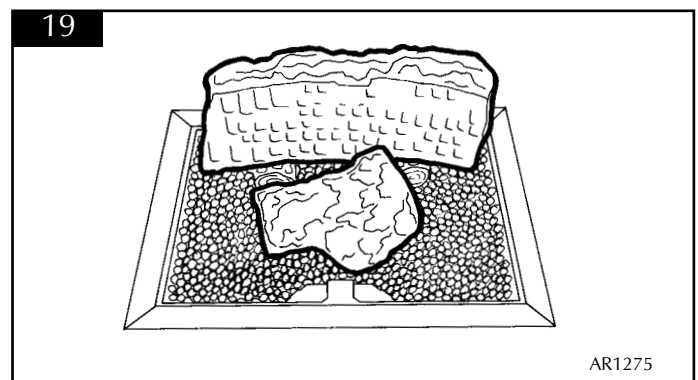

USER INSTRUCTIONS

7.7.4 Place log (No. 7) along the LH side of the tray, log (No. 9) along the RH side of the tray and place logs (No. 8 and 11) along the front of the tray as shown. Place the cone (No. 14) on the LH side of the burnt log. See diagram 20.

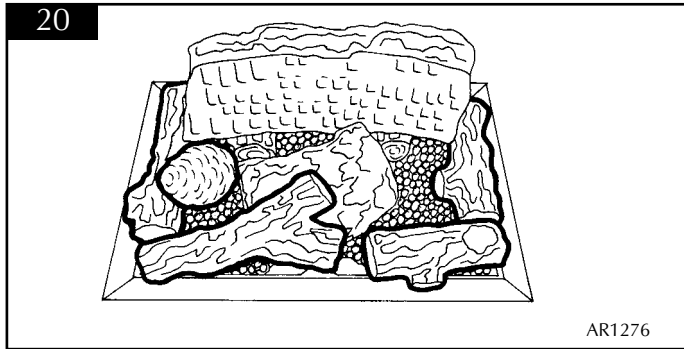

7.7.5 Place the large log (No. 6) so that it rests on top of the rear and front logs to the LH side, Place log (No. 7) on the RH side and log (No. 8) so that it bridges the centre gap as shown. See diagram 21.

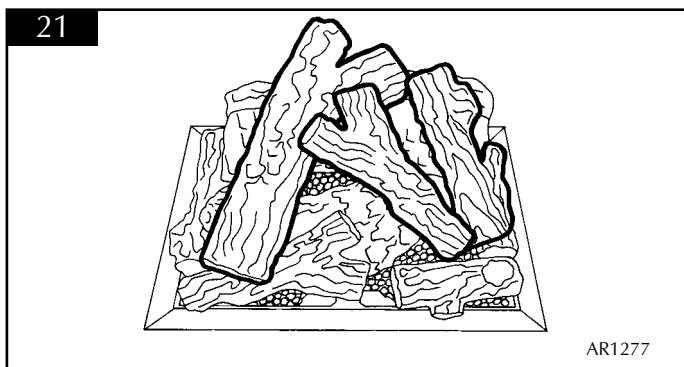

7.8 Log & Driftwood Layout – Medium Chamonix, Large Aspen & Chamonix

It may be necessary to make small changes to the log positioning in order to achieve the most pleasing flame effect but the following guidelines should be followed.

7.8.1 Refer to the log identification chart and identify the numbers corresponding to the logs that have been supplied. See diagram 22.

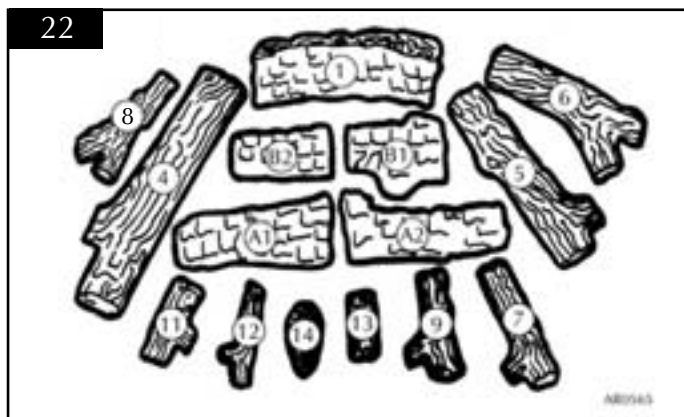

7.8.2 Place the two logs (No.13) on top of the beads as shown. See diagram 23.

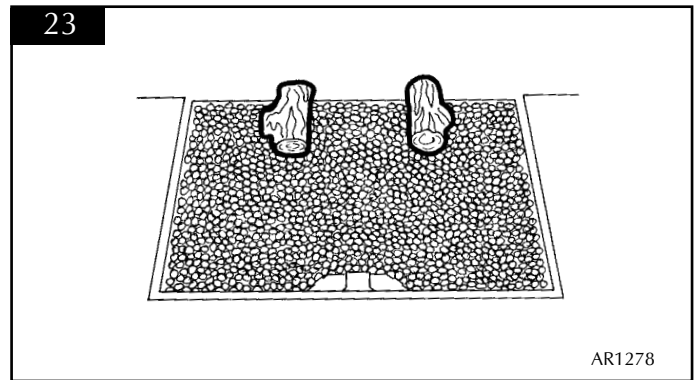

7.8.3 Place the large log (No. 1) so that it sits on top of the previous two logs. Place the burnt effect log (No. A1) in the centre of the tray as shown. Place one log (No. 7) along each side of the tray, another log (No. 7) along the front LH side and a log (No. 8) along the front RH side of the tray. See diagram 24.

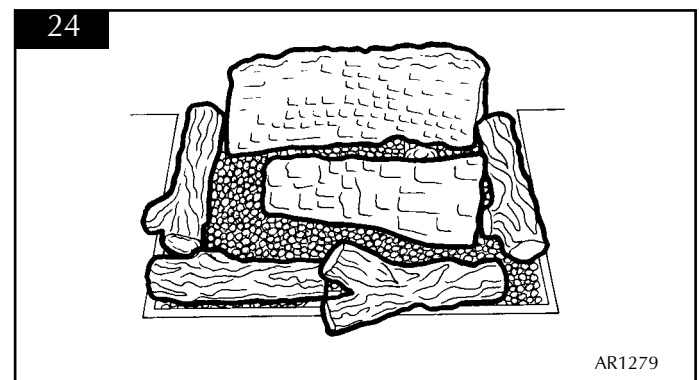

7.8.4 Place two cones (No. 14), one in the RH front corner and the other at the LH side of the burnt log. See diagram 25.

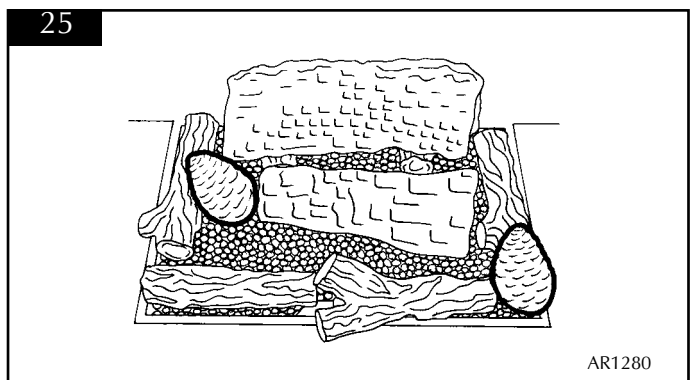

USER INSTRUCTIONS

7.8.5 Place one large log (No. 6) so that it rests on top of the rear and front logs to the LH side. Place the other large log (No. 6) so that it rests on top of the rear and front logs on the RH side and log (No. 8) so that it bridges the centre gap as shown. See diagram 26.

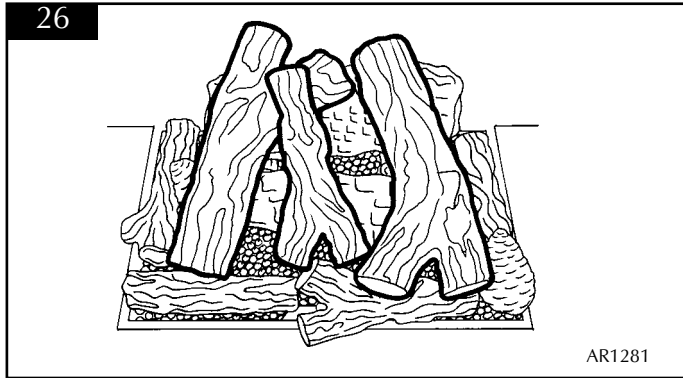

7.9 Log & Driftwood Layout – Tahoe

It may be necessary to make small changes to the log positioning in order to achieve the most pleasing flame effect but the following guidelines should be followed.

7.9.1 Refer to the log identification chart and identify the numbers corresponding to the logs that have been supplied. See diagram 27.



7.9.2 Place a cone (No. 14) in the centre at the rear edge of the tray and place one log (No. 13) at each side of the cone. Place one log (No. 11) along the front of the tray at each side of the pilot. See diagram 28.

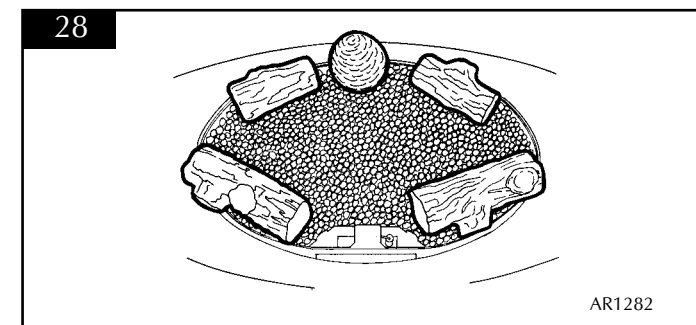

7.9.3 Place the burnt effect log (No. B1) in the centre of the tray. See diagram 29.

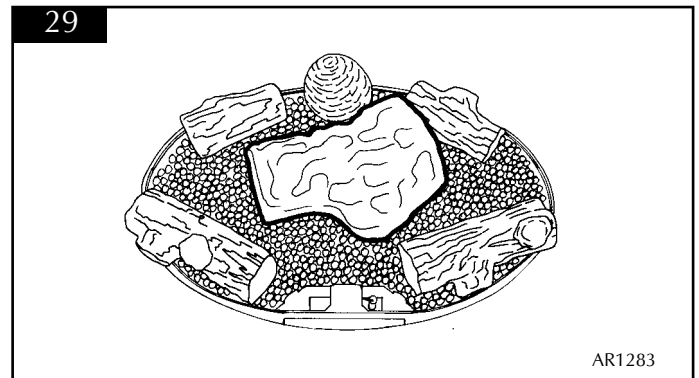

7.9.4 Place one log (No. 8) in the centre so that it rests on the rear cone and the pilot shield. See diagram 30.

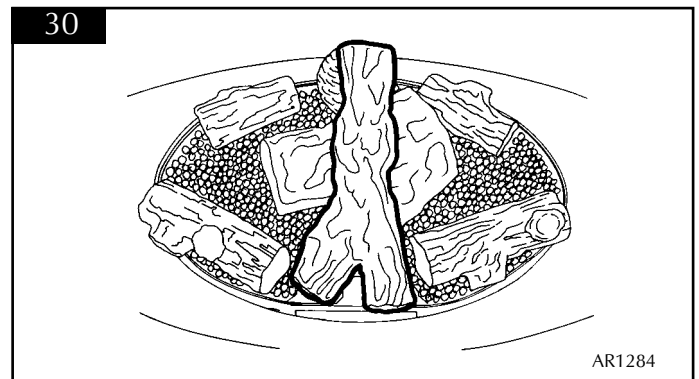

7.9.5 Place one log (No. 11) so that it rests on the LH front log and the burnt log. Place another log (No. 7) so that it rests on the RH front log and the burnt log. See diagram 31.

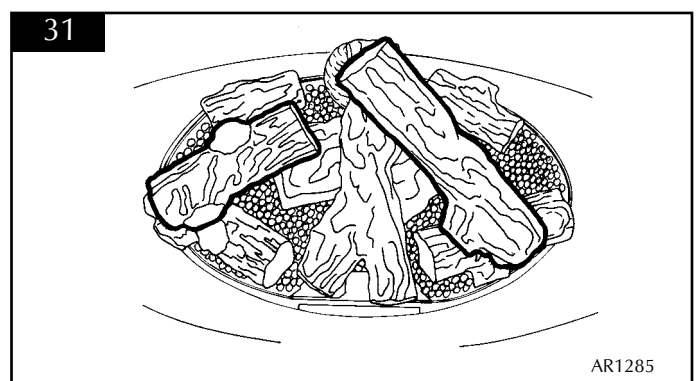

USER INSTRUCTIONS

- 7.9.6 Place the two thin logs (No. 12), one at each side sitting on the tray and resting against the previously positioned logs. Place one log (No. 9) at the LH rear resting on the base log, and one log (No. 8) at the RH rear. See diagram 32.

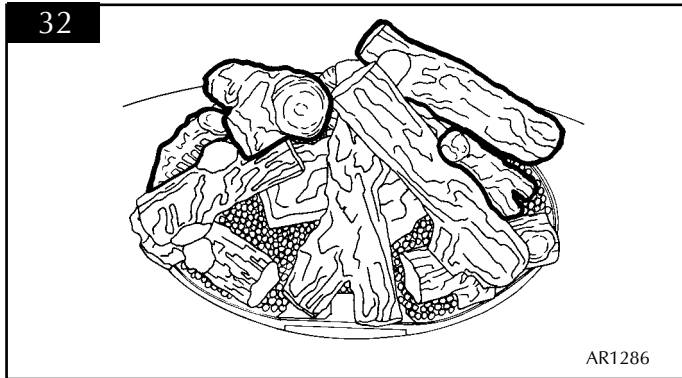

8. OXYGEN DEPLETION SENSOR

- 8.1 The appliance is fitted with an oxygen sensitive pilot system that will act to cut off the gas supply to the fire should the oxygen in the room fall below its normal level. If the fire is turned off by this device, it usually indicates that there is a problem with the flue system, and this should be inspected by a qualified engineer.

Do not attempt to use the fire until an engineer says it is safe to do so.

This device is not a substitute for an independently mounted carbon monoxide detector.

9. FLAME FAILURE DEVICE

- 9.1 This is a safety feature incorporated in all GAZCO fires which automatically switches off the gas supply if the pilot goes out and fails to heat the thermocouple.

10. RUNNING IN

- 10.1 The surface coating on the fuel effect used in your GAZCO fire will "burn off" during the first few hours of use producing a harmless and temporary odour. This will disappear after a short period of use. If the odour persists, ask your installer for advice.

11. SERVICING

- 11.1 The fire must be serviced every 12 months by a qualified Gas Engineer. In all correspondence always quote the appliance type and the serial number which may be found on the databadge, located on a chain underneath the control valve.

INSTALLATION INSTRUCTIONS

TECHNICAL SPECIFICATION

MODEL	GAS TYPE	GAS CATEGORY	INLET PRESSURE (mb)	AERATION SIZE	INJECTION SIZE	BURNER PRESSURE(mb) ^(pre-set)		INPUT (kW)		GAS FLOW RATE (m ³ /hr)	
						HIGH	LOW	HIGH	LOW	HIGH	LOW
TAHOE	NATURAL	G20	20 mb	7.5mm	1100	9.0	2.6	12	6	1.11	0.56
	BUTANE	G30	29 mb	3 * 15mm	400	16.3	4.6	12	6	0.34	0.17
	PROPANE	G31	37 mb	3 * 15mm	400	21.1	6.0	12	6	0.43	0.22
SMALL ASPEN & CHAMONIX	NATURAL	G20	20 mb	7.5 mm	1600	5.4	1.7	13	6.5	1.21	0.61
	BUTANE	G30	29 mb	3 * 15mm	400	20.0	5.6	13	6.5	0.36	0.18
	PROPANE	G31	37 mb	3 * 15mm	400	25.3	7.0	13	6.5	0.48	0.24
MEDIUM & LARGE CHAMONIX & LARGE ASPEN	NATURAL	G20	20 mb	7.5mm	1600	8.3	2.6	16	8	1.51	0.76
	BUTANE	G30	29 mb	3 * 15mm	600	15.7	4.3	16	8	0.45	0.23
	PROPANE	G31	37 mb	3 * 15mm	600	20.5	5.6	16	8	0.58	0.29

INSTALLATION INSTRUCTIONS

SITE REQUIREMENTS

1. FLUE AND CHIMNEY REQUIREMENTS

- 1.1 The chimney or flue system must comply with the rules in force.
- 1.2 Fireplace opening up to 450mm (18") wide by 600mm (24") high will usually work with a 175mm (7") diameter flue. Larger openings will require bigger flues. See diagram 1 as a guide.

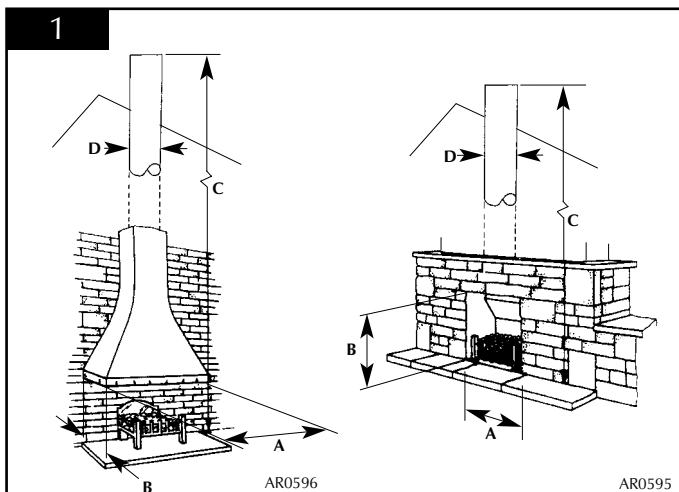

mm A	mm B	cm ² A x B	C				
			3.0m	4.5m	6.0m	9.0m	15.0m
350	550	1925cm ²	175	175	175	175	175
400	550	2200cm ²	175	175	175	175	175
460	460	2116cm ²	175	175	175	175	175
460	550	2530cm ²	200	175	175	175	175
460	610	2806cm ²	200	200	175	175	175
610	460	2806cm ²	200	200	175	175	175
610	610	3721cm ²	250	225	200	200	175
610	760	4636cm ²	300	250	250	225	200
760	460	3496cm ²	225	225	200	200	175
760	610	4636cm ²	250	250	250	225	200
760	760	5776cm ²	300	300	250	250	225
760	910	6916cm ²	350	300	300	250	250
910	460	4186cm ²	250	225	225	200	200
910	610	5551cm ²	300	300	250	250	225
910	760	6916cm ²	350	300	300	250	250
910	910	8281cm ²	350	350	300	300	250
910	1070	9737cm ²	-	350	350	300	300
1070	460	4922cm ²	300	250	250	225	200
1070	610	6527cm ²	300	300	300	250	250
1070	760	8132cm ²	350	350	300	300	250
1070	910	9737cm ²	•	350	350	300	300
1070	1070	11449cm ²	•	•	350	350	300
1070	1220	13054cm ²	•	•	•	350	350
1220	460	5612cm ²	300	300	250	250	225
1220	610	7442cm ²	350	300	300	300	250
1220	760	9272cm ²	•	350	350	300	300
1220	910	11102cm ²	•	•	350	350	300
1220	1070	13054cm ²	•	•	•	350	350
1220	1220	14884cm ²	•	•	•	350	350
1520	460	6992cm ²	300	300	300	250	250
1520	610	9272cm ²	•	350	350	300	300
1520	760	11552cm ²	•	•	350	350	300
1520	910	13831cm ²	•	•	•	350	350
1520	1070	16264cm ²	•	•	•	•	350
1520	1220	18544cm ²	•	•	•	•	•

- 1.3 The chimney or flue must be free from any obstruction. Any damper plates should be removed or secured in the fully open position, and no restrictor plates should be fitted.
- 1.4 The chimney should be swept prior to the installation of the appliance - unless it can be seen to be clean and unobstructed throughout its entire length.
- 1.5 Ensure that there is a smooth tapered transition from the fireplace opening into the chimney or flue.
- 1.6 The flue pull should be checked prior to installation of the appliance. Apply a smoke pellet to the flue or chimney opening and ensure that the smoke is drawn into the opening. If there is not a definite flow, pre-heat the chimney for a few minutes and re-test the flow.

IF THERE IS STILL NO DEFINITE FLOW, THE CHIMNEY MAY REQUIRE ATTENTION - SEEK EXPERT ADVICE.

2. INSTALLATION OF THE GAS SUPPLY

- 2.1 Before installation, ensure that the local distribution conditions (identification of the type of gas and pressure) and the adjustment of the appliance are compatible.
- 2.2 Ensure that the gas supply is capable of delivering the required amount of gas, and is in accordance with the rules in force.
- 2.3 Soft copper tubing and soft soldered joints can be used, but must not be closer than 50mm (2") to the base of the tray.
- 2.4 A means of isolating the gas supply to the appliance must be provided independent of any appliance control.
- 2.5 All supply gas pipes must be purged of any debris that may have entered prior to connection to the appliance.

3. VENTILATION

It is important to ensure that any national ventilation requirements are taken into account during the installation of this appliance.

- 3.1 This appliance requires an air vent of at least 100cm² effective area.
- 3.2 It is essential to check for flue clearance, see installation section 6, Commissioning. If spillage is detected, it may be necessary to provide additional ventilation.
- 3.3 The ventilation is in addition to any openable window, and although it must communicate with the outside air, wherever possible, it can communicate with an adjacent room provided that the space has a similar vent to the outside.

INSTALLATION INSTRUCTIONS

SITE REQUIREMENTS

4. APPLIANCE LOCATION

- 4.1 This appliance must stand on a non-combustible hearth that is at least 12mm thick.
- 4.2 It must be fitted into a non-combustible opening.
- 4.3 These appliances must be hearth mounted into a fireplace opening conforming to National Standards.
- 4.4 The appliance must be firmly fixed to the hearth.
- 4.5 Ensure that no naked flame or incandescent part of the fire bed projects beyond the vertical plane of the fireplace opening.
- 4.6 The appliance must not be installed in any room that contains a bath or shower.
- 4.7 Ensure clearances to combustible materials. See diagram 2.

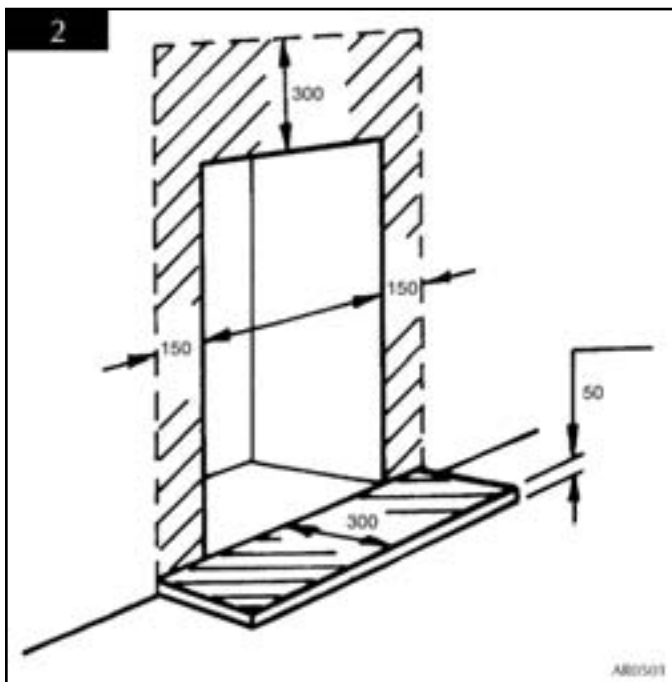

- 4.8 The following table indicates the minimum opening sizes for each model. In each case, a gap of 20mm has been allowed to both Left and Right of the basket. See diagram 3.

3

MODEL	WIDTH	DEPTH
SMALL ASPEN SMALL CHAMONIX	640mm	400mm
MEDIUM CHAMONIX	690mm	350mm
LARGE ASPEN LARGE CHAMONIX	790mm	500mm
TAHOE	670mm	300mm

5. CONTROL UPGRADE

- 5.1 This appliance is supplied with a control valve that can be easily upgraded to battery powered remote control. This upgrade can be fitted by anyone capable of simple DIY jobs and requires no special training. This upgrade can be obtained through your local GAZCO stockist.
- 5.2 STANDARD REMOTE CONTROL This remote control can control the fire after the pilot has been lit. It can turn the main burner on and regulate it from low through to high and back again. It can turn the main burner off leaving the pilot burning. GAZCO PART NUMBER 8455.

INSTALLATION INSTRUCTIONS

INSTALLATION

IMPORTANT: ENSURE THAT THE APPLIANCE IS CORRECTLY ADJUSTED FOR THE GAS TYPE AND CATEGORY APPLICABLE IN THE COUNTRY OF USE. REFER TO DATA BADGE AND TECHNICAL SPECIFICATIONS AT THE FRONT OF THE BOOKLET. FOR DETAILS OF CHANGING BETWEEN GAS TYPES REFER TO SERVICING SECTION 9.

1. SAFETY PRECAUTIONS

- 1.1 This appliance must be installed in accordance with the rules in force, and used only in a sufficiently ventilated space. Please read these instructions before installation and use of this appliance.
- 1.2 These instructions must be left intact with the user.
- 1.3 Do not attempt to burn rubbish on this appliance.
- 1.4 In your own interest, and those of safety, this appliance must be installed by competent persons in accordance with local and national codes of practice. Failure to install the appliance correctly could lead to prosecution.
- 1.5 Keep all plastic bags away from young children.

2. UNPACKING

- 2.1 Remove the appliance from its packaging, and check that it is complete and undamaged.
- 2.2 Put the loose ceramic parts to one side so that they are not damaged during installation.

3. INSTALLATION

These fires have preset High and Low settings with a Gas working pressure as listed below.

20mb on Natural Gas, 29mb on Butane and 37mb on Propane with the fire on full.

- 3.1 Ensure the minimum opening dimensions are correct, place the decorative basket in the opening ensuring that it sits centrally.
- 3.2 Place the gas fire unit centrally into the decorative basket and mark the fixing positions through the holes in the tray feet.

- 3.3 Remove both the decorative basket and fire, drill the marked holes and insert the rawplugs provided. Place the gas fire in position and secure to the hearth using the screws provided. See diagram 1.

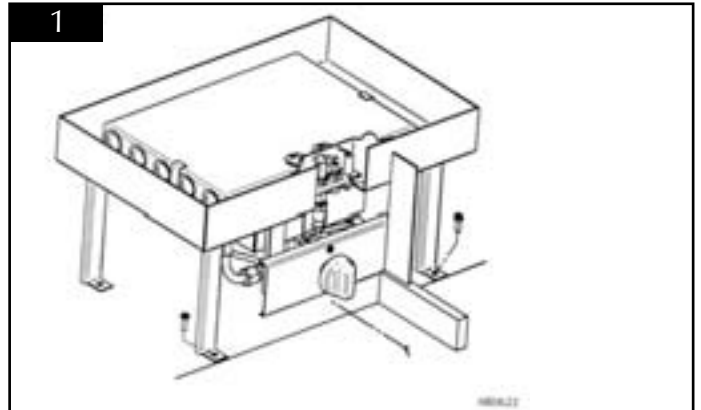

- 3.4 Connect the gas supply to the 8mm compression elbow situated to the right of the valve ensuring the supply pipe will not interfere with the fit of the decorative components. See diagram 2.

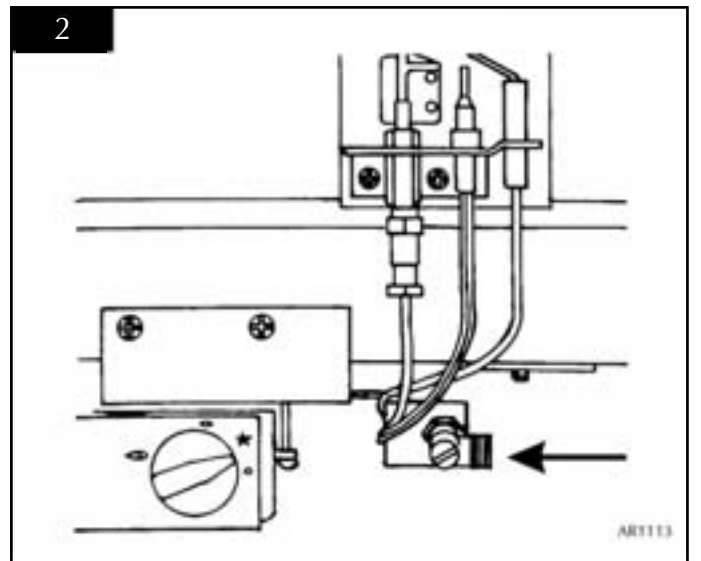

If the isolation tap is to be fitted under the fire, the GAZCO GC00060 provides a neat and easy solution.

- 3.5 Place the decorative components in place ensuring they sit centrally around the fire.

INSTALLATION INSTRUCTIONS

INSTALLATION

4. CONTROL UPGRADE

- 4.1 Your fire is fitted with a control valve that can be easily upgraded to battery powered remote control. This upgrade can be fitted by anyone capable of simple DIY jobs and requires no special training. This upgrade can be obtained through your local GAZCO stockist.
- 4.2 **STANDARD REMOTE CONTROL** This remote control can control the fire after the pilot has been lit. It can turn the main burner on and regulate it from low through to high and back again. It can turn the main burner off leaving the pilot burning. GAZCO PART NUMBER 8455.
- 4.3 The remote control receiver box is supplied with a 0.8 metre lead which attaches to the control valve. The receiver must be located in a position that will receive a signal from the handset and may be attached using the adhesive pads supplied in the instruction kit. The receiver must not be located on any surface which may become hot when the fire is in use.
- 4.4 **IMPORTANT** - there is a thermostatic version of the upgrade but this is **NOT SUITABLE** for open flame fires.

5. ARRANGEMENT OF FUEL BED COMPONENTS

NOTE: CERAMIC PARTS ARE FRAGILE.

5.1 General

- 5.1.1 Your fire will be supplied either with a ceramic Coal, Log, Pebble or Driftwood effect This will have been specified at the time of ordering. With pebble fires follow coal layouts. With driftwood fires follow log layouts.
- 5.1.2 Positioning of ceramic parts is important, not only for the flame effect, but also for optimum performance of the appliance.
- 5.1.3 It is important that the ceramic fuel effect pieces are placed so that there are gaps around each for the flames to pass through.
- 5.1.4 Ceramic components must only touch each other at single points, avoid whole sides touching.
- 5.1.5 Do not use any more ceramic components than those shown, extra parts supplied are spares and should be kept for future use.
- 5.1.6 The ceramic components should last about 2 years in normal use at which time it is recommended to replace them. Replacement parts can be bought from any stockist who supplies GAZCO fires, always state the model number found on the databadge.
- 5.1.7 The parts are supplied in various quantities depending on the size of the fire delivered. Check your coals, pebbles, driftwood and logs. If any are damaged, contact your Gazco stockist for replacements. Always ask for genuine Gazco parts.

- 5.1.8 Depending on the fuel effect that you have been supplied with, follow the correct section.

5.2 Glass Granules

- 5.2.1 If you have chosen the glass granular fuel effect, open the bag of glass granules and fill the fire to the top ensuring the granules finish level with the top of the tray.
- 5.2.2 Firmly pat the granules down to ensure that there are no voids below the surface. It is important to ensure that the granules fill all the gaps around the burner, and that the granules finish level with the top of the tray.

5.3 Firebeads

- 5.3.1 If you have chosen any other of the fuel effects (coal, pebble or log), it will be necessary to fill the tray with firebeads.
- 5.3.2 You will find 2 sizes of firebeads, large and small. Using the large beads, fill the fire to within 10mm of the top, level the beads and pat down. See diagram 3.

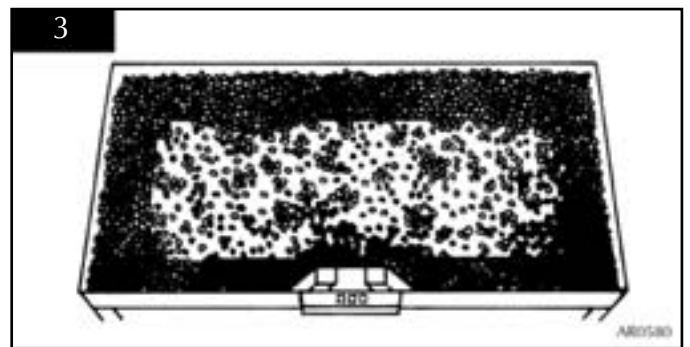

- 5.3.3 Using the small beads, fill the fire to the top. See diagram 4.

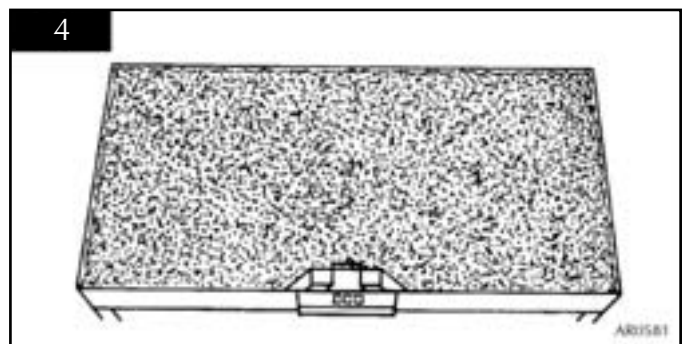

- 5.3.4 Smooth out the fire beads, it is important to ensure that the fire is completely filled, level to the top.
NOTE: if your fire needs more beads, then there should be some left over from the original installation, if not then more must be ordered from your Gazco stockist. Do not use any other type of material as this may seriously damage your fire and could be dangerous.
- 5.3.5 Firmly pat the beads down to ensure that there are no voids left below the surface.

INSTALLATION INSTRUCTIONS

INSTALLATION

5.3.6 Ensure that no beads have fallen into the pilot area.

5.3.7 Ensure that the pilot shield is fitted correctly and that it fits tightly onto the edge of the tray. See diagram 5.

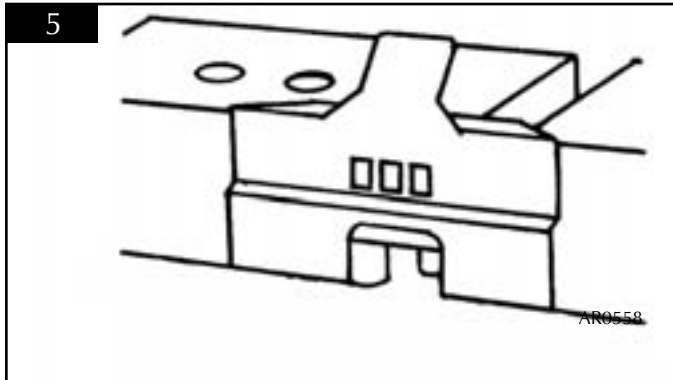

5.4 Coal & Pebble Layout - Small Aspen & Chamonix

5.4.1 Place 8 large square blocks in a solid mass in the centre of the burner tray as shown, ensure they fit tightly together. See diagram 6.

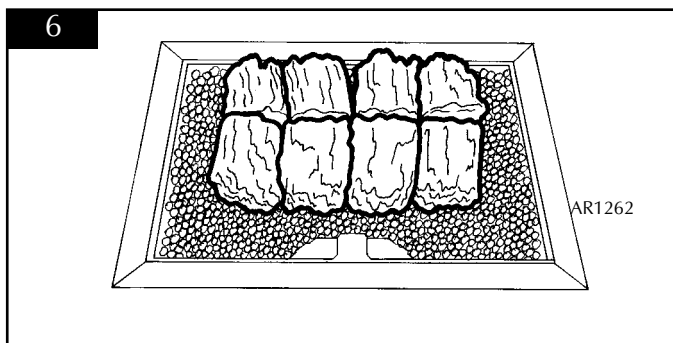

5.4.2 Place 14 small coals or pebbles around the edge of the tray as shown, ensure that there are gaps between each coal or pebble. Place one on top of the pilot shield. See diagram 7.

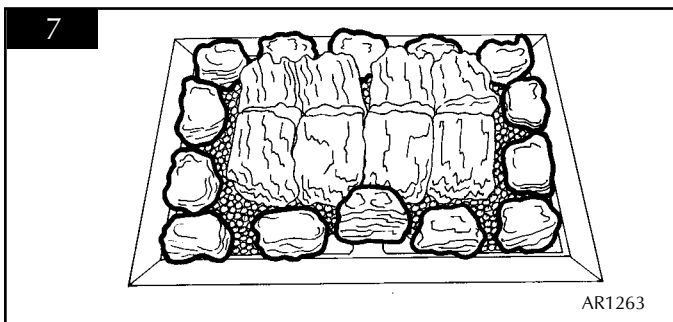

5.4.3 Starting at the front, place 14 alternating large and small coals or pebbles around the perimeter of the fire, they should sit on the bottom row of small coals or pebbles and rest against the inner mass of square blocks. See diagram 8.

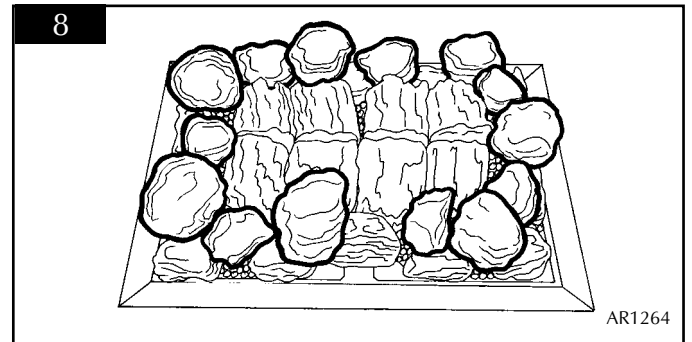

5.4.4 Place the remaining 6 large coals or pebbles on top of the square blocks, ensure that there are gaps between each coal or pebble. See diagram 9.

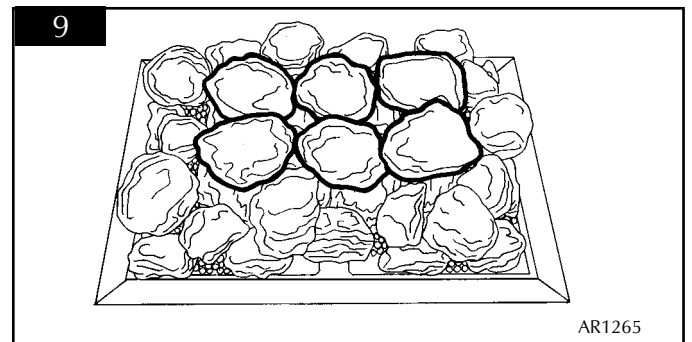

5.5 Coal & Pebble Layout - Medium Chamonix, Large Aspen & Chamonix

5.5.1 Place 15 large square blocks in a solid mass in the centre of the burner tray as shown, ensure they fit tightly together. See diagram 10.

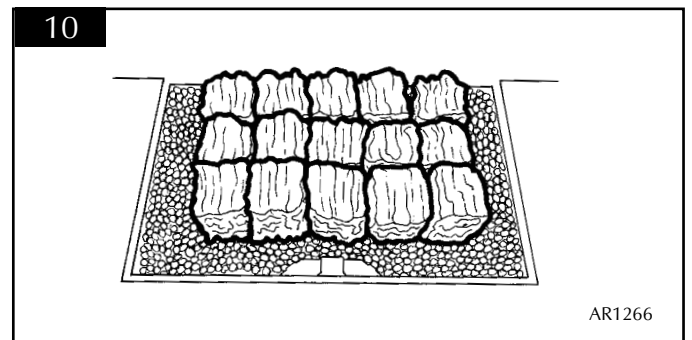

INSTALLATION INSTRUCTIONS

INSTALLATION

5.5.2 Place 18 small coals or pebbles around the edge of the tray as shown, ensure that there are gaps between each coal or pebble. Place one on top of the pilot shield. See diagram 11.

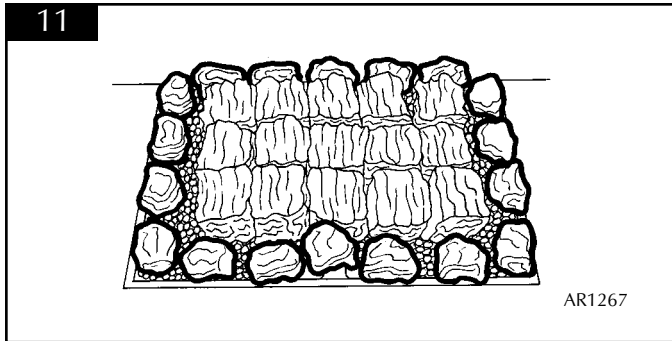

5.5.3 Starting at the front, place 18 alternating large and small coals or pebbles around the perimeter of the fire, they should sit on the bottom row of small coals or pebbles and rest against the inner mass of square blocks. See diagram 12.

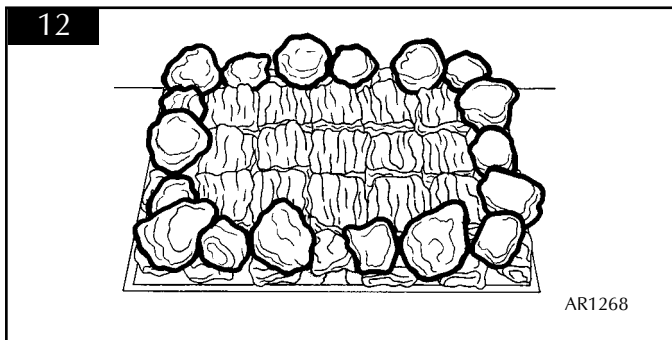

5.5.4 Place the remaining 11 large coals or pebbles on top of the square blocks, ensure that there are gaps between each coal or pebble. See diagram 13.

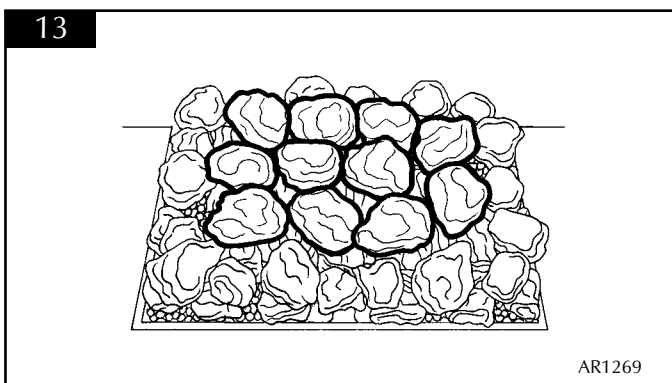

5.6 Coal & Pebble Layout - Tahoe

5.6.1 Place 10 small coals or pebbles around the edge of the tray as shown, ensure that there are gaps between each coal or pebble. See diagram 14.

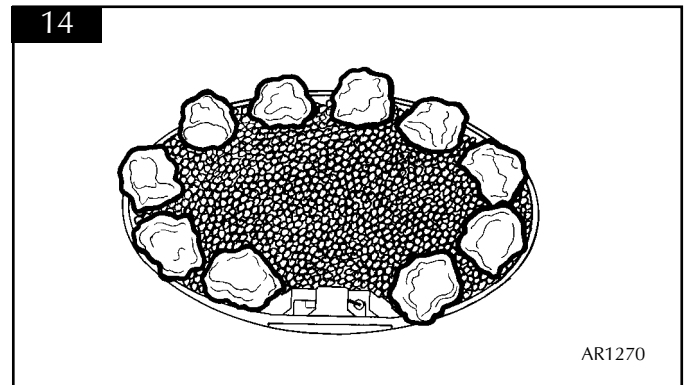

5.6.2 Place 6 large square blocks in a solid mass in the centre of the burner tray as shown, ensure they fit tightly together. See diagram 15.

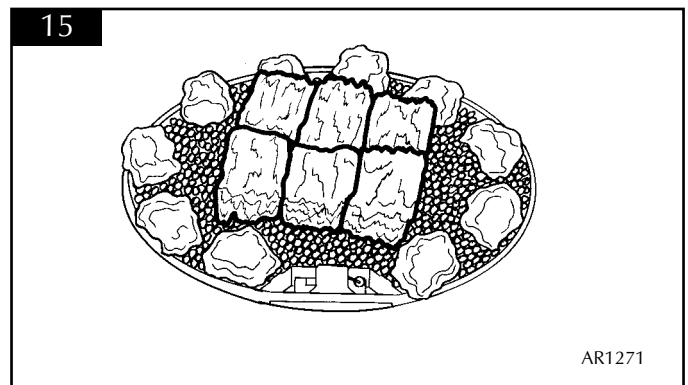

5.6.3 Place one large coal or pebble on top of the pilot shield, then place 10 alternating large and small coals or pebbles around the perimeter of the fire. They should sit on the bottom row of small coals or pebbles and rest against the inner mass of square blocks. Place one small coal or pebble on top of the centre of the square blocks. See diagram 16.

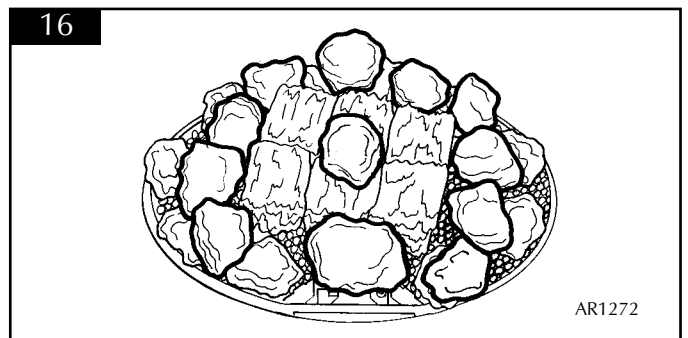

INSTALLATION INSTRUCTIONS

INSTALLATION

5.6.4 Place the remaining 4 large coals or pebbles on top of the square blocks, ensure that they lean against the central small coal or pebble and that there are gaps between each coal or pebble. See diagram 17.

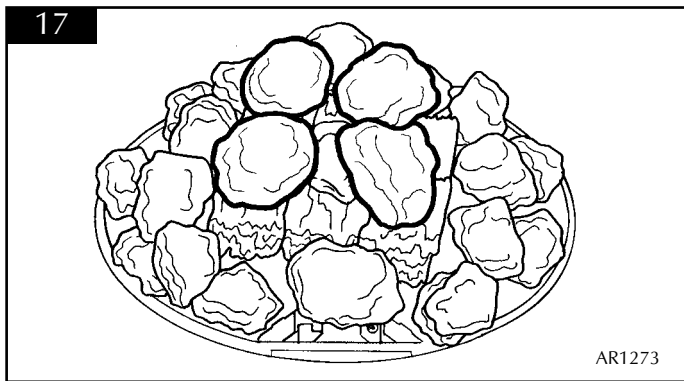

5.7 Log & Driftwood Layout – Small Aspen & Chamonix

It may be necessary to make small changes to the log positioning in order to achieve the most pleasing flame effect but the following guidelines should be followed.

5.7.1 Refer to the log identification chart and identify the numbers corresponding to the logs that have been supplied. See diagram 18

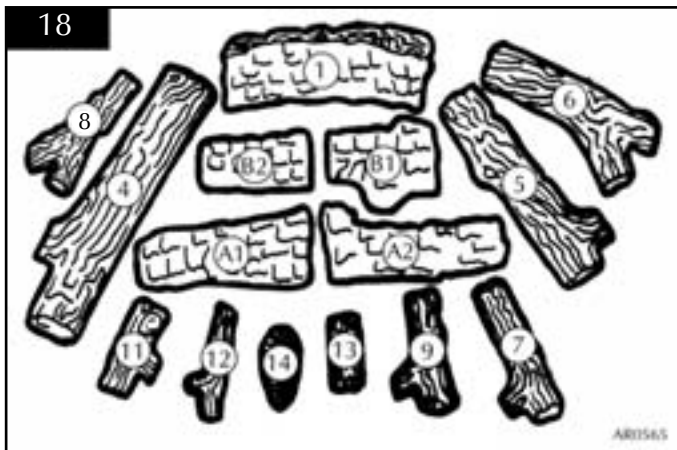

5.7.2 Place the two logs (No.13) on top of the beads as shown. See diagram 19.

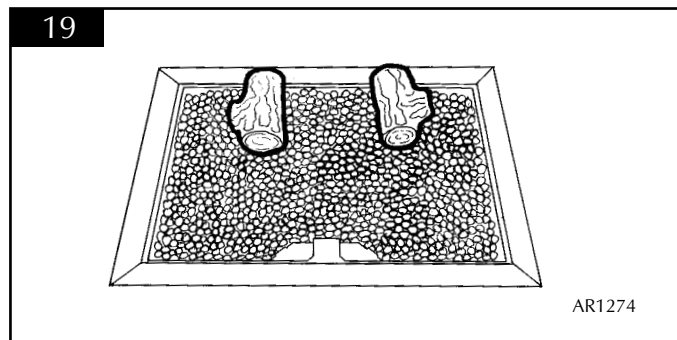

5.7.3 Place the large log (No. 1) so that it sits on top of the previous two logs. Place the burnt effect log (No. B1) in the centre of the tray as shown. See diagram 20.

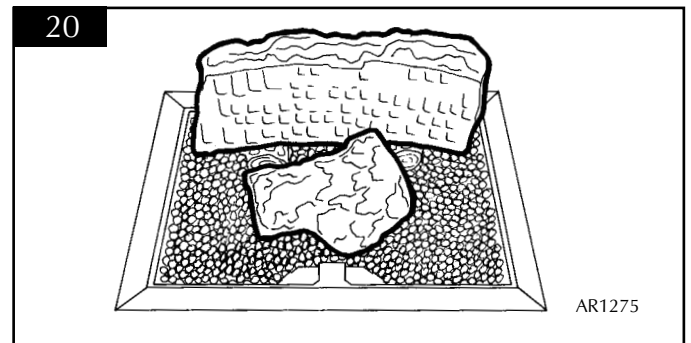

5.7.4 Place log (No. 7) along the LH side of the tray, log (No. 9) along the RH side of the tray and place logs (No. 8 and 11) along the front of the tray as shown. Place the cone (No. 14) on the LH side of the burnt log. See diagram 21.

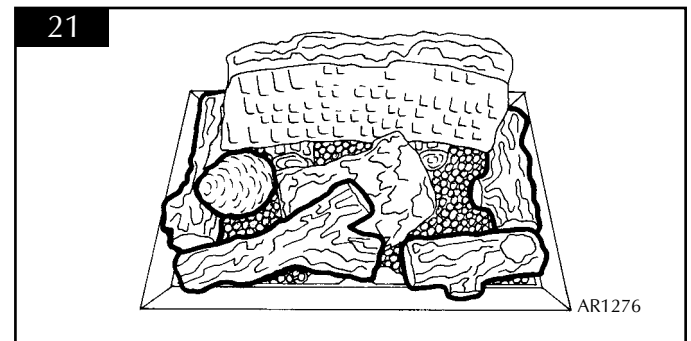

5.7.5 Place the large log (No. 6) so that it rests on top of the rear and front logs to the LH side, Place log (No. 7) on the RH side and log (No. 8) so that it bridges the centre gap as shown. See diagram 22.

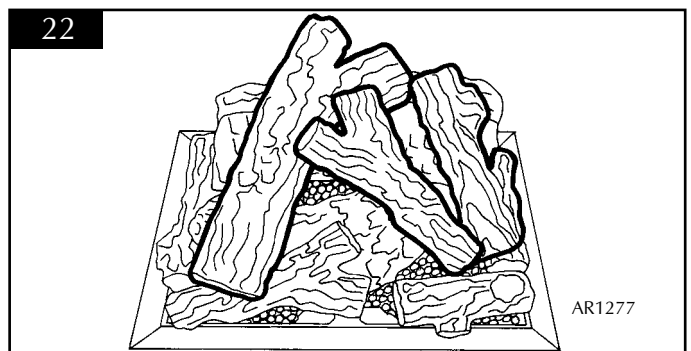

INSTALLATION INSTRUCTIONS

INSTALLATION

5.8 Log & Driftwood Layout – Medium Chamonix, Large Aspen & Chamonix

It may be necessary to make small changes to the log positioning in order to achieve the most pleasing flame effect but the following guidelines should be followed.

- 5.8.1 Refer to the log identification chart and identify the numbers corresponding to the logs that have been supplied. See diagram 23.

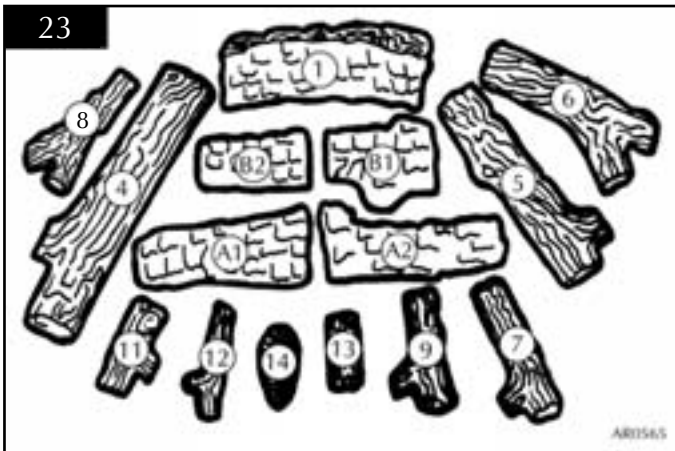

- 5.8.2 Place the two logs (No.13) on top of the beads as shown. See diagram 24.

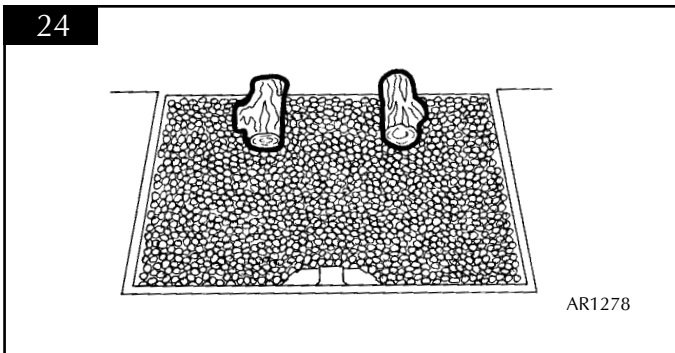

- 5.8.3 Place the large log (No. 1) so that it sits on top of the previous two logs. Place the burnt effect log (No. A1) in the centre of the tray as shown. Place one log (No. 7) along each side of the tray, another log (No. 7) along the front LH side and a log (No. 8) along the front RH side of the tray. See diagram 25.

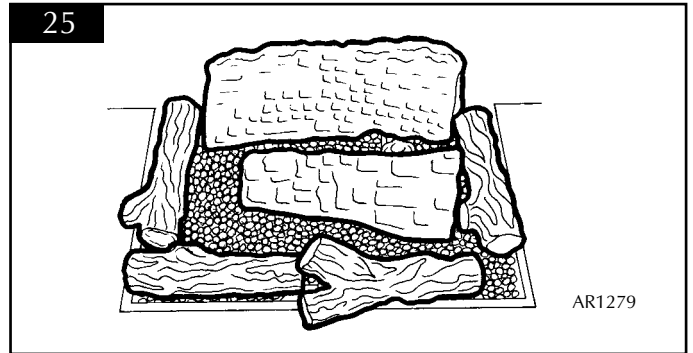

- 5.8.4 Place two cones (No. 14), one in the RH front corner and the other at the LH side of the burnt log. See diagram 26.

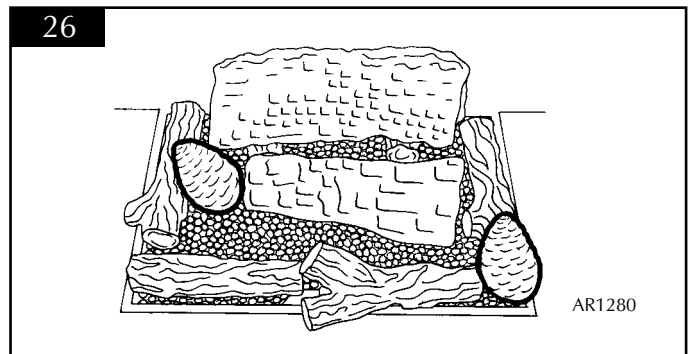

- 5.8.5 Place one large log (No. 6) so that it rests on top of the rear and front logs to the LH side. Place the other large log (No. 6) so that it rests on top of the rear and front logs on the RH side and log (No. 8) so that it bridges the centre gap as shown. See diagram 27.

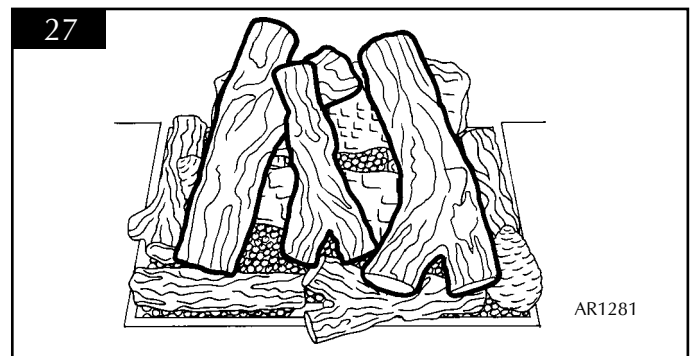

INSTALLATION INSTRUCTIONS

INSTALLATION

5.9 Log & Driftwood Layout – Tahoe

It may be necessary to make small changes to the log positioning in order to achieve the most pleasing flame effect but the following guidelines should be followed.

5.9.1 Refer to the log identification chart and identify the numbers corresponding to the logs that have been supplied. See diagram 28.

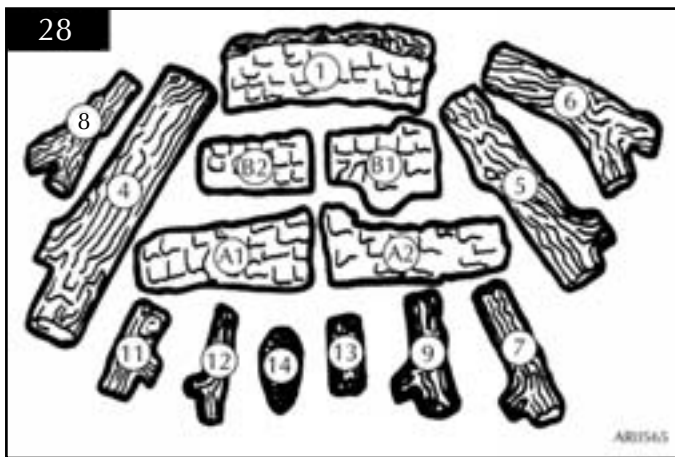

5.9.2 Place a cone (No. 14) in the centre at the rear edge of the tray and place one log (No. 13) at each side of the cone. Place one log (No. 11) along the front of the tray at each side of the pilot. See diagram 29.

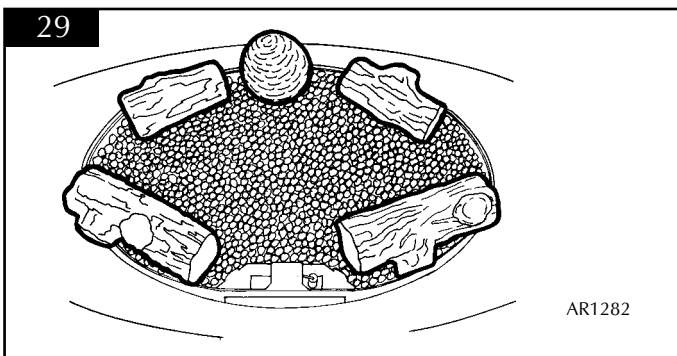

5.9.3 Place the burnt effect log (No. B1) in the centre of the tray. See diagram 30.

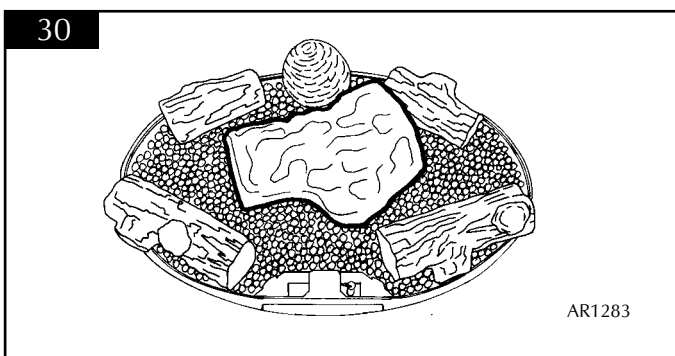

5.9.4 Place one log (No. 8) in the centre so that it rests on the rear cone and the pilot shield. See diagram 31.

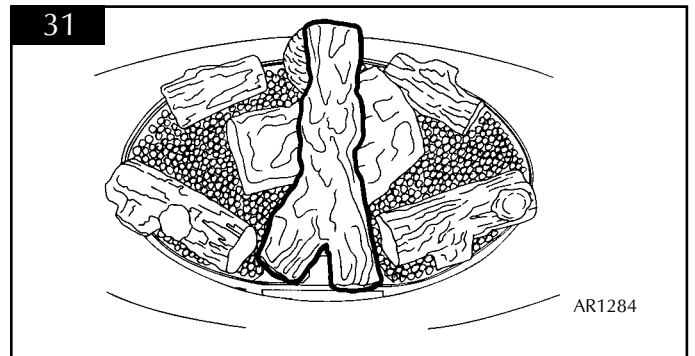

5.9.5 Place one log (No. 11) so that it rests on the LH front log and the burnt log. Place another log (No. 7) so that it rests on the RH front log and the burnt log. See diagram 32.

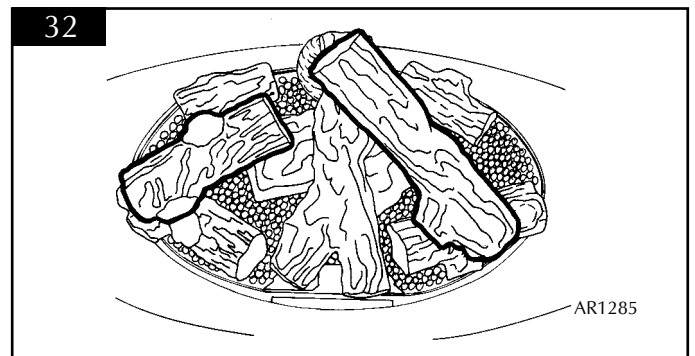

5.9.6 Place the two thin logs (No. 12), one at each side sitting on the tray and resting against the previously positioned logs. Place one log (No. 9) at the LH rear resting on the base log, and one log (No. 8) at the RH rear. See diagram 32.

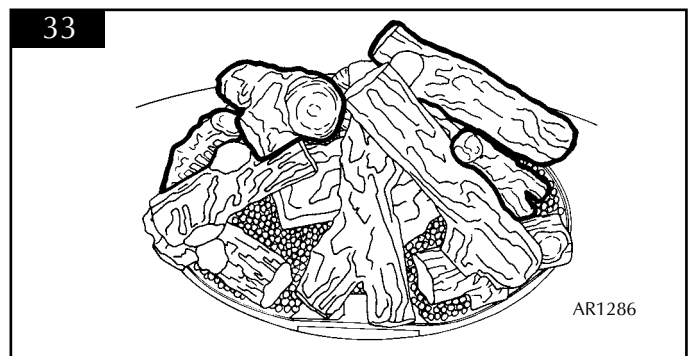

INSTALLATION INSTRUCTIONS

COMMISSIONING

6. COMMISSIONING

- 6.1 Close all windows and doors to the room, check all controls, and allow fire to burn on maximum for 5 minutes. Test for spillage of flue products using a smoke match. Pass the lighted smoke match along the top front edge just inside the opening or canopy. See diagram 34.

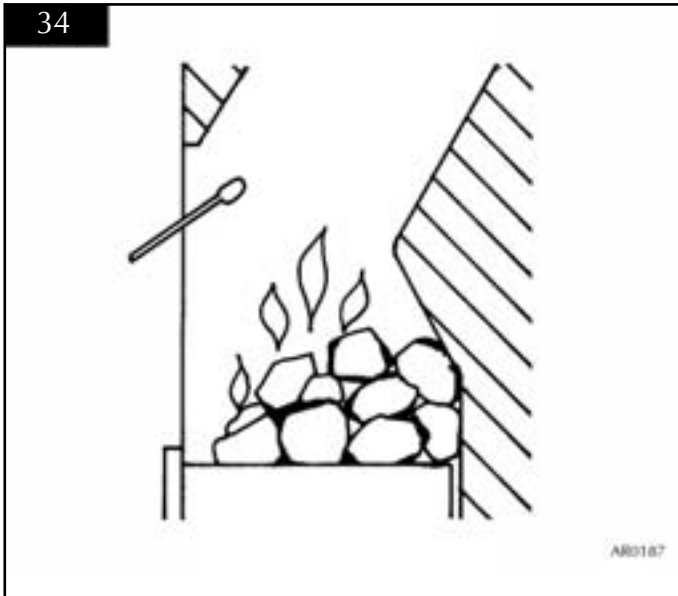

- 6.2 If the fire spills, run for a further 10 minutes and re-check. If there is still spillage, disconnect the fire and seek expert advice
- 6.3 If there are extractor fans in the room or adjacent rooms, the spillage test must be repeated with the extractors running on maximum.
- 6.4 The burner pressure on this appliance is pre-set, provided the correct inlet pressure is obtained at the test point on the inlet connection, with the appliance on full, the appliance will work correctly. Carrying out a gas rate test will check the correct operation.
(The test points on the gas valve are not used on this appliance.)

SERVICING INSTRUCTIONS

SERVICING / FAULT FINDING CHARTS

1. SERVICING REQUIREMENTS

This appliance must be serviced at least once a year by a competent person.

All tests must be serviced by best practice as described by the current CORGI recommendations.

- 1.1 Before any tests are undertaken on the appliance, conduct a gas soundness test for the property to ensure that there are no gas leaks prior to starting work.
- 1.2 Before any tests are undertaken on the appliance it is also recommended to fully check the operation of the appliance.
- 1.3 Special checks
 - 1.3.1 Clean any lint or fluff from the pilot - pay particular attention to the aeration hole in the side of the pilot
 - 1.3.2 Clean away any fluff or lint from under the burner
 - 1.3.3 Check that the spark gap on the pilot is correct
- 1.4 Correct any faults found during the initial tests and then re-commission the appliance conducting the usual safety checks.
- 1.5 Advise the customer of any remedial action taken.

FAULT	CAUSE/POSSIBLE REMEDY
a) Pilot will not light	See Ignition Functional Check 1
b) No spark	See Ignition Functional Check 2
c) Pilot will not stay lit or fire goes out in use	See Flame Failure Functional Check
d) Uneven flame pattern, for example to one side only.	<ol style="list-style-type: none"> 1. The fuel effect may need adjusting to even the flame pattern. 2. Ensure there are no excessive room draughts from open doors, windows etc.
e) Blue flame	<ol style="list-style-type: none"> 1. The fire will burn blue on initial lighting, until the heat generated allows the gas to burn yellow, typically within 20 mins. 2. Insufficient gas pressure, check pressure setting. 3. The aeration plate may be set wrongly.
f) Low flame height	<ol style="list-style-type: none"> 1. This may be caused by low gas pressure, therefore: Check gas pressure 2. The visual effect of these fires is controlled by the placing of the fuel effect, try slight adjustments.
g) Popping	<ol style="list-style-type: none"> 1. Some popping will always be present - severe popping can be caused by incorrect burner pressure. 2. Not enough clay beads. 3. Try slight adjustments to the fuel effect.

SERVICING INSTRUCTIONS

FAULT FINDING CHARTS

IGNITION FUNCTIONAL CHECK 2

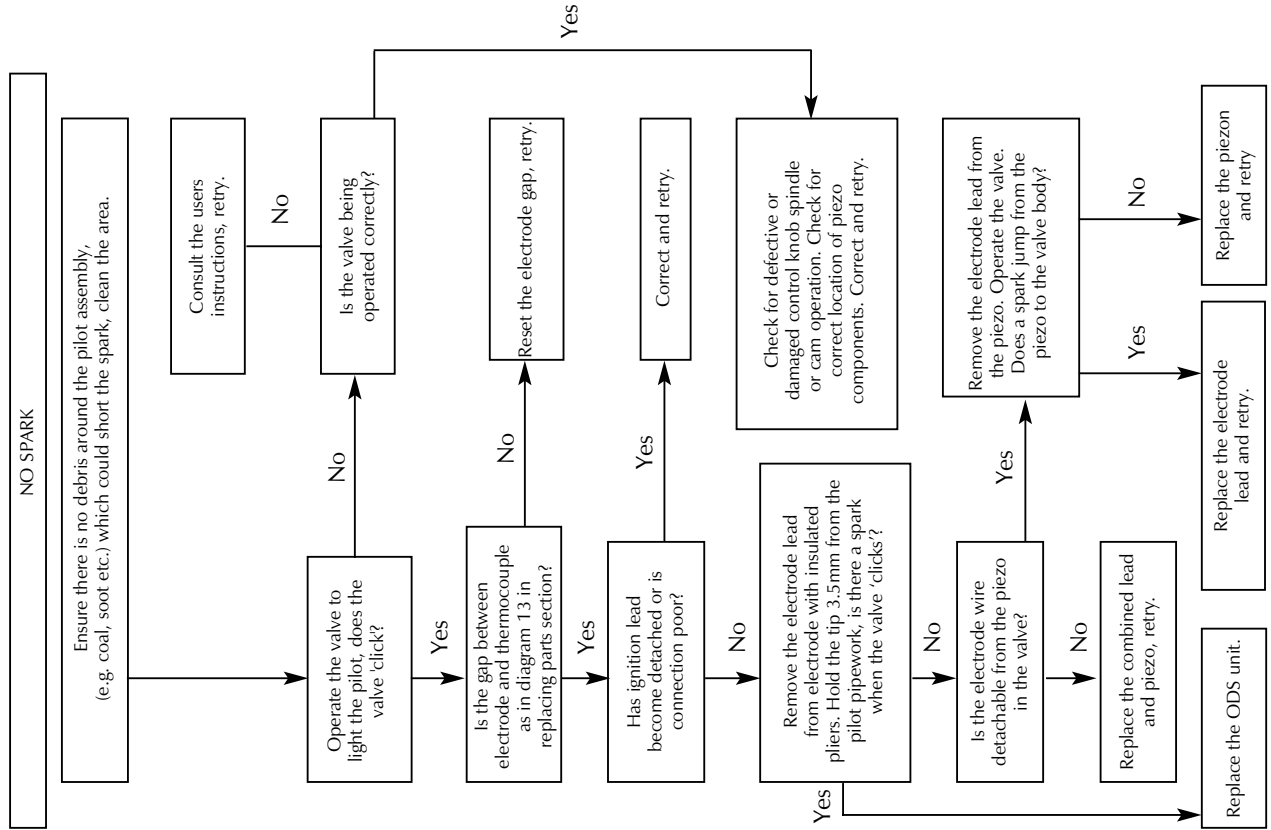

IGNITION FUNCTIONAL CHECK 1

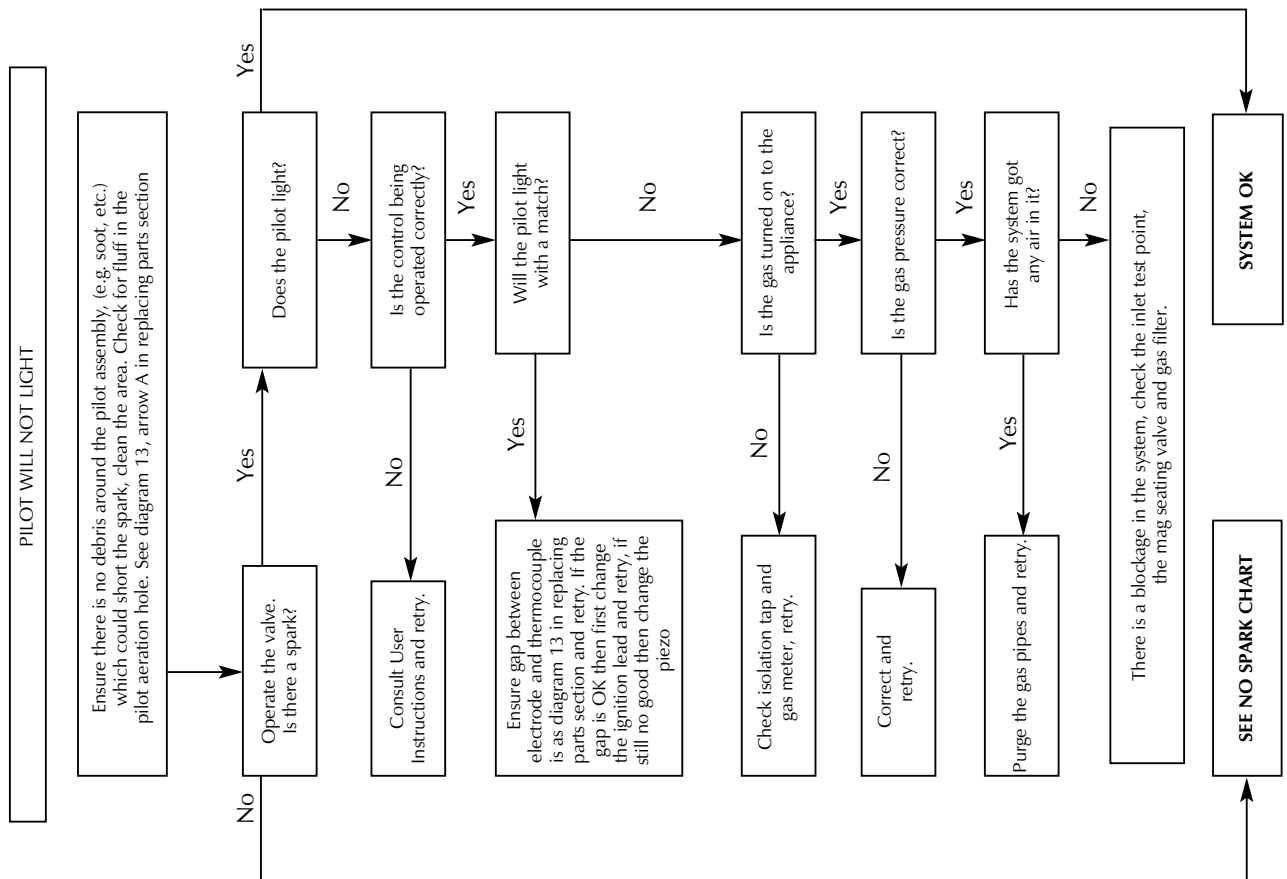

FLAME FAILURE FUNCTIONAL CHECK 3

SERVICING INSTRUCTIONS FAULT FINDING CHARTS

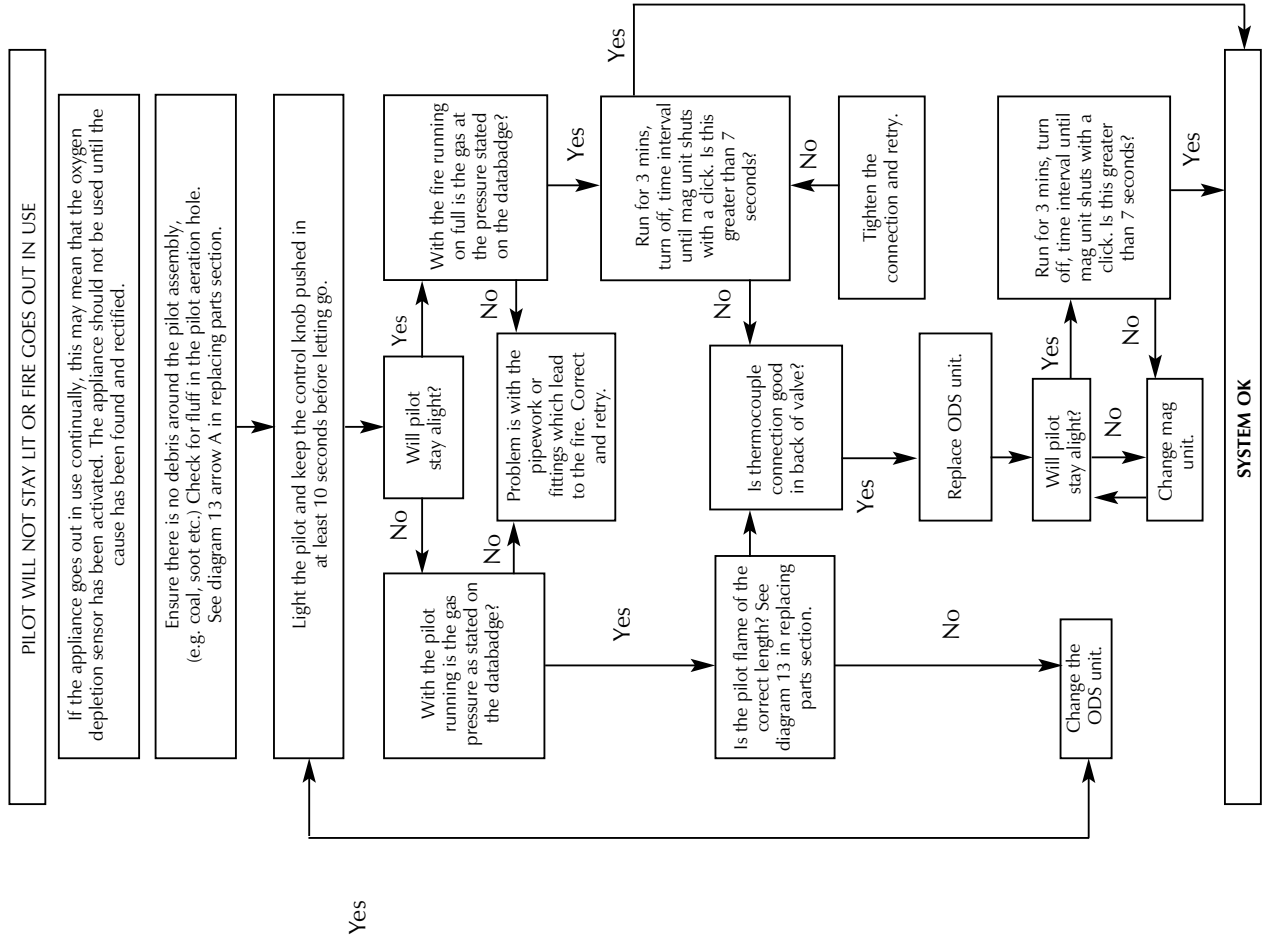

SERVICING INSTRUCTIONS

REPLACING PARTS

1. FIRE REMOVAL

- 1.1 Turn the gas supply off at the isolation device, remove the decorative ashpan cover and disconnect the gas supply pipe from the inlet.
- 1.2 Carefully remove all the loose ceramic fuelbed pieces and place on a dry clean surface.
- 1.3 Remove the outer decorative basket and place to one side.
- 1.4 Undo the two screws securing the fire to the hearth. See diagram 1.

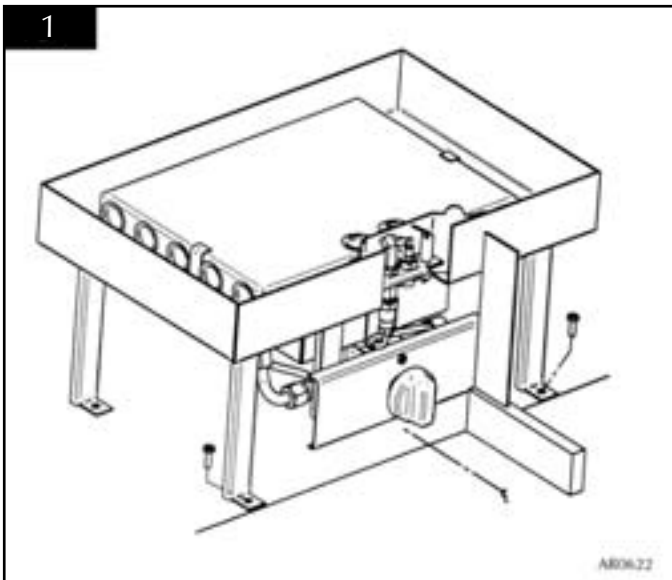

- 1.5 Lift the fire away from the hearth and carefully tip the firebeads (or glass granules if applicable) into a dry clean container for later replacement.

2. IGNITION LEAD

- 2.1 It should be possible to replace the ignition lead without removing the fire, if this proves difficult the the fire should be removed, see section 1.
- 2.2 Undo the screw that secures the left-hand side of the control cover. See diagram 2.

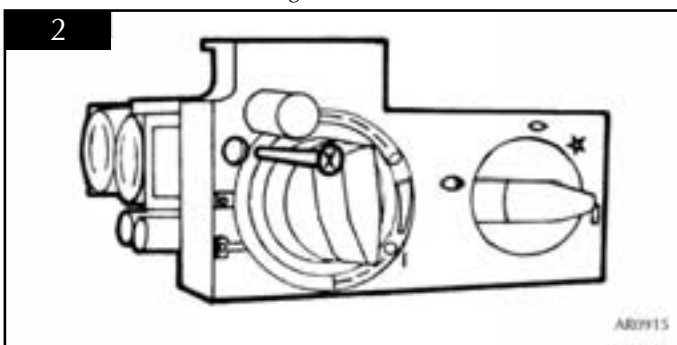

- 2.3 To release the right hand side of the control cover insert a narrow blade screwdriver into the slot shown in diagram 3, lever it gently and pull from the right hand side at the same time. The cover will now come off, there is a small cylindrical spacer inside the cover, this must be kept and replaced on the fixing screw during re-assembly.

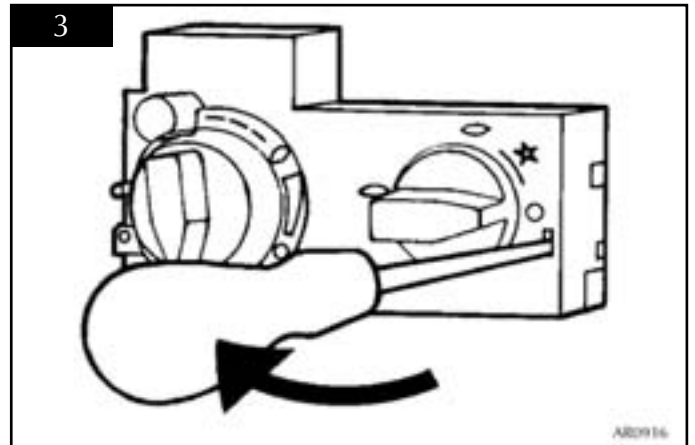

- 2.4 Disconnect the ignition lead from the gas valve and gently pull the other end off the pilot electrode. See diagram 4.

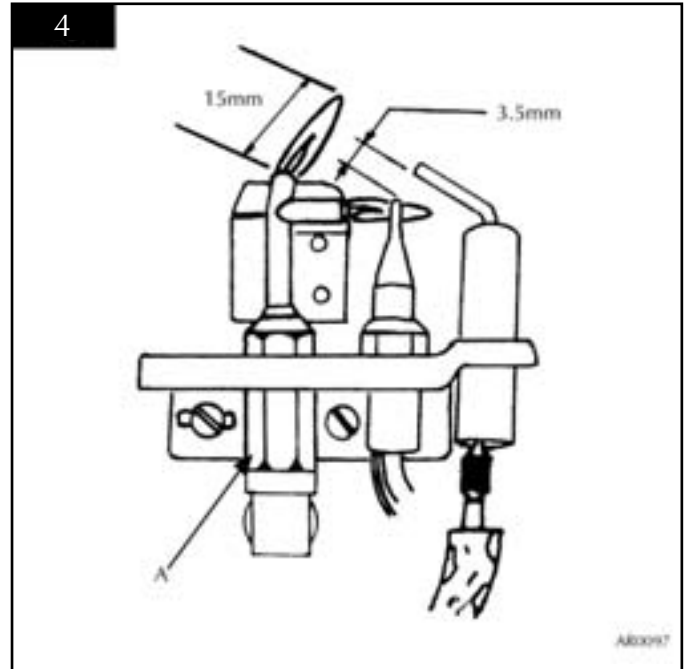

SERVICING INSTRUCTIONS

REPLACING PARTS

- 2.5 replace with a new ignition lead following the same route as the old one. replace the valve cover and securing screw.
- 2.6 check the operation of the new ignition lead.

3. PIEZO

- 3.1 The piezo unit used on this appliance is not serviceable and unlikely to fail. If a new piezo is required it will be necessary to change the gas valve, refer to section 7.

4. ODS PILOT UNIT

- 4.1 Remove the fire, see section 1.
- 4.2 Remove the pilot shield and place to one side. Gently pull the ignition lead off the electrode. See diagram 5.

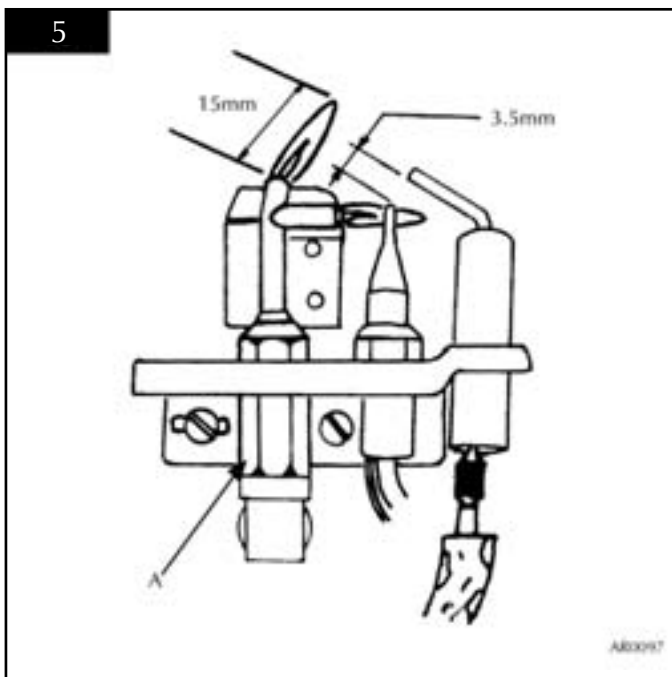

- 4.3 Undo the thermocouple connection from the back of the gas valve and carefully pull the thermocouple clear of the pipework and valve. See diagram 6, arrow A.

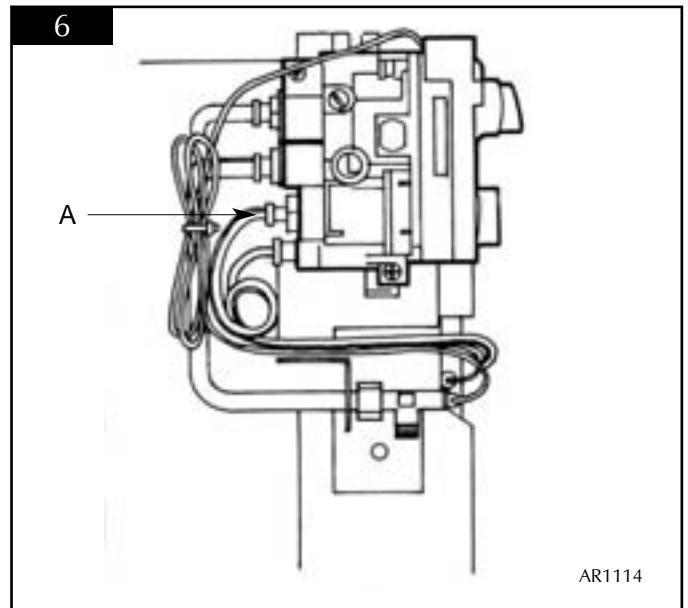

- 4.4 Undo the pilot pipe connection from the pilot unit, remove the 2 screws securing the pilot and remove the pilot assembly. See diagram 7.

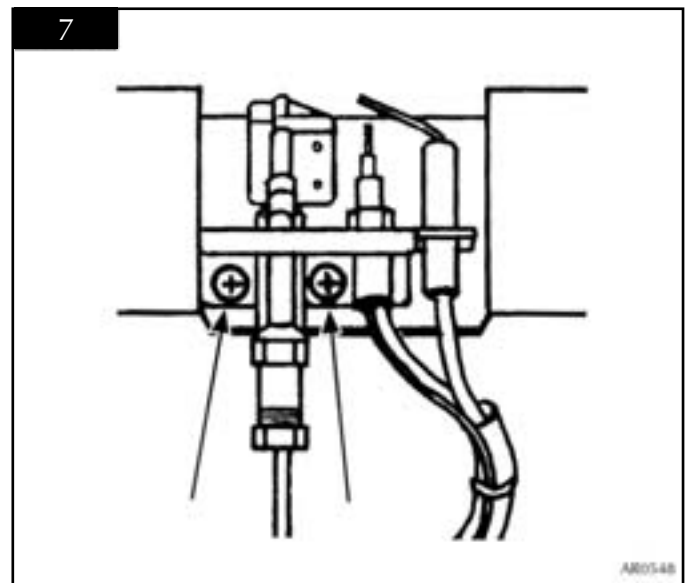

- 4.5 Replace with a new pilot unit of the correct type (refer to short spares list) and re-assemble. Set the spark gap as shown in diagram 5, replace the appliance and check the pipework for gas soundness, especially the inlet connection and pilot pipe connection.
- 4.6 Carry out flame failure functional check as detailed in the flow chart paying particular attention to the mag drop out time.

SERVICING INSTRUCTIONS

REPLACING PARTS

5. MAGNETIC UNIT

- 5.1 Remove the thermocouple from the back of the control valve. See diagram 8 arrow B.

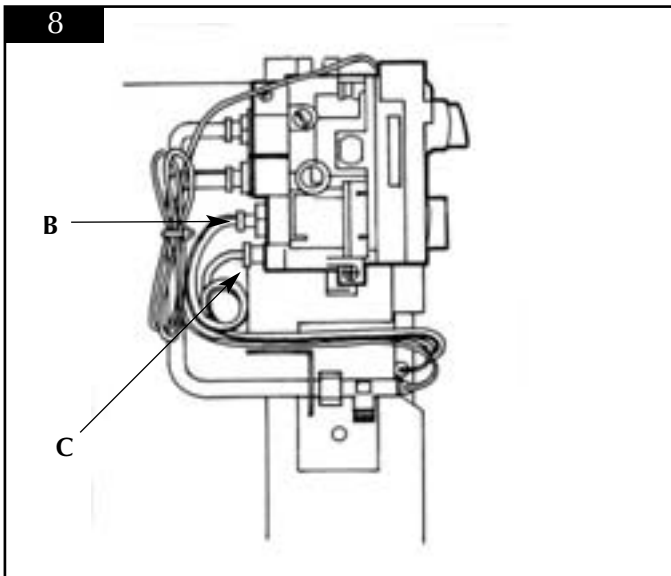

- 5.2 Undo the mag unit retaining nut. See diagram 8, arrow C
- 5.3 After removing the retaining nut, the mag unit can be tapped out and a replacement fitted.
- 5.4 Replace the mag unit retaining nut and tighten.
Note - this is a gas tight seal.
- 5.5 Replace thermocouple and check for gas leaks.
- 5.6 After reassembly, carry out the flame failure functional check, detailed in the flow chart following, particularly the mag unit drop out time.

6. MAIN INJECTOR

- 6.1 Remove the fire. See section 1.
- 6.2 With the fire removed, where appropriate undo the injector compression nut.
- 6.3 Rotate the injector until it is fully removed.
- 6.4 Replace with the correct replacement injector. When ordering always state the model, gas type and serial number.
- 6.5 After re-assembly, check for gas leaks.

7. PRIMARY AERATION PLATE

- 7.1 Locate the aeration plate on the underside of the airbox and remove the Nyloc nut, see diagram 9.
- 7.2 When replacing the aeration plate, ensure that the hole in the aeration plate is correctly aligned to one of the holes in the underside of the airbox, replace the Nyloc nut.

NOTE: ENSURE THE CORRECT SIZE AERATION HOLE IS ALIGNED WITH ONE OF THE HOLES IN THE AERATION BOX - SEE TECHNICAL SPECIFICATION. LPG APPLIANCES DO NOT REQUIRE A PRIMARY AERATION PLATE

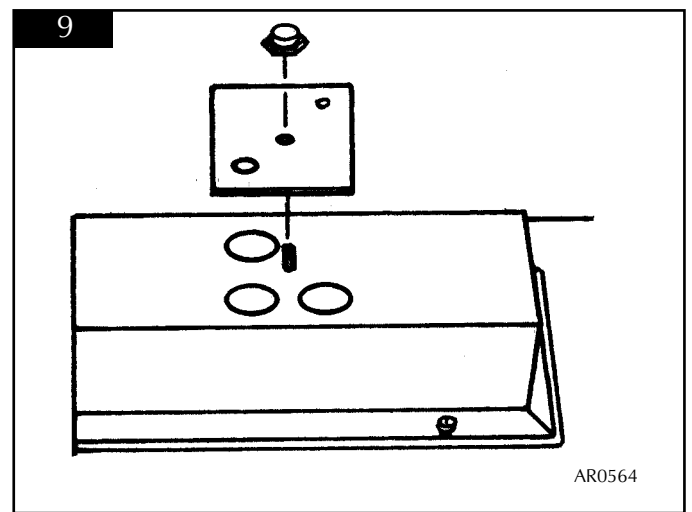

SERVICING INSTRUCTIONS

REPLACING PARTS

8. GAS VALVE

- 8.1 Remove the fire, refer to section 1.
- 8.2 Disconnect the 2x8mm and 1x4mm gas pipe fittings at the back of the gas valve, arrow A and disconnect the thermocouple. See diagram 10 arrow B.

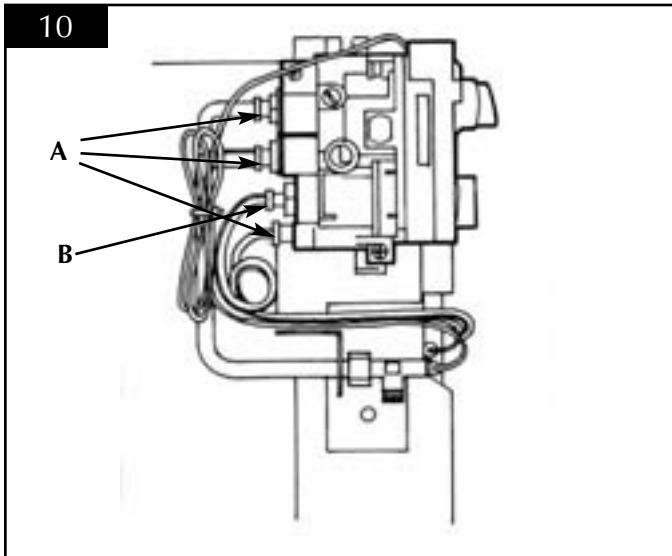

- 8.3 Undo the single screw that secures the left-hand side of the control cover. See diagram 11.

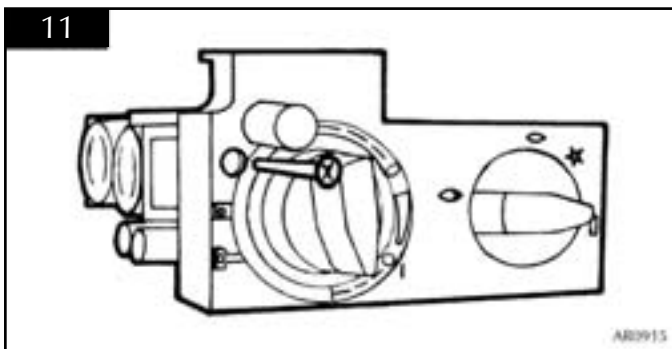

- 8.4 To release the right hand side of the control cover, insert a narrow blade screwdriver into the slot shown in diagram 12, lever it gently and pull from the right hand side at the same time. The cover will now come off. There is a small cylindrical metal spacer inside the cover, this must be kept and replaced on the fixing screw during re-assembly.

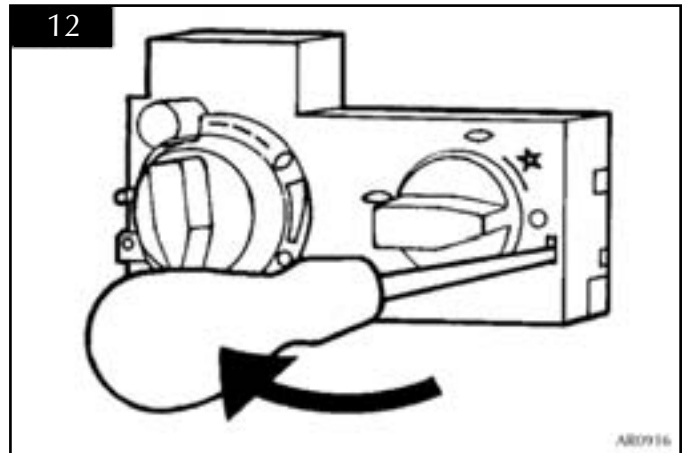

- 8.5 Disconnect the ignition lead from the gas valve, see section 2.
- 8.6 Undo the two screws securing the gas valve to the control bracket and remove the valve.
- 8.7 Replace in reverse order.
- 8.8 Check all joints for gas leaks; check operation of the thermocouple and ignition lead.

9. CHANGING BETWEEN GAS TYPES

- 9.1 The following parts must be changed when converting from one gas type to another:

- Engine Assembly
- Air Box Gasket
- Pilot Assembly
- Databadge

Please note: The control valve will be preset for the correct gas type and model number.

SERVICING INSTRUCTIONS

REPLACING PARTS

9. SHORT SPARES LIST

COMMON COMPONENTS

Control Valve	GC0096
Ignition lead	GC0090
Magnetic Unit	GC0092
Control Cover	GC0087
Upgrade Kit	8455
Pilot Shield (Standard)	GZ1368
Pilot Shield (Glass Granules)	GZ4424
Small Clay Beads (0.5 ltr)	CE0239
Small Clay Beads (1.0 ltr)	CE0240
Large Clay Beads (1.0 ltr)	CE0241
Large Clay Beads (2.0 ltr)	CE0242
Glass Granules	CE0489
Small Moulded Coals (9)	CE0216
Small Moulded Coals (14)	CE0235
Large Moulded Coals (6)	CE0217
Large Moulded Coals (9)	CE0236
Sqaure Coals (Black)	CE0007
Square Coals (White)	CE0460
Small Pebbles (9)	CE0456
Small Pebbles (14)	CE0457
Large Pebbles (6)	CE0458
Large Pebbles (9)	CE0459
A1 Burnt Log	CE0220
B1 Burnt Log	CE0222
No. 1 Log	CE0224*
No. 6 Log	CE0227*
No. 7 Log	CE0228*
No. 8 Log	CE0229*
No. 9 Log	CE0230*
No.11 Log	CE0231*
No.12 Log	CE0232*
No.13 Log	CE0233*
No.14 Pine Cone	CE0234*

Natural Gas Components

1100 Injector	IN0013
1600 Injector	IN0010
Pilot Unit	PI0047
Aeration Plate	ME0833

LPG Gas Components

400 Injector	IN0007
600 Injector	IN0026
Pilot Unit	PI0048

*DW Suffix indicates driftwood effect.

SERVICE RECORDS

1ST SERVICE

Date of Service:.....
Next Service Due:.....
Signed:.....
Dealer's Stamp/CORGI Registration Number

2ND SERVICE

Date of Service:.....
Next Service Due:.....
Signed:.....
Dealer's Stamp/CORGI Registration Number

3RD SERVICE

Date of Service:.....
Next Service Due:.....
Signed:.....
Dealer's Stamp/CORGI Registration Number

4TH SERVICE

Date of Service:.....
Next Service Due:.....
Signed:.....
Dealer's Stamp/CORGI Registration Number

5TH SERVICE

Date of Service:.....
Next Service Due:.....
Signed:.....
Dealer's Stamp/CORGI Registration Number

6TH SERVICE

Date of Service:.....
Next Service Due:.....
Signed:.....
Dealer's Stamp/CORGI Registration Number

7TH SERVICE

Date of Service:.....
Next Service Due:.....
:.....
Dealer's Stamp/CORGI Registration Number

8TH SERVICE

Date of Service:.....
Next Due:.....
Signed:.....
Dealer's Stamp/CORGI Registration Number

9TH SERVICE

Date of Service:.....
Next Due:.....
Signed:.....
Dealer's Stamp/CORGI Registration Number

10TH SERVICE

Date of Service:.....
Next Service Due:.....
Signed:.....
Dealer's Stamp/CORGI Registration Number

Gazco Limited, Osprey Road, Sowton Industrial Estate, Exeter, Devon, England EX2 7JG
Tel: (01392) 261999 Fax: (01392) 444148 E-mail: info@gazco.com

A member of the Stovax Group