

[DBI SALA 8516996 Advanced Portable Fall Arrest Post](#)

ISO 9001 REGISTERED

&

CE CERTIFIED

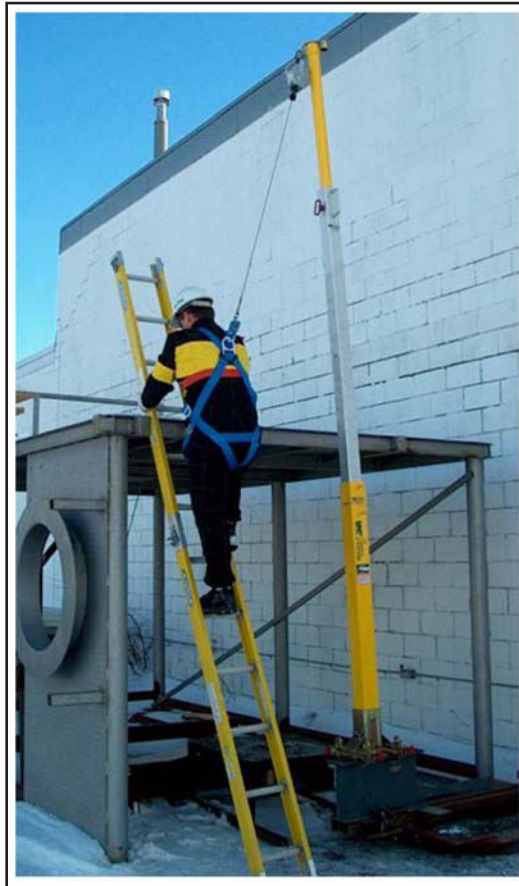

**MAN RATED
CONFINED SPACE
ENTRY/RETRIEVAL SYSTEMS
UCL ADVANCED PORTABLE 14' FALL-ARREST POST
OPERATOR'S MANUAL**

LIMITED WARRANTY

This Limited Warranty is given exclusively to:

Name

Address

Telephone No.

by Unique Concepts Ltd. ("Unique Concepts") in respect of the following product(s) manufactured by it (the "Products"):

Subject to the conditions and restrictions contained in this Limited Warranty, Unique Concepts warrants to the Customer that the Products are free from defects in materials and workmanship under normal use and service for a period of twelve (12) months from the date the Products are purchased by the Customer, in new and unused condition, from Unique Concepts or its agent (the "Warranty Period"). Unique Concepts' entire liability and the Customer's exclusive remedy regarding any such defects is limited to the repair or replacement of the defective Products (as Unique Concepts, in its sole discretion, deems appropriate) which are returned to Unique Concepts in accordance with the procedures set forth below.

Terms and Conditions

1. This Limited Warranty will be void unless:
 - (a) this Limited Warranty is fully completed by or on behalf of the Customer and returned to Unique Concepts within fourteen (14) days following the date the Customer purchases the Products, by registered mail addressed to: Unique Concepts Ltd., 1500 King Edward Street, Winnipeg, Manitoba, R3H 0R5 (the "Manufacturer's Address");
 - (b) written notice of any defect is delivered to the Manufacturer's Address by registered mail within five (5) days after any defect in the Products becomes apparent; and
 - (c) any defective Products in respect of which the Customer wishes to make a warranty claim are delivered to Unique Concepts, with all postage or freight charges prepaid, within the Warranty Period and no later than fourteen (14) days after any defect in the Products becomes apparent.

2. This Limited Warranty shall not apply to any Products which have been used with unapproved assemblies or sub-assemblies, or which have been customized or modified, altered, damaged or misused.

3. Following the repair or replacement of any defective Products in respect of which a warranty claim is validly made by the Customer, or, alternatively, following the date Unique Concepts determines either that the warranty given hereby has been voided or that the returned Products do not exhibit any defects in materials or workmanship, Unique Concepts will return the Products to the Customer. All such shipments will be made to the Customer's address listed above, and will be at the Customer's sole expense.

4. The Customer will incur all risk of loss, theft or damage to the Products during shipment to Unique Concepts and during their subsequent return to the Customer. Without limiting the foregoing, the common carrier chosen by Unique Concepts to return the Products to the Customer will be deemed to be an agent of the Customer.

5. If, on its inspection of any Products returned to it by the Customer, Unique Concepts determines that such Products require maintenance or repairs which are outside the scope of its warranty obligations. Unique Concepts may contact the Customer with a view to obtaining authorization (which may be written or oral) to complete such maintenance or repairs at rates then customarily charged by Unique Concepts to its customers. The Customer hereby releases and indemnifies Unique Concepts, together with its directors, officers, agents, employees, successors and assigns, and anyone else who has been involved in the inspection of the Products returned by the Customer, from all claims, losses, expenses and damages (including damages for loss of business profits, business interruption, loss of business information, loss of health or for any other loss whatsoever) arising directly or indirectly, as a result of the failure by Unique Concepts to perform or adequately perform any maintenance or repairs which are outside the scope of its warranty obligations hereunder, whether or not resulting from any negligent or improper inspection of such Products, or from the failure of the Customer to authorize the performance of such maintenance or repairs.

6. THE WARRANTY SET OUT HEREIN IS THE ONLY WARRANTY OF ANY KIND, EITHER EXPRESS OF IMPLIED, STATUTORY OR OTHERWISE (INCLUDING BUT NOT LIMITED TO THE IMPLIED WARRANTIES OR MERCHANTABILITY AND FITNESS FOR A PARTICULAR PURPOSE) THAT IS MADE BY UNIQUE CONCEPTS. WITHOUT LIMITING THE GENERALITY OF THE FOREGOING, UNIQUE CONCEPTS DOES NOT WARRANT THAT THE PRODUCTS WILL MEET ALL REQUIREMENTS OF ALL APPLICABLE LAWS, REGULATIONS OR OTHER ENACTMENTS APPLICABLE IN EACH JURISDICTION IN WHICH THEY MAY BE USED OR STORED, OR THE REQUIREMENTS OF THE CUSTOMER.

7. NO ORAL OR WRITTEN INFORMATION OR ADVICE GIVEN BY UNIQUE CONCEPTS, ITS DEALERS, DIRECTORS, OFFICERS, DISTRIBUTORS, AGENTS OR EMPLOYEES SHALL CREATE A WARRANTY OR IN ANY WAY INCREASE THE SCOPE OF THIS LIMITED WARRANTY, AND THE CUSTOMER MAY NOT RELY ON ANY SUCH INFORMATION OR ADVICE.

8. THE CUSTOMER AGREES THAT, TO THE MAXIMUM EXTENT PERMITTED UNDER APPLICABLE LAW, NEITHER UNIQUE CONCEPTS NOR ITS DEALERS, DIRECTORS, OFFICERS, DISTRIBUTORS, AGENTS OR EMPLOYEES, OR ANYONE ELSE WHO HAS BEEN INVOLVED IN THE CREATION, PRODUCTION OR DELIVERY OF THE PRODUCTS, WILL BE LIABLE FOR ANY DIRECT, INDIRECT, CONSEQUENTIAL OR INCIDENTAL DAMAGES (INCLUDING DAMAGES FOR LOSS OF BUSINESS PROFITS, BUSINESS INTERRUPTION, LOSS OF BUSINESS INFORMATION, LOSS OF HEALTH OR ANY OTHER LOSS WHATSOEVER) ARISING OUT OF THE USE OR INABILITY TO USE SUCH PRODUCT, EVEN IF UNIQUE CONCEPTS HAS BEEN ADVISED OF THE POSSIBILITY OF SUCH DAMAGES.

9. The Customer is not entitled to assign this Limited Warranty to any party. To the maximum extent permitted under applicable law, and at its sole discretion, Unique Concepts is entitled to assign its obligations hereunder to any third party.

10. This Limited Warranty is governed by the laws of the Province of Manitoba and will benefit Unique Concepts and its successors and assigns.

ACKNOWLEDGEMENT

THE CUSTOMER ACKNOWLEDGES THAT HE/SHE HAS READ THIS LIMITED WARRANTY, UNDERSTANDS IT, AND AGREES TO BE BOUND BY ITS TERMS AND CONDITIONS. THE CUSTOMER FURTHER AGREES THAT THIS LIMITED WARRANTY CONTAINS THE COMPLETE AND EXCLUSIVE STATEMENT OF AGREEMENT BETWEEN THE PARTIES, AND SUPERSEDES ALL PROPOSALS OR PRIOR AGREEMENTS ORAL AND WRITTEN, AND ANY OTHER COMMUNICATIONS BETWEEN THE PARTIES, RELATING TO THE SUBJECT MATTER OF THIS LIMITED WARRANTY.

Date

Customer

WARRANTY VOID IF NOT REGISTERED

UNIQUE CONCEPTS

CONFINED SPACE ENTRY/RETRIEVAL UCL ADVANCED PORTABLE 14 FOOT FALL-ARREST SYSTEM

WARRANTY REGISTRATION FORM & INSPECTION REPORT

WARRANTY REGISTRATION (please print)

This form must be filled out by the dealer and signed by both the dealer and the customer at the time of delivery.

Customer's Name _____	Dealer Name _____
Address _____	Address _____
City, State/Province, Code _____	City, State/Province, Code _____
Phone Number (____) _____	Phone Number (____) _____
Contact Name _____	Manufactured by: Unique Concepts Ltd. 1500 King Edward Street Winnipeg, Manitoba, Canada R3H 0R5 Phone Number (204) 694-7432 Toll Free 1-800-455-9673
Model _____	
Serial Number _____	
Delivery Date _____	

DEALER INSPECTION REPORT

- All Fasteners Torqued
- Check that all fasteners and mechanical components are present
- Check Winch with Winch Warranty Card
- No Mechanical Damage
- Check for finish damage

SAFETY

- All Labels Installed Correctly and Legible
- Review Operating and Safety Instructions

I have thoroughly instructed the buyer on the above described equipment which review included the Operator's Manual content, equipment care, adjustments, safe operation and applicable warranty policy.

Date _____ Dealer's Rep. Signature _____

The above equipment and Operator's Manual have been received by me and I have been thoroughly instructed as to care, adjustments, safe operation and applicable warranty policy.

Date _____ Owner's Signature _____

WHITE	YELLOW	PINK
UNIQUE CONCEPTS	DEALER	CUSTOMER

SERIAL NUMBER LOCATION

Always give your dealer or distributor the serial number of your **UCL ADVANCED Portable 14 Foot Fall-Arrest Post** when ordering parts or requesting service or other information.

The serial number plate is located where indicated. Please mark the number in the space provided for easy reference.

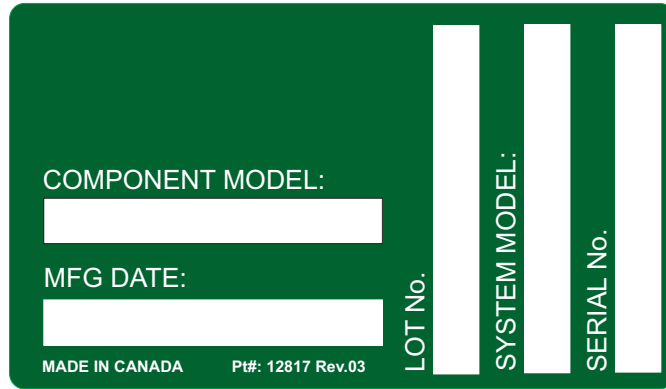

SERIAL NUMBER LABEL

Model _____

Serial Number _____

TABLE OF CONTENTS

SECTION	DESCRIPTION	PAGE
1	INTRODUCTION	1
2	SAFETY	2
2.1	General Safety	3
2.2	Operating Safety	4
2.3	Maintenance and Inspection Safety	4
3	OPERATING, NEW OPERATOR OR OWNER	5
3.1	Portable 14' Fall-Arrest Post	7
3.1.1	General	
3.1.2	Setting Up the Portable Fall-Arrest Post	
3.2	Mounting Bases	11
3.2.1	General	
3.2.2	Installing the Weld On Plate	
3.2.3	Installing the Portable Mounting Bases	
3.2.4	Set-up of the Portable Fall-Arrest Post	
3.3	Storage	12
4	MAINTENANCE AND INSPECTION	13
4.1	Maintenance	
4.2	Inspection	
4.3	Inspection Log	
5	LABELS	17
5.1	Warning Labels	
6	SPECIFICATION SHEETS	18

Congratulations on your purchase of a UCL Advanced Safety Systems Portable Fall Arrest System. This equipment has been designed and manufactured to meet the needs of a discriminating operator in the variety of fall-arrest, confined space entry/retrieval and rescue situations.

Safe, efficient and trouble free operation and maintenance of your equipment requires that you or anyone else who will be operating, maintaining or inspecting the equipment, read, understand and follow all the Safety, Operation, Maintenance and Inspection instructions contained in this manual, and in any related manuals referenced in this manual and/or supplied with the system.

This manual covers the **UCL ADVANCED PORTABLE FALL-ARREST SYSTEM** and Accessories manufactured by Unique Concepts. Use the Table of Contents or Index as a guide when searching for specific information.



WARNING

This product is a part of a Man Rated Confined Space Entry/Retrieval System. The user must read, understand, and follow the instructions contained in the manual for each component or total system before using this equipment. Establish an appropriate training, maintenance, and inspection program for your people and the equipment. Failure to follow these instructions could result in serious injury or death.

Keep this manual handy for frequent reference and to pass to new operators. Establish a regular training program for experienced and new operators per these instructions. Establish a regular maintenance and inspection program to keep the equipment in top condition.

The **UCL ADVANCED PORTABLE FALL-ARREST SYSTEM** is a modular system of Portable Fall Arrest Anchor Posts, Extensions, and Support Bases designed to address a wide variety of Fall-Arrest and Confined Space Entry/Retrieval and Rescue applications.

Modular components are labelled with the capacities and rating to which they were designed, tested, and manufactured. The rating of any system is considered to be the rating of the lowest rated component contained in the system.

Do not use the equipment if rating labels are damaged or illegible. New labels are available from the manufacturer or your local authorized dealer. When ordering replacement labels, be sure to include:

- 1) The part number from the bottom right hand corner of the label, when available.
- 2) The serial number of the unit.
- 3) The part (item) number of the component (consult the appropriate section of this manual).
- 4) Any other numbers stamped on the components.

SAFETY ALERT SYMBOL

This Safety Alert symbol means
ATTENTION! BECOME ALERT!
YOUR SAFETY IS INVOLVED!

The Safety Alert symbol identifies important safety messages on your UCL Equipment and in the manual. When you see this symbol, be alert to the possibility of personal injury or death. Follow the instructions in the safety message.



Why is SAFETY important to you?

3 Big Reasons

Accidents Disable and Kill
Accidents Cost You Money
Accidents Can Be Avoided

SIGNAL WORDS:

Note the use of the signal words **DANGER**, **WARNING**, and **CAUTION** with the safety messages. The appropriate signal word for each message has been selected using the following guide-lines:

DANGER - Indicates an imminently hazardous situation that, if not avoided, will result in death or serious injury. This signal word is to be limited to the most extreme situations, or for hidden or unseen hazards.

WARNING - Indicates a potentially hazardous situation that if not avoided, could result in death or serious injury, and includes obvious and hidden hazards. It may also be used to alert against unsafe practices.

CAUTION - Indicates a potentially hazardous situation that, if not avoided, may result in minor or moderate injury. It may also be used to alert against unsafe practices.

SAFETY

YOU are responsible of the **SAFE** operation, maintenance and inspection of your UCL Advanced Portable Fall-Arrest System. **YOU** must ensure that you and anyone else, who is going to operate, maintain, inspect or work around the equipment be familiar with the operating and maintenance procedures and related **SAFETY** information contained in this manual. This manual will take you step-by-step through your working day and alerts you to all good safety and operating practices while using the equipment.

Remember, **YOU** are the key to safety. Good safety practices not only protect you, but also the people around you. Make these practices a working part of your safety program. Be certain that **EVERYONE** operating this equipment is familiar with the procedures recommended and follows safety precautions. Remember, most accidents can be prevented. Do not risk injury or death by ignoring good safety practices.

- Owners must give operating instructions to operators or employees before allowing them to use the equipment, and at least annually thereafter.
- The most important safety device on this equipment is a **SAFE** operator. It is the operator's responsibility to read and understand **ALL** Safety and Operating instructions in the manual and to follow these. All accidents can be avoided.
- A person who has not read, been trained in using and understood all operating and safety instructions is not qualified to operate this equipment. An untrained operator exposes himself and others to possible serious injury or death.
- Do not modify the equipment in any way. Unauthorized modification may impair the function and/or safety and could affect the life of the equipment.
- Think SAFETY! Work SAFELY!

2.1 GENERAL SAFETY

1. Read, understand and follow the User Manual and all safety signs before using, maintaining or inspecting the equipment.
2. Refer to and follow applicable **ANSI, OSHA, CE** or other Standards and local regulations. Comply with requirements of local regulations for your applications.
3. Establish an equipment–use training program for experienced employees. Only trained, competent persons shall use the equipment. An untrained operator is not qualified to operate the system.
4. Have a first-aid kit available for use should the need arise and know how to use it.
5. Provide a fire extinguisher for use in case of an accident. Store in a highly visible place.
6. Install and properly secure all guards and shields before operating.
7. Wear appropriate protective gear. This list includes but is not limited to:
 - A hard hat
 - Safety glasses
 - Protective shoes with slip resistant soles
 - Heavy gloves
 - Protective clothing
 - Face protection
8. Review and follow the Pre-Operation Inspection before using a component in the system or the system itself.
9. Establish a regular Maintenance and Inspection program with your equipment and maintain detailed records.
10. Review safety related items and operating instructions with all personal on a regular basis.
11. Be aware of your environmental surroundings, be sure not to use the equipment during an electrical storm. (this equipment is conductive)
12. When using our winch with our equipment, the noise level does not exceed 70 dB(A).

2.2 OPERATING SAFETY

1. Read, understand and follow the User Manual and signs on the equipment before using, maintaining or inspecting the equipment.
2. Train all operators before allowing them to use the equipment. An untrained operator exposes themselves, bystanders and co-workers to possible serious injury or death.
3. Visually inspect the equipment and all auxiliary components and equipment before using. Correct any problems before using the equipment.
4. Securely anchor all winches and /or SRL's before using, where applicable.
5. Use only certified anchor and connector components in your system.
6. Use only an approved full body harness for the workers.
7. Always work in teams. One person works in the confined space and the other one pays out the line and reels it in.
8. Do not use the winch when the brake wear indicator displays excessive wear, the overload indicator on the snap has been activated, or the manufacturer's service interval has been exceeded. Return winch to manufacturer for service. (Refer to the appropriate Winch Operators Manual for detailed information on winch operation.)
9. Do not exceed the winch's rated working load during operation.
10. Establish a regular training program for new and experienced workers.
11. Establish a detailed inspection program for your equipment and document the findings. Return the equipment to the manufacturer for rework if any problems are found.
12. Plan your work program before starting. Have the required people, equipment and procedures available to do the job.
13. Do not use the equipment around physical or environmental hazards. This list includes but is not limited to:
 - a. Corrosion that may affect the structural integrity of the life line or other components .
 - b. Chemicals which can degrade components and not be visible.
 - c. Toxic gases: Rescuers or workers can be killed in toxic environments.
 - d. Heat or elevated temperatures.
 - e. Moving machinery: Workers or auxiliary equipment can be contacted by or pulled into moving components.
 - f. Sharp edges: Workers or the equipment can be injured or damaged by sharp edges or components.
 - g. Electrical hazards: Stay away from power lines or components carrying electrical power.
 - h. Overload: Do not exceed rated working load limit during operation.
 - i. Follow confined space regulations in Standards.

2.3 MAINTAINANCE/INSPECTION SAFETY

1. Read, understand and follow the User Manual and signs on the equipment before using, maintaining or inspecting the equipment.
2. **ANSI, OSHA & CE** require a regular inspection program for all Confined Space Entry/Retrieval Equipment and to maintain documented results of these inspections. Follow the inspection procedure contained in this manual and use the inspection form to document the results.
3. Keep instructional and safety signs clean and legible at all times. Clean or replace as required.
4. Lubricate winch as per instructions in the appropriate Winch Operators Manual.
5. Remove the equipment from service if a problem is found during the inspection. Return to an authorized repair depot or the factory for service.

3 OPERATING, NEW OPERATOR OR OWNERS

The **UCL ADVANCED PORTABLE FALL-ARREST SYSTEM** is designed to attach to a person working at a height to provide protection against injuries resulting from a fall. Various accessories address a variety of fall-arrest requirements, as well as confined space entry/retrieval and rescue needs. Every new operator must read, understand and follow the instructions in all applicable manuals. No one should be allowed to use the equipment without training. The training should be reviewed with experienced operators on a regular basis. At regular intervals perform a detailed inspection of the equipment and document the results. Remove from service if deficiencies are found. Alterations or misuse of this equipment or failure to follow instructions, may result in serious injury or death.

It is the responsibility of the owner's organization or operator to read this manual and to train all other operators before they start working with the equipment. Follow all safety instructions exactly. Safety is everyone's business. By following recommended procedures, a safe working environment is provided for the operator, bystanders and the area around the work site. Untrained operators are not qualified to operate the equipment.

Many features incorporated into this equipment are the result of suggestions made by customers like you. Read this manual carefully to learn how to operate the equipment safely and how to set it to perform as intended. By following the operating instructions in conjunction with a good maintenance program, your equipment will provide many years of trouble-free service.



OPERATING SAFETY

1. Read, understand and follow the User Manual and signs on the equipment before using, maintaining or inspecting the equipment.
2. Train all operators before allowing them to use the equipment. An untrained operator exposes themselves, bystanders and workers to possible serious injury or death.
3. Visually inspect the equipment and all auxiliary components and equipment before using. Correct any problems before using the equipment.
4. Securely anchor the winch before using.
5. Use only certified anchor and connector components in your system.
6. All anchor points, or mounting/setup locations for permanent or portable systems must be approved to local standards by a qualified engineer.
7. Use only an approved body harness for the workers.
8. Always work in teams. One person works in the confined space and the other one pays out the line and reels it in.
9. Do not use the winch when the brake wear indicator displays excessive wear, the overload indicator on the snap has been activated, or the manufacturer's service interval has been exceeded. Return winch to manufacturer for service. (Refer to the appropriate Winch Operators Manual for detailed information on winch operation.)
10. Use only retractable lifelines or shock absorbers with a maximum arrest force (MAF) rating equal to or lower than $\frac{1}{2}$ of the strength of the lowest rated component of your system.
11. Establish a regular training program for new and experienced workers.
12. Establish a detailed inspection program for your equipment and document the findings. Return the equipment to the manufacturer for rework if any problems are found.
13. Plan your work program before starting. Have the required people, equipment and procedures available to do the job.
14. Do not use the equipment around physical or environmental hazards. This list includes but is not limited to:
 - a. Corrosion that may affect the structural integrity of the life line or other components.
 - b. Chemicals which can degrade components and not be visible.
 - c. Toxic gases: Rescuers or workers can be killed in toxic environments.
 - d. Heat or elevated temperatures.
 - e. Moving machinery: Workers or auxiliary equipment can be contacted by or pulled into moving components.
 - f. Sharp edges: Workers or the rescue equipment can be injured by or damaged by sharp edges or components.
 - g. Electrical hazards: Stay away from power lines or components carrying electrical power.
 - h. Overload: Do not exceed rated working load limit during operation.
 - i. Follow confined space regulations in Standards.
 - j. Noise: wear appropriate noise protection where necessary.
 - k. Environmental hazards: do not operate equipment during electrical storms.

3.1 14' PORTABLE FALLARREST POST

3.1.1 General

The **UCL ADVANCED 14' PORTABLE FALL-ARREST POST** is a modular unit consisting of a 3 section tubular body, constructed of welded aluminum, featuring:

1. A head assembly equipped with 1 independent swivel tie-off ring.
2. Various mounting bases to address different situations.
3. Adjusting screws and level indicator for vertical leveling of the Fall-Arrest Post when installed on inclined surfaces.
4. Featuring adjustable height option from 82.0 (2083mm) to 168 (4267mm) inches.

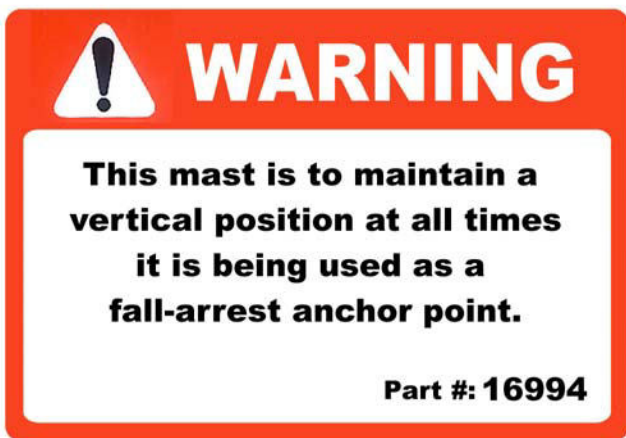
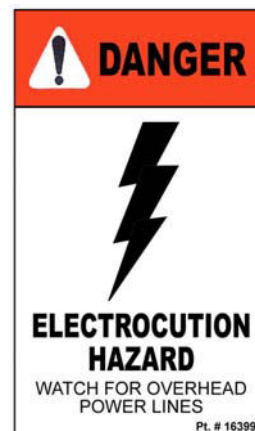

Figure 3.1.1



When using a **UCL ADVANCED 14' PORTABLE FALL-ARREST POST** the rating of any particular system is defined as the rating of the lowest rated component in the system. Check the rating label on each system component before using to ensure that the rating meets all applicable regulatory requirements.

Do not use any equipment on which any of the warning, rating or other labels have been removed, become damaged, or are otherwise illegible. Refer to Section 5 of this manual "Labels", or to the appropriate section of the applicable system manual for information on ordering replacement labels.

3.1.2 Setting Up the Portable Fall Arrest Post

The **UCL ADVANCED 14' PORTABLE FALL-ARREST SYSTEM POST** is designed for use with a variety of portable and permanent mount support bases. Consult the appropriate section of this manual or separate manuals when setting up or installing any UCL Portable Fall Arrest Bases.

Step 1: Before setting up for any work at heights, fall arrest, or confined space entry be sure that you have all equipment required to safely carry out the work to be performed, and to meet all applicable standards and regulations for your area.

Step 2: Set-up or locate the Portable Fall Arrest System Base intended for use in the application according to the instructions in the applicable section of this manual. Ensure that the base is structurally sound and free of any corrosion or contamination which may affect the insertion of the connecting pin or the structural integrity of the base.

Regulations governing Fall Protection, Confined-Space Entry/ Retrieval and Rescue Procedures vary with jurisdiction. It is the responsibility of the owner and/or user of this equipment to be aware of applicable regulations and ensure that equipment selected for each job complies with these requirements.

Refer to the appropriate section of this or any other applicable manuals for specific information on the installation and use of the type of base you are using prior to using the system.

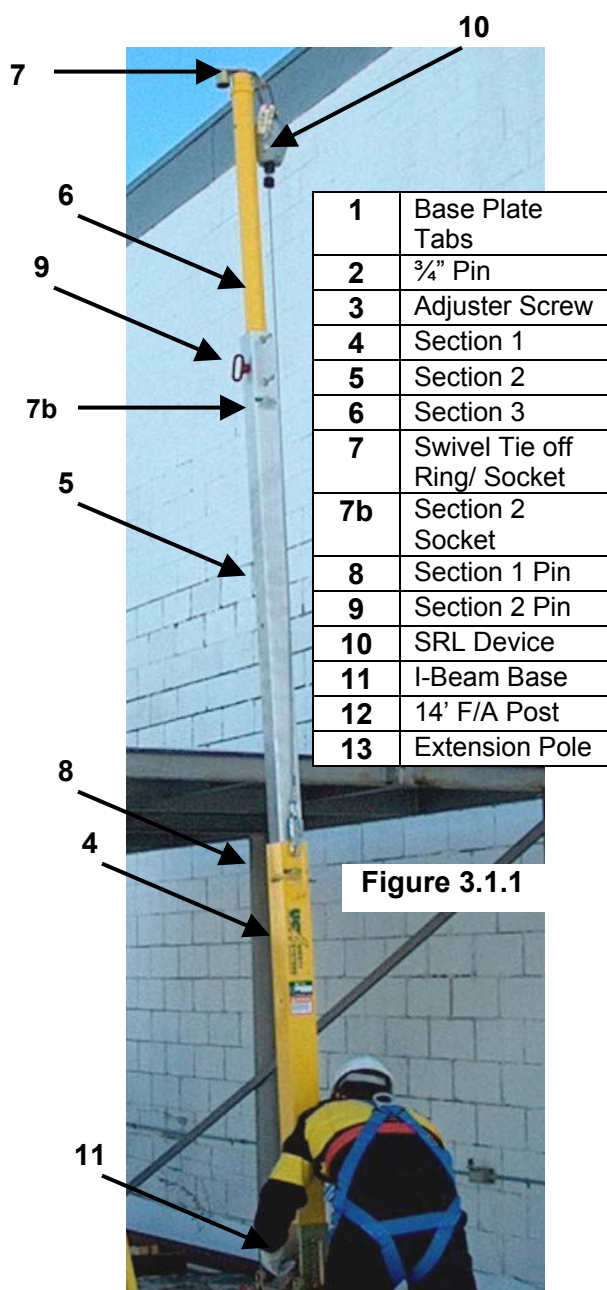

Figure 3.1.1

Step 3: As shown in Fig. 3.1.2, insert the 14' Portable Fall Arrest Post (12) between the base plates tabs (1) and visually align the 3/4" holes as shown in Fig. 3.1.2. Secure the Post by inserting the 3/4" pin (2) through the base plate tabs (1) and sleeve (12). Make sure the pin fully engages both the base plate tabs (1) and the entire post to lock the post firmly in place.

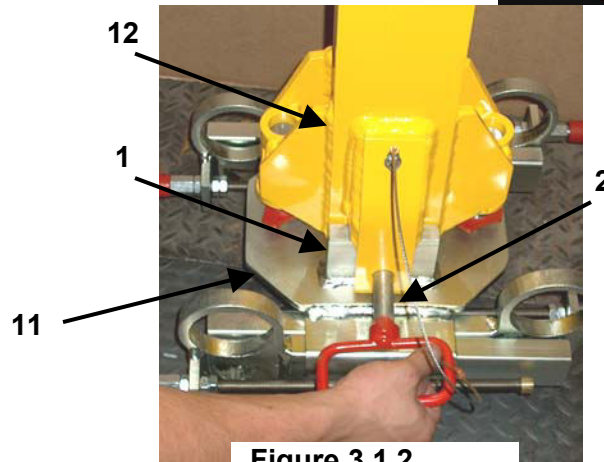

Figure 3.1.2

Step 4: Extend the post by removing the all pin assemblies. Using the extension pole (13), insert the pole into the socket on Section 3 align the holes and secure using pin assembly (9), shown in Figure 3.1.4a & b.

Extend section 2 by inserting the pole into the socket and push up to align the holes and secure using pin assembly (8).

Before extending the post, tag the SRL lifeline snap hook onto the handle of the unit so it is accessible to clip the operator to the SRL prior to climbing a ladder. This post is capable of supporting a variety of heights below 14 feet by adjusting the sections of the post. Adjust the post according to the height of the application that the work is performed.

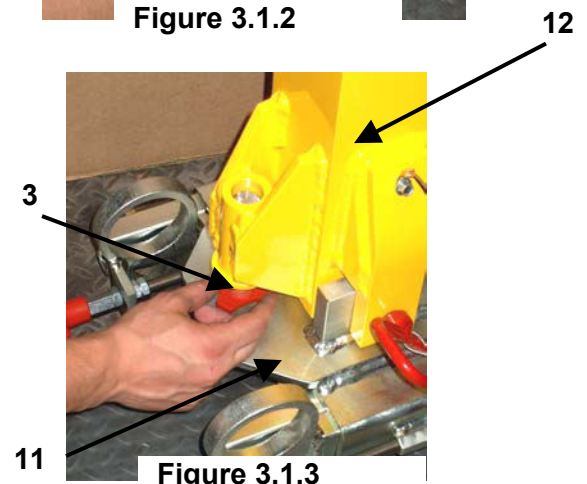

Figure 3.1.3

Step 5: The Portable 14' Fall-Arrest Post (Fig. 3.1.1) must be in a vertical position at all times when it is being used as a Fall-Arrest anchor point. Depending on the type of base you are using the Post may be leveled by using the adjuster screws (3) the base plate (11) or a combination of these, shown in Figure 3.1.3. The adjuster screws are alternately loosened and tightened to level the Post.

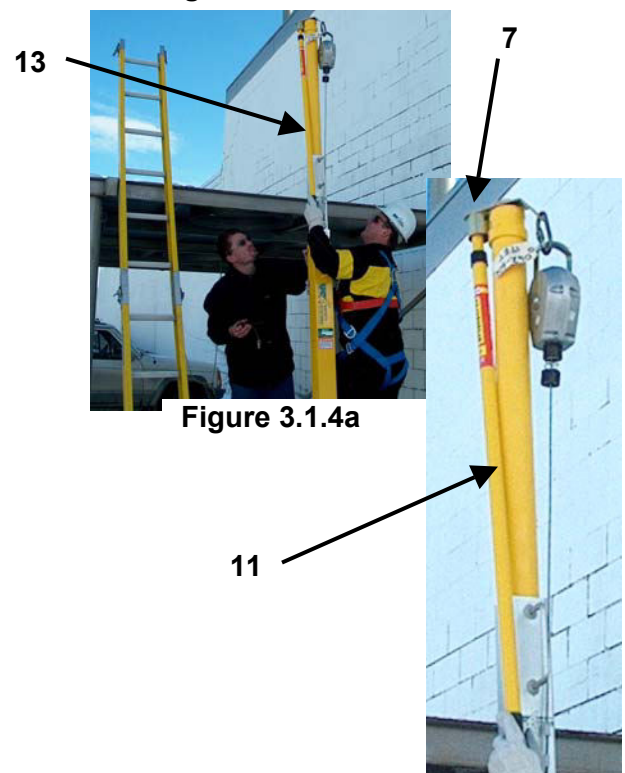

Figure 3.1.4a

Figure 3.1.4b

Step 6: Depending on the nature of the entry and the standards and regulations governing Confined Space Entry/ Retrieval and Rescue requirements in your area, a Personal Fall-Arrest System (PFAS) connected to the entrant may be required. It is the responsibility of the operator to be aware of these requirements and follow them. Always wear a full body harness when attached to a PFAS to minimize potential injury.

Step 7: Once the system is set-up inspect all components, fasteners, and other parts for wear, damage, corrosion, looseness, or any other condition that may reduce the integrity of the system. Components which are worn, damaged, corroded, or loose, must be tagged, marked with "**DO NOT USE**" or like wording and prevented from being used until repaired or replaced as required.

Step 8: Following all instructions contained in the manufacturer's instructions for any PFAS or any other devices being used, the appropriate section of this manual or other manuals for any UCL Accessories being used, and all applicable standards or regulations governing Fall Protection, Confined Space Entry/ Retrieval and Rescue for your area proceed with the work.

3.2 MOUNTING BASES

3.2.1 Weld-on Plates

Weld-on Plates (Pt.# 10816, 16775, 16776, 16777) are designed to be permanently welded to existing structures in locations of frequent work, or where use of portable base is impractical. These mounting plates are compatible with all **UCL ADVANCED PORTABLE FALL-ARREST SYSTEM Posts and Accessories**. Weld-on Plates permanently address Portable Fall-Arrest Anchor Post mounting base requirements for steel structures.



3.2.2 Installing Weld-On Plates

Specific installation instructions are beyond the scope of this product operator's manual. Consult UCL Safety Systems Product Specification Sheet #10816, 16775, 16776, 16777 for detailed information on welding procedures, mounting requirements and application restrictions.

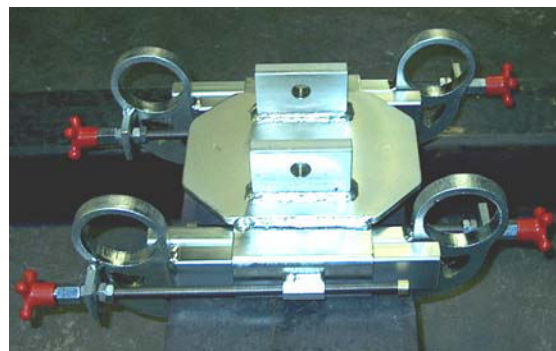

3.2.3 Installing Portable Mounting Bases

Specific installation instructions are beyond the scope of this product operator's manual. Consult UCL Safety Systems Product Specification Sheet # 16997 (I-Beam Clamp Base) or 16804 (Tripod Base) for detailed information on mounting procedures, mounting requirements and application restrictions.

3.2.3 Set-up of the 14' Portable Fall-Arrest Post

Install and level the Portable Fall-Arrest Post as outlined in Section 3.1.2.



WARNING

All anchor points or mounting/set-up locations for permanent or portable systems must be approved to local standards by a qualified engineer and must comply with all mounting requirements and application restrictions as outlined on the applicable UCL Product Specification Sheet. Failure to follow this restriction may result in serious injury or death.

3.3 STORAGE

Prior to storage, the Portable Fall Arrest System should be thoroughly inspected and maintained. Return for repair or replacement of any worn or damaged components to prevent any unnecessary down time at the next use. Follow this procedure:

1. Thoroughly clean the Portable Fall Arrest system using mild soap on the body and labels. Be sure the labels are legible. Refer to Section 5 for information on ordering replacement labels if any are damaged or become illegible.
2. Use a neutralizing solution to clean lifeline. This is particularly important if the unit had been used in corrosive or toxic environments.
3. Perform a complete inspection of the unit and document the results.
4. Touch up all nicks and scratches to prevent corrosion.
5. Store in a cool dry place.

Please contact your local dealer or the manufacturer if your winch requires this modification.

4 MAINTENANCE AND INSPECTION



MAINTENANCE/INSPECTION SAFETY

1. Read, understand and follow the User Manual and signs on the equipment before using, maintaining or inspecting the equipment.
2. ANSI and OSHA requires a regular inspection program for all Confined Space Entry/Retrieval Equipment and to maintain documented results of these inspections. Follow the inspection procedure contained in this of any other applicable the manual and use the inspection form(s) to document the results.
3. Keep instructional and safety labels clean and legible at all times. Clean or replace as required. See Section 5 for label information and part numbers.
4. Lubricate winch as per instructions in Winch Operator's Manual.
5. Remove the equipment from service if a problem is found during the inspection. Return to an authorized repair depot or the factory for service.

4.1 Maintenance

4.1.1 Maintenance Intervals

Daily

1. Visual Inspection

Perform a complete visual inspection. Refer to Section 4.2.1. Remove from service if a defect is found. Refer to Winch Operator's Manual for visual inspection procedure for the UCL Basic winch.

Weekly

1. Functional Inspection

Perform a functional inspection. Refer to Section 4.2.2. Record results and keep documentation.

Annually or As Required

1. Clean Portable Fall Arrest System

Thoroughly clean the Portable Fall Arrest system using mild soap on the body and labels. Be sure the labels are legible. Refer to Section 5 for information on ordering replacement labels if any are damaged or become illegible.

2. Complete Inspection

Perform a complete inspection. Refer to Section 4.2 & 4.3. Record results and keep documentation.

4.2 Inspection

4.2.1 Visual Inspection

A complete visual inspection should be performed on the Portable Fall-Arrest System equipment you are using prior to the operation. The following items should be checked; and the results recorded on the "Inspection Log" sheet (see Section 4.3).

1. Labels

Check that all labels are clean and legible. Clean the labels if any are dirty using a mild soap and a damp cloth. Replace if any are illegible (Refer to Section 5 for a listing of all labels).

2. Fasteners

Check that all screws and other fasteners are tight. If any are loose, tighten as required. Contact your local dealer or UCL manufacturer for any replacement fasteners that may be required

3. Structural Components

Check the components for cracks, dents, bends, or breaks. Minor cosmetic damage in the component body will not affect the function of the Portable Fall-Arrest System. However if there are major dents or any other structural damage, the unit should be removed from service and returned to the manufacturer for service.

4. Corrosion

Check all components for damage from corrosion. Although all components resist corrosion, working in corrosive environments can lead to damage. Inspect all structural components and fasteners for signs of damage. If corrosion damage is found, remove from service and return to the manufacturer for service.

4.2.2 Functional Inspection

A functional check should be performed on the Portable Fall-Arrest System prior to every use. The following functional tests should be done; and the results recorded on the "Inspection Log" sheet (Section 4.3).

1. System Operation and Adjustments

The Portable Fall Arrest System contains operational parts that may include pulleys and /or rollers. These parts must be carefully checked for chips, cracks, or worn areas that can cause malfunction during operation of the system.

Make sure that all the adjustment points are in full functional condition. This may include parts that contain pins, bolts, tri-screws, and adjusting screws. There are also mechanical adjustments which may include, adjustable legs, sleeves, adjustable sliding blocks, and brackets. These areas must be kept clean from debris and corrosion for proper functional use. If any part of the system that includes all listed items above becomes damaged contact your local dealer or manufacturer for parts and/or service.

2. SRL and other Accessory Inspection

Refer to the manufacture's operator's manual or instructional material for proper functional inspection procedures for SRL's and accessories not covered by this manual.

4.3 Inspection Log

Date: _____
 Page _____ of _____

4.3.1 Portable 14 Foot Fall-Arrest Post Inspection Log

Sample Form. Copy page to start inspection log record book. Fill out using ball point pen.

Equipment Identification (Type, Application, Usage & Storage Location)								
Date of Inspection:								
Application of Product:								
Inspector:								
Components (Please write description below)	Serial # if Applicable	Paint & Labels	Fasteners (Secure & Undamaged)	Corrosion & Details	Structural Damage & Details	Corrective Action Taken (if required)	Sign Off	
								netzerotools.com

5 LABELS

5.1 Warning Labels

The **UCL ADVANCED 14' PORTABLE FALL-ARREST POST** uses a label rating system that is attached to all components on the system.

The operator and/or entrant must establish the local standards by a qualified engineer and only then, a decision can be made by the rating labels as to which is the lowest rated component and if it meets or exceeds local standards.

Proper maintenance of the labels must be established by the operator/entrant to keep system use safe. If labels are damaged the operator/entrant must enforce a lock-out/tag-out procedure. New labels are available from the local dealer or UCL manufacturer.

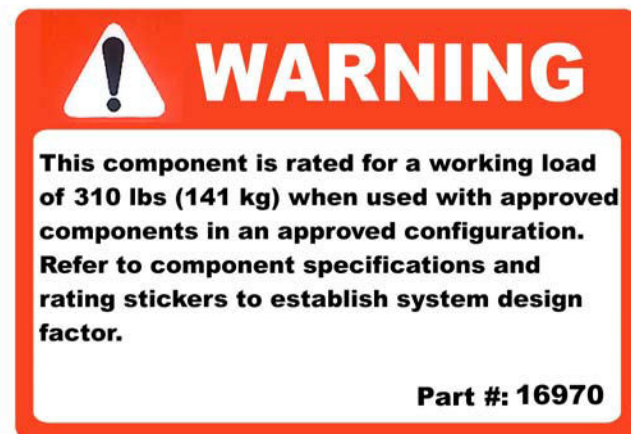
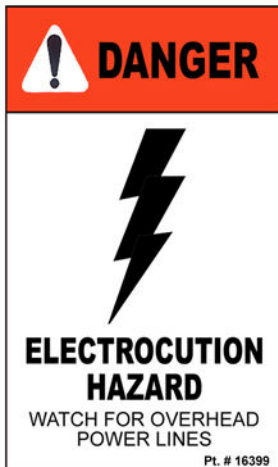

6 SPECIFICATION SHEETS

6.1 General

These specification sheets contain information necessary for the proper installation and use of the equipment mentioned in this manual. These specifications contain application specific ratings and mounting requirements determined through design and testing.

Please read and follow these specification sheets carefully to ensure the proper installation of each item.

14' (4.2 m) Portable Fall Arrest System Post

Model#: 8516996

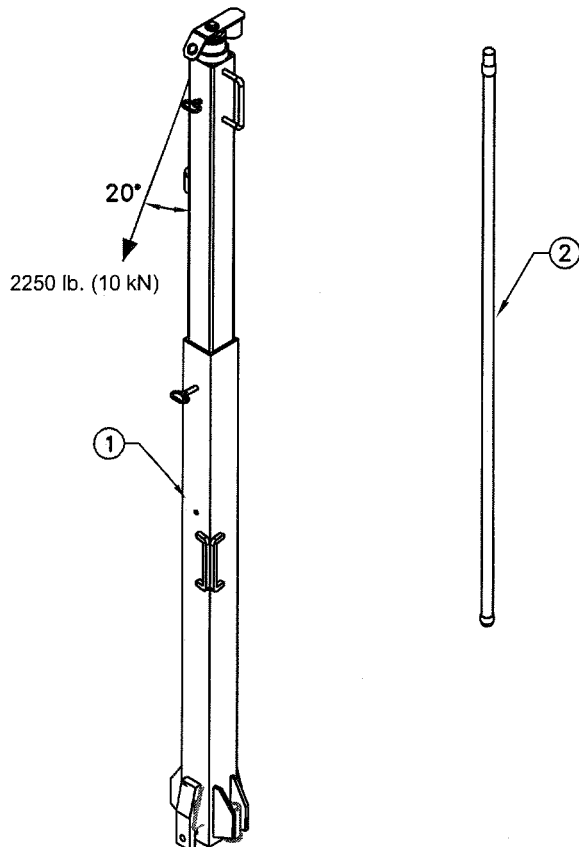

Model 8516996 includes the following

Item	Part no.	Description
1	8516996	14' POST ASSEMBLY
2	n/a	LIFTING POLE

DESCRIPTION

The UCL Safety Systems 14' Portable Fall Arrest Post is designed for use with various mounting systems to provide an overhead fall-protection anchor point to workers. The telescoping is raised from ground level using the lifting pole. Various weld-on plates are available as is a portable I-Beam Base designed to clamp an existing I-beam. The light-weight aluminum structure is powder coated and anodized for corrosion resistance.

General Specifications:

Working Load	310 lbs. (141 Kgs.)
Proof Load	2250 lbs @ 20°
Proof Tests	UCT - 392, 393, 377
Weight	71 lbs. (32.3 kgs)

Materials & Construction:

General Construction	Welded Steel / Aluminum
Weld Certification	CWB-47.1, CWB-47.2
Material (aluminum)	6061-T6 Aluminum
Finish (aluminum)	Powder Coat/Clear Anodize
Material (steel)	H.R. Steel Plate, Sch. 40 Pipe
Finish (steel)	Zinc Plated
Hardware	Gr.5, Gr.8 - Zinc Plated
Plating Specification	ASTM Designation B633-85, Type II, III, SC2

Mounting Requirements(minimum):

Weld-on Plates, I-Beam Mount or Other used to support the Model 16996 14' Post **MUST BE** mounted to a suitable structure, using appropriate fasteners, capable of withstanding the following loads:

- 1) A 130,000 in-lb (14690 N.m) moment.
- 2) A 2250 lb. (1023 Kg) vertical load.

Installation **MUST BE** approved to local regulations by a qualified engineer.

Application Restrictions

1. This device is intended for use with equipment and accessories manufactured and/or approved by Unique Concepts Ltd.
2. Load **MUST BE** applied at an angle not to exceed 20° as shown.
3. **MUST BE** used with a shock absorber or retractable device with an M.A.F. rating of 900 lb. (4 kN) or less.
4. Where required by regulation, each installation **MUST BE** approved to all applicable local standards by a qualified engineer.
5. All equipment **MUST BE** set up and operated under the supervision of a competent person according to the manufacturer's instructions.

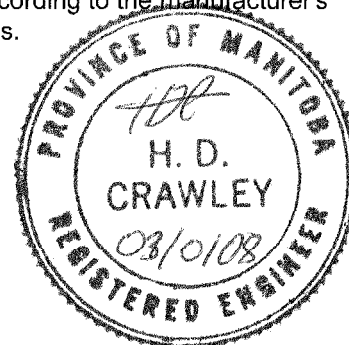

14' (4.2 m) Portable Fall Arrest System Post

Model#: 8516996

SPECIFICATIONS
PAGE 2 OF 2

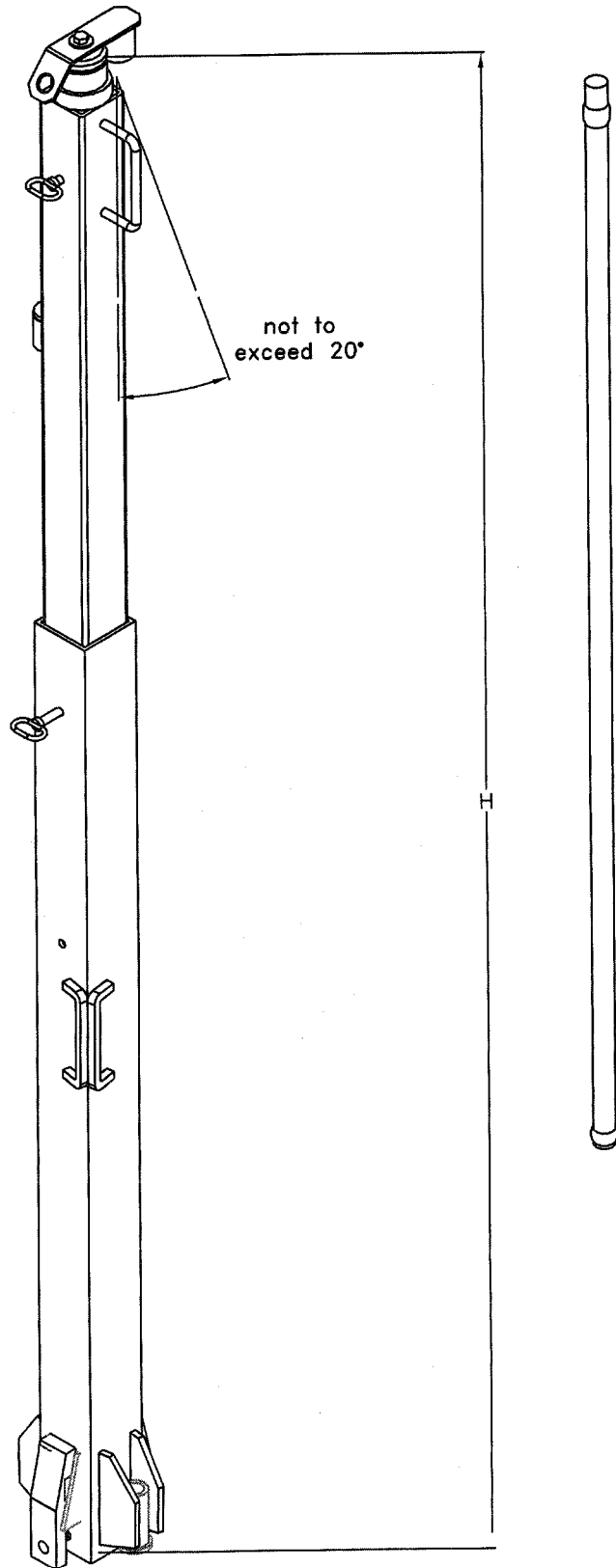

Available System Heights

Position	Height
1	82
2	98
3	116
4	118
5	132
6	134
7	152
8	168

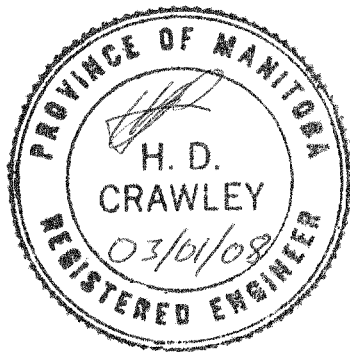

ISO 9001
REGISTERED

