

IND-MISPAFCMB4235

Bluetooth/CD/MP3/USB PLAYER WITH FM/AM TUNER

OPERATING INSTRUCTION

Safety Information

Thank you for purchasing this product. Please read through these operating instructions so you will know how to operate your model properly. After you have finished reading the instructions, keep this manual in a safe place for future reference.

PRECAUTIONS

- Use only in a 12-volt DC negative-ground electrical system.
- Disconnect the vehicle's negative battery terminal while mounting and connecting the unit.
- When replacing the fuse, be sure to use one with an identical amperage rating. Using a fuse with a higher amperage rating may cause serious damage to the unit.
- DO NOT attempt to disassemble the unit. Laser beams from the optical pickup are dangerous to the eyes.
- Make sure those pins or other objects do not get inside the unit, they may cause malfunctions, or create safety hazards such as electrical shock or laser beam exposure.
- If you have parked the car for a long time in hot or cold weather, wait until the temperature in the car become normal before operating the unit.
- Keep the volume at a level at which you can hear outside warning sounds (horns sirens, etc.).
- Stop the car before performing any complicated operation.

CD NOTES

- Playing a defective or dusty CD can cause dropouts in sound.
 - Handle the disc by holding its inner and outer edges. Do not touch the surface of the unlabeled side of the disc.
 - Do not touch the unlabeled side.
 - Do not attach any seal, label or data protection sheet to either side of a disc.
 - Do not expose a CD to direct sunlight or excessive heat.
 - Wipe a dirty CD from the center outward with a cleaning cloth.
 - Never use solvents such as benzine or alcohol.
 - This unit can not play 3-inch (8cm) CDs. Never insert a 3-inch CD contained in the adapter or an irregularly shaped CD. The unit may not be able to eject it, resulting in a malfunction.
- ★In addition to ordinary CDs, this unit can play back a CD-R/CD-RW/MP3/UDF/CD-TEXT.
-

CAUTION

Please power off this unit at once and send it back to the after-sales service center or the dealer /distributor you purchased from if one of the following symptoms is found:

- (1) Water or other obstacle enters the unit;
- (2) Smoking;
- (3) Peculiar smell.

Contents

Safety Information	2
Panel Controls	3
Remote Controls.....	4
General Operation	5
CD Player Operation	6
Tuner Operation	7
Playing MP3/WMA Files	7-8
USB MP3 Playback	8
Bluetooth Operation.....	9-10
System Menu.....	11
Electrical Connections	12
Installation Guide.....	13
Troubleshooting.....	14
Specifications	15

To provide a clear demonstration and an alternative for easy understanding of the operation of this unit, graphic illustration was used. However, this illustration is not necessary printed as the actual image found on the unit.

Panel Controls

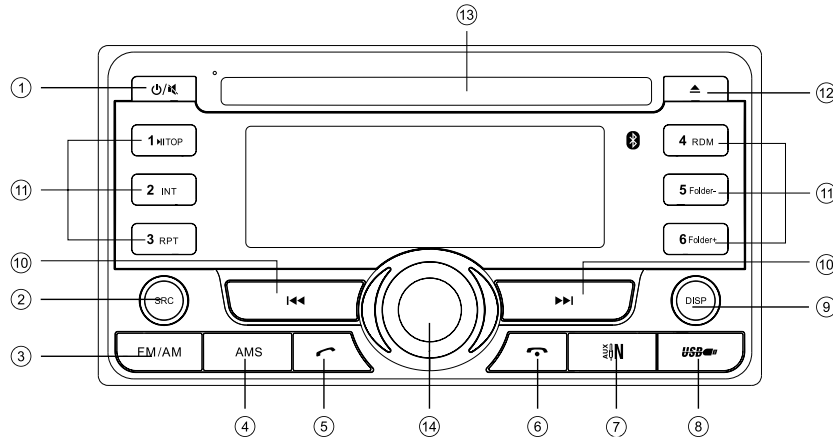

1. - Power on
 - Mute
 - Power off(long press)
2. - Radio
 - Disc (when disc is in)
 - USB (when USB connected)
 - AUX in
 - BT Music (when bluetooth connected)
3. - Band select
4. - Radio mode, scan preset stations, long press to search and store strongest stations in the memory automatically.
 - MP3 search
5. - Answer phone
 - Dial number

6. - Terminate call
7. - Aux-in jack
8. - USB connector
9. - Display switch
10. - SEEK mode
11. - Disc playback
 - Button 1: - Play/pause
 - Start play from the beginning of the first track.(long press)
 - Button 2: - Intro play (10 sec.)
 - Button 3: - Track repeat play
 - Button 4: - Track random play
 - Button 5: - MP3 folder down
 - MP3 track -10 down (long press)

- Button 6: - MP3 folder up
 - MP3 track +10 up (long press)
 - 1-6 Preset:
 - Press to tune in a preset station.
 - Long press to store station.
12. - Disc eject
13. - Disc slot
14. - Rotate to adjust volume
 - Push to select VOL/BAS/TRE/BAL/FAD, rotate the knob to adjust level.
 - Press more than 2 seconds to enter menu mode.

Remote Controls

Operating range

Point the remote control unit to the remote sensor when you operate with it.
The remote control can operate within a distance of 3-5m.

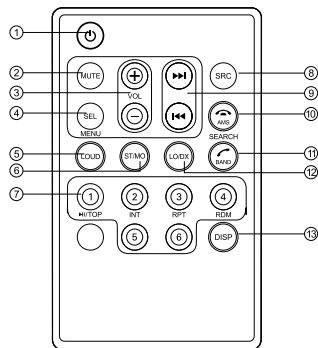
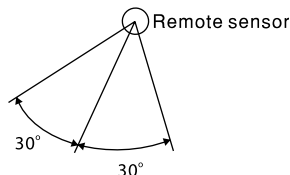

1. - Power on/off
2. - Mute
3. - Volume
4. - Press to select VOLUME/BASS/TREBLE/BALANCE/FADER, use volume button to adjust level.
- Press for more than 2 seconds to menu function.

5. - Loudness
6. - FM stereo/mono
7. - CD playback
 - Button 1: Press briefly for Play/Pause function. Press for more than 2 seconds if you want to start playback from the beginning of the first track of your disc.
 - Button 2: Intro play (10 sec.)
 - Button 3: Track repeat play
 - Button 4: Track random play
 - Button 5: - Previous folder
 - MP3 track -10 down (long press)
 - Button 6: - Next folder
 - MP3 track +10 up (long press)
- 1-6 Button: Radio preset
Press to listen to a preset station.
Hold more than 2 seconds to store station.
8. - Radio
 - Disc play (when disc inserted)
 - USB (when USB inserted)
 - AUX-in
9. - Radio tune
 - To fast search within a track/skip to next or previous track
- 10.- AMS
 - Radio auto preset/Radio preset scan
 - MP3 track/file/character search
 - Call off / cancel
- 11.- Band switch:
 - FM1->FM2->FM3->AM1->AM2
 - Dial/Receive call
- 12.- Radio local/distant
- 13.- Display switch

Replacing the lithium battery of remote control unit.

When the operation range of the card remote control becomes short or no properly, replace the lithium battery with a new one. Make sure the battery polarity replacement is correct.

1. Pull out the battery holder while pressing the stopper.
2. Insert the button-type lithium battery with the (+) mark facing upward. Insert the battery holder into the remote control.

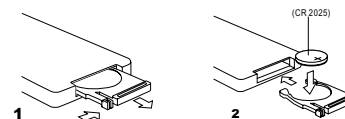

WARNING:

- Store the battery where children cannot reach. If a child accidentally swallows the battery, consult a doctor immediately.
- Do not recharge, short, disassemble or heat the battery or dispose it in a fire. Otherwise, the battery may start to give off heat, crack or catch fire.
- Do not leave the battery with other metallic materials. Otherwise, the battery may start to give off heat, crack or catch fire.
- When throwing away or saving the battery, wrap it in tape and insulate. Otherwise, the battery may start to give off heat, crack or catch fire.

General Operation

Power On/Off Button

Press the  button to turn the unit on when the vehicle ignition switch is on. Press and hold the button to turn the unit off.



Mode Button (SRC)

Press the SRC button to change between Radio, DISC (when disc is in), USB (when USB is connected), AUX play or BT (Music (when bluetooth connected)).

Adjust Volume level

Rotate the knob to adjust volume level. Rotate it clockwise to increase and anticlockwise to decrease the volume.

Audio Mute

Press the  button to mute the volume from the system. "MUTE" will appear on the display panel and the volume will be muted. Press the  button again, or rotate or press the knob to return the volume level to the setting in use before the Mute function was activated.

Audio Controls

To adjust the bass, treble, balance and fader, press the knob repeatedly until the appropriate audio control appears on the display panel. Within five seconds, rotate the knob to adjust the audio settings for the selected function.

Auxiliary Input

To access an auxiliary device:

1. Connect the portable audio player to the AUX interface on the front panel of the unit.
2. Press the SRC button to select Aux-In mode.

Press SRC again to cancel Aux-In mode and go to the next mode.

Display Selector (DISP)

Press DISP (once for Radio mode or twice for other modes), display shows the clock time for 5 seconds.

Press DISP, time displays. Press again for more than 2 seconds, time display blinks. Rotate the knob to set clock, press DISP again to exit the clock setting.

CD Player Operation

Inserting a Disc

With the label surface facing up, fully insert a compact disc into the disc slot until the mechanism engages and pulls the disc in. Play will automatically begin from the first track on the disc.

NOTE: The unit is designed for play of standard 5" (12 cm.) compact discs only. Do not attempt to use 3" (8 cm.) CD singles in this unit, either with or without an adaptor, as damage to the player and/or the disc may occur.

Disc Eject Button

Press the eject button to stop disc play and eject the disc. The unit will revert to radio operation. Discs may be ejected with the vehicle ignition switch on. If an ejected disc is not removed from the disc slot within 10 seconds of being ejected, the disc will be re-inserted automatically.

NOTE: To prevent a disc from accidentally being damaged, always remove the disc from the unit when disc play is finished.

CD Play/Pause Selector

Press the 1 >|| button to freeze disc playback. Press 1 >|| again to resume disc playback.

Seek Up/Next Track

Press the next track >>| button during disc play to select the beginning of the next track.

Seek Down/Previous Track

Press the previous track |<< button during disc play to select the beginning of the current track.

Cue/Review Functions

High-speed audible search to any section of the disc can be made by the Cue and Review functions. Press and hold the next track >>| button to advance rapidly in the forward direction or the previous track |<< button to advance rapidly in the backward direction.

Scan Play Selector

During disc play, press the 2/SCAN button to select "SCAN ON" and play the first 10 seconds of each track. When a desired track is reached, press the 2/SCAN button to select "SCAN OFF" and play the current track.

Track Repeat Play Select

During disc play, press the RPT button (9) to select "RPT ON" and repeatedly play the selected track. Press RPT again to select "RPT FOLD" and repeatedly play all tracks in the current folder. Repeat play will continue until RPT is pressed to select "RPT OFF".

Random Play Select

During disc play, press the 4/RDM button to select "RDM ON" and play all tracks on the disc in random, shuffled order. Press RDM again to select "RDM OFF" and cancel Random Play mode.

Tuner Operation

FM/AM Band

During radio play, press the FM/AM button to choose between three FM and two AM bands. The indication “AM” or “FM” appears on the display panel according to your selection.

Up Tuning

Press the seek up >>| button to tune stations upward step-by-step. The current frequency will be shown in digital format on the display panel.

Press and hold the seek >>| button to the next available station.

Down Tuning

Press the seek down |<< button to tune stations downward step-by-step. Press and hold the seek down |<< button to the previous available station.

Auto Memory Store

Press the AMS button to scan preset stations 1-6. Hold it to automatically select six strong stations and store them in the current band. The new stations replace stations already stored in that band.

Playing MP3/WMA Files

Display Information

During playback, ID3 tag information display scrolling on the screen: FOLDER, FILE, ALBUM, TITLE, ARTIST and Track Number/Elapsed Time.

Folder Up/Down

Press the 5/Folder- button to go to the previous folder. Press the 6/Folder+ button to go to the next folder.

Direct Song/File Access

1. Press the AMS button once and press the knob to enable direct track searching.
2. Rotate the knob to select a digit at the units position.
3. Press the knob to confirm entry and the tens digit will flash.
4. Rotate the knob to select the tens digit.
5. Repeat above steps to enter the hundreds and thousands digit, if necessary.
NOTE: The unit will only allow the selection of digits that correspond with the number of files on the media you are searching.
6. Once the track number appears on the screen, press the knob to play the selected song/file.

Searching Folders/Files

1. Press the AMS button twice and press the knob to access the “FILE SCH” option.
2. Rotate the knob to select the desired directory/song.
3. Press the knob to view the files inside the selected directory.
4. Rotate the knob to select the song/file. Press the knob to play the selected song/file.

Playing MP3/WMA Files

MP3 Overview

- MP3 is short for MPEG Audio Layer 3 and refers to an audio compression technology standard.
- This product allows playback of MP3 files on CD-R or CD-RW discs.
- The unit can read MP3 files written in the format compliant with ISO 9660. However it does not support the MP3 data written by the method of packet write.
- The unit can not read an MP3 file that has a file extension other than ".mp3".
- If you play a non-MP3 file that has the ".mp3" extension, you may hear some noise.
- In this manual, we refer to what are called "MP3 file" and "folder" in PC terminology as "Track" and "Album", respectively.
- Maximum number of directory level is 8, including the root directory. Maximum number of files and folders per disc is 256.
- The unit may not play tracks in the order of track numbers.
- The unit plays only the audio tracks if a disc contains both audio tracks and MP3 files.
- When playing a disc of 8kbps or VBR*, the elapsed playing time in the display window will not be correct and also the scan play may not function properly.
*VBR: Variable Bit Rate.

Note on creating your own CD-Rs or CD-RWs containing MP3 files

- To enjoy high quality sound, we recommend converting to MP3 files with a sampling frequency of 44.1 kHz and a fixed bit rate of 128 kbps.
- DO NOT store more than 256 MP3 files per disc.
- For ISO 9660-compliant format, the maximum allowable depth of nested folders is 8, including the root directory(folder).
- When CD-R disc is used, playback is possible only for discs which have been finalized.
- Make sure that when MP3 CD-R is burned that it is formatted as a data disc and NOT as an audio disc.
- You should not write non-MP3 files or unneeded folders along with MP3 files on the CD-R otherwise it takes a long time until the unit starts to play MP3 files.
- With some CD-R media, data may not be properly written depending on their manufacturing quality. In this case, data may not be reproduced correctly. High quality CD-R disc is recommended.
- Up to 16 characters are displayed for the name of an Album or a Track. ID3 TAG version 1.x is required.
- Note that the unit may not play tracks in the order that you wrote them to the disc.

USB MP3 Playback

1. Loading USB equipment
Insert the USB into the connector and the unit play the music in the USB storer automatically and the LCD will show USB-DRIV.
2. Take out USB equipment
Push the SRC button and switch to non USB-DRIV mode, then take off the USB storer, push up the cap.

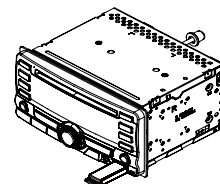

USB Notes

USB functions (flash memory type) MP3 music play

- (1) USB flash memory 2 in 1 support
- (2) Fat 12 / fat 16 / fat 32 is possible
- (3) File name : 32 byte / dir name : 32 byte / tag name : 32 byte
- (4) Tag (ID3 tag ver 2.0)
- title / artist / album : 32 byte support
- (5) USB 1.1 support
USB 2.0 support (It can not support USB 2.0 speed. Just, get be same speed with USB1.1)
- (6) Not all kinds of USB devices are compatible with the unit.

Bluetooth Operation

Note:

For your safety, avoid talking on the phone as much as possible while driving.

Bluetooth is a wireless transmission way for short distance. The built-in Bluetooth can connect with the mobile phones having Bluetooth function.

After connecting, you can control your mobile phone through the unit.

Pairing

Use this function to establish a connection between the unit and your mobile phone.

1. Turn on the unit.
2. Turn on Bluetooth function of your mobile phone, keep phone within 3 meters to the unit and start to search for Bluetooth devices.
3. After the name of the Bluetooth module "xxxx" appears on the pairing list of your mobile phone, select it. At this time, a pairing code is required. Enter the pairing code "1234", and the Bluetooth pairing will process automatically. Some mobile phones may instruct you to select connect or disconnect, please select connecting.



Exit Pair

After pair successfully, if you want to disconnect, press and hold  button to disconnect Bluetooth connection.

Make a call



1. Press SRC button to select BT MUSIC mode.
2. Press  button.
3. Rotate the knob to select from the following list:
DIAL NUM: dial number directly
DIALLED: dialed number
MISSED: missed call
RECEIVED: received call
ME PBK: Phone directory
SIM PBK: SIM directory
4. Press the knob to confirm the selection.

To dial a number directly, select DIAL NUM.

1. Rotate and press the knob to select phone number.
 - Press  button to delete a digit inputted.
 - Press  button to reset entered number.
2. Press  to dial out.

To use a number in call log or directory, select the option other than DIAL NUM.

Receive

1. After pair successfully, if there is a call incoming, the unit switch to BT mode automatically.
2. Press  button to receive.
3. Press  button to hang up.

Call Transfer

During talking, press  button to transfer audio from the unit to your mobile phone.

Note:

Some mobile phones will transfer audio from the unit to themselves once the incoming call is answered.

BT Audio

To listen to audio from a bluetooth device and control playback with the unit.

1. Press SRC button repeatedly to select BT MUSIC mode.
2. To play or pause, press 1 >|| TOP.

Bluetooth Operation

Music Mode

A2DP

A2DP is short for Advanced Audio Distribution Profile. The mobile phones supporting this function can transmit stereo audio, whereas the ones not supporting this function can transmit mono audio only.

General Notes for Bluetooth

1. For some types of mobile phones, during our test, after the mobile phones appear connection successful, the unit still appear waiting for pairing. At this time you must find the unit's Bluetooth module name "xxxx" on the pairing list on your mobile phone and select connecting in the submenu, then the unit will appear CONNECT. Otherwise, there is no voice coming out when communicating, though the mobile phone has already displayed CONNECT. Some mobile phones, when it play back A2DP, you must find the unit name in the phone's menu and reconnect (check your mobile phone whether has the A2DP & AVRCP functions).
2. When pairing, some types of mobile phone hint that how to operate, for example, when you make a phone call by the unit, if the mobile phone voice doesn't be transferred to the unit, no voice comes out.
3. Depending on the mobile phone, if private mode is selected, when you make a phone call by the unit, or receive, the voice would be transferred to the mobile phone. But sometime the Bluetooth maybe disconnect till the communication ends, then connects your mobile phone to the unit automatically. Some mobile phones maybe need pair again.
4. For mobile phone, the Bluetooth device name must be primary symbols or numbers. Otherwise, some unpredictable issues may occur during the Bluetooth devices connecting and making phone call.
5. After CONNECT, if no sound produced, please check whether the Bluetooth stereo audio on the phone switched ON.

System Menu

Press and hold the knob more than 2 seconds to enter menu mode , then each press changes the mode as follows:

DSP mode:

Rotate the knob to choose DSP sound effect:
POP->ROCK->CLASSIC->JAZZ->DSP OFF

LOUD mode

When listening to music at low volumes, this feature will boost the bass and treble ranges to compensate for the characteristics of human hearing.

BEEP ON/OFF

Rotate the knob to choose button beep sound on or off.

DIM 1/2/3

To select Dimmer, connect the Light wire to your car. Rotate the knob to select the brightness of LCD.

STEREO/MONO mode

Rotate the knob to choose FM stereo or mono.

LOCAL/DX

Rotate the knob to choose radio local or distant.

LOCAL: Only stations with strong signal can be broadcast.

DX: Stations with strong and weak signals can be broadcast.

ROLL ON/OFF

Rotate the knob to choose ROLL ON or OFF. When ROLL is ON, the LCD will display ID3 TAG information cyclely.

When ROLL is OFF, the LCD will display one of the ID3 TAG information, but user can adjust it to other ID3 TAG information by press [BAND] button.

VOL LAST/ADJ mode

Rotate the knob to choose VOL LAST mode, the turn on volume level is the volume level of latest power off.

Rotate the knob to choose VOL ADJUST mode, press to enter A-VOL mode, then rotate the knob to set the turn on volume level.

12/24 HOUR mode

Rotate the knob to select 12 or 24 HOUR time format.

AUTO ON/OFF mode (BT mode)

Rotate the VOL/MENU knob to choose AUTO CONNECT on or off.

* The factory default setting is "ON".

Electrical Connections

Wiring Diagram

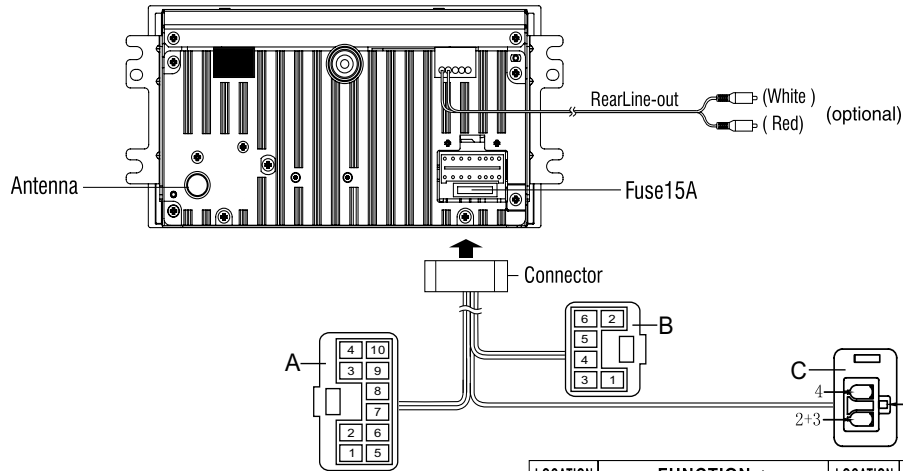

LOCATION	FUNCTION A	LOCATION	FUNCTION B
1	Front Right (+)/grey	1	Rear Right (+)/purple
2	Front Left (+)/white	2	Rear Left (+)/green
3	ACC+/red	3	Rear Right (-)/purple and black
4	Battery(+)/yellow	4	
5	Front Right (-)/grey and black	5	
6	Front Left (-)/white and black	6	Rear Left (-)/green and black
7	GND/black	LOCATION	FUNCTION C
8		1	AutoAntenna/blue
9		2+3	Antenna/black
10	Light/orange	4	

Installation Guide

Installation Opening

This unit can be installed in any dashboard having an opening as shown below. The dashboard should be 4.75mm - 5.56mm thick in order to be able to support the unit.

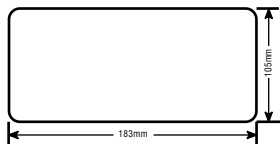

If the opening is too small, carefully cut or file as necessary until the unit easily slides into the opening. Do not force the unit into the opening or cause it to bend or bow. Check for sufficient space behind the dashboard for the unit chassis.

Reset

Press the RESET button with a pointed object to reset the unit to the original status.

Note: Press the RESET button will erase the clock setting and stored stations.

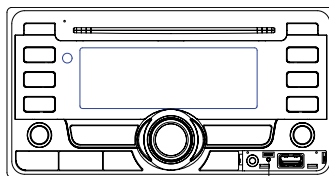

Reset

Installation Procedures

1. If relevant, remove any other audio system from the car.
 2. Fastening the bolt and rubber cushion.
 3. Perform the required electrical connections.
 4. Then check that everything works before installing the main unit.
 5. Remove the two screws on the top of the unit, otherwise, the unit will not work.
- * If you are not sure how to install this unit correctly, contact a qualified technician.

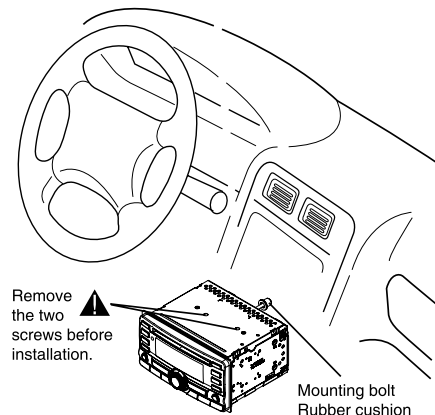

Troubleshooting

The following checklist can help you solve some problems which you may encounter when using the unit. Before consulting it, check the connections and follow the instructions in the user manual. Do not use the unit in abnormal condition, for example without sound, or with smoke or foul smell can cause fire or electric shock, immediately stop using it and call the store where you purchased it.

Problem	Possible cause	Solution
General		
The unit will not switch on.	Car ignition is not on. Cable is not properly connected. Fuse is burnt.	Turn your car key in the ignition. Check cable connection. Replace fuse with a new fuse of the same capacity.
No sound	Volume is set at minimum or the mute function is on.	Check the volume or switch the mute function off.
The unit or screen does not work normally.	The unit system is unstable.	Press the RESET button.
DISC mode		
The appliance will not play discs.	The disc is inserted incorrectly. The disc is dirty or damaged.	Disc must be inserted with the label side facing up. Clean the disc and check for damage. Try another disc.
Sound skips due to vibration.	Mounting angle is over 30°. Mounting is unstable.	Adjust mounting angle to less than 30°. Mount the unit securely with the supplied parts.
TUNER mode		
Unable to receive stations.	The antenna is not connected properly.	Connect the antenna properly.
Poor quality reception of radio station.	The antenna is not fully extended or it is broken.	Fully extend the antenna and if broken, replace it with a new one.
Preset stations are lost.	The battery cable is not properly connected.	Connect the permanent live on the unit to the permanent live on the vehicle.
USB mode		
Unable to insert USB device.	The USB device has been inserted the wrong way round.	Insert it the other way around.
The USB device cannot be read.	NTFS format is not supported.	Check that the file system is in FAT or FAT32 format. Due to different formats, some models of storage devices or MP3 players may not be read.

Specification

General	
Power supply:	12V DC (11V-16V) Test voltage 14.4V, negative ground
Maximum power output:	45Wx4 channels
Continuous power output:	25Wx4 channels (4Ω,10% T.H.D.)
Suitable speaker impedance:	4-8 ohm
Pre-Amp output voltage:	2.0V (CD play mode: 1KHz, 0 dB, 10 KΩ load)
Fuse:	15A
Dimensions(WxHxD):	181x104x168mm
Weight:	1.96kg

FM Stereo Radio	
Frequency range:	87.5-108.0MHz
Usable sensitivity:	8dBμ
Quieting sensitivity(S/N=50dB):	12dBμ
Frequency response:	30Hz-15kHz
Stereo separation:	30dB (1kHz)
Image response ratio:	50dB
IF response ratio:	70dB
Signal/noise ratio:	55dB

MW(AM) Radio	
Frequency range:	522-1620KHz
Usable sensitivity(S/N=20dB):	30dBμ

Disc Player	
System:	Disc digital audio system
Frequency response:	20Hz-20kHz
Signal/noise ratio:	>80dB
Total harmonic distortion:	Less than 0.20% (1kHz)
Wow and flutter:	Below measurable limits
Channel separation:	>55dB

Components	
Mounting bolt (50mm)	1
Mounting collar	1
Wire connector	1
Operating instructions	1
Remote control unit	1
Rubber cushion	1

Note: Specifications and the design are subject to change without notice due to improvements in technology.

