



# **NURIT 8000 Secure**

**Quick Service Payment  
Functionality**

**User Guide**

**APPLICATION  
POS\_STD  
POS\_PLUS  
VERSION 4\_82**

**Wireless  
Palmtop  
Solution**



## Product Regulatory Information

---

### FCC PART 15 REQUIREMENTS

This equipment has been tested and found to comply with the limits for Class B digital device, pursuant to Part 15 of the FCC Rules. These limits are designed to provide reasonable protection against harmful interference in a residential installation.

This equipment generates, uses and can radiate radio frequency energy and, if not installed and used in accordance with the instructions, may cause harmful interference to radio communications. However, there is no guarantee that interference will not occur in a particular installation.

If this equipment does cause harmful interference to radio or television reception, which can be determined by turning the equipment off and on, the user is encouraged to try to correct the interference by one or more of the following measures:

- Reorient or relocate the receiving antenna.
- Increase the separation between the equipment and the receiver.
- Connect the equipment into an outlet on a circuit different from that to which the receiver is connected.
- Consult your dealer or an experienced technician for help.

Connection of peripherals to this unit requires the use of grounded, shielded cables to ensure compliance with the class B limits.

---

### FCC PART 68 REQUIREMENTS

[APPLICABLE WHEN  
USING OPTIONAL  
NURIT 8000  
SECURE DOCKING  
STATION OR NURIT  
8000 EXTERNAL  
MODEM]

The Federal Communications Commission (FCC) has established rules permitting this device to be directly connected to the telephone network. Standardized FCC Part 68 compliant telephone line cords and modular jacks are used for these connections. This equipment **should not** be used on party or coin lines.

If this device is malfunctioning, it may be causing harm to the telephone network; this device should be disconnected until the source of the problem can be determined and until repair has been made. If this is not done, the telephone company may temporarily disconnect service.

The telephone company may make changes in its technical operations and procedures; if such changes affect the compatibility or use of this device, the telephone company is required to give adequate notice of the changes. You will be advised to file a complaint with the FCC.

If the telephone company requests information on what equipment is connected to their lines, inform them of:

- The telephone number this unit is connected to
- The ringer equivalence number: 0.2A
- The USOC jack required: RJ-11C
- The FCC Registration number:

*The Ringer Equivalence Number (REN) is used to determine how many devices can be connected to your telephone line. In most areas, the sum of the RENs of all devices on any one line should not exceed five (5). If too many devices are attached, they may not ring properly. To be certain of the number of devices that may be connected to the line, as determined by the total RENs, contact the telephone company to determine the maximum REN for the calling area.*

---

Continued on next page

## Product Regulatory Information, Continued

---

### FCC PART 90 REQUIREMENTS

This device contains a radio transceiver module, (FCC ID number is located on the bottom of the terminal), operating under Part 90 of the FCC rules in a licensed part of the radio spectrum. Qualified personnel must perform service or repairs to the radio portion of this device. Any unauthorized modification to the radio module, shielding, or antenna system may void the user's authority to operate this device

---

### IN CANADA

This digital apparatus does not exceed the class B limits for radio noise emissions from digital apparatuses set forth in the Radio Interference Regulations of the Canadian Department of Communications.

Le présent appareil numérique n'émet pas de bruits radioélectriques dépassant les limites applicables aux appareils numériques de la classe B prescrites dans le Règlement sur le brouillage radioélectrique édicté par le ministère de Communications du Canada.

---

### SHIPPING

Carefully pack and send the package prepaid, adequately insured and preferably in the original carton. Attach a postage-paid letter to the outside of the package detailing the complaint.

***PLEASE NOTE: SHIPMENT MUST BE SENT TO AN AUTHORIZED DEALER OR SERVICE CENTER ONLY. PLEASE NOTIFY YOUR LIPMAN REPRESENTATIVE BEFORE SHIPMENT. PRODUCTS SENT TO OTHER LOCATIONS WILL BE RETURNED AT OWNERS EXPENSE. CONTACT YOUR DEALER FOR THE CORRECT ADDRESS.***

---

## LIPMAN USA - NURIT 8000 SECURE - Limited Warranty

**Lipman USA Inc.** will repair this product with new or rebuilt parts, free of charge, in the U.S.A. for one (1) year from the date of original purchase in the event of a defect in materials or workmanship. Carry-in or mail-in service in the continental U.S.A. can be obtained during the warranty period from our N.Y. Service Center or call 1-800-4-LIPMAN toll free. In New York State call (516) 484-9898.

This warranty is extended only to the original purchaser. A purchase receipt or other proof of date of original purchase will be required in order to exercise your rights under this warranty.

This warranty only covers failures due to defects in materials or workmanship which occur during normal use. It does **not** cover damage which occurs in shipment; failures which are caused by products not supplied by Lipman USA; or failures which result from accident, misuse, abuse, neglect, mishandling, misapplication, alteration or modification; service by anyone other than the Lipman USA Service Center or accredited service centers, or damage that is attributable to acts of God.

### Limits and Exclusions

There are no express warranties except as listed above.

LIPMAN USA SHALL NOT BE LIABLE FOR INCIDENTAL OR CONSEQUENTIAL DAMAGES RESULTING FROM THE USE OF THIS PRODUCT, OR ARISING OUT OF ANY BREACH OF THIS WARRANTY. ALL EXPRESSED AND IMPLIED WARRANTIES, INCLUDING THE WARRANTIES OF MERCHANTABILITY AND FITNESS FOR A PARTICULAR PURPOSE, ARE LIMITED TO THE APPLICABLE WARRANTY PERIOD SET FORTH ABOVE.

Some states do not allow the exclusion or limitation of incidental or consequential damages, or limitations on how long an implied warranty lasts, therefore some of the above exclusions or limitations may not apply to you.

This warranty gives you specific legal rights and you may also have other rights which vary from state to state.

If a problem with this product develops during or after the warranty period, you may contact your dealer or Service Center. If the problem is not handled to your satisfaction, then write to:

LIPMAN USA INC., 50 Gordon Drive, Syosset, N.Y. 11791

E-mail: [NURITsys@lipmanusa.com](mailto:NURITsys@lipmanusa.com)

Tel: (516)-484-9898 FAX: (516)-484-9057.

## General and Safety Instructions

---

### SECTION DESCRIPTION

When using this NURIT Wireless POS EDC Terminal or any equipment or accessories associated with it operation, basic safety precautions as below should always be followed to reduce the risk of fire, electric shock, or personal injury.

The following safety instructions are based in general on those provided by Underwriters Laboratories Inc. U.S.A.

---

1. Read **and** understand **all instructions**.
2. **Follow** all warnings and instructions marked on the unit.
3. **Unplug** the unit from wall outlets before cleaning. **Do not** use liquid or aerosol cleaners. Use a damp cloth for cleaning and/or a soft brush.
4. **Do not** use the unit near water when using the AC charger or external modem.  
  
Place the unit on a stable surface when operated in a fixed location. When operated hand-held, be sure to grasp the unit securely. **Serious damage** may result if the unit falls.
6. **Do not** cover slots and openings of the unit. They are provided for ventilation and protection against overheating. Never place the unit near radiators, or in a place where proper ventilation is not provided.
7. **Use only** the power source as marked on the unit. If you are not sure of the type of the power supplied to your home, consult your dealer or local Power Company.
8. **Do not** place objects on the power cord. Install the unit where no one can step on the cord.
9. **Do not** overload wall outlets and extension cords as this can result in the risk of fire or electric shock.
10. **Never** push any objects into this unit through slots (other than those specifically meant for credit, debit or smart cards) as they may result in risk of fire or electric shock. **Never** spill any liquid on the unit.
11. To reduce the risk of electric shock, **do not** disassemble any of the equipment or accessories referred to in this manual. If required, take the equipment to a qualified serviceperson. Opening or removing covers **may** expose you to dangerous voltages or other risks. Incorrect re-assembly can cause electric shock.

---

*Continued on next page*

## General and Safety Instructions, Continued

---

**Unplug** this unit from the wall outlet and refer servicing to qualified service personnel under the following conditions:

- When the charger cord or plug is damaged or frayed.
  - Liquid has been spilled into the unit.
12.
  - Unit has been exposed to rain or water.
  - Unit does not work normally, when following the operating instructions.
  - Unit has been dropped or damaged.
  - Unit exhibits a distinct change in performance.
13. During thunderstorms, **disconnect** telephone line, if possible. There may be a remote risk of electric shock from lightning\*.
14. **Never** install telephone wiring during a lightning storm\*.
15. **Never** install telephone jacks in wet locations unless the jack is specifically designed for wet locations\*.
16. **Never** touch non-insulated telephone wires or terminals unless the telephone line has been disconnected at the network interface\*.
17. **Use caution** when installing or modifying telephone lines\*.
18. When in the vicinity of a gas leak, **do NOT** use the NURIT 8000 SECURE, a stand-alone telephone or a telephone connected to a NURIT docking station to report such a leakage.

\* When using the NURIT 8000 SECURE optional docking station and/or external modem.

**IN ADDITION TO THE ABOVE MENTIONED SAFETY INFORMATION, PLEASE NOTE THE FOLLOWING OPERATIONAL SAFETY INSTRUCTIONS AND CAUTIONS!**

Your NURIT 8000 SECURE contains a transmitter and receiver that emit radio frequency (RF) energy. The actual frequency range used by the NURIT 8000 SECURE is radio-modem dependent according to specific model. Digital modulation techniques are used. During radio communication, the local radio system handling the actual communication controls the actual power transmission output level. This output level may typically vary (relative to distance between user location and cell transmit sites.)

---

*Continued on next page*

## General and Safety Instructions, Continued

---

### POSITIONING

The most desired operational position for the terminal is hand-held at an angle of approximately 30°. The unit is also obviously designed for optimal tabletop usage. Try and keep the terminal a short distance from your body.

When used properly, the design of this hand-held wireless terminal complies with European and International standards for the protection of public exposure to radio frequency (RF) magnetic signals.

---

### MEDICAL WARNING!

For those persons using a pacemaker or other medical devices please read the following important safety notes!

Though most electronic equipment and critical medical devices are shielded against radio-frequency signals, it is important to realize the possibilities of potential interference and what standard precautions may be taken.

---

### PACEMAKERS

Industry standards recommend a minimum separation of 6 inches (15 cm) should be kept between a wireless phone-type device and a pacemaker to prevent any potential problems.

Individuals using a pacemaker should:

1. Always keep the NURIT more than 6 inches (15 cm) from the pacemaker when using the unit as a cellular phone or when performing a transaction.
  2. Turn the NURIT **off immediately** if you suspect any problem of interference.
- 

### OTHER MEDICAL TYPE DEVICES

Consult the manufacturer of your medical-type device to determine its level of shielding. Note usage regulations in health facilities. Depending on the proximity to certain equipment, you may be asked not to use your NURIT terminal or one of its accessories.

---

### OTHER ELECTRONIC DEVICES

Radio frequency energy may affect **improperly installed** or **very sensitive systems**. Consult your vehicle manufacturer or air crew (for *possible airborne operation*) respectively regarding typical problems that may arise when using the NURIT. At the time of the publication of this guide, it is known that **all radio-type devices are prohibited to use** while airborne.

---

*Continued on next page*



## General and Safety Instructions, Continued

### ADDITIONAL WARNINGS!

1. Do not use your NURIT 8000 SECURE in an area of potential **explosive atmosphere** e.g., fuel or chemical storage or transfer facilities or any area that you would be advised to turn off your vehicle's engine. In addition, do **NOT** replace your battery pack or charge your NURIT in an area of potential explosive atmosphere.
2. Do **NOT** use your NURIT in a known **blasting area**.
3. Do **NOT** place your NURIT in the area over a vehicle-equipped air bag.
4. *If battery pack has been removed, ensure that no metal objects come in contact with the pack's electrical contacts.*
5. You are using a NURIT terminal designed for use with a built-in internal antenna. Do **NOT** open the unit with the intent of tampering with the antenna system. Doing so may damage the unit and violate FCC (Ministry of Communications) regulations.

### CONVENTIONS

- **Notes, cautions and warnings** are used like this:
- **"Notes"** contain helpful hints and other important information that will help you get better use from your NURIT.
- **"Cautions"** provide information about procedures that, if not observed, could result in damage to the NURIT or other equipment.
- **"Warnings"** mean failure to follow specific procedures and practices may result in personal injury.

### NOTE

*This publication could include technical or typographical errors. Changes are periodically made to our publications; these changes will be incorporated in future editions.*

#### If you ship the product

Carefully pack and send the package prepaid, adequately insured and preferably in the original carton. Attach a postage-paid letter to the outside of the package detailing the complaint.

**PLEASE NOTE: SHIPMENT MUST BE SENT TO AN AUTHORIZED DEALER OR SERVICE CENTER ONLY. PRODUCTS SHIPPED TO OTHER LOCATIONS WILL BE RETURNED AT OWNERS EXPENSE. CONTACT YOUR DEALER FOR THE CORRECT ADDRESS.**

*Continued on next page*

## General and Safety Instructions, Continued

---

### For your future reference

SERIAL NO.

DATE OF PURCHASE

---

 (found on the bottom of the unit)

NAME OF DEALER

DEALER'S ADDRESS

---



---

### Important!

Appendix B of this manual is essential and therefore should be read carefully and thoroughly prior to use of this product. (See page 175)

## General Information

---

### FOREWORD

Thank you for purchasing the NURIT 8000 Secure Wireless Palmtop Transaction Terminal. You now own one of the most advanced electronic point-of-sale (POS) devices manufactured today.

This manual explains basic installation instructions. To fully utilize the features of your terminal, and for general safety purposes, take some time to familiarize yourself with this manual, the terminal or any accessories to be used.

Please store this manual in a safe place for future reference.

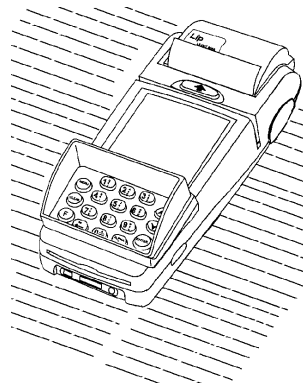

## NURIT 8000 SECURE - General Overview

### Power

---

<b>REQUIREMENTS</b>	<ul style="list-style-type: none"> <li>▪ Terminal power requirements (from AC charger): 8.4 VDC at 1.0A</li> <li>▪ AC charger requirements: 100-240 VAC at 60 Hz (U.S. standard) or; 100-240 VAC at 50 Hz (European standard)</li> </ul>
---------------------	--

---

### Dimensions

<b>TERMINAL</b>	<ul style="list-style-type: none"> <li>▪ Height: 82 mm (3.23 in.)</li> <li>▪ Width: 108 mm (4.26 in.)</li> <li>▪ Depth: 230 mm (9.06 in.)</li> </ul>
-----------------	--

---

<b>PAPER ROLL</b>	<ul style="list-style-type: none"> <li>▪ 57mm (2.25 in.) x 38 mm (1.5 in.)</li> <li>▪ [10.5 mm (0.4 in.) core diameter]</li> </ul>
-------------------	--

### Weight

<b>TERMINAL</b>	<ul style="list-style-type: none"> <li>▪ 650g (1.4 lb.)</li> </ul>
-----------------	--

---

<b>* NOTE</b>	Specifications are subject to change in the interest of technological improvement, without notice or obligation.
---------------	--

---

<b>Technical Assistance</b>	Contact your Lipman representative for technical assistance and ordering information regarding specific components or accessories.
-----------------------------	--

---

# Installation Table of Contents

---

<b>Installation</b>	<b>13</b>
Unpacking Shipping Carton	14
Main Components	14
Optional Accessories	15
Hardware Features of the NURIT 8000 SECURE	16
Top View	16
Bottom View	16
About the Battery Pack	17
About the Battery Pack	17
Installing the Battery Pack	17
Removing the Battery Pack	18
Connecting the AC Charger	18
Installing Optional 33.6 Kbps External Modem	19
Installing the Vehicular Charger	19
Removing the Vehicular Charger	20
Installing the Paper Roll	20
Installing the Keypad Cover	21
Removing the Keypad Cover	21
Using the Magnetic Card Reader	21
Using the Smart Card Reader	22
Installing the GSM Subscriber Identity Module (SIM) Card	22
Connecting Typical Peripheral Device	23
Using an Optional Cellular Headset	23
Infrared (IrDA) Communication Link	24
General Care & Maintenance	24
An Overview of the NURIT 8000 SECURE	25
The Terminal Keyboard	25
Powering the unit On and Off	26

## Installation

---

**SELECTING A LOCATION**

Select a location for the NURIT 8000 SECURE Hand-Held Wireless terminal that is safe and convenient for both the retailer and cardholder.

---

**CAUTION!**

The NURIT 8000 SECURE is designed for indoor use when using the unit's AC charger, optional docking station or optional external modem. The unit is designed to be operated outdoors, but should only be powered by its built-in battery pack. Under no circumstances should the unit be powered or charged outdoors using its AC charger or docking station. Obviously, the NURIT 8000 SECURE **should not be used in areas of excessive moisture or heat.**

Avoid areas with:

- Excess heat, dust or other debris
  - Oil or moisture
- 

**WARNING!**

When connected to the terminal's AC charger, optional docking station or external modem, do not use the terminal near water, including sink, laundry tub or pool. In addition, avoid exposure to:

**Devices that radiate excessive voltage fluctuations or electrical noise, such as air conditioners, fans, electric motors, neon signs, or high-frequency security devices.**

**Direct sunlight or objects that radiate heat.**

**Metal partitions or such obstructions that may disrupt radio reception or transmission.**

---

**WARNING!**

When not operated from its hand-held position, place the NURIT 8000 SECURE on a flat table or countertop. When used in conjunction with its optional external modem or docking station, the terminal should be conveniently located in relation to a telephone line and AC power outlet.

To meet standard ventilation requirements, at least 22.1 centimeters (8.7 inches) of clear space must be provided around the terminal when placed in its fixed operating location.

---

## Unpacking Shipping Carton

When opening the original shipping carton, carefully inspect the contents for any damaged or missing components. Lipman has taken all measures to provide you with a complete unit. If shipping damage is evident, file a claim with the shipping company. Please notify your Lipman distributor concerning this damage, and if any components are missing.

**Instructions** Follow the steps below when unpacking the NURIT 8000 SECURE terminal and its supplied accessories and/or options from carton:

Step	Action
1.	With the carton right side up, remove the carton's outer sleeve.
2.	Open the carton and carefully remove the contents.
3.	<b>Stop.</b>

For your personal safety, do NOT use a NURIT terminal showing any signs of damage!

**Note** Before actual use of the terminal, remove the thin transparent plastic membrane that covers the LCD screen.

## Main Components

### ITEM

- # 1. NURIT 8000 SECURE Terminal
- # 2. AC Charger
- # 3. Paper Roll Spindle
- # 4. Lithium-ion Battery Pack
- # 5. Keypad Cover
- # 6. Thermal Paper Roll
- # 7. Documentation Kit.

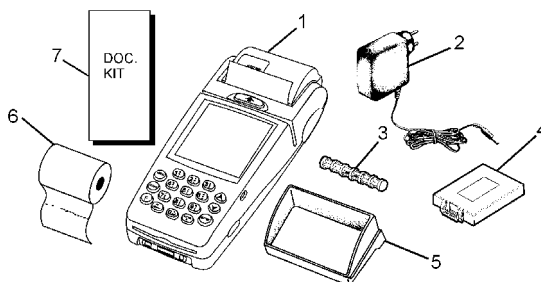

## Optional Accessories

---

- # 1. Docking Station
- # 2. PC-Terminal Download Cable, (Cat. No. FCL09503.)
- # 3. Keyboard Emulation Barcode Reader Adapter Cable (Cat. No. FCL09506.)
- # 4. Terminal-to-Terminal (peer-to-peer) Interconnection Cable, (Cat. No FCL09505.)
- # 5. External Modem
- # 6. Hands-Free Headset (2.5 mm plug) (contact your cellular dealer for purchasing details)
- # 7. Cigarette Lighter Vehicular Charger
- # 8. Touch Screen Stylus
- # 9. Standard RS-232 Barcode Reader Adapter Cable (Cat. No. FCL09504.)

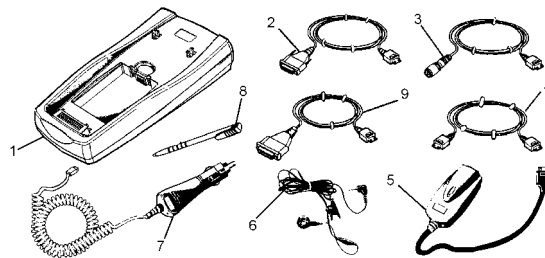

Availability of accessories or options may vary according to customer requirements. At the publication time of this manual, some items may not yet be available. Consult your Lipman representative for details regarding these and any upcoming options. **Connection of any non-Lipman-approved accessory may cause damage and thus void the Limited Warranty of this equipment.**

# Hardware Features of the NURIT 8000 SECURE

Take a few moments to familiarize yourself with the terminal's main feature locators as depicted in the following illustrations.

## Top View

- # 1. Thermal Paper (Receipt)
- # 2. Paper Roll Cover
- # 3. Paper Cover Release Button
- # 4. Graphical Display (Touch Display, Optional)
- # 5. Magnetic Card Reader
- # 6. Keypad
- # 7. Keypad Cover
- # 8. Smart Card Reader
- # 9. IrDA Window
- # 10. Battery Charge Connector
- # 11. Data Connector
- # 12. Headset Connector

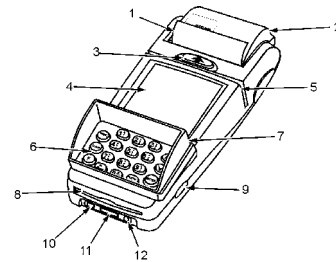

## Bottom View

- # 1. Rubber Stop
- # 2. Radio-Modem Info. Label
- # 3. Model/Barcode-Serial No. Label
- # 4. Compliance Label
- # 5. Battery Pack
- # 6. Battery Pack Removal Snap
- # 7. Docking Station Connector Cover or Connector (Model Dependent)

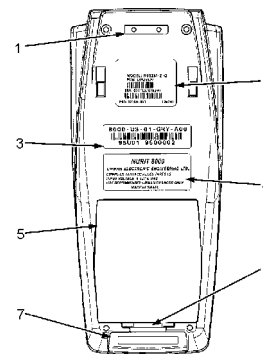



## About the Battery Pack

### SMART LITHIUM-ION BATTERY PACK

The supplied high-performance Lithium-ion battery pack provides 7.2 VDC at 1450 mAh of capacity. When fully discharged, the battery fully recharges within 3 hours while installed in the terminal. An 80% charge capacity is reached within 1 hour. The terminal can be left connected to its AC charger indefinitely without causing damage to the battery.

Under typical use, the battery pack is good for well over 500 charge cycles, after which operating time may very slowly decrease. This battery pack has a self-discharge rate, and without normal use will lose approximately 1% of its charge per day. Replace the battery pack with a new one when the charge capacity is too weak for normal operation. If for any reason you intend not to use your NURIT 8000 SECURE for an extended period of time, remove the battery pack located on the underside of the unit.

### CAUTION!

When using the Lipman-supplied AC charger, the Lithium-ion battery pack **must be installed** in the terminal.

### WARNING!

1. Please do **NOT** dispose of the battery pack in a fire! Dispose of use batteries in accordance with local recycling regulations.
2. If for any reason you intend to remove the NURIT's battery pack, make sure that the metal contacts do not come in contact with any metal objects.

### NOTE

Extreme temperatures will degrade the performance of your battery pack. Do not store this Lithium-ion battery pack in an ambient temperature range below -20°C (4°F) and above 60°C (140°F).

## Installing the Battery Pack

**INSTRUCTION** Use the following step/action table when installing the battery pack:

Step	Action
1.	Carefully invert the terminal. The terminal can be held in hand or gently placed on a soft sponge-like surface so as not to damage the unit's LCD screen.
2.	Insert the battery pack onto the back of the terminal. Note that the side of the pack with the arrow engraved on it should face upward. The insertion is easily done by sliding the 2 tabs in the front of the pack into the 2 openings on the front wall of the battery compartment
3.	Press down on the battery pack until it snaps into place
4.	<b>Stop.</b>

Step 1

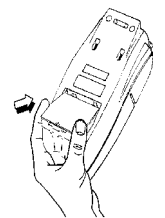

Step 2 →

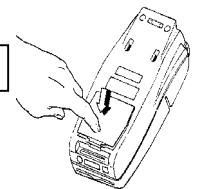

## Removing the Battery Pack

**INSTRUCTION** Use the following step/action table when removing the battery pack:

Step	Action
1.	Hold the terminal in hand or gently place the unit on a soft sponge-like surface in order not to damage the LCD screen.
2.	Remove the battery pack from the back of the unit by grasping the pack's locking snap with a finger or ballpoint pen.
3.	Lift the pack away from the unit.
4.	<b>Stop.</b>

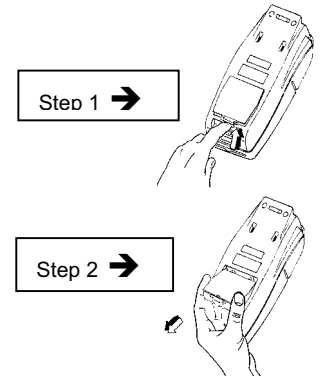

## Connecting the AC Charger

**INSTRUCTION** The NURIT 8000 SECURE can be operated from an AC wall outlet by using the supplied AC charger. Use the following step/action table for assistance.

Step	Action
1.	Plug the connector at the end of the adapter cord into the "power" port on the left side of the NURIT's front panel.
2.	Plug the AC charger into an electrical outlet.
3.	<b>Stop.</b>

**Note:** When the charger's LED indicator light is **green**; the battery is on trickle charge. The LED light is **red** when charging (battery is less than 98% charged). If LED indicator is **not illuminated**, the charger is disconnected from the wall outlet.

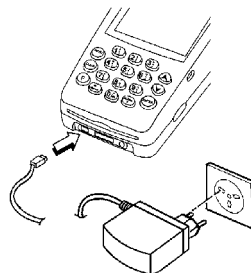

## Installing Optional 33.6 Kbps External Modem

### INSTRUCTION

The optional 33.6 Kbps external fast modem (other baud rates available) enables downloading desired applications and parameters to the NURIT 8000 SECURE via a standard telephone line. Use the following step/action table for assistance.

Step	Action
1.	Insert the modem's data plug into the center "data" port on the front of the NURIT
2.	Connect a standard telephone line cord from the modem to a standard telephone company line socket.
3.	<b>Stop.</b>

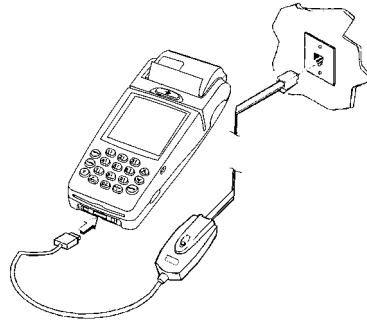

## Installing the Vehicular Charger

### INSTRUCTION

The Vehicular Battery Charger provides power to the NURIT 8000 SECURE and charges the built-in Lithium-ion battery pack. Use the following step/action table for assistance.

Step	Action
1.	Insert the plug at the end of the charger's cord into the "power" port on the left side of the NURIT's front panel.
2.	Remove the cigarette lighter from your vehicle's cigarette lighter socket.
3.	Plug the charger's adapter into the cigarette lighter socket.
4.	<b>Stop.</b>

## Removing the Vehicular Charger

**INSTRUCTION** Use the following step/action table for assistance with removal.

Step	Action
1.	Unplug the adapter from the cigarette lighter socket.
2.	Grasp the plug end of the charger's cord and pull it out of the NURIT's "power" port.
3.	<b>Stop.</b>

## Installing the Paper Roll

**INSTRUCTION** Before you can process any transaction that requires a receipt, you must install a paper roll into the printer compartment. To install this roll, use the following step/action table.

Step	Action
1.	Place the terminal preferably on a flat surface.
2.	Open paper roll cover by pushing the release button in the direction of the arrow appearing on it.
3.	Open the cover.
4.	Remove the paper roll spindle from the paper roll compartment and insert it into the new paper roll.
5.	While holding the roll in hand, mount it together with its spindle in place into the 2 slots on both sides of the compartment. <b>Ensure that the paper roll feeds from the bottom!</b>
6.	Approximately 1 inch (2.5 cm) of paper should extend out of the paper roll compartment (between the cover and serrated tear strip.)
7.	Press down on the front of the paper cover until it snaps in place.
8.	<b>Stop.</b>

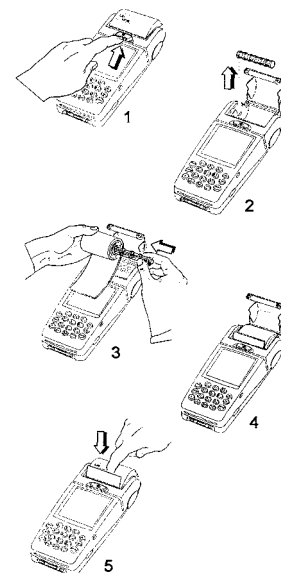

## Installing the Keypad Cover

**INSTRUCTION** Use the following step/action table for assistance installing the keypad cover.

Step	Action
1.	Position the tabs on the inner front sides of the cover over the indentations on both sides of the NURIT (on both sides of the keypad.)
2.	Press down on the cover until it snaps in place.
3.	<b>Stop.</b>

## Removing the Keypad Cover

**INSTRUCTION** Use the following step/action table for assistance removing the keypad cover.

Step	Action
1.	Hold the NURIT securely with one hand.
2.	Grasp the cover with your other hand and lift upward. The cover will easily unsnap from the terminal.
3.	<b>Stop.</b>

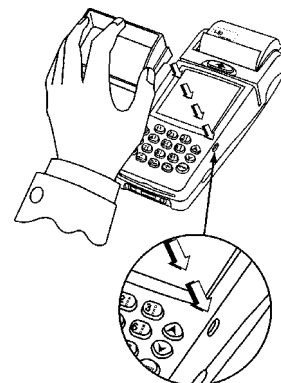

## Using the Magnetic Card Reader

**INSTRUCTION** A magnetic swipe card reader is located between the terminal's LCD screen and paper cover release button.

Step	Action
1.	Grasp the card so that its magnetic stripe is facing you.
2.	Place the card into one end of the card reader groove.
3.	Swipe the card in a smooth continuous manner. This can be done in any direction desired (left-to-right or right-to-left).
4.	<b>Stop.</b>



## Using the Smart Card Reader

**INSTRUCTION** Refer to the following action for assistance using the smart card reader.

Action
Insert the smart card ( <b>chip end first</b> ) into the opening of the reader on the terminal's front panel. For guidance, most smart cards will have directional guide arrows engraved or inscribed on the cards.

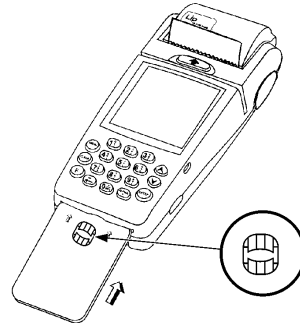

## Installing the GSM Subscriber Identity Module (SIM) Card

**CAUTION!** The SIM card contacts can be easily damaged. Do not bend or scratch when installing or removing the card.

**NOTE** If you are not using a GSM radio modem, an **optional** Security Access Module (SAM) may be installed instead of the SIM card used. The NURIT 8000 SECURE can house up to 2 optional SAM modules.

**INSTRUCTION** The SIM card supplied by your GSM Cellular Service Provider is a special card containing your telephone number, specific service details and memory for storing telephone and messages. Your NURIT terminal can **NOT** receive or make calls without the SIM card installed. Use the following step/action table for assistance.

Step	Action
1.	Grasp the battery pack snap and lift upward.
2.	Open the SIM reader holder by pushing it in the direction of the arrow engraved on it (towards you) and lifting the hinged holder upward.
3.	Hold the SIM card so that its chip side is facing down towards the contacts on the reader.
4.	Insert the SIM card into the grooves on each side of the holder. Make sure that you slide the <b>end closest to the chip</b> into the grooves of the holder <b>first</b> .
5.	Close the SIM cardholder and lock it by pushing it towards the front of the battery pack compartment.
6.	Replace the battery pack on the back of the NURIT. Press down on the pack to lock it in place.

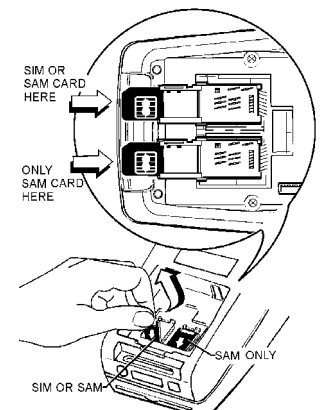

## Connecting Typical Peripheral Device

### INSTRUCTION

Numerous peripheral devices can be used with the NURIT 8000 SECURE terminal. A barcode reader is one such typical device. An interconnection explanation and illustration appear below for a Keyboard Emulation Barcode Reader.

Step	Action
1.	Connect the Barcode Reader to appropriate end of the optional adapter cable (part no. FCL09506).
2.	Insert the other end of the adapter cable into the center “data” port on the unit’s front panel.

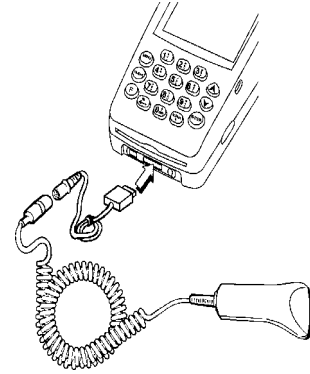

## Using an Optional Cellular Headset

### INSTRUCTION

An optional headset may be used with NURIT 8000 models adapted for cellular telephone communication.

Action
To use the headset, insert its plug into the “stereo-type” port on the right side of the unit’s front panel. When removing the headset from the panel, make sure to <b>grasp the plug</b> and not the cord.

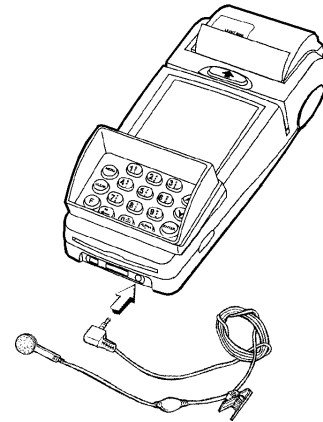

## Infrared (IrDA) Communication Link

**INSTRUCTION** Your NURIT 8000 SECURE (model dependent) is capable of communicating via an infrared communication link.

Action
<p>In order to communicate, the infrared windows of both units must be directed towards each other. Typically, these units can be 2 NURIT 8000 SECURE terminals or a terminal and personal computer.</p> <p>The distance between units should not exceed 11.8 inch (30cm).</p>

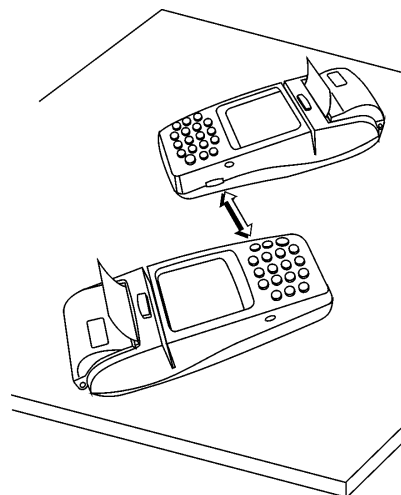

## General Care & Maintenance

**INSTRUCTION** The NURIT 8000 SECURE has been designed to give you long and trouble-free service with minimal operator care. The user should protect the terminal from direct sunlight, extreme heat, dampness and dust.

**CAUTION!** Never use thinners, benzene and synthetic cleansers since they may distort or damage the plastic and critical parts.

**CLEANING THE TERMINAL** For normal cleaning, gently wipe off dirt from the body of the terminal with a soft, damp, lint-free cloth. A **very mild** dishwashing detergent can be used to dampen the cloth. Alcohol or alcohol-based cleansers may also be used for more difficult stains. If available, a **low-pressured** blower can be used to remove dirt accumulated around the keypad buttons and within the paper roll compartment.

If possible, use a lens blower to remove dust and dirt from the LCD screen. When so necessary, gently wipe the screen with a **soft cloth** or **eyeglass lens wiper**.

**CAUTION!** **Never** rub or strongly press on the LCD screen. Doing so may lead to **damage** or other possible problems.



## An Overview of the NURIT 8000 SECURE

**INFORMATION** This section will provide you with a basic understanding of the operations and functionality of the NURIT 8000 SECURE. This will include a keyboard overview and a basic explanation of common terms that you will find throughout this manual.

### The Terminal Keyboard

Key	Function
[Back Arrow – ON/OFF]	Use this key to power the terminal On and Off and as a Back Space when entering data.
[F] (Function Key)	Use this key to batch the terminal in addition to accessing other convenient hot keys.
[MENU/CANCEL]	Use this key to access the terminal's main menus and sub-menus.
[CLEAR]	This key will clear entered data.
[NUMBER PAD]	Used to enter all numeric values. In addition these keys are used in conjunction with the Alpha key to input alphabet text and various symbols.
[ALPHA]	This key converts the numbers on the keypad to their corresponding letters.
[▲] And [▼]	Use these arrow keys to scroll through the menu and submenu options.
[ENTER]	Use this key to make selections.



## Powering the unit On and Off

**Instruction** Use the following steps to power the unit on and off. The terminal can be powered on and off when on AC power and battery pack.

To Power On:

- **Press** the **[ON/OFF]** Button.

To Power Off:

- **Press** the **[F]** button and the **[ON/OFF]** buttons simultaneously
-

# User Guide Table of Contents

<b>INTRODUCTION</b>	<b>1</b>
<b>RETAIL - User Operations</b>	<b>2</b>
Processing Sale Transactions	2
Credit Cards	2
Debit Cards	3
EBT Cards	5
(Electronic Benefits Transfer)	5
Check Sale	7
Cash Sale	8
Processing Retail Sale Transactions – With Tip(s)	8
<b>Voids</b>	<b>10</b>
Void Sale	10
Void Return	11
Void Forced Sale	12
<b>Returns</b>	<b>13</b>
Credit Returns	13
Debit Return	14
Verify	15
Forced Transaction	16
Batching	17
Accessing Hot Keys	18
DL Verification General Report *	21
DL Verification Clerk Report *	22
DL Verification Supported States *	23
Clear Driver License Data *	24
<b>Quick Service Payment</b>	<b>25</b>
<b>Menu Options</b>	<b>29</b>
Accessing the Main Menu	29
<b>1. Reports</b>	<b>30</b>
Print the Default Report	31
Print the Current Report	32
Print History Reports	34
Display Transactions	36
Receipt Copy	38
Print the Performance Report	39
Tip Report	40
Report Set up – Printing Visa/MC Options	42
Report Setup – Tip Discount	43
RAM Disk Report	44
Communication Log Report	45
<b>2. Merchant Parameters</b>	<b>46</b>
Authorizations – TRANSACTION TYPE	46
Authorizations – Card Type	48
Authorizations – Debit Prompt	49

Security Levels	51
Edit Header/Trailer	52
Set Cash EDC	54
Setting the Merchant Fee	55
Set Batch Time	56
Server ID/Clerk ID/Invoice Mode	58
Site ID	60
<b>3. Merchant Options</b>	<b>61</b>
Paper Type	61
Buzzer Set	62
Operation Mode	63
Battery Saver	64
Prints Disclaimer	66
Set Menu Type	67
Set Halo	68
Set Halo	68
Print Setup	70
Store & Forward	71
Turning Store & Forward On/Off	71
Mode Select	72
Display Transactions	75
Reports – Store & Forward	77
Upload Transactions	79
Resend Failed Transactions	80
Delete Failed Transactions	81
Check Reader	82
Check Reader	82
Check Imager – Send Images (Bridge)	83
Check Imager – Send Images (FTP)	85
Check Imager – Clear Images	86
Check Imager – Clear Images	87
Check Imager – Setup Menu (Bridge)	88
Check Imager – Setup Menu (FTP)	89
Check Imager – Franking	95
Signature Option	96
Bridge Communication	97
Language Setup	98
<b>4. Host Parameters</b>	<b>99</b>
Host Parameters	99
Host Phones	101
Print EDC Setup	103
Protocol Version	104
AutoDial Setup	105
Host Radio Address	107
<b>5. System Options</b>	<b>109</b>
Set Terminal Time and Date	109
Edit PIN Key	111
Select Master Key Location	112
Set Batch Number	113
Edit Database	115
Edit Database – Void a Transaction	115

Edit Database – Clearing the Database	117
Edit Database – CLEAR OFFLINE	118
Working Mode	119
Working Mode – TIP OPTIONS	119
Working Mode – AVS OPTIONS	121
Working Mode – Card Present Options	123
Working Mode – Comment Options	125
Predial Call	126
Pin Pad Initialization	127
Pin Pad Initialization	127
Pin Pad Function	128
Pin Pad Configuration	129
Status Bar	130
<b>6. Radio Params</b>	<b>131</b>
Radio Tests - RADIO RSSI	131
Radio Tests - TERMINAL MAN# (MOBITEX ONLY)	132
Radio Tests - Terminal LLI# (Motient Only)	133
Radio Tests - Radio Information	134
Radio Tests - Radio Information	134
Print Params	135
Battery Test	136
Battery Test	136
<b>7. Download</b>	<b>137</b>
Download Definitions	137
Downloading	137
Download – Communication Parameters, Phone	140
Download – Comm Parameters, Exchange Prefix	141
Download – Comm Parameters, Via>	143
Download – Comm Params, Baud Rate	144
Download – Comm Params, Dial>	146
Download – Comm Params, Gateway>	147
Download – Comm Params, Suffix	149
<b>8. Communication</b>	<b>151</b>
Minimum Retries	151
Dial: Tone/Pulse	152
Exchange Prefix	153
Gateway	154
Suffix	155
Via Line/Radio	156
CHECK LINE: ON	157
CHECK LINE: ON	158
<b>Appendix A – Restaurant Tips and Tabs</b>	<b>159</b>
Working Mode – TIP OPTIONS	159
Add Tips	162
Working Mode – Tab Option	164
Open a Tab	165
Close a Tab	166
Delete a Tab	168
Show Tabs	169
Tab Report	170

Open Tab Report	170
Close Tab Report	171
<b>POS STD and PLUS - NURIT 8000 SECURE QUICK REFERENCE GUIDE</b>	<b>172</b>
<b>BASIC TROUBLESHOOTING</b>	<b>174</b>
Appendix B - Lipman USA Licensing Agreement	175
Lipman USA Licensing Agreement, Continued	177

## INTRODUCTION

---

### INFORMATION

Presently, there are three varieties on the 4.82 Application. They include:

- SCA\_STD (for script)
- POS\_STD (this version is supported in NURIT models 2085 and higher)
- POS\_PLUS (this version is supported in NURIT 2085-M21, NURIT 3020, NURIT 8320 and NURIT 8000 terminals The major difference between POS\_STD and POS\_Plus is that Plus supports Magtek in addition to signature capture, RDM, multi-language, the Communication Log Report and the RAM Disk Report. Driver License Verification is supported by application version POS7PLUS only.)

APPLICATION	NURIT MODEL
POS7_STD **	NURIT 2085, NURIT 3010, NURIT 3020, NURIT 8000 SECURE AND NURIT 8320  ** REQUIRES NURIT OPERATING SYSTEM (NOS) 7.8.4 AND ABOVE.

**PLEASE NOTE:** For Merchants requiring PLUS Features, see the information in the following chart.

APPLICATION	NURIT MODEL
POS6PLUS *	NURIT 2085-M21 AND NURIT 3020  * REQUIRES NURIT OPERATING SYSTEM (NOS) 6.00 AND ABOVE.
POS7PLUS **	NURIT 2085-M21, NURIT 3020, NURIT 8000 SECURE AND NURIT 8320  ** REQUIRES NURIT OPERATING SYSTEM (NOS) 7.8.4 AND ABOVE.

**PLEASE NOTE:** The Nurit Control Center version must 7.4.11 or higher when building terminal files with any of these application versions.



---

# RETAIL - User Operations

**INFORMATION** This section explains the various instructions required in operating a NURIT terminal. In this manual, transactions, operations, and specific functions available with the POS\_STD and POS\_PLUS applications are explained. Screen displays are typical of the NURIT 8000 SECURE terminal.

## Processing Sale Transactions

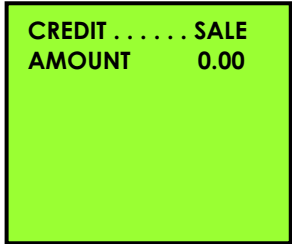
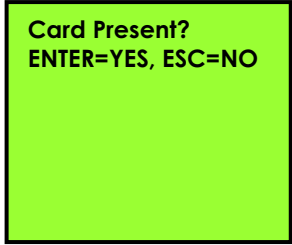
### Credit Cards

STEP	ACTION	DISPLAY
1.	Be sure the terminal is at the Idle Prompt	
2.	<b>Swipe</b> the credit <b>card</b> , or manually key in the account number and expiration date.	
3.	<b>Input</b> the dollar <b>amount</b> of the transaction without a decimal point and press <b>[ENTER]</b>	
4.	<p><b>Press [ENTER]</b> if the card is present at the Point of Sale</p> <p><i>Or</i></p> <p><b>Press [MENU]</b> if the card is <i>not</i> present.</p> <p><b>Note:</b> This prompt is displayed for manually entered transactions only.</p>	
5.	<p><b>Using the stylus, have the customer sign on the touch screen display.</b></p> <p><b>Note:</b> Signature Capture must be enabled. If not enabled or if the customer does not sign on the screen, a blank signature line will print on the receipt.</p>	



Continued on next page

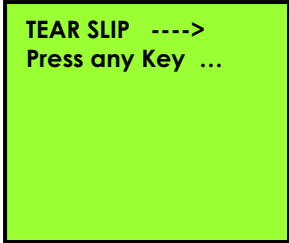

## Credit Cards, Continued

STEP	ACTION	DISPLAY
6.	The terminal will now contact the host for an approval and print a receipt. <b>Press any key</b> for second receipt.	
7.	<b>Stop.</b>	

## Debit Cards

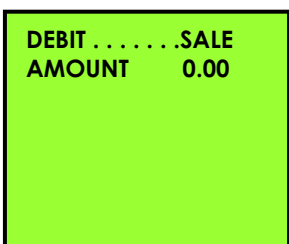
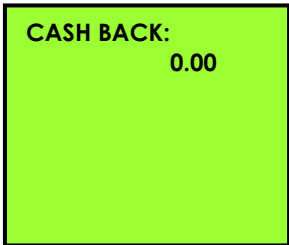
STEP	ACTION	DISPLAY
1.	<b>Press [ENTER]</b> until the Debit prompt is displayed.	
2.	<b>Swipe</b> the debit card. (Debit cards cannot be keyed in manually, they <b>MUST</b> be swiped)	
3.	<b>Input</b> the dollar <b>amount</b> of the transaction without a decimal point. <b>Press [ENTER]</b> .	
4.	The terminal will now Prompt you to enter a Cash Back amount then <b>press [ENTER]</b>  <i>Or</i> <b>Press [ENTER]</b> to bypass.	

Continued on next page

## Debit Cards, Continued

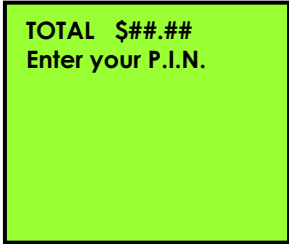
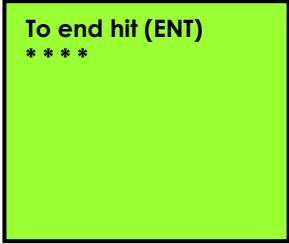
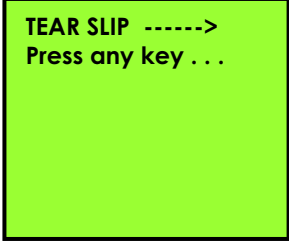
STEP	ACTION	DISPLAY
5.	<p><b>Input the PIN on the Keypad.</b></p> <p><b>Note:</b> When using an external PIN pad you will be prompted on the PIN pad, not on the terminal.</p>	
6.	<p>After PIN has been input <b>press [ENTER]</b>. The terminal will now contact the host for approval and print a receipt.</p>	
7.	<p><b>Press any key</b> for second receipt.</p> <p><b>Note:</b> Terminal must be setup when programmed to print two receipts or Paper Type must be set to Customized.</p>	
8.	<b>Stop.</b>	

# EBT Cards (Electronic Benefits Transfer)

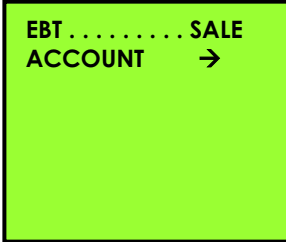
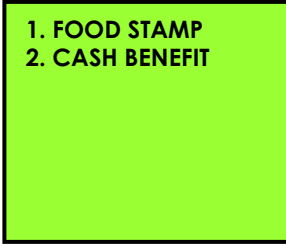
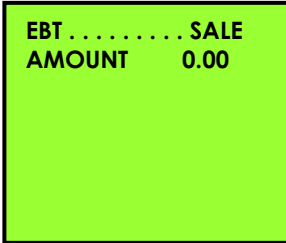
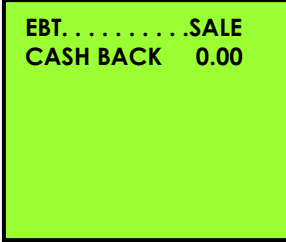
STEP	ACTION	DISPLAY						
1.	From the Idle prompt <b>press [ENTER]</b> until the display identifies an EBT sale. (see right →)							
2.	<b>Swipe the EBT card</b> , or manually enter the account number including the expiration date, or if required, the 'GEN' number.							
3.	<p style="text-align: center;"><b>Press [1]</b> for Food stamp <i>Or</i> <b>Press [2]</b> for Cash Terminal Benefit</p>							
4.	<b>Input</b> the dollar <b>amount</b> of the transaction without a decimal point then <b>press [ENTER]</b>							
5.	<table border="1" style="margin-left: auto; margin-right: auto;"> <thead> <tr> <th data-bbox="613 1199 901 1234">If</th> <th data-bbox="901 1199 1211 1234">Then</th> </tr> </thead> <tbody> <tr> <td data-bbox="613 1234 901 1270">Food Stamp</td> <td data-bbox="901 1234 1211 1270">Go to step #8.</td> </tr> <tr> <td data-bbox="613 1270 901 1306">Cash Benefit</td> <td data-bbox="901 1270 1211 1306">Proceed to next step.</td> </tr> </tbody> </table>		If	Then	Food Stamp	Go to step #8.	Cash Benefit	Proceed to next step.
If	Then							
Food Stamp	Go to step #8.							
Cash Benefit	Proceed to next step.							
6.	The terminal will now Prompt you to enter a Cash Back amount or <b>press [ENTER]</b> to bypass.							

*Continued on next page*

# (Electronic Benefits Transfer), Continued

STEP	ACTION	DISPLAY						
7.	<table border="1" style="margin-left: auto; margin-right: auto;"> <tr> <th data-bbox="641 304 925 336">If</th> <th data-bbox="925 304 1226 336">Then</th> </tr> <tr> <td data-bbox="641 336 925 367">Food Stamp</td> <td data-bbox="925 336 1226 367">Go to step #8.</td> </tr> <tr> <td data-bbox="641 367 925 399">Cash Benefit</td> <td data-bbox="925 367 1226 399">Proceed to next step.</td> </tr> </table>	If	Then	Food Stamp	Go to step #8.	Cash Benefit	Proceed to next step.	
If	Then							
Food Stamp	Go to step #8.							
Cash Benefit	Proceed to next step.							
8.	<p>The terminal will now Prompt you to enter a Cash Back amount or <b>press [ENTER]</b> to bypass.</p>	<div style="border: 1px solid black; background-color: #90EE90; padding: 5px;"> <p>EBT. ....SALE CASH BACK 0.00</p> </div>						
9.	<p><b>Input the PIN</b> on the Keypad then <b>press [ENTER]</b></p>	<div style="border: 1px solid black; background-color: #90EE90; padding: 5px;"> <p>TOTAL \$##.## Enter your P.I.N.</p> </div>						
10.	<p><b>Press any key</b> for second receipt.</p> <p><u>Note:</u> Terminal must be setup when programmed to print two receipts or Paper Type must be set to Customized.</p>	<div style="border: 1px solid black; background-color: #90EE90; padding: 5px;"> <p>TEAR SLIP -----&gt; Press any key . . .</p> </div>						
11.	<p><b>Stop.</b></p>							

# Check Sale

STEP	ACTION	DISPLAY
1.	From the idle prompt <b>press [ENTER]</b> until the display identifies a check sale.	
2.	<b>Input the amount to be verified and Press [ENTER]</b>	
3.	<b>Input the 17 digit MICR number from the check &amp; press [ENTER]</b> <i>Or</i> <b>Place the Check in the Check Reader/Imager</b> <i>* Display will vary depending on check hosts</i>	
4.	If a Check Imager was used, the terminal will display results.	
5.	After completion, a successful storage message will display.	
6.	Terminal will print one receipt if paper type is <b>Single/ Double</b> or two receipts if paper type is <b>Customized</b> .	
7.	<b>Stop.</b>	

## Cash Sale

**INFORMATION** The Cash EDC mode must be turned on to process cash transactions.

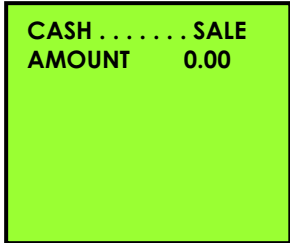
STEP	ACTION	DISPLAY
1.	From the Idle prompt press <b>[ENTER]</b> until the display identifies a Cash Sale. (See right →)	
2.	<b>Input</b> the dollar <b>amount</b> of the sale and <b>press [ENTER]</b>	
3.	Terminal will print one receipt if paper type is <b>Single/Double</b> or two receipts if paper type is <b>Customized</b> .	
4.	<b>Stop.</b>	

## Processing Retail Sale Transactions – With Tip(s)

Turning the Tips function on and off is an option. There may be up to 3 tips/gratuities added per transaction. You can change the name of the tip for identification/reporting and add a default tip amount. Use the following step/action table for assistance processing a sale with tip option #1 turned on.

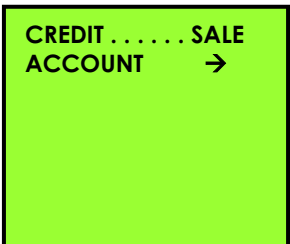
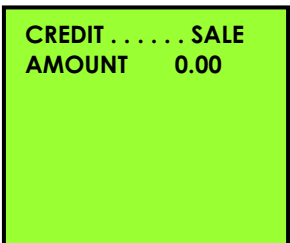
STEP	ACTION	DISPLAY
1.	Be sure the terminal is at the Idle Prompt	
2.	Press <b>[ENTER]</b> until the desired payment method is displayed.	
3.	<b>Swipe</b> the credit <b>card</b> , or manually key in the account number and expiration date.	
4.	<b>Input</b> the dollar <b>amount</b> of the transaction without a decimal point. <b>Press [ENTER]</b> .	

*Continued on next page*

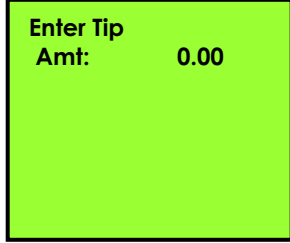
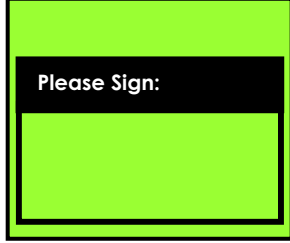
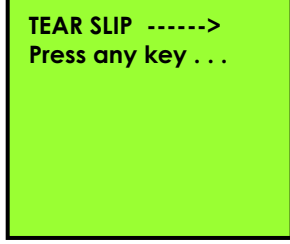

## Processing Retail Sale Transactions – With Tip(s), Continued

STEP	ACTION	DISPLAY
5.	<p>Input the <b>tip amount</b> and press <b>[ENTER]</b></p> <p>OR</p> <p>Press <b>[ENTER]</b> to bypass</p> <p><b>Note:</b> Repeat step for Tip #2 and Tip #3 if necessary.</p>	
6.	The terminal will now contact the host for approval.	
7.	<p><b>If prompted, have the customer sign on the touch screen display using the stylus.</b></p> <p><b>Note:</b> Signature Capture must be enabled. If not enabled or if the customer does not sign on the screen, a blank signature line will print on the receipt.</p>	
8.	If requested, <b>press any key</b> to print second receipt.	
9.	<b>Stop.</b>	

# Voids

## Void Sale

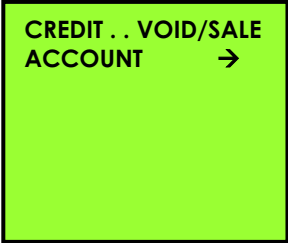

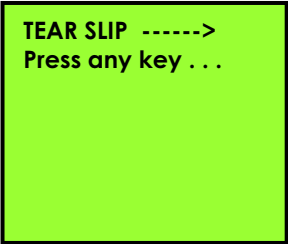
**INFORMATION** A void of a sale can be done if the original sale was Processed in the same batch. If the original sale was NOT Processed in the same batch a Return must be processed.

STEP	ACTION	DISPLAY
1.	From the Idle prompt <b>press</b> the [▲] or [▼] key until the display identifies a Void/Sale. (See right →)	
2.	Swipe the credit card or key in the account number and expiration date manually.	
3.	<b>Input</b> the dollar <b>amount</b> to be voided.	
4.	<b>Press [ENTER].</b> <b>Note:</b> Depending upon the host, the terminal might dial out for authorization.	
5.	<b>Using the stylus, have the customer sign on the touch screen display.</b> <b>Note:</b> Signature Capture must be enabled. If not enabled or if the customer does not sign on the screen, a blank signature line will print on the receipt.	
6.	<b>Press any key</b> to print second receipt.	
7.	<b>Stop.</b>	



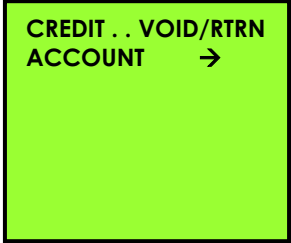

# Void Return

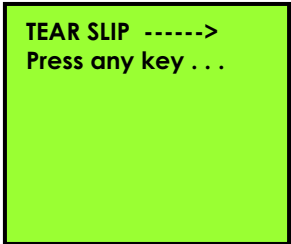
**INFORMATION** A Void Refund is done, if the original return is from the same batch. If the refund is from a different batch, you will not be able to Process a void return.

STEP	ACTION	DISPLAY
1.	From the Idle prompt <b>press</b> the [ <b>▲</b> ] or [ <b>▼</b> ] key until the display identifies a Void/Return. (See right →)	
2.	Swipe the credit card or key in the account number and expiration date manually.	
3.	<b>Input the amount of the return</b> to be voided.	
4.	<b>Press [ENTER].</b> <b>Note:</b> Depending upon the host, the terminal might dial out for authorization.	
5.	<b>Using the stylus, have the customer sign on the touch screen display.</b> <b>Note:</b> Signature Capture must be enabled. If not enabled or if the customer does not sign on the screen, a blank signature line will print on the receipt.	
6.	<b>Press any key</b> to print second receipt.	
7.	<b>Stop.</b>	

## Void Forced Sale

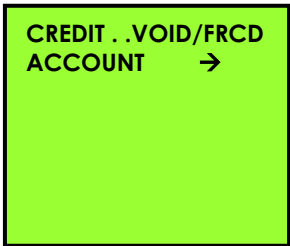

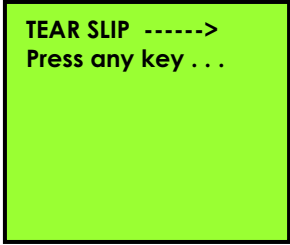
**INFORMATION** A Void Forced Sale is done, if the original Forced Sale is from the same batch. If the forced sale is from a different batch, you will not be able to Process a void forced sale.

STEP	ACTION	DISPLAY
1.	From the Idle prompt <b>press</b> the [▲] or [▼] key until the display identifies a Void/Forced. (See right →)	
2.	Swipe the credit card or key in the account number and expiration date manually.	
3.	<b>Input the amount of the Forced Sale</b> to be voided.	
4.	<b>Press [ENTER].</b> <b>Note:</b> Depending upon the host, the terminal might dial out for authorization.	
5.	<b>Using the stylus, have the customer sign on the touch screen display.</b> <b>Note:</b> Signature Capture must be enabled. If not enabled or if the customer does not sign on the screen, a blank signature line will print on the receipt.	
6.	<b>Press any key</b> to print second receipt.	
7.	<b>Stop.</b>	

# Returns

## Credit Returns

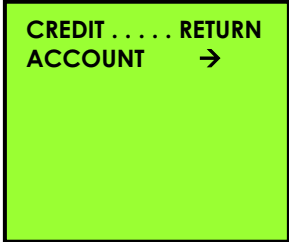
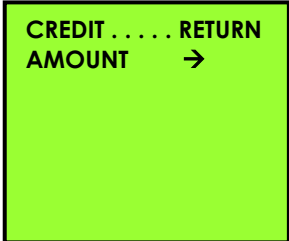
**INFORMATION** A refund to a customer's credit card account can be done if the original sale is from a different batch. If the sale and refund are in the same batch process a Void, otherwise, a refund is done as follows:

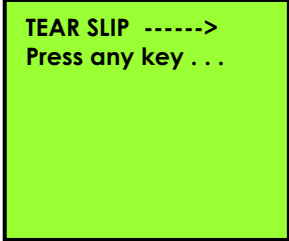
STEP	ACTION	DISPLAY
1.	From the Idle prompt <b>press</b> the [▲] or [▼] key until the display identifies a Return. (See right →)	
2.	Swipe the credit card or key in the account number and expiration date manually.	
3.	<b>Input the amount of the Return.</b> <b>Note:</b> If the original transaction includes a tip amount then the total amount should be entered as the return amount.	
4.	<b>Press [ENTER].</b> <b>Note:</b> Depending on the host you may be prompted to enter the Authorization number from the original transaction.	
5.	<b>Using the stylus, have the customer sign on the touch screen display.</b> <b>Note:</b> Signature Capture must be enabled. If not enabled or if the customer does not sign on the screen, a blank signature line will print on the receipt.	
6.	<b>Press any key</b> to print second receipt.	
7.	<b>Stop.</b>	

## Debit Return

**INFORMATION** A return on a debit transaction can only be done using a bank issued debit card.

STEP	ACTION	DISPLAY
1.	From the Idle prompt <b>press [ENTER]</b> until DEBIT is displayed and then use the [ <b>▲</b> ] or [ <b>▼</b> ] key until the display identifies a DEBIT RETURN. (See right →)	CREDIT . . . . . RETURN ACCOUNT →
2.	Swipe the debit card	
3.	<b>Input the amount of the Return then press [ENTER]</b>  <b>Note:</b> If the original transaction includes a tip amount then the total amount should be entered as the return amount.	DEBIT . . . . . RETURN AMOUNT →
4.	<b>Enter the Authorization</b> number form the original receipt then <b>press [ENTER]</b> .	DEBIT . . . . . RETURN 25.00 ENTER AUTH. No:  
5.	<b>Input the PIN</b> on the Keypad.	TOTAL \$##.## Enter your P.I.N.
6.	After PIN has been input <b>press [ENTER]</b>	To end hit (ENT) * * * *
7.	If prompted, <b>press any key</b> to print second receipt.	
8.	<b>Stop.</b>	

# Verify

---

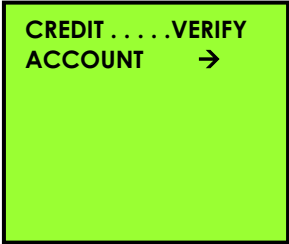
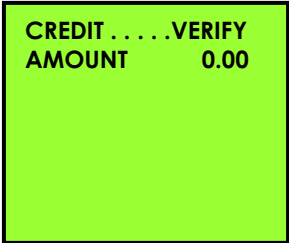

**INFORMATION** This function is used to ensure that a customer has adequate funds on their credit card by obtaining an authorization (**THIS DOES NOT CHARGE THE CUSTOMER'S ACCOUNT**).

STEP	ACTION	DISPLAY
1.	From the Idle prompt <b>press</b> the [▲] or [▼] key until the display identifies a Verify. (See right →)	
2.	Swipe the credit card or key in the account number and expiration date manually.	
3.	<b>Input</b> the <b>amount</b> to be verified.	
4.	<b>Press [ENTER]</b> . The terminal will process the transaction.	
5.	Upon approval, one receipt without a signature line will be printed.	
6.	<b>Stop.</b>	

---

## Forced Transaction

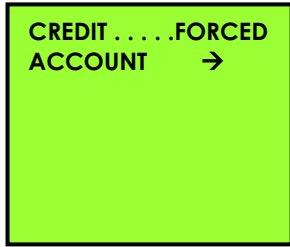
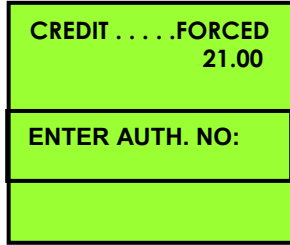
**INFORMATION** When authorization has previously been obtained, a Forced Sale should be done to process the transaction.

STEP	ACTION	DISPLAY
1.	From the Idle prompt <b>press</b> the [▲] or [▼] key until the display identifies a Forced Sale.  (See right →)	
2.	Swipe the credit card or key in the account number and expiration date manually.	
3.	<b>Input the amount of the transaction.</b> This amount should be equal to or less than the amount that was verified.	
4.	Input the authorization number previously obtained.	
5.	<b>Using the stylus, have the customer sign on the touch screen display.</b> <b>Note:</b> Signature Capture must be enabled. If not enabled or if the customer does not sign on the screen, a blank signature line will print on the receipt.	
6.	<b>Press any key</b> for the second receipt to print.	
7.	<b>Stop.</b>	

# Batching

**INFORMATION** To Process a manual batch release, or settlement of transactions stored in the NURIT 8000 SECURE memory, use the following step/action table for assistance

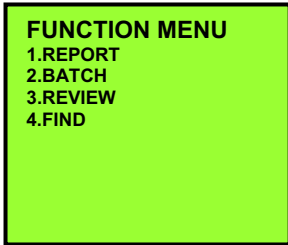
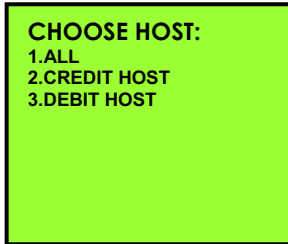
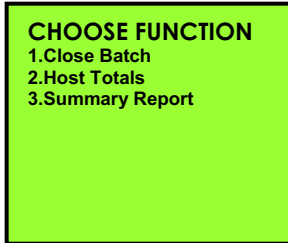
STEP	ACTION	DISPLAY
1.	From the Idle prompt <b>press [F]</b>  (See right →)  <b>Note:</b> Prompts will vary by host.	
2.	<b>Press [2]</b> to start batch process.	
3.	Select the number that corresponds with the host you are batching or <b>press [1]</b> for ALL.  <b>Note:</b> Prompt will vary with terminal setup.	
4.	<b>Press [1]</b> to close the batch.  <b>Note:</b> Prompts will vary by host.	
5.	The terminal will contact the host processor, close the batch and print a batch report.	
6.	<b>Stop.</b>	
<b>Note:</b>	If a terminal is programmed for auto batch, the host will close the batch automatically each night at a specific time and the terminal will print a batch report. However, the transactions will only clear at the time of the first sale of the new batch. Although your terminal will be programmed for auto batch, you still have the option to batch manually. Images are uploaded at the start of the batch process.	

## Accessing Hot Keys

**FUNCTION DESCRIPTION** Hot Keys are short cuts to reports and functions. Hot Keys must be programmed when the terminal file is built and downloaded into the terminal with the application and parameters. A Hot Key List is printed at the end of the Print Setup Report.

**Example of Print Setup Report:**

```
HotKey List:
F1:          Driver License
F2:          Open a Tab
F3:          Close a Tab
```

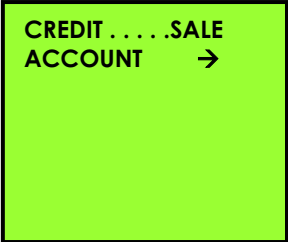
STEP	ACTION	DISPLAY
1.	If necessary, <b>press [MENU/ESC]</b> to return the terminal to the idle prompt.	
2.	<b>Press the [F]</b> key at the same time as pressing the number key on the list. I.E., <b>press [F]</b> and <b>[2]</b> to Open a Tab.	
3.	<b>Stop.</b>	





## Driver License Verification \*

### INFORMATION

This feature is programmable at the *Nurit Control Center* level using one of the terminal's eight hot keys. The Programmed Hot Keys are listed at the bottom of the Setup Report.

**\*NOTE:** All Driver License Verification functions are available with POS7PLUS application only.

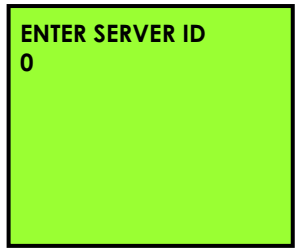
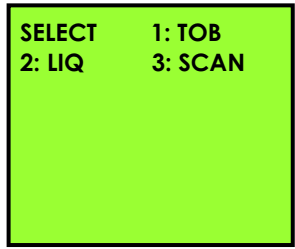
STEP	ACTION	DISPLAY
1.	From the idle prompt, press the <b>[F]</b> key at the same time as pressing the number key for Driver License Verification.	
2.	Swipe the customer's Driver License with the Magnetic strip facing down and to the right.  <b>Note:</b> For a successful swipe the customer's DL must have a magnetic strip.	
3.	Enter the Server ID then press <b>[ENTER]</b> .	
4.	Select the purchase type for the Age Verification.  1. Tobacco 2. Liquor 3. Scan (Displays age and issuing state)	

Continued on next page.

## Driver License Verification, Continued

---

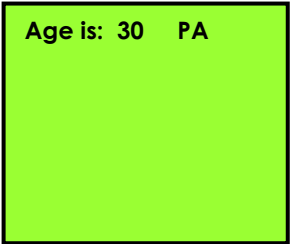
STEP	ACTION	DISPLAY
5.	<p>The terminal will read the magnetic strip and determine if the customer's age is appropriate for the type of purchase.</p> <p><b>Note:</b> Prompts will vary depending on the selection.</p>	
6.	<p>The display will show the customer's age and resident state.</p> <p><b>Note:</b> Prompts will vary by customer.</p>	
7.	<b>Stop.</b>	

---

## DL Verification General Report \*

STEP	ACTION	DISPLAY
1.	From the idle prompt, press the <b>[F]</b> key at the same time as pressing the number key for Driver License Verification.	<pre>CREDIT . . . . . SALE ACCOUNT -&gt;</pre>
2.	Press the <b>[BS]</b> key to list the available functions.	<pre>Swipe DL Card -&gt;</pre>
3.	Press <b>[ENTER]</b> to print the report.	<pre>DRIVER LICENSE 1.General Report 2.Clerk Report 3.Supported States 4.Clear DL Data</pre>
4.	<b>Stop.</b>	

## DL Verification Clerk Report \*

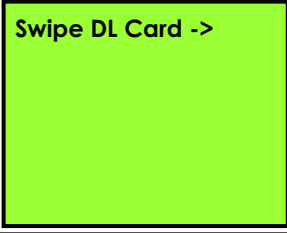
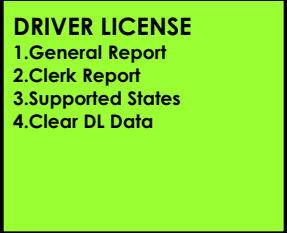
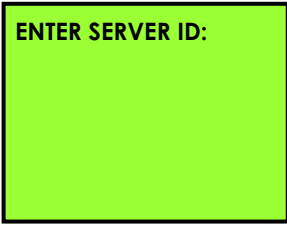
STEP	ACTION	DISPLAY
1.	From the idle prompt, press the <b>[F]</b> key at the same time as pressing the number key for Driver License Verification.	
2.	Press the <b>[BS]</b> key to list the available functions.	
3.	Press <b>[2]</b> to print the Clerk Report.	
4.	Enter the Server ID then press <b>[ENTER]</b> .	
5.	<b>Stop.</b>	

## DL Verification Supported States \*

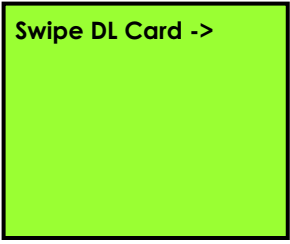
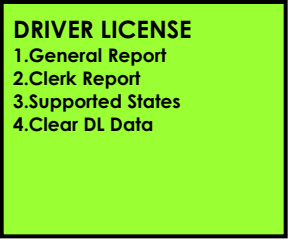
STEP	ACTION	DISPLAY
1.	From the idle prompt, press the <b>[F]</b> key at the same time as pressing the number key for Driver License Verification.	
2.	Press the <b>[BS]</b> key to list the available functions.	
3.	Press <b>[3]</b> for Supported States. A list of the states currently supported will be printed.	
4.	<b>Stop.</b>	

The list of supported states is updated periodically as states change the type of license issued. The following is a list of the supported states when this document was written and might not be current. Print a list from your terminal for the latest information.

AR – Arkansas	MI – Michigan
AZ – Arizona	MN – Minnesota
CA – California	MT – Montana
CO – Colorado	NM – New Mexico
DC – District of Columbia	OH – Ohio
FL – Florida	PA – Pennsylvania
IA – Iowa	TX – Texas
KS – Kansas	VA – Virginia
LA – Louisiana	VT – Vermont
MA – Massachusetts	WI – Wisconsin
MD – Maryland	ON – Ontario, Canada

## Clear Driver License Data \*

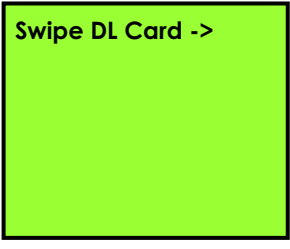
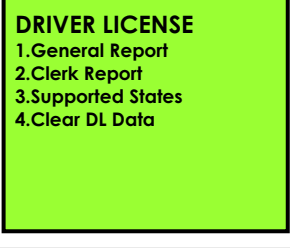
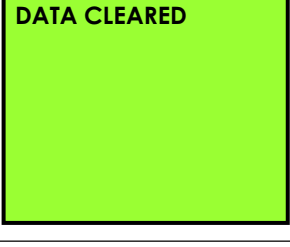
STEP	ACTION	DISPLAY
1.	From the idle prompt, press the <b>[F]</b> key at the same time as pressing the number key for Driver License Verification.	
2.	Press the <b>[BS]</b> key to list the available functions.	
3.	Press <b>[4]</b> to clear the Driver License Data.	
4.	The data will be cleared.	
5.	<b>Stop.</b>	

## Quick Service Payment

**INFORMATION** QSP is used in Fast Food Restaurants, Parking Garages and Motion Picture Theaters (Cinemas). This allows the acceptance of credit cards as the payment method without requiring authorization, receipts or signatures. QSP supports swiped transactions only; manual entry transactions are processed in the normal manner. This means that manual entry transactions will contact the host for authorization and will print a receipt with a signature line. Credit Card sales and voids are the only transaction types supported by QSP. The Credit EDC capture type must be Terminal Based for QSP.

A Floor Limit can be specified for each function (authorization, receipt and signature) for each card type to be processed. This must be specified in the file built for the specific terminal and downloaded into the terminal. QSP Mode information is printed on the Print Setup Report.

This function is available only when supported and requested by the Host Processor. The capture type must be terminal based.

Please review the following chart of default Floor Limits:

CARD TYPE	MERCHANT CATEGORY	DEFAULT FLOOR LIMIT
MASTER CARD	Fast Food Restaurant	\$25.00
MASTER CARD	Parking Garage	\$50.00
MASTER CARD	Cinema	\$35.00
VISA	Restaurant (all types)	\$25.00
VISA	Cinema	\$25.00
VISA	Parking Garage/Lot	\$75.00 for Authorization \$150.00 for Signature and \$25.00 for Receipt

# Processing a QSP Sale

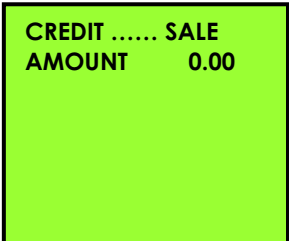
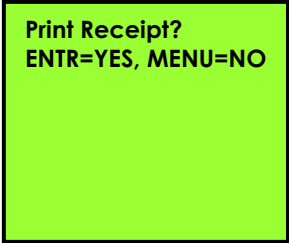

STEP	ACTION	DISPLAY						
1.	Be sure the terminal is at the Idle Prompt							
2.	<b>Swipe</b> the credit <b>card</b> .							
3.	<b>Input</b> the dollar <b>amount</b> of the transaction without a decimal point and press <b>[ENTER]</b>							
4.	<table border="1" data-bbox="350 932 1425 1142"> <thead> <tr> <th data-bbox="350 932 889 982">If</th> <th data-bbox="889 932 1425 982">Then</th> </tr> </thead> <tbody> <tr> <td data-bbox="350 982 889 1066">The transaction amount is less than the authorization floor limit:</td> <td data-bbox="889 982 1425 1066">The Host Processor will not be contacted for authorization.</td> </tr> <tr> <td data-bbox="350 1066 889 1142">The transaction amount is greater than the auth. floor limit:</td> <td data-bbox="889 1066 1425 1142">The terminal will contact the Host for authorization.</td> </tr> </tbody> </table>	If	Then	The transaction amount is less than the authorization floor limit:	The Host Processor will not be contacted for authorization.	The transaction amount is greater than the auth. floor limit:	The terminal will contact the Host for authorization.	
If	Then							
The transaction amount is less than the authorization floor limit:	The Host Processor will not be contacted for authorization.							
The transaction amount is greater than the auth. floor limit:	The terminal will contact the Host for authorization.							
5.	<table border="1" data-bbox="350 1199 1425 1419"> <thead> <tr> <th data-bbox="350 1199 889 1249">If</th> <th data-bbox="889 1199 1425 1249">Then</th> </tr> </thead> <tbody> <tr> <td data-bbox="350 1249 889 1333">The transaction amount is less than the receipt floor limit:</td> <td data-bbox="889 1249 1425 1333">The terminal will display a “<b>Print Receipt?</b>” prompt (see step #6).</td> </tr> <tr> <td data-bbox="350 1333 889 1419">The transaction amount is greater than the floor limit:</td> <td data-bbox="889 1333 1425 1419">A receipt will be printed.</td> </tr> </tbody> </table>	If	Then	The transaction amount is less than the receipt floor limit:	The terminal will display a “ <b>Print Receipt?</b> ” prompt (see step #6).	The transaction amount is greater than the floor limit:	A receipt will be printed.	
If	Then							
The transaction amount is less than the receipt floor limit:	The terminal will display a “ <b>Print Receipt?</b> ” prompt (see step #6).							
The transaction amount is greater than the floor limit:	A receipt will be printed.							
6.	Press <b>[ENTER]</b> to print a receipt or <b>[MENU/ESC]</b> for no receipt.							



## Processing a QSP Sale, Continued

STEP	ACTION	DISPLAY
7.	<b>If</b>	<b>Then</b>
	The transaction amount is less than the signature floor limit:	The receipt will not have a signature line.
	The transaction amount is greater than the signature floor limit:	The receipt will have a signature line.
8.	<b>Press any key</b> for second receipt to print.	
9.	<b>Stop.</b>	

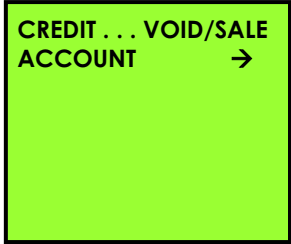
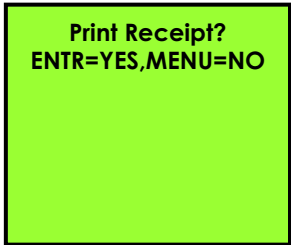
## Voiding a QSP Sale

STEP	ACTION	DISPLAY						
1.	From the Idle prompt press <b>[VOID]</b> until the display identifies a Void/Sale.  (See right →)							
2.	Swipe the credit card or key in the account number and expiration date manually.							
3.	<b>Input</b> the dollar <b>amount</b> to be voided then <b>press [ENTER]</b> .							
4.	<table border="1"> <thead> <tr> <th>If</th> <th>Then</th> </tr> </thead> <tbody> <tr> <td>The transaction amount is less than the receipt floor limit:</td> <td>The terminal will display a “<b>Print Receipt?</b>” prompt (see step #5).</td> </tr> <tr> <td>The transaction amount is greater than the floor limit:</td> <td>A receipt will be printed.</td> </tr> </tbody> </table>		If	Then	The transaction amount is less than the receipt floor limit:	The terminal will display a “ <b>Print Receipt?</b> ” prompt (see step #5).	The transaction amount is greater than the floor limit:	A receipt will be printed.
If	Then							
The transaction amount is less than the receipt floor limit:	The terminal will display a “ <b>Print Receipt?</b> ” prompt (see step #5).							
The transaction amount is greater than the floor limit:	A receipt will be printed.							
5.	<b>Press [ENTER]</b> to print a receipt or <b>[MENU/ESC]</b> for no receipt.							
6.	<table border="1"> <thead> <tr> <th>If</th> <th>Then</th> </tr> </thead> <tbody> <tr> <td>The transaction amount is less than the signature floor limit:</td> <td>The receipt will not have a signature line.</td> </tr> <tr> <td>The transaction amount is greater than the signature floor limit:</td> <td>The receipt will have a signature line.</td> </tr> </tbody> </table>		If	Then	The transaction amount is less than the signature floor limit:	The receipt will not have a signature line.	The transaction amount is greater than the signature floor limit:	The receipt will have a signature line.
If	Then							
The transaction amount is less than the signature floor limit:	The receipt will not have a signature line.							
The transaction amount is greater than the signature floor limit:	The receipt will have a signature line.							
7.	<b>Press any key</b> for second receipt to print.							
8.	<b>Stop.</b>							

## Menu Options

**INFORMATION** The NURIT 8000 SECURE has a menu with several options that control many of the terminal's basic operational functions. The menu is divided into main menus and sub-menus that can be accessed by pressing the **[MENU/CANCEL]** key.

### Accessing the Main Menu

STEP	ACTION	DISPLAY
1.	From the Idle Prompt press the <b>[MENU/CANCEL]</b> key.	<pre>CREDIT ..... SALE ACCOUNT -&gt;</pre>
2.	Use the <b>[▲]</b> and <b>[▼]</b> keys to scroll through the options then <b>press [ENTER]</b> to select.  <i>OR</i>  <b>Press</b> the number on the keypad that corresponds with your selection.	<pre>MENU SCREEN: 1.Reports 2.Merch. Params 3.Merch. Option 4.Host Params 5.System Options 6.Radio Params 7.Download 8.Communication 9.NOS Menu</pre>
3.	<b>Press [MENU/CANCEL]</b> to return to the idle <b>CREDIT . . . . . SALE</b> prompt.	
4.	<b>Stop.</b>	

# 1. Reports

---

The first menu is the Report Menu, which generates ten different types of reports:

**MENU  
DESCRIPTION**

- Default Report     Current Report     History Report     Display Transactions  
 Receipt Copy     Performance     Tip Report     Report Setup  
 RAM DISK Report \*     Communication Log Report \*

**\*NOTE:** These features are available with the POS\_PLUS application only.

---

**REPORT  
TYPES**

You will be prompted in some Report sub-menus to choose a report type. Below is a list of report types and their definitions.

REPORT	DEFINITION
<b>CONDENSED REPORT</b>	This type of report will print the transaction number, card type, transaction type, last four digits of the account number, and the amount of the sale.
<b>SHORT REPORT</b>	This type of report will print the transaction type and the amount of the sale.
<b>JOURNAL REPORT</b>	This type of report will print a full receipt style copy of each transaction.
<b>TOTALS ONLY</b>	This type of report will print daily totals only.

---

## Print the Default Report

---

**FUNCTION DESCRIPTION** This is a report of the terminal's daily transactions, which has been customized, or has set defaults from the Current Report (see Current Report on the following page).

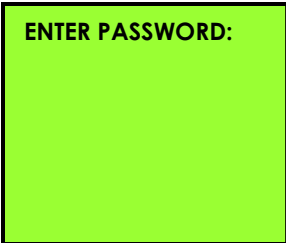
STEP	ACTION	DISPLAY
1.	From the main MENU SCREEN <b>press [ENTER/CANCEL]</b>  <u>OR</u>  <b>Press [1]</b> to access the Reports Menu	
2.	<b>Input the Password and press [ENTER].</b>	
3.	From the Reports Menu <b>Press [ENTER]</b> <u>OR</u> <b>Press [1]</b> to select Default Report	
4.	<b>Stop.</b>	

---

# Print the Current Report

## FUNCTION DESCRIPTION

Current report will print the terminal's daily transactions, and can be customized with specific options. This is where the Default Report is set.

STEP	ACTION	DISPLAY
1.	From the Main Menu, <b>press [1]</b> to access the Reports Menu. <b>Input the Password and press [ENTER].</b>	<div style="border: 1px solid black; background-color: #90EE90; padding: 5px;"> <b>MENU SCREEN:</b>            1.Reports            2.Merch. Params            3.Merch. Options            4.Hosts Params            5.System Options            6.Radio Params            7.Download            8.Communication            9.NOS Menu         </div>
2.	<b>Press [2]</b> to select Current Report	<div style="border: 1px solid black; background-color: #90EE90; padding: 5px;"> <b>REPORTS:</b>            1.Default Report            2.Current Report            3.History Report            4.Display Trans.            5.Last Receipt            6.Performance            7.Tip Report            8.Report Setup            9.RAMDISK Report         </div>
3.	Use the [ <b>▲</b> ] and [ <b>▼</b> ] keys to scroll through the Report Type options then <b>press [ENTER]</b> to select. <u>OR</u> <b>Press</b> the number corresponding with your selection.	<div style="border: 1px solid black; background-color: #90EE90; padding: 5px;"> <b>CUR. REPORT TYPE</b>            1.Condensed Rprt            2.Short Report            3.Journal Report            4. TOTALS ONLY         </div>
4.	Use the [ <b>▲</b> ] and [ <b>▼</b> ] keys to scroll through the EDC Type options then <b>press [ENTER]</b> to select. <u>OR</u> <b>Press</b> the number corresponding with your selection	<div style="border: 1px solid black; background-color: #90EE90; padding: 5px;"> <b>CHOOSE EDC TYPE</b>            1.ALL            2.CREDIT            3.DEBIT         </div>
5.	Use the [ <b>▲</b> ] and [ <b>▼</b> ] keys to scroll through the Card Type options then <b>press [ENTER]</b> to select. <u>OR</u> <b>Press</b> the number corresponding with your selection	<div style="border: 1px solid black; background-color: #90EE90; padding: 5px;"> <b>ENTER CARD TYPE</b>            1.ALL            2.VISA            3.MasterCard            4.AMEX            5.Diners            6.CarteBlanch            7.Disc/NOVUS            8.enRoute            9.JCB         </div>

Continued on next page

## Print the Current Report, Continued

STEP	ACTION	DISPLAY						
6.	Use the [▲] and [▼] keys to scroll through Sorting Options then <b>press [ENTER]</b> to select.  <u>OR</u>  <b>Press</b> the number corresponding with your selection	<div style="border: 1px solid black; background-color: #90EE90; padding: 5px;"> <b>SORT METHOD:</b>            1.By Trans #            2.By Card Type            3.By Server ID         </div>						
7.	Use the [▲] and [▼] keys to scroll through the Transaction Type options then <b>press [ENTER]</b> to select.  <u>OR</u>  <b>Press</b> the number corresponding with your selection	<div style="border: 1px solid black; background-color: #90EE90; padding: 5px;"> <b>CHOOSE TRAN. TYPE</b>            1.ALL            2.SALE            3.FORCED            4.VERIFY            5.RETURN            6.VOID/SALE            7.VOID/RTRN            8.VOID/FRCD         </div>						
8.	<table border="1" style="width: 100%; border-collapse: collapse;"> <thead> <tr> <th style="width: 50%; text-align: center;">To</th> <th style="width: 50%; text-align: center;">Then</th> </tr> </thead> <tbody> <tr> <td style="text-align: center;">Save this as your default report</td> <td style="text-align: center;">Press <b>[ENTER]</b></td> </tr> <tr> <td style="text-align: center;">Keep your current default setting</td> <td style="text-align: center;">Press <b>[MENU]</b></td> </tr> </tbody> </table>	To	Then	Save this as your default report	Press <b>[ENTER]</b>	Keep your current default setting	Press <b>[MENU]</b>	<div style="border: 1px solid black; background-color: #90EE90; padding: 5px;"> <b>Set Cur. Defaults?</b>  <b>ENTR=YES,MENU=NO</b> </div>
To	Then							
Save this as your default report	Press <b>[ENTER]</b>							
Keep your current default setting	Press <b>[MENU]</b>							
9.	<b>Stop.</b>							

# Print History Reports

## FUNCTION DESCRIPTION

This report will allow you to print previous batch totals for the last 300 batches. You can print a total report of several batches, or you can print a report showing totals per batch.

STEP	ACTION	DISPLAY
1.	From the Main Menu, <b>press [1]</b> to access the Reports Menu. <b>Input the Password and press [ENTER].</b>	<b>MENU SCREEN:</b> 1.Reports 2.Merch. Params 3.Merch. Options 4.Hosts Params 5.System Options 6.Radio Params 7.Download 8.Communication 9.NOS Menu
2.	<b>Press [3]</b> to select History Report.	<b>REPORTS:</b> 1.Default Report 2.Current Report 3.History Report 4.Display Trans. 5.Last Receipt 6.Performance 7.Tip Report 8.Report Setup 9.RAMDISK Report
	Using the numeric keypad input the batch date you would like the report to begin with.  Then <b>press [ENTER]</b>	<b>From Batch Date:</b> 10/01/02
3.	Using the numeric keypad input the batch date you would like the report to end with.  Then <b>press [ENTER]</b>	<b>To Batch Date:</b> 10/15/02
4.	Use the [ <b>▲</b> ] and [ <b>▼</b> ] keys to select if you would like the report by Total or Per Batch then <b>press [ENTER]</b>  <i>OR</i> Press the number corresponding with your selection	<b>HISTORY REPORTS</b> 1.Total 2.Per Batch

*Continued on next page*



## Print History Reports, Continued

STEP	ACTION	DISPLAY
5.	<p>Use the [▲] and [▼] keys to scroll through the EDC Type options then <b>press [ENTER]</b> to select.</p> <p style="text-align: center;"><u>OR</u></p> <p><b>Press</b> the number corresponding with your selection</p>	<div style="border: 1px solid black; background-color: #90EE90; padding: 5px;"> <p><b>CHOOSE EDC TYPE</b></p> <p>1.ALL 2.CREDIT 3.DEBIT</p> </div>
6.	<p>Use the [▲] and [▼] keys to scroll through the Card Type options then <b>press [ENTER]</b> to select.</p> <p style="text-align: center;"><u>OR</u></p> <p><b>Press</b> the number corresponding with your selection</p>	<div style="border: 1px solid black; background-color: #90EE90; padding: 5px;"> <p><b>ENTER CARD TYPE</b></p> <p>1.ALL 2.VISA 3.MasterCard 4.AMEX 5.Diners 6.CarteBlanch 7.Disc/NOVUS 8.enRoute 9.JCB</p> </div>
7.	<p>Use the [▲] and [▼] keys to scroll through the Transaction Type options then <b>press [ENTER]</b> to select.</p> <p style="text-align: center;"><u>OR</u></p> <p><b>Press</b> the number corresponding with your selection</p>	<div style="border: 1px solid black; background-color: #90EE90; padding: 5px;"> <p><b>CHOOSE TRAN. TYPE</b></p> <p>1.ALL 2.TOTALS ONLY 3.SALE 4.FORCED 5.VERIFY 6.RETURN 7.VOID/SALE 8.VOID/RTRN</p> </div>
8.	<b>Stop.</b>	

# Display Transactions

## FUNCTION DESCRIPTION

This option will allow you to view daily transactions on the terminal display. You can also print another receipt copy of the displayed transaction or void that transaction.

STEP	ACTION	DISPLAY
1.	From the Main Menu, <b>press [1]</b> to access the Reports Menu. <b>Input the Password and press [ENTER].</b>	<b>MENU SCREEN:</b> 1.Reports 2.Merch. Params 3.Merch. Options 4.Hosts Params 5.System Options 6.Radio Params 7.Download 8.Communication 9.NOS Menu
2.	<b>Press [4]</b> to select Display Trans.	<b>REPORTS:</b> 1.Default Report 2.Current Report 3.History Report 4.Display Trans. 5.Last Receipt 6.Performance 7.Tip Report 8.Report Setup 9.RAMDISK Report
3.	Use the [ <b>▲</b> ] and [ <b>▼</b> ] keys to select the method you would like to view the transaction then <b>press [ENTER].</b>  <i>OR</i> <b>Press</b> the number corresponding with your selection	<b>Display Trans.</b> 1.Scroll All 5.By Trans. # 6.By Card Type 7.By Card Num.  <b>Note:</b> Subsequent prompts will vary with this menu choice.
4.	Use the [ <b>▲</b> ] and [ <b>▼</b> ] keys to scroll through the EDC Type options then <b>press [ENTER]</b> to select.  <i>OR</i> <b>Press</b> the number corresponding with your selection	<b>CHOOSE EDC TYPE</b> 2.CREDIT 3.DEBIT 4.EBT 5.Cash

Continued on next page

## Display Transactions, Continued

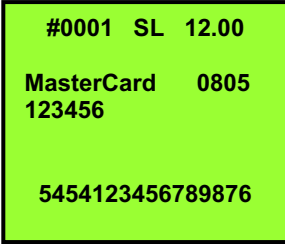
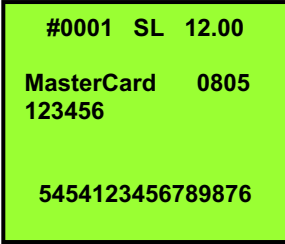
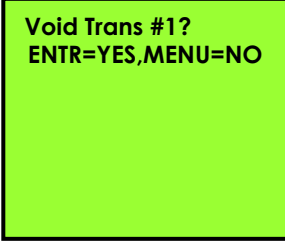
STEP	ACTION	DISPLAY										
5.	<table border="1"> <thead> <tr> <th data-bbox="380 317 675 394">If</th> <th data-bbox="675 317 1375 394">Then</th> </tr> </thead> <tbody> <tr> <td data-bbox="380 394 675 520">You selected to scroll through all transaction</td> <td data-bbox="675 394 1375 520">The first transaction will show on the display. <b>FORCED</b> will allow you to scroll through the transactions.</td> </tr> <tr> <td data-bbox="380 520 675 646">You selected to view by Transaction #</td> <td data-bbox="675 520 1375 646">You will be prompted to input the Transaction #</td> </tr> <tr> <td data-bbox="380 646 675 743">You selected to view by Card Type</td> <td data-bbox="675 646 1375 743">You will be prompted to select a card type</td> </tr> <tr> <td data-bbox="380 743 675 869">If you selected to view by Card Number</td> <td data-bbox="675 743 1375 869">You will be prompted to enter the last four digits of the card number.</td> </tr> </tbody> </table>	If	Then	You selected to scroll through all transaction	The first transaction will show on the display. <b>FORCED</b> will allow you to scroll through the transactions.	You selected to view by Transaction #	You will be prompted to input the Transaction #	You selected to view by Card Type	You will be prompted to select a card type	If you selected to view by Card Number	You will be prompted to enter the last four digits of the card number.	
	If	Then										
	You selected to scroll through all transaction	The first transaction will show on the display. <b>FORCED</b> will allow you to scroll through the transactions.										
	You selected to view by Transaction #	You will be prompted to input the Transaction #										
You selected to view by Card Type	You will be prompted to select a card type											
If you selected to view by Card Number	You will be prompted to enter the last four digits of the card number.											
6.	<p>To print another copy of the receipt for this transaction <b>press [ALPHA]</b>.</p> <p><b>Note:</b> Display will reflect your transaction.</p>											
7.	<p>To Void this transaction <b>press [CLEAR]</b>.</p> <p><b>Note:</b> Display will reflect your transaction.</p>											
8.	<p><b>Press [ENTER]</b>.</p>											
9.	<b>Stop.</b>											

# Receipt Copy

## FUNCTION DESCRIPTION

This option will print a Merchant's copy (full account number and signature line) of the last transaction, a Customer copy (truncated account number) of the last transaction or a copy (Customer) of any receipt. If any function was executed after the transaction, the last receipt function cannot be accessed; the any receipt function must be used.

STEP	ACTION	DISPLAY
1.	From the Main Menu, <b>press [1]</b> to access the Reports Menu. <b>Input the Password and press [ENTER].</b>	<b>MENU SCREEN:</b> 1.Reports 2.Merch. Params 3.Merch. Options 4.Hosts Params 5.System Options 6.Radio Params 7.Download 8.Communication 9.NOS Menu
2.	<b>Press [5]</b> to select Receipt Copy.	<b>REPORTS:</b> 1.Default Report 2.Current Report 3.History Report 4.Display Trans. 5.Last Receipt 6.Performance 7.Tip Report 8.Report Setup 9.RAMDISK Report
3.	<b>Press</b> the number that corresponds to the type of receipt required.	<b>RECEIPT COPY:</b> 1.Last Cust. Rcpt 2.Any Receipt 3.Last Mrch. Rcpt
4.	If Any Receipt was selected, choose the EDC type by <b>pressing</b> the corresponding number.  <b>Note:</b> Display will reflect terminal setup.	<b>CHOOSE EDC TYPE</b> 2.CREDIT 3.DEBIT 4.CASH
5.	<b>Enter</b> the number of the transaction requiring the receipt then <b>press [ENTER].</b>	<b>CHOOSE EDC TYPE</b> 2.CREDIT 3.DEBIT 4.CASH <hr/> <b>Transaction # ?</b> <hr/>
6.	<b>Stop.</b>	

# Print the Performance Report

**FUNCTION DESCRIPTION** This option will print a report listing the percentages of denials, approvals, swipes, manual entries, etc.

STEP	ACTION	DISPLAY						
1.	From the Main Menu, <b>press [1]</b> to access the Reports Menu. <b>Input the Password and press [ENTER].</b>	<div style="border: 1px solid black; background-color: #90EE90; padding: 5px;"> <p><b>MENU SCREEN:</b></p> <ul style="list-style-type: none"> <li>1.Reports</li> <li>2.Merch. Params</li> <li>3.Merch. Options</li> <li>4.Hosts Params</li> <li>5.System Options</li> <li>6.Radio Params</li> <li>7.Download</li> <li>8.Communication</li> <li>9.NOS Menu</li> </ul> </div>						
2.	<b>Press [6]</b> to select Performance.	<div style="border: 1px solid black; background-color: #90EE90; padding: 5px;"> <p><b>REPORTS:</b></p> <ul style="list-style-type: none"> <li>1.Default Report</li> <li>2.Current Report</li> <li>3.History Report</li> <li>4.Display Trans.</li> <li>5.Last Receipt</li> <li>6.Performance</li> <li>7.Tip Report</li> <li>8.Report Setup</li> <li>9.RAMDISK Report</li> </ul> </div>						
3.	Use the [ <b>▲</b> ] and [ <b>▼</b> ] keys to scroll through the EDC Type options then <b>press [ENTER]</b> to select.  <i>OR</i> <b>Press</b> the number corresponding with your selection.	<div style="border: 1px solid black; background-color: #90EE90; padding: 5px;"> <p><b>CHOOSE EDC TYPE</b></p> <ul style="list-style-type: none"> <li>2.CREDIT</li> <li>3.DEBIT</li> <li>4.EBT</li> </ul> </div>						
4.	The Performance Report will print. <table border="1" style="width: 100%; border-collapse: collapse;"> <thead> <tr> <th style="width: 50%;">To</th> <th style="width: 50%;">Then</th> </tr> </thead> <tbody> <tr> <td>Reset the Performance Report</td> <td>Press <b>[ENTER]</b> *You will be prompted to input the password</td> </tr> <tr> <td>Keep the Default Report data</td> <td>Press <b>[MENU]</b></td> </tr> </tbody> </table>	To	Then	Reset the Performance Report	Press <b>[ENTER]</b> *You will be prompted to input the password	Keep the Default Report data	Press <b>[MENU]</b>	<div style="border: 1px solid black; background-color: #90EE90; padding: 5px;"> <p>Reset perf rpt? ENTR=YES, MENU=NO</p> </div>
To	Then							
Reset the Performance Report	Press <b>[ENTER]</b> *You will be prompted to input the password							
Keep the Default Report data	Press <b>[MENU]</b>							
5.	<b>Stop.</b>							

# Tip Report

## FUNCTION DESCRIPTION

This option will print a report that provides tip detail by server number.

STEP	ACTION	DISPLAY
1.	From the Main Menu, <b>press [1]</b> to access the Reports Menu. <b>Input the Password and press [ENTER].</b>	<b>MENU SCREEN:</b> 1.Reports 2.Merch. Params 3.Merch. Options 4.Hosts Params 5.System Options 6.Radio Params 7.Download 8.Communication 9.NOS Menu
2.	<b>Press [7]</b> to select Tip Report.	<b>REPORTS:</b> 1.Default Report 2.Current Report 3.History Report 4.Display Trans. 5.Last Receipt 6.Performance 7.Tip Report 8.Report Setup 9.RAMDISK Report
3.	<b>Press [1]</b> to view report for ALL servers  <i>OR</i> <b>Press [2]</b> to view report for a specific server.	<b>CHOOSE SERVER</b> 1. ALL 2.Specific Servr
4.	Use the [ <b>▲</b> ] and [ <b>▼</b> ] keys to scroll through the EDC Type options then <b>press [ENTER]</b> to select.  <i>OR</i> Press the number corresponding with your selection	<b>CHOOSE EDC TYPE</b> 1.ALL 2.CREDIT 3.DEBIT 4.EBT 5.CASH
5.	Use the [ <b>▲</b> ] and [ <b>▼</b> ] keys to scroll through the Card Type options then <b>press [ENTER]</b> to select.  <i>OR</i> Press the number corresponding with your selection	<b>ENTER CARD TYPE</b> 1.ALL 2.VISA 3.MasterCard 4.AMEX 5.Diners 6.CarteBlanch 7.Disc/NOVUS 8.enRoute 9.JCB

Continued on next page.

## Tip Report, Continued

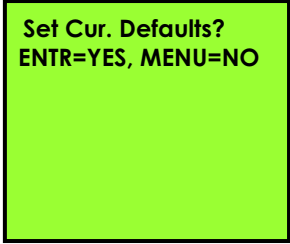

---

STEP	ACTION		DISPLAY					
6.	<table border="1"> <thead> <tr> <th data-bbox="490 380 680 443">To</th> <th data-bbox="680 380 849 443">Then</th> </tr> </thead> <tbody> <tr> <td data-bbox="490 443 680 569">Save this as your default report</td> <td data-bbox="680 443 849 569">Press [ENTER]</td> </tr> <tr> <td data-bbox="490 569 680 743">Keep your current default setting</td> <td data-bbox="680 569 849 743">Press [MENU]</td> </tr> </tbody> </table>	To	Then	Save this as your default report	Press [ENTER]	Keep your current default setting	Press [MENU]	
To	Then							
Save this as your default report	Press [ENTER]							
Keep your current default setting	Press [MENU]							
7.	<b>Stop.</b> The report will begin printing.							

---

## Report Set up – Printing Visa/MC Options

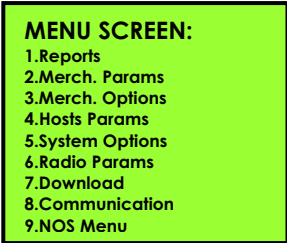
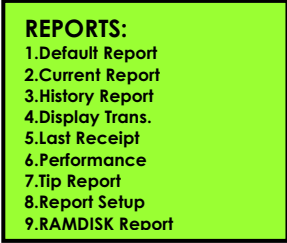
**FUNCTION DESCRIPTION** This function allows the option of having Visa and MasterCard print together (default) or separately. The report must be sorted by card type for the Visa and MasterCard transactions to be separate.

STEP	ACTION	DISPLAY
1.	From the Main Menu, <b>press [1]</b> to access the Reports Menu. <b>Input the Password and press [ENTER].</b>	 <p><b>MENU SCREEN:</b>  1.Reports  2.Merch. Params  3.Merch. Options  4.Hosts Params  5.System Options  6.Radio Params  7.Download  8.Communication  9.NOS Menu</p>
2.	<b>Press [8]</b> to select Report Setup.	 <p><b>REPORTS:</b>  1.Default Report  2.Current Report  3.History Report  4.Display Trans.  5.Last Receipt  6.Performance  7.Tip Report  8.Report Setup  9.RAMDISK Report</p>
3.	<b>Press [ENTER]</b> to select 1. Visa/MasterCard Setup	 <p><b>Report Setup</b>  1.Vis/Mastr Setp  2.Tip Discount</p>
4.	Use the [ <b>▲</b> ] and [ <b>▼</b> ] keys to select if you would like Visa and MasterCard printing together or separately then <b>press [ENTER].</b>  <i>OR</i> Press the number corresponding with your selection	 <p><b>Vis/Mastr Setup</b>  1.Separately  2.Together</p>
5.	<b>Stop.</b>	



## Report Setup – Tip Discount

**FUNCTION DESCRIPTION** This menu options allows the tip discount percentage to be set. This function applies to restaurant mode only. Tip Discount **must be enabled** in the individual tip areas to take affect.

STEP	ACTION	DISPLAY
1.	From the Main Menu, <b>press [1]</b> to access the Reports Menu. <b>Input the Password and press [ENTER].</b>	<b>MENU SCREEN:</b> 1.Reports 2.Merch. Params 3.Merch. Options 4.Hosts Params 5.System Options 6.Radio Params 7.Download 8.Communication 9.NOS Menu
2.	<b>Press [8]</b> to select Report Setup.	<b>REPORTS:</b> 1.Default Report 2.Current Report 3.History Report 4.Display Trans. 5.Last Receipt 6.Performance 7.Tip Report 8.Report Setup 9.RAMDISK Report
3.	Press <b>[ENTER]</b> to select 2. Tip Discount	<b>Report Setup</b> 1.Vis/Mastr Set 2.Tip Discount
4.	Use the <b>[▲]</b> and <b>[▼]</b> keys to scroll through the Card Type options then <b>press [ENTER]</b> to select.  <i>OR</i> Press the number corresponding with your selection.	<b>SELECT CARD TYPE</b> 1.ALL 2.VISA 3.MasterCard 4.AMEX 5.Diners 6.CarfeBlanch 7.Disc/NOVUS 8.enRoute 9.JCB
5.	<b>Input the percent (%) amount then press [ENTER]</b>  <b>Note:</b> Be sure whole percents are to the left of the decimal point.	<b>Tips % Discount</b>  0.00
6.	<b>Stop.</b>	

# RAM Disk Report

**FUNCTION DESCRIPTION** A report listing the record size and maximum number of transactions for each EDC type is printed via this function.

**NOTE:** This feature is available with POS\_PLUS application only.

STEP	ACTION	DISPLAY
1.	From the Main Menu, <b>press [1]</b> to access the Reports Menu. <b>Input the Password</b> and <b>press [ENTER]</b> .	<b>MENU SCREEN:</b> 1.Reports 2.Merch. Params 3.Merch. Options 4.Hosts Params 5.System Options 6.Radio Params 7.Download 8.Communication 9.NOS Menu
2.	<b>Press [9]</b> to select RAMDISK Report.	<b>REPORTS:</b> 1.Default Report 2.Current Report 3.History Report 4.Display Trans. 5.Last Receipt 6.Performance 7.Tip Report 8.Report Setup 9.RAMDISK Report
3.	The RAMDISK Report will print.	
4.	<b>Stop.</b>	

# Communication Log Report

**FUNCTION DESCRIPTION** Use this function to print a communication log of the last transaction or batch processed or to clear the log.

**NOTE:** This feature is available with POS\_PLUS application only.

STEP	ACTION	DISPLAY
1.	From the Main Menu, <b>press [1]</b> to access the Reports Menu. <b>Input the Password and press [ENTER].</b>	<b>MENU SCREEN:</b> 1.Reports 2.Merch. Params 3.Merch. Options 4.Hosts Params 5.System Options 6.Radio Params 7.Download 8.Communication 9.NOS Menu
2.	Use the [ <b>▼</b> ] key to scroll to menu option <b>10. ComLog Rprt</b> and then <b>press [ENTER].</b>	<b>REPORTS:</b> 2.Current Report 3.History Report 4.Display Trans. 5.Last Receipt 6.Performance 7.Tip Report 8.Report Setup 9.RAMDISK Report 10.ComLoa Rprt
3.	<b>Press [1]</b> to print the current communication log or <b>press [2]</b> to clear the communication log information.	<b>ComLog Report</b> 1.ComLog Print 2.ComLog Clear
4.	<b>Stop.</b>	

## 2. Merchant Parameters

This menu contains nine different functions that can be changed manually. They are:

- |                         |   |   |                                       |
|-------------------------|---|---|---------------------------------------|
| <b>MENU DESCRIPTION</b> | <input type="checkbox"/> Authorizations | <input type="checkbox"/> Security Level | <input type="checkbox"/> Edit Header  |
|                         | <input type="checkbox"/> Edit Trailer   | <input type="checkbox"/> Set Cash EDC   | <input type="checkbox"/> Merchant Fee |
|                         | <input type="checkbox"/> Set Batch Time | <input type="checkbox"/> Server/Invoice | <input type="checkbox"/> Site ID      |

### Authorizations – TRANSACTION TYPE

**FUNCTION DESCRIPTION** This function allows specific transaction types to be enabled and disabled. For example, Voids, Returns, Forced Sales, etc. can be turned off or on.

STEP	ACTION	DISPLAY
1.	From the Main MENU SCREEN <b>press [2]</b> to access Merchant Parameters	<b>MENU SCREEN:</b> 1.Reports 2.Merch. Params 3.Merch. Options 4.Hosts Params 5.System Options 6.Radio Params 7.Download 8.Communication 9.NOS Menu
2.	<b>Press [1]</b> to access Authorizations	<b>MERCHANT PARAMS</b> 1.Authorizations 2.Security Level 3.Edit Header 4.Edit Trailer 5.Set Cash EDC 6.Merchant Fee 7.Set Batch Time 8.Srvr/Clrk/Invoice 9. Site ID
3.	<b>Input the Password</b> and <b>press [ENTER]</b>	<b>ENTER PASSWORD:</b>
4.	<b>Press [1]</b> to edit authorization for Transaction Types.	<b>AUTHORIZATION</b> 1.Trans. Types 2.Card Types 3.Debit Prompt

*Continued on next page*

## Authorizations – Transaction Type, Continued

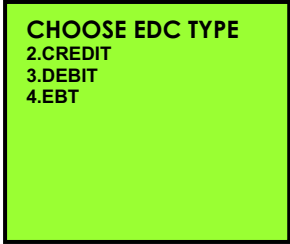
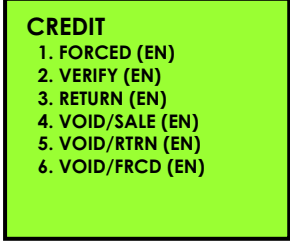
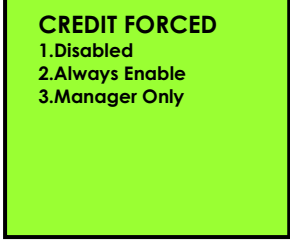
STEP	ACTION	DISPLAY
5.	<p>Use the [▲] and [▼] keys to scroll through the EDC Type options then <b>press [ENTER]</b> to select.</p> <p style="text-align: center;"><u>OR</u></p> <p><b>Press</b> the number corresponding with your selection.</p>	 <p><b>CHOOSE EDC TYPE</b> 2.CREDIT 3.DEBIT 4.EBT</p>
6.	<p>Use the [▲] and [▼] keys to select the Transaction Type then <b>press [ENTER]</b>.</p> <p style="text-align: center;"><u>OR</u></p> <p><b>Press</b> the number corresponding with your selection.</p>	 <p><b>CREDIT</b> 1. FORCED (EN) 2. VERIFY (EN) 3. RETURN (EN) 4. VOID/SALE (EN) 5. VOID/RTRN (EN) 6. VOID/FRCD (EN)</p>
7.	<p>Use the [▲] and [▼] keys to select Enable, Disable or Manager Only for the Transaction Type then <b>press [ENTER]</b>.</p> <p style="text-align: center;"><u>Or</u></p> <p><b>Press</b> the number corresponding with your selection</p>	 <p><b>CREDIT FORCED</b> 1.Disabled 2.Always Enable 3.Manager Only</p>
8.	<b>Stop.</b>	

## Authorizations – Card Type

### FUNCTION DESCRIPTION

This function allows specific card types to be enabled and disabled. For example, Visa, MasterCard, Discover, Amex, etc. can be turned off or on.

STEP	ACTION	DISPLAY
1.	From the Main MENU SCREEN <b>press [2]</b> to access Merchant Parameters	<b>MENU SCREEN:</b> 1.Reports 2.Merch. Params 3.Merch. Options 4.Hosts Params 5.System Options 6.Radio Params 7.Download 8.Communication 9.NOS Menu
2.	<b>Press [1]</b> to access Authorizations.	<b>MERCHANT PARAMS</b> 1.Authorizations 2.Security Level 3.Edit Header 4.Edit Trailer 5.Set Cash EDC 6.Merchant Fee 7.Set Batch Time 8. Srvr/Clrk/Invoice 9. Site ID
3.	<b>Input the Password</b> and <b>press [ENTER]</b> .	<b>ENTER PASSWORD:</b>
4.	<b>Press [2]</b> to edit authorization for Card Types.	<b>AUTHORIZATION</b> 1.Trans. Types 2.Card Types 3.Debit Prompt
5.	Use the [ <b>▲</b> ] and [ <b>▼</b> ] keys to scroll through the Card Type options then <b>press [ENTER]</b> to select.  <i>Or</i> <b>Press</b> the number corresponding with your selection	<b>Choose Card Typ</b> 1.VISA + 2.MasterCard + 3.AMEX + 4.Diners + 5.CarteBlanch + 6.Disc/NOVUS + 7.enRoute + 8.JCB +

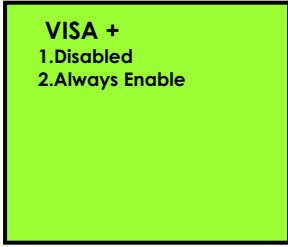

*Continued on next page*

## Authorizations – Card Type, Continued

STEP	ACTION	DISPLAY
6.	Use the [▲] and [▼] keys to select Enable or Disable for the Card Type then <b>press [ENTER]</b> .  <i>Or</i> <b>Press</b> the number corresponding with your selection	 <p>VISA + 1.Disabled 2.Always Enable</p> <p>'+' indicates enabled and '-' indicates disabled.</p>
7.	<b>Stop.</b>	

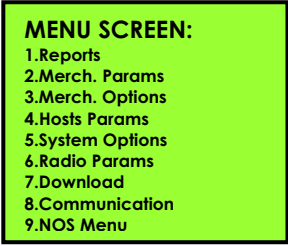

## Authorizations – Debit Prompt

**FUNCTION** This function prompts the user to choose CREDIT or DEBIT when a credit card is swiped and the payment type is CREDIT.  
**DESCRIPTION**

STEP	ACTION	DISPLAY
1.	From the Main MENU SCREEN <b>press [2]</b> to access Merchant Parameters	 <p><b>MENU SCREEN:</b> 1.Reports 2.Merch. Params 3.Merch. Options 4.Hosts Params 5.System Options 6.Radio Params 7.Download 8.Communication 9.NOS Menu</p>
2.	<b>Press [1]</b> to access Authorizations	 <p><b>MERCHANT PARAMS</b> 1.Authorizations 2.Security Level 3.Edit Header 4.Edit Trailer 5.Set Cash EDC 6.Merchant Fee 7.Set Batch Time 8 Srvr/Clrk/Invoice 9. Site ID</p>

*Continued on next page*

## Authorizations – Debit Prompt, Continued

STEP	ACTION	DISPLAY
3.	Input the <b>Password</b> and press <b>[ENTER]</b>	 <p>ENTER PASSWORD:</p>
4.	Press <b>[3]</b> to select 3. Debit Prompt	 <p>AUTHORIZATION 1.Trans. Types 2.Card Types 3.Debit Prompt</p>
5.	Press <b>[1]</b> to turn Debit Prompt OFF or press <b>[2]</b> to turn Debit Prompt ON.	 <p>DEBIT PROMPT 1.OFF 2.ON</p>
6.	<b>Stop.</b>	



## Security Levels

### FUNCTION DESCRIPTION

This option allows merchants to set security levels for the Main Menu, Batching, Card Security, Manual Entry of a credit card, and printing format of a credit card number.



STEP	ACTION	DISPLAY
1.	From the Main MENU SCREEN <b>press [2]</b> to access Merchant Parameters	<b>MENU SCREEN:</b> 1.Reports 2.Merch. Params 3.Merch. Options 4.Hosts Params 5.System Options 6.Radio Params 7.Download 8.Communication 9.NOS Menu
2.	<b>Press [2]</b> to access Security Level	<b>MERCHANT PARAMS</b> 1.Authorization 2.Security Level 3.Edit Header 4.Edit Trailer 5.Set Cash EDC 6.Merchant Fee 7.Set Batch Time 8. Srvr/Clrk/Invoice 9. Site ID
3.	Use the [ <b>▲</b> ] and [ <b>▼</b> ] keys to select the option you are editing security for and then <b>press [ENTER]</b> . <i>Or</i> <b>Press</b> the number corresponding with your selection	<b>SECURITY SWITCH</b> 1.Menu 2.Batch 3.Print Account 4.Secure Card 5.Crd Man. Entry
4.	Use the [ <b>▲</b> ] and [ <b>▼</b> ] keys to Enable the function or set security to Manager Only then <b>press [ENTER]</b> . <i>Or</i> <b>Press</b> the number corresponding with your selection	<b>Batch:</b> 1.Always Enable 2.Manager Only
5.	<b>Stop.</b>	

FUNCTION	OPTIONS
Menu	Always Enabled and Manager Only
Batch	Always Enabled and Manager Only
Print Account	Always Full, Full on Report and Always Short
Secure Card	No Security, Last 4 Digits and All Digits
Card Manual Entry (Password Protected)	Disabled and Always Enabled

## Edit Header/Trailer

### FUNCTION DESCRIPTION

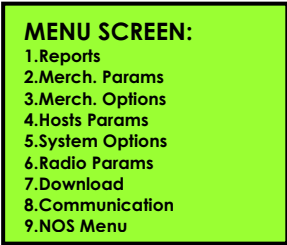
The receipt header and trailer can be changed manually through the terminal. A specific line, character, or entire header/trailer can be changed, if needed. Both Header and Trailer are composed of five lines, 24 characters per line.

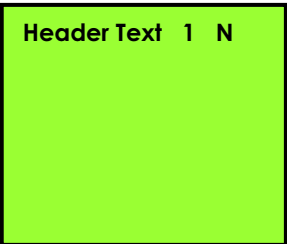
STEP	ACTION	DISPLAY
1.	From the Main MENU SCREEN <b>press [2]</b> to access Merchant Parameters	
2.	<p><b>Press [3]</b> to Edit the Receipt Header</p> <p><i>Or</i></p> <p><b>Press [4]</b> to Edit the Receipt Trailer</p>	
3.	<b>Input</b> in the <b>text</b> that you want printed out on the receipt. (See instructions below)	
4.	<p>To change the letters, first press the number key that corresponds with the desired letter then press the <b>[ALPHA]</b> key and the <b>[F]</b> key simultaneously to cycle through the other characters also on that key</p> <p><i>For example:</i></p> <p>The <b>#2</b> key on the keypad also has the letters <b>A</b>, <b>B</b> and <b>C</b> printed on it. When you first press this key, the display will show the number <b>2</b>, by pressing the <b>[ALPHA]</b> key and the <b>[F]</b> key simultaneously it will cause the display to change from <b>2</b> to the letter <b>A</b>, press <b>[ALPHA]</b> and <b>[2]</b> again and then it becomes a <b>B</b> and finally <b>C</b> before starting all over again back to the number <b>2</b>.</p>	
5.	<p><b>Press and hold</b> the <b>[F]</b> key then <b>tap</b> the <b>[9]</b> to move the cursor to the right.</p> <p><b>Press and hold</b> the <b>[F]</b> key then <b>tap</b> the <b>[8]</b> to move the cursor to the left.</p> <p><b>Press [▼]</b> to scroll to the next line.</p>	

Continued on next page.

## Edit Header/Trailer, Continued

---

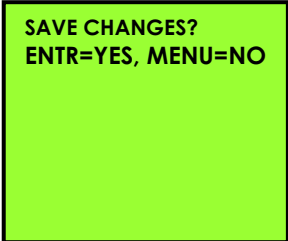
STEP	ACTION	DISPLAY
6.	When all information has been entered/edited <b>press [MENU]</b> to complete process.  If prompted, <b>press [ENTER]</b> to save your changes.	
7.	<b>Stop.</b>	

# Set Cash EDC

## FUNCTION DESCRIPTION

Cash will be an addition to your Payment Modes, and will record cash transactions when this option is enabled. No batching or transfer of money is part of this process. Cash EDC is used only to track cash transactions.

STEP	ACTION	DISPLAY
1.	From the Main MENU SCREEN <b>press [2]</b> to access Merchant Parameters	<b>MENU SCREEN:</b> 1.Reports 2.Merch. Params 3.Merch. Options 4.Hosts Params 5.System Options 6.Radio Params 7.Download 8.Communication 9.NOS Menu
2.	<b>Press [5]</b> to Set Cash EDC	<b>MERCHANT PARAMS</b> 1.Authorization 2.Security Level 3.Edit Header 4.Edit Trailer 5.Set Cash EDC 6.Merchant Fee 7.Set Batch Time 8. Srvr/Clrk/Invoice 9. Site ID
3.	<b>Input the Password</b> and <b>press [ENTER]</b>	<b>ENTER PASSWORD:</b>
4.	<b>Press [1]</b> to Set EDC With Cash <i>Or</i> <b>Press [2]</b> to Set EDC Without Cash	<b>CASH EDC SET:</b> 1.WITH CASH 2.WITHOUT CASH
5.	<b>Stop.</b>	

## Setting the Merchant Fee

**FUNCTION** Use this function to add a Merchant Fee to a debit transaction.  
**DESCRIPTION**

STEP	ACTION	DISPLAY
1.	From the Main MENU SCREEN <b>press [2]</b> to access Merchant Parameters	<b>MENU SCREEN:</b> 1.Reports 2.Merch. Params 3.Merch. Options 4.Hosts Params 5.System Options 6.Radio Params 7.Download 8.Communication 9.NOS Menu
2.	<b>Press [6]</b> for Merchant Fee.	<b>MERCHANT PARAMS</b> 1.Authorization 2.Security Level 3.Edit Header 4.Edit Trailer 5.Set Cash EDC 6.Merchant Fee 7.Set Batch Time 8. Svr/Clrk/Invoice 9. Site ID
3.	<b>Input the Password and press [ENTER]</b>	<b>ENTER PASSWORD:</b>
4.	<b>Input the Merchant Fee then press [ENTER]</b>	<b>Merch Fee: \$0.00</b> <b>New Rate: 0.00</b>
5.	<b>Press [ENTER]</b>	<b>ARE YOU SURE</b> <b>ENTR=YES, MENU=NO</b>

*Continued on next page*

## Setting the Merchant Fee, Continued

STEP	ACTION	DISPLAY
6.	Press <b>[ENTER]</b> to add fee to CashBack transactions only or <b>[MENU]</b> to add fee to all debit transactions.	<div style="border: 1px solid black; background-color: #90EE90; padding: 5px;"> <p>On CashBack Only ENTR=YES, MENU=NO</p> </div>
7.	<b>Stop.</b>	

## Set Batch Time

### FUNCTION DESCRIPTION

This option will allow the batch time in the terminal to be set for a specific time. This is used on AUTOBATCH terminals only. Set Batch Time will print a batch report and will not actually dial to batch.

STEP	ACTION	DISPLAY
1.	From the Main MENU SCREEN press <b>[2]</b> to access Merchant Parameters	<div style="border: 1px solid black; background-color: #90EE90; padding: 5px;"> <p><b>MENU SCREEN:</b>            1.Reports            2.Merch. Params            3.Merch. Options            4.Hosts Params            5.System Options            6.Radio Params            7.Download            8.Communication            9.NOS Menu</p> </div>
2.	Press <b>[7]</b> to set the Autobatch Batch Time	<div style="border: 1px solid black; background-color: #90EE90; padding: 5px;"> <p><b>MERCHANT PARAMS</b>            1.Authorizations            2.Security Level            3.Edit Header            4.Edit Trailer            5.Set Cash EDC            6.Merchant Fee            7.Set Batch Time            8 Srvr/Clrk/Invoice            9. Site ID</p> </div>
3.	Input the <b>Password</b> and press <b>[ENTER]</b>	<div style="border: 1px solid black; background-color: #90EE90; padding: 5px;"> <p><b>ENTER PASSWORD:</b></p> </div>

Continued on next page

## Set Batch Time, Continued

---

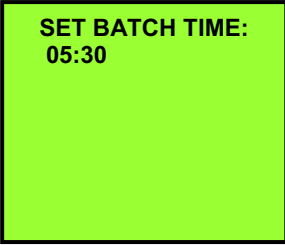



STEP	ACTION	DISPLAY
4.	<b>Input the desired time in military time (24 hour) and press [ENTER]</b>	
5.	If the terminal was programmed with more than one Autobatch EDC, you will be prompted to choose host before setting the batch time.	
6.	<b>Stop.</b>	

## Server ID/Clerk ID/Invoice Mode

### FUNCTION DESCRIPTION

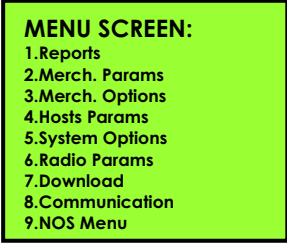
This will allow the terminal to prompt for a server/clerk ID, invoice number, or both. For Retail terminals with no Tip active, the function is Clerk ID. For a Retail terminal with at least one Tip active or a Restaurant terminal, the function is Server ID.

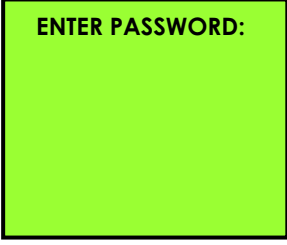
If Server/Clerk ID Mode is activated, up to 100 ID/name designations can be entered and stored in the terminal. When storing the number/name designations, the server numbers are restricted to from 1 to 100.

STEP	ACTION	DISPLAY
1.	From the Main MENU SCREEN <b>press [2]</b> to access Merchant Parameters	 <p><b>MENU SCREEN:</b>  1.Reports  2.Merch. Params  3.Merch. Options  4.Hosts Params  5.System Options  6.Radio Params  7.Download  8.Communication  9.NOS Menu</p>
2.	<b>Press [8]</b> for Server/Invoice Mode.	 <p><b>MERCHANT PARAMS</b>  1.Authorization  2.Security Level  3.Edit Header  4.Edit Trailer  5.Set Cash EDC  6.Merchant Fee  7.Set Batch Time  8. Srvr/Clrk/Invoice  9. Site ID</p>
3.	<b>Input the Password</b> and <b>press [ENTER]</b>	 <p><b>ENTER PASSWORD:</b></p>
4.	Use the [ <b>▲</b> ] and [ <b>▼</b> ] keys to select <i>OFF</i> or <i>ON</i> and then <b>press [ENTER]</b> .  <i>Or</i> <b>Press</b> the number corresponding with your selection.	 <p><b>SERVER ID MODE:</b>  1.OFF  2.ON</p> <p><b>NOTE:</b> Display will change to reflect Retail or Restaurant configuration.</p>

Continued on next page.



## Server ID/Clerk ID/Invoice Mode, Continued

STEP	ACTION	DISPLAY
5.	<p>Enter the Server ID number a name is to be assigned to then <b>press [ENTER]</b>.</p> <p><i>Or</i></p> <p>Press <b>[MENU]</b> to bypass.</p>	<div style="border: 1px solid black; background-color: #90EE90; padding: 5px;"> <p><b>SERVER ID MODE:</b> 1.OFF 2.ON</p> </div> <div style="border: 1px solid black; background-color: #90EE90; padding: 5px;"> <p><b>ENTER SERVER ID</b> 1</p> </div>
6.	<p>Using the method described in Editing Header, <b>enter</b> the 19-character name. <b>Press [ENTER]</b> when the name has been entered.</p>	<div style="border: 1px solid black; background-color: #90EE90; padding: 5px;"> <p>Srv #1 Name: 1 N</p> </div>
7.	<p>Continue in this manner until all server names have been entered. <b>Press [MENU]</b> to accept the entered names and continue to Invoice Mode.</p>	<div style="border: 1px solid black; background-color: #90EE90; padding: 5px;"> <p>Srv #14 Name: 1 N ALICE</p> </div> <div style="border: 1px solid black; background-color: #90EE90; padding: 5px;"> <p><b>ENTER SERVER ID</b> 15</p> </div>
8.	<p>Use the [<b>▲</b>] and [<b>▼</b>] keys to select <i>OFF</i> or <i>ON</i> then <b>press [ENTER]</b>.</p> <p><i>Or</i></p> <p><b>Press</b> the number corresponding with your selection.</p>	<div style="border: 1px solid black; background-color: #90EE90; padding: 5px;"> <p><b>INVOICE MODE:</b> 1.OFF 2.ON</p> </div>
9.	<p><b>Note:</b> <i>In the Restaurant application, there are two more options after Invoice; Table #'s and Guest #'s.</i></p>	
10.	<b>Stop.</b>	

## Site ID

**FUNCTION DESCRIPTION** This option is used mainly for programming purposes, it allows customer service to view, or change the terminal number.

STEP	ACTION	DISPLAY
1.	From the Main MENU SCREEN <b>press [2]</b> to access Merchant Parameters	<b>MENU SCREEN:</b> 1.Reports 2.Merch. Params 3.Merch. Options 4.Hosts Params 5.System Options 6.Radio Params 7.Download 8.Communication 9.NOS Menu
2.	<b>Press [9]</b> to access Site ID	<b>MERCHANT PARAMS</b> 1.Authorization 2.Security Level 3.Edit Header 4.Edit Trailer 5.Set Cash EDC 6.Merchant Fee 7.Set Batch Time 8.Server ID/Invoice 9. Site ID
3.	The UNIQUE and current Site ID used to program the terminal will display. <b>Press [ENTER]</b> to change the ID.	<b>CHANGE SITE ID?</b> <b>0000100</b>
4.	<b>Input the Password and Press [ENTER]</b>	<b>ENTER PASSWORD:</b>
5.	<b>Enter the new Site ID then press [ENTER].</b>	<b>Enter Site ID</b>
6.	<b>Stop.</b>	

### 3. Merchant Options

This Main Menu has fifteen options that can be enabled or disabled manually through the terminal.

<b>MENU DESCRIPTION</b>	<input type="checkbox"/> Paper Type	<input type="checkbox"/> No-Paper Mode	<input type="checkbox"/> Buzzer Set	<input type="checkbox"/> Operation Mode
	<input type="checkbox"/> Battery Saver	<input type="checkbox"/> Print Disclaimer	<input type="checkbox"/> Set Menu Type	<input type="checkbox"/> Set Halo
	<input type="checkbox"/> Print Setup	<input type="checkbox"/> Store & Forward	<input type="checkbox"/> Check Reader	<input type="checkbox"/> Sign Option *
	<input type="checkbox"/> Bridge Comm *		<input type="checkbox"/> Language Setup *	

**\*NOTE:** These features are available with the POS\_PLUS application only.

### Paper Type

**FUNCTION DESCRIPTION** This option sets the paper type to single ply, double ply, or customized. Single ply prints two receipts (for credit by default, also for debit and EBT if specified in the terminal file), double ply prints one receipt (with account truncation) and customized prints two receipts for all payment modes.

STEP	ACTION	DISPLAY
1.	From the Main Menu <b>Press [3]</b> to access Merchant Options	<div style="border: 1px solid black; background-color: #90EE90; padding: 5px;"> <b>MENU SCREEN:</b>                      1.Reports                      2.Merch. Params                      3.Merch. Options                      4.Hosts Params                      5.System Options                      6.Radio Params                      7.Download                      8.Communication                      9.NOS Menu                 </div>
2.	<b>Press [ENTER]</b> for Paper Type	<div style="border: 1px solid black; background-color: #90EE90; padding: 5px;"> <b>MERCH. OPTIONS</b>                      1.Paper Type                      2.No-Paper Mode                      3.Buzzer Set                      4.Operation Mode                      5.Battery Saver                      6.Prt Disclaimer                      7.Set Menu Type                      8.Set Halo                      9.Print Setup                 </div>
3.	Use the [ <b>▲</b> ] and [ <b>▼</b> ] keys to highlight your selection and then press [ <b>ENTER</b> ].  <i>Or</i> <b>Press</b> the number corresponding with your selection.	<div style="border: 1px solid black; background-color: #90EE90; padding: 5px;"> <b>PAPER TYPE</b>                      1.Single Ply                      2.Double Ply                      3.Customized                 </div>
4.	<b>Stop.</b>	

# Buzzer Set

**FUNCTION  
DESCRIPTION**

Enables or disables tone when performing certain terminal functions.

STEP	ACTION	DISPLAY
1.	From the Main Menu <b>Press [3]</b> to access Merchant Options	<b>MENU SCREEN:</b> 1.Reports 2.Merch. Params 3.Merch. Options 4.Hosts Params 5.System Options 6.Radio Params 7.Download 8.Communication 9.NOS Menu
2.	<b>Press [3]</b> for Buzzer Set	<b>MERCH. OPTIONS</b> 1.Paper Type 2.No-Paper Mode 3.Buzzer Set 4.Operation Mode 5.Battery Saver 6.Prt Disclaimer 7.Set Menu Type 8.Set Halo 9.Print Setup
3.	Use the [ <b>▲</b> ] and [ <b>▼</b> ] keys to your selection and then press [ <b>ENTER</b> ].  <i>Or</i> <b>Press</b> the number corresponding with your selection.	<b>BUZZER SET:</b> 1.OFF 2.ON
4.	<b>Stop.</b>	

# Operation Mode

**FUNCTION  
DESCRIPTION**

This option allows the terminal to be set at two different modes, Normal or Demo (Demo mode for training; Normal mode for live transactions). If the terminal is set in Demo mode for training purposes, you must **revert back** to **Normal** mode for **live** transactions.

STEP	ACTION	DISPLAY
1.	From the Main Menu <b>Press [3]</b> to access Merchant Options	<b>MENU SCREEN:</b> 1.Reports 2.Merch. Params 3.Merch. Options 4.Hosts Params 5.System Options 6.Radio Params 7.Download 8.Communication 9.NOS Menu
2.	<b>Press [4]</b> for Operation Mode	<b>MERCH. OPTIONS</b> 1.Paper Type 2.No-Paper Mode 3.Buzzer Set 4.Operation Mode 5.Battery Saver 6.Prt Disclaimer 7.Set Menu Type 8.Set Halo 9.Print Setup
3.	Use the [ <b>▲</b> ] and [ <b>▼</b> ] keys to your selection and then press [ <b>ENTER</b> ].  <i>Or</i> <b>Press</b> the number corresponding with your selection.	<b>OPERATION MODE:</b> 1.Demo Mode 2.Normal Mode
4.	<b>Press [ENTER]</b> to execute change.	<b>ARE YOU SURE?</b> <b>ENTR=YES, MENU=NO</b>
5.	<b>Stop.</b>	

# Battery Saver

**FUNCTION DESCRIPTION**

This option puts terminal in a standby mode. It can be enabled or disabled.

STEP	ACTION	DISPLAY
1.	From the Main Menu <b>Press [3]</b> to access Merchant Options	<b>MENU SCREEN:</b> 1.Reports 2.Merch. Params 3.Merch. Options 4.Hosts Params 5.System Options 6.Radio Params 7.Download 8.Communication 9.NOS Menu
2.	<b>Press [5]</b> for Battery Saver	<b>MERCH. OPTIONS</b> 1.Paper Type 2.No-Paper Mode 3.Buzzer Set 4.Operation Mode 5.Battery Saver 6.Prt Disclaimer 7.Set Menu Type 8.Set Halo 9.Print Setup
3.	Use the [ <b>▲</b> ] and [ <b>▼</b> ] keys to your selection and then <b>press [ENTER]</b> .  <i>Or</i> <b>Press</b> the number corresponding with your selection.	<b>BATT SAVER ~ ON</b> 1. OFF 2. Auto Off Only 3. Radio Only 4. Radio+Auto Off
4.	<b>Press [ENTER]</b> to execute change.	<b>ARE YOU SURE?</b> <b>ENTR=YES, MENU=NO</b>
5.	<b>Input the seconds</b> that should elapse prior to the battery saver being initiated.  Then press <b>[ENTER]</b>	<b>IDLE TIME: [sec]</b> <b>60</b>
6.	<b>Stop.</b>	

*Continued on next page.*

## Battery Saver, Continued

---

OPTION	DEFINITION
<b>Off</b>	This option turns the battery saver off.
<b>Radio Only</b>	This option will shut off only the radio after a specific amount of time is set in terminal.
<b>Radio + Auto Off</b>	This shuts the radio and terminal off after a specific amount of time set in terminal.
<b>Auto Off Only</b>	With this option only the terminal will shut off after a specific amount of time set in the terminal. The Radio will stay on.

---

# Prints Disclaimer

This option will print the following statement at the end of a credit card transaction:

**FUNCTION  
DESCRIPTION**

**"I AGREE TO PAY ABOVE TOTAL AMOUNT ACCORDING TO CARD ISSUER AGREEMENT (MERCHANT AGREEMENT IF CREDIT VOUCHER)."**

STEP	ACTION	DISPLAY
1.	From the Main Menu <b>Press [3]</b> to access Merchant Options.	<b>MENU SCREEN:</b> 1.Reports 2.Merch. Params 3.Merch. Options 4.Hosts Params 5.System Options 6.Radio Params 7.Download 8.Communication 9.NOS Menu
2.	<b>Press [6]</b> for Print Disclaimer.	<b>MERCH. OPTIONS</b> 1.Paper Type 2.No-Paper Mode 3.Buzzer Set 4.Operation Mode 5.Battery Saver 6.Prt Disclaimer 7.Set Menu Type 8.Set Halo 9.Print Setup
3.	<b>Press [1]</b> to turn the Disclaimer Off <b>Or</b> <b>Press [2]</b> to turn the Disclaimer On	<b>PRT DSCLMR1 MODE</b> 1.OFF 2.ON
4.	<b>Stop.</b>	



# Set Menu Type

## FUNCTION DESCRIPTION

The menu in the terminal can be set to scroll automatically, or manually.

STEP	ACTION	DISPLAY
1.	From the Main Menu <b>Press [3]</b> to access Merchant Options	<div style="border: 1px solid black; background-color: #90EE90; padding: 5px;"> <b>MENU SCREEN:</b>            1.Reports            2.Merch. Params            3.Merch. Options            4.Hosts Params            5.System Options            6.Radio Params            7.Download            8.Communication            9.NOS Menu         </div>
2.	<b>Press [7]</b> to Set Menu Type	<div style="border: 1px solid black; background-color: #90EE90; padding: 5px;"> <b>MERCH. OPTIONS</b>            1.Paper Type            2.No-Paper Mode            3.Buzzer Set            4.Operation Mode            5.Battery Saver            6.Prt Disclaimer            7.Set Menu Type            8.Set Halo            9.Print Setup         </div>
3.	Use the [ <b>▲</b> ] and [ <b>▼</b> ] keys to find your selection and then <b>press [ENTER]</b> .  <i>Or</i> <b>Press</b> the number corresponding with your selection.	<div style="border: 1px solid black; background-color: #90EE90; padding: 5px;"> <b>CHOOSE MENU TYPE</b>            1.Auto Scroll            2.Manual Scroll         </div>
4.	<b>Note:</b> If auto scroll is selected the terminal will prompt you for scroll speed (1/fastest-9/slowest). <b>Type in a speed and press [ENTER]</b> .	
5.	<b>Stop.</b>	

# Set Halo

**FUNCTION DESCRIPTION** This option sets a limit that cannot be exceeded. This option can be set for sales, refunds, and/or cash back.

STEP	ACTION	DISPLAY
1.	From the Main Menu <b>press [3]</b> to access Merchant Options.	<b>MENU SCREEN:</b> 1.Reports 2.Merch. Params 3.Merch. Options 4.Hosts Params 5.System Options 6.Radio Params 7.Download 8.Communication 9.NOS Menu
2.	<b>Press [8]</b> to Set Halo.	<b>MERCH. OPTIONS</b> 1.Paper Type 2.No-Paper Mode 3.Buzzer Set 4.Operation Mode 5.Battery Saver 6.Pri Disclaimer 7.Set Menu Type 8.Set Halo 9.Print Setup
3.	<b>Input the Password and Press [ENTER]</b>	<b>ENTER PASSWORD:</b>
4.	Use the [ <b>▲</b> ] and [ <b>▼</b> ] keys to find your selection and then <b>press [ENTER]</b> .  <i>Or</i> <b>Press</b> the number corresponding with your selection  <b>Note:</b> If option 1 is selected, continue with step 6.	<b>HALO FOR SALE:</b> 1.OFF 2.ON
5.	Input the maximum amount for a sale then <b>press [ENTER]</b> .	<b>HALO: \$0.00</b> <b>NEW RATE: \$0.00</b>

Continued on next page

## Set Halo, Continued

---

STEP	ACTION	DISPLAY
6.	Repeat steps 4 and 5 for Return Halo and Cash Back Halo.	
7.	<b>Stop.</b>	

# Print Setup

**FUNCTION  
DESCRIPTION**

This option will print a setup report. It will show application information, the terminal header and trailer, signature capture mode if enabled, list all card types showing enabled (+) or disabled (-), menu security, card security, paper type, merchant fee, PIN pad information, server mode, invoice mode, report setup, HALO settings working mode information, comment line, transaction type settings and the Hot Key list.

STEP	ACTION	DISPLAY
1.	From the Main Menu <b>Press [3]</b> to access Merchant Options	<div style="border: 1px solid black; background-color: #90EE90; padding: 5px;"> <p><b>MENU SCREEN:</b></p> <ul style="list-style-type: none"> <li>1.Reports</li> <li>2.Merch. Params</li> <li>3.Merch. Options</li> <li>4.Hosts Params</li> <li>5.System Options</li> <li>6.Radio Params</li> <li>7.Download</li> <li>8.Communication</li> <li>9.NOS Menu</li> </ul> </div>
2.	<b>Press [9]</b> to Print the terminal Setup	<div style="border: 1px solid black; background-color: #90EE90; padding: 5px;"> <p><b>MERCH. OPTIONS</b></p> <ul style="list-style-type: none"> <li>1.Paper Type</li> <li>2.No-Paper Mode</li> <li>3.Buzzer Set</li> <li>4.Operation Mode</li> <li>5.Battery Saver</li> <li>6.Prt Disclaimer</li> <li>7.Set Menu Type</li> <li>8.Set Halo</li> <li>9.Print Setup</li> </ul> </div>
3.	<b>Input the Password and press [ENTER].</b>	<div style="border: 1px solid black; background-color: #90EE90; padding: 5px;"> <p><b>ENTER PASSWORD:</b></p> </div>
4.	<b>Stop.</b>	

## Store & Forward

Store & Forward (Offline Mode) will give the following six different options:

<b>FUNCTION</b>	<input type="checkbox"/> Mode Select	<input type="checkbox"/> Display Transactions
<b>DESCRIPTION</b>	<input type="checkbox"/> Reports	<input type="checkbox"/> Upload Transactions
	<input type="checkbox"/> Resend Failed	<input type="checkbox"/> Delete Failed

## Turning Store & Forward On/Off



STEP	ACTION	DISPLAY
1.	From the Main Menu <b>Press [3]</b> to access Merchant Options	<b>MENU SCREEN:</b> 1.Reports 2.Merch. Params 3.Merch. Options 4.Hosts Params 5.System Options 6.Radio Params 7.Download 8.Communication 9.NOS Menu
2.	Use the [ <b>▼</b> ] key to scroll to menu option <b>10. Store &amp; Forward</b> and then <b>press [ENTER]</b> .	<b>MERCH. OPTIONS:</b> 2.No-Paper Mode 3.Buzzer Set 4.Operation Mode 5.Battery Saver 6.Prt Disclaimer 7.Set Menu Type 8.Set Halo 9.Print Setup 10.Store&Forward
3.	<b>Input the Password and Press [ENTER]</b>	<b>ENTER PASSWORD:</b>
4.	<b>Press [1]</b> for S&F On/Off	<b>STORE&amp;FORWARD</b> 1.S&F On/Off 2.Mode Select 3.Display Trans 4.Reports 5.Upload Transct 6.Resend Failed 7.Delete Failed

*Continued on next page*

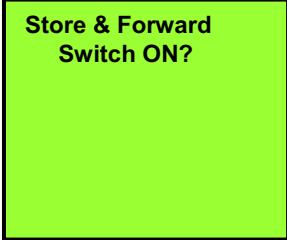
## Turning Store & Forward On/Off, Continued

STEP	ACTION	DISPLAY
5.	If Store & Forward is ON, <b>[ENTER]</b> will turn it OFF. If Store & Forward is OFF, <b>[ENTER]</b> will turn it ON.	
6.	<b>Stop.</b>	

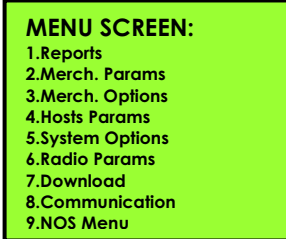
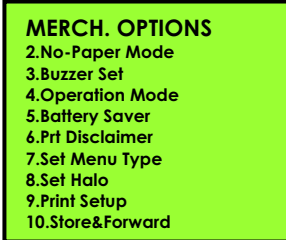
## Mode Select

STEP	ACTION	DISPLAY
1.	From the Main Menu <b>Press [3]</b> to access Merchant Options	
2.	Use the <b>[▼]</b> key to scroll to menu option <b>10. Store &amp; Forward</b> and then <b>press [ENTER]</b> .	
3.	<b>Input the Password and Press [ENTER]</b>	

*Continued on next page*

## Mode Select, Continued

STEP	ACTION	DISPLAY
4.	Press [2] for Mode Select.	<b>STORE&amp;FORWARD</b> 1.S&F On/Off 2.Mode Select 3.Display Trans 4.Reports 5.Upload Transct 6.Resend Failed 7.Delete Failed
5.	Use the [▲] and [▼] keys to find your selection and then <b>press [ENTER]</b> .  <i>Or</i> Press the number corresponding with your selection.  <b>NOTE:</b> See list of definitions on next page.	<b>MODE SELECT:</b> 1.Stay Online 2.Stay Offline 3.Off Until Btch 4.OfflineOnDmnd
6.	Press [ENTER]	<b>LIMIT PER CARD ?</b> <b>Accept?ENTER=Yes</b>
7.	Enter the maximum amount to be accepted for all Visa transactions then <b>press [ENTER]</b> . For no limit, <b>press [ENTER]</b> with no max amount entered.	<b>ENTER MAX AMOUNT</b> <b>VISA                    0.00</b>
8.	Continue for all credit card types.	
9.	Enter the maximum amount to be accepted for all transactions in total then <b>press [ENTER]</b> . For no limit, <b>press [ENTER]</b> with no max amount entered.	<b>ENTER MAX TOTAL</b> <b>                             0.00</b>
10.	A report listing the individual card and total limit will be printed.	
11.	<b>Stop.</b>	

Continued on next page.

## Mode Select, Continued

---

OPTION	DEFINITION
<b>STAY ONLINE</b>	The Terminal will process transactions only via radio/CDPD signal or phone line
<b>STAY OFFLINE</b>	The Terminal will process transactions via Offline only, it will not look for signal or phone line.
<b>OFF UNTIL BATCH</b>	The Terminal will process transactions via Offline only. When the <b>[BATCH]</b> key is pressed, the terminal will switch to Online and transmit all the transactions.
<b>OFFLINE ON DEMAND</b>	Terminal will process via Online. If no radio/CDPD signal is obtained, and no phone line is connected, the terminal will prompt: <b>RETRY OR PROCESS OFFLINE?</b>

---



# Display Transactions

**FUNCTION DESCRIPTION** Allows you to view "STORED" or "FAILED" transactions, by scrolling through all transactions, by transaction# OR server# (if server mode is on).

STEP	ACTION	DISPLAY
1.	From the Main Menu <b>Press [3]</b> to access Merchant Options	<b>MENU SCREEN:</b> 1.Reports 2.Merch. Params 3.Merch. Options 4.Hosts Params 5.System Options 6.Radio Params 7.Download 8.Communication 9.NOS Menu
2.	Use the [ <b>▼</b> ] key to scroll to menu option <b>10. Store &amp; Forward</b> and then <b>press [ENTER]</b> .	<b>MERCH. OPTIONS</b> 2.No-Paper Mode 3.Buzzer Set 4.Operation Mode 5.Battery Saver 6.Prt Disclaimer 7.Set Menu Type 8.Set Halo 9.Print Setup 10.Store&Forward
3.	<b>Input the Password and Press [ENTER]</b>	<b>ENTER PASSWORD:</b>
4.	<b>Press [3]</b> for Display Trans	<b>STORE&amp;FORWARD</b> 1.S&F On/Off 2.Mode Select 3.Display Trans 4.Reports 5.Upload Transct 6.Resend Failed 7.Delete Failed

*Continued on next page*

## Display Transactions, Continued

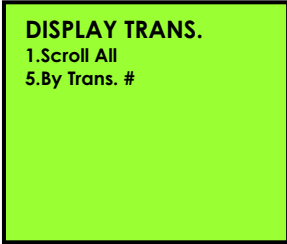
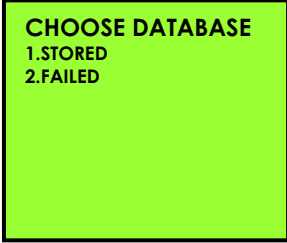
STEP	ACTION	DISPLAY
5.	Use the [▲] and [▼] keys to find your selection and then <b>press [ENTER]</b> .  <i>Or</i>  <b>Press</b> the number corresponding with your selection.	 <p><b>DISPLAY TRANS.</b> 1.Scroll All 5.By Trans. #</p>
6.	Use the [▲] and [▼] keys to find your selection and then <b>press [ENTER]</b> .  <i>Or</i>  <b>Press</b> the number corresponding with your selection.	 <p><b>CHOOSE DATABASE</b> 1.STORED 2.FAILED</p>
7.	<b>Stop.</b>	

## Reports – Store & Forward

**FUNCTION DESCRIPTION** There are three options for Store & Forward Reports:  
 1. Print Status     2. Print Offline     3. Print Failed

STEP	ACTION	DISPLAY
1.	From the Main Menu <b>Press [3]</b> to access Merchant Options	<b>MENU SCREEN:</b> 1.Reports 2.Merch. Params 3.Merch. Options 4.Hosts Params 5.System Options 6.Radio Params 7.Download 8.Communication 9.NOS Menu
2.	Use the [ <b>▼</b> ] key to scroll to menu option <b>10. Store &amp; Forward</b> and then <b>press [ENTER]</b> .	<b>MERCH. OPTIONS</b> 2.No-Paper Mode 3.Buzzer Set 4.Operation Mode 5.Battery Saver 6.Prt Disclaimer 7.Set Menu Type 8.Set Halo 9.Print Setup 10.Store&Forward
3.	<b>Input the Password</b> and <b>Press [ENTER]</b>	<b>ENTER PASSWORD:</b>
4.	<b>Press [4]</b> for Reports	<b>STORE&amp;FORWARD</b> 1.S&F On/Off 2.Mode Select 3.Display Trans 4.Reports 5.Upload Transct 6.Resend Failed 7.Delete Failed

*Continued on next page*

## Reports – Store & Forward, Continued

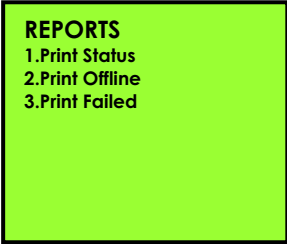
STEP	ACTION	DISPLAY
5.	<p>Use the [▲] and [▼] keys to find your selection and then <b>press [ENTER]</b>.</p> <p style="text-align: center;"><i>Or</i></p> <p><b>Press</b> the number corresponding with your selection.</p> <p><b>Note:</b> See option Definitions below.</p>	
6.	<b>Stop.</b>	

OPTION	DEFINITION
<b>Print Status</b>	A print out of the terminal's status, i.e.: Offline Mode or Online Mode.
<b>Print Offline</b>	A report of all transactions entered into the database in Offline Mode.
<b>Print Failed</b>	A report of all transactions that failed and were stored.

# Upload Transactions

**FUNCTION DESCRIPTION** This function allows you to upload all Offline transactions one by one, or all at once. If any transactions have failed the terminal will prompt: **PRINT FAILED TRANS?**

STEP	ACTION	DISPLAY
1.	From the Main Menu <b>Press [3]</b> to access Merchant Options	<b>MENU SCREEN:</b> 1.Reports 2.Merch. Params 3.Merch. Options 4.Hosts Params 5.System Options 6.Radio Params 7.Download 8.Communication 9.NOS Menu
2.	Use the [▼] key to scroll to menu option <b>10. Store &amp; Forward</b> and then <b>press [ENTER]</b> .	<b>MERCH. OPTIONS</b> 2.No-Paper Mode 3.Buzzer Set 4.Operation Mode 5.Battery Saver 6.Pri Disclaimer 7.Set Menu Type 8.Set Halo 9.Print Setup 10.Store&Forward
3.	<b>Input the Password and Press [ENTER]</b>	<b>ENTER PASSWORD:</b>
4.	<b>Press [5]</b> to Upload Transactions	<b>STORE&amp;FORWARD</b> 1.S&F On/Off 2.Mode Select 3.Display Trans 4.Reports 5.Upload Transct 6.Resend Failed 7.Delete Failed
5.	<b>Press [MENU]</b> to upload individual transactions  <b>Or</b>  <b>Press [ENTER]</b> to upload all offline transactions	<b>UPLOAD TRANSC</b> <b>ONE=MENU ALL=ENT</b>
6.	Terminal will contact the host, receive response and print receipts.	
7.	<b>Stop.</b>	

## Resend Failed Transactions

**FUNCTION  
DESCRIPTION**

This function allows you to resend any failed transactions.

STEP	ACTION	DISPLAY
1.	From the Main Menu <b>Press [3]</b> to access Merchant Options	<b>MENU SCREEN:</b> 1.Reports 2.Merch. Params 3.Merch. Options 4.Hosts Params 5.System Options 6.Radio Params 7.Download 8.Communication 9.NOS Menu
2.	Use the [ <b>▼</b> ] key to scroll to menu option <b>10. Store &amp; Forward</b> and then <b>press [ENTER]</b> .	<b>MERCH. OPTIONS</b> 2.No-Paper Mode 3.Buzzer Set 4.Operation Mode 5.Battery Saver 6.Prf Disclaimer 7.Set Menu Type 8.Set Halo 9.Print Setup 10.Store&Forward
3.	<b>Input the Password</b> and <b>press [ENTER]</b>	<b>ENTER PASSWORD:</b>
4.	<b>Press [6]</b> to Resend Failed Transactions.	<b>STORE&amp;FORWARD</b> 1.S&F On/Off 2.Mode Select 3.Display Trans 4.Reports 5.Upload Transct 6.Resend Failed 7.Delete Failed
5.	<b>Stop.</b>	

## Delete Failed Transactions

### FUNCTION DESCRIPTION

This function allows you to Delete any failed transactions.

STEP	ACTION	DISPLAY
1.	From the Main Menu <b>Press [3]</b> to access Merchant Options	<b>MENU SCREEN:</b> 1.Reports 2.Merch. Params 3.Merch. Options 4.Hosts Params 5.System Options 6.Radio Params 7.Download 8.Communication 9.NOS Menu
2.	Use the [ <b>▼</b> ] key to scroll to menu option <b>10. Store &amp; Forward</b> and then <b>press [ENTER]</b> .	<b>MERCH. OPTIONS</b> 2.No-Paper Mode 3.Buzzer Set 4.Operation Mode 5.Battery Saver 6.Pri Disclaimer 7.Set Menu Type 8.Set Halo 9.Print Setup 10.Store&Forward
3.	<b>Input the Password and press [ENTER]</b>	<b>ENTER PASSWORD:</b>
4.	<b>Press [7]</b> to Delete Failed Transactions.	<b>STORE&amp;FORWARD</b> 1.S&F On/Off 2.Mode Select 3.Display Trans 4.Reports 5.Upload Transct 6.Resend Failed 7.Delete Failed
5.	<b>Press [ENTER]</b> to delete failed transactions or <b>press [MENU]</b> to cancel function.	<b>Delete Failed</b> <b>ENTR=YES, MENU=NO</b>
6.	<b>Stop.</b>	

# Check Reader

## FUNCTION DESCRIPTION

This function allows you to setup the check reader or check imager. For the Nurit 8000 SECURE, the terminal must be placed in the Docking Station and the check reader/imager connected to the station.

**Note:** Check Imaging is supported by the POS\_PLUS application only.

STEP	ACTION	DISPLAY
1.	From the Main Menu <b>Press [3]</b> to access Merchant Options	<b>MENU SCREEN:</b> 1.Reports 2.Merch. Params 3.Merch. Options 4.Hosts Params 5.System Options 6.Radio Params 7.Download 8.Communication 9.NOS Menu
2.	Use the [ <b>▼</b> ] key to scroll to menu option <b>11. Check Reader</b> and then <b>press [ENTER]</b> .	<b>MERCH. OPTIONS</b> 3.Buzzer Set 4.Operation Mode 5.Battery Saver 6.Prt Disclaimer 7.Set Menu Type 8.Set Halo 9.Print Setup 10.Store&Forward 11.Check Reader
3.	<b>Input the Password and press [ENTER]</b>	<b>ENTER PASSWORD:</b>
4.	If a Check Reader is attached, <b>follow steps #4 &amp; 5.</b>  Be sure the check reader is connected to the docking station then <b>press [ENTER]</b> .  If a Check Imager is attached, <b>skip to step #6.</b>	<b>ChkRdr Options</b> 1.ChkRdr Type
5.	The terminal will detect and initialize the type of Check Reader you have connected.	<b>Detecting H/Ware please wait.....</b>



## Check Reader, Continued

STEP	ACTION	DISPLAY
6.	Be sure the check imager is connected to the docking station then <b>press [ENTER]</b> .	<b>ChkRdr Options</b> 1.ChkRdr Type 2.Send Images 3.Clear Images 4.Setup Menu 5.Frinking
7.	The terminal will detect the hardware, verify that imager is connected and possibly <b>instruct</b> that the <b>RDM Imager</b> be <b>turned off then on</b> .	<b>RDM Needs to be Turned OFF &amp; ON</b>
8.	The Check Imager will cycle itself and switch to it's ready state.	
9.	<b>Stop.</b>	



## Check Imager – Send Images (Bridge)

**FUNCTION** This function allows you upload the check images.  
**DESCRIPTION** Note: Check Imaging is supported by the POS\_PLUS application only.

STEP	ACTION	DISPLAY
1.	From the Main Menu <b>Press [3]</b> to access Merchant Options	<b>MENU SCREEN:</b> 1.Reports 2.Merch. Params 3.Merch. Options 4.Hosts Params 5.System Options 6.Radio Params 7.Download 8.Communication 9.NOS Menu
2.	Use the [ <b>▼</b> ] key to scroll to menu option <b>11. Check Reader</b> and then <b>press [ENTER]</b> .	<b>MERCH. OPTIONS</b> 3.Buzzer Set 4.Operation Mode 5.Battery Saver 6.Prj Disclaimer 7.Set Menu Type 8.Set Halo 9.Print Setup 10.Store&Forward 11.Check Reader

Continued on next page.

## Check Imager – Send Images (Bridge), Continued

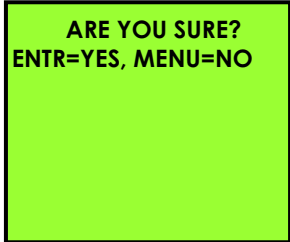
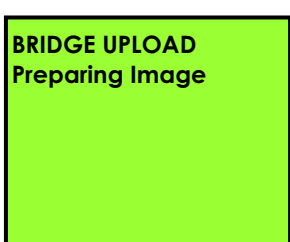
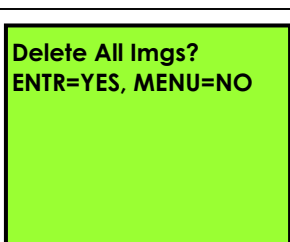
STEP	ACTION	DISPLAY
3.	Input the <b>Password</b> and press <b>[ENTER]</b>	
4.	Press <b>[2]</b> .	
5.	Press <b>[ENTER]</b> .	
6.	Terminal will begin processing and sending the check images.	
7.	After a successful upload, delete existing images. Press <b>[ENTER]</b> .	
8.	<b>Stop.</b>	

## Check Imager – Send Images (FTP)

**FUNCTION** This function allows you upload the check images.  
**DESCRIPTION** Note: Check Imaging is supported by the POS\_PLUS application only.

STEP	ACTION	DISPLAY
1.	From the Main Menu <b>Press [3]</b> to access Merchant Options	<b>MENU SCREEN:</b> 1.Reports 2.Merch. Params 3.Merch. Options 4.Hosts Params 5.System Options 6.Radio Params 7.Download 8.Communication 9.NOS Menu
2.	Use the [▼] key to scroll to menu option <b>11. Check Reader</b> and then <b>press [ENTER]</b> .	<b>MERCH. OPTIONS</b> 3.Buzzer Set 4.Operation Mode 5.Battery Saver 6.Prnt Disclaimer 7.Set Menu Type 8.Set Halo 9.Print Setup 10.Store&Forward 11.Check Reader
3.	<b>Input the Password</b> and <b>press [ENTER]</b>	<b>ENTER PASSWORD:</b>
4.	<b>Press [2]</b> .	<b>ChkRdr Options</b> 1.ChkRdr Type 2.Send Images 3.Clear Images 4.Setup Menu 5.Frinking
5.	<b>Press [ENTER]</b> .	<b>ARE YOU SURE?</b> <b>ENTR=YES, MENU=NO</b>

*Continued on next page.*

## Check Imager – Send Images (FTP), Continued

STEP	ACTION	DISPLAY
6.	Terminal will begin transmitting the check images and display message when complete.	
7.	<b>Stop.</b>	

## Check Imager – Clear Images

This function allows you delete the check images.



**FUNCTION DESCRIPTION**

**Note:** Check Imaging is supported by the POS\_PLUS application only.

STEP	ACTION	DISPLAY
1.	From the Main Menu <b>Press [3]</b> to access Merchant Options	
2.	Use the [ <b>▼</b> ] key to scroll to menu option <b>11. Check Reader</b> and then press [ <b>ENTER</b> ].	
3.	<b>Input the Password</b> and press [ <b>ENTER</b> ]	

*Continued on next page.*

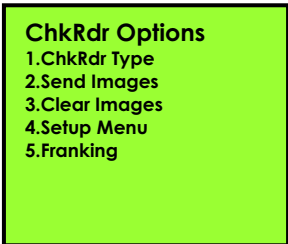
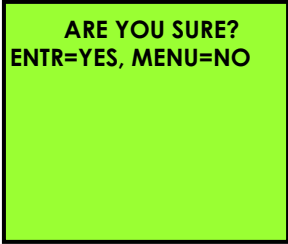
## Check Imager – Clear Images

STEP	ACTION	DISPLAY
4.	Press [3].	 <p><b>ChkRdr Options</b>            1.ChkRdr Type            2.Send Images            3.Clear Images            4.Setup Menu            5.Frinking</p>
5.	Press [ENTER].	 <p><b>ARE YOU SURE?</b>            ENTR=YES, MENU=NO</p>
6.	Terminal will delete the check images and display message when complete.	 <p><b>Deleting Images</b>            Please Wait . . .</p>
7.	<b>Stop.</b>	

## Check Imager – Setup Menu (Bridge)

### FUNCTION DESCRIPTION

This function accesses the FTP setup menu allowing editing of the parameters and setup configuration.

**Note:** Check Imaging is supported by the POS\_PLUS application only.

STEP	ACTION	DISPLAY
1.	From the Main Menu <b>Press [3]</b> to access Merchant Options	<b>MENU SCREEN:</b> 1.Reports 2.Merch. Params 3.Merch. Options 4.Hosts Params 5.System Options 6.Radio Params 7.Download 8.Communication 9.NOS Menu
2.	Use the [ <b>▼</b> ] key to scroll to menu option <b>11. Check Reader</b> and then <b>press [ENTER]</b> .	<b>MERCH. OPTIONS</b> 3.Buzzer Set 4.Operation Mode 5.Battery Saver 6.Prt Disclaimer 7.Set Menu Type 8.Set Halo 9.Print Setup 10.Store&Forward 11.Check Reader
3.	<b>Input the Password</b> and <b>press [ENTER]</b>	<b>ENTER PASSWORD:</b>
4.	<b>Press [4]</b> .	<b>ChkRdr Options</b> 1.ChkRdr Type 2.Send Images 3.Clear Images 4.Setup Menu 5.Frinking
5.	<b>Press [1]</b> to switch communication format.  <b>Note:</b> After switching from Bridge to FTP, the FTP Setup parameters are displayed and modifiable.	<b>Setup Menu</b> 1.Upload via →

## Check Imager – Setup Menu (Bridge), Continued

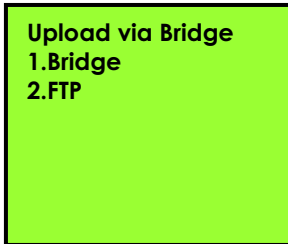
STEP	ACTION	DISPLAY
6.	<p>Press [1] to switch communications to Bridge.</p> <p>Press [2] to switch communications to FTP.</p> <p>Press [MENU/ESC] to exit without change.</p>	
7.	Stop.	

## Check Imager – Setup Menu (FTP)

### FUNCTION DESCRIPTION

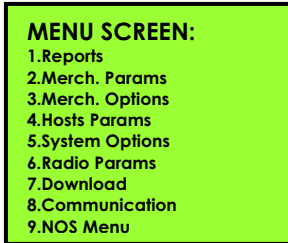
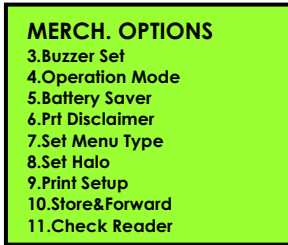

This function accesses the FTP setup menu allowing editing of the parameters and setup configuration.

**Note:** Check Imaging is supported by the POS\_PLUS application only.

STEP	ACTION	DISPLAY
1.	From the Main Menu Press [3] to access Merchant Options	
2.	Use the [▼] key to scroll to menu option 11. Check Reader and then press [ENTER].	

Continued on next page.

## Check Imager – Setup Menu (FTP), Continued

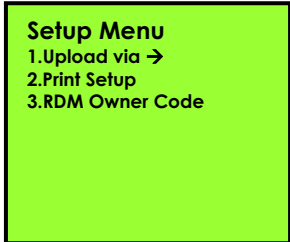
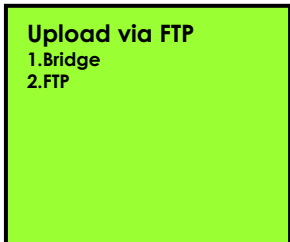
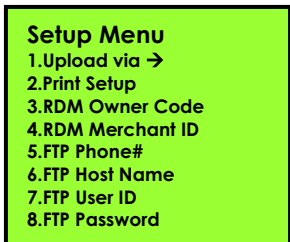
STEP	ACTION	DISPLAY
3.	Input the <b>Password</b> and press <b>[ENTER]</b>	 <p>ENTER PASSWORD:</p>
4.	Press <b>[4]</b> .	 <p>ChkRdr Options  1.ChkRdr Type  2.Send Images  3.Clear Images  4.Setup Menu  5.Frinking</p>
5.	Press <b>[1]</b> to switch communication format.  <b>Note:</b> When switching from FTP to Bridge, the remaining Setup parameters are not applicable and will not be displayed.	 <p>Setup Menu  1.Upload via →  2.Print Setup  3.RDM Owner Code</p>
6.	Press <b>[1]</b> to switch to Bridge.  Press <b>[2]</b> to switch to FTP.  Press <b>[MENU]</b> to exit without change.	 <p>Upload via FTP  1.Bridge  2.FTP</p>
7.	Press <b>[2]</b> to print the FTP Setup information.	 <p>Setup Menu  1.Upload via →  2.Print Setup  3.RDM Owner Code  4.RDM Merchant ID  5.FTP Phone#  6.FTP Host Name  7.FTP User ID  8.FTP Password</p>

Continued on next page.



## Check Imager – Setup Menu (FTP), Continued

STEP	ACTION	DISPLAY
8.	Press [3] for the RDM Owner Code.	<div style="border: 1px solid black; background-color: #90EE90; padding: 5px;"> <p><b>Setup Menu</b></p> <ul style="list-style-type: none"> <li>1.Upload via →</li> <li>2.Print Setup</li> <li>3.RDM Owner Code</li> <li>4.RDM Merchant ID</li> <li>5.FTP Phone#</li> <li>6.FTP Host Name</li> <li>7.FTP User ID</li> <li>8.FTP Password</li> </ul> </div>
9.	Enter Owner Code then press [ENTER].	<div style="border: 1px solid black; background-color: #90EE90; padding: 5px;"> <p><b>Setup Menu</b></p> <p>RDM Owner Code</p> </div>
10.	Press [4] for RDM Merchant ID.	<div style="border: 1px solid black; background-color: #90EE90; padding: 5px;"> <p><b>Setup Menu</b></p> <ul style="list-style-type: none"> <li>1.Upload via →</li> <li>2.Print Setup</li> <li>3.RDM Owner Code</li> <li>4.RDM Merchant ID</li> <li>5.FTP Phone#</li> <li>6.FTP Host Name</li> <li>7.FTP User ID</li> <li>8.FTP Password</li> </ul> </div>
11.	Enter Merchant ID then press [ENTER].	<div style="border: 1px solid black; background-color: #90EE90; padding: 5px;"> <p><b>Setup Menu</b></p> <p>RDM MerchantID</p> </div>
12.	Press [5] for FTP Phone Number.	<div style="border: 1px solid black; background-color: #90EE90; padding: 5px;"> <p><b>Setup Menu</b></p> <ul style="list-style-type: none"> <li>1.Upload via →</li> <li>2.Print Setup</li> <li>3.RDM Owner Code</li> <li>4.RDM Merchant ID</li> <li>5.FTP Phone#</li> <li>6.FTP Host Name</li> <li>7.FTP User ID</li> <li>8.FTP Password</li> </ul> </div>
13.	Enter the FTP Phone Number then press [ENTER].	<div style="border: 1px solid black; background-color: #90EE90; padding: 5px;"> <p><b>Setup Menu</b></p> <p>FTP Phone #</p> </div>

Continued on next page.

## Check Imager – Setup Menu (FTP), Continued

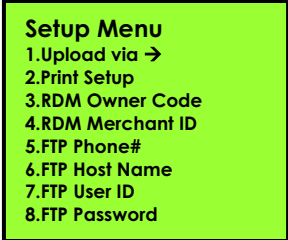
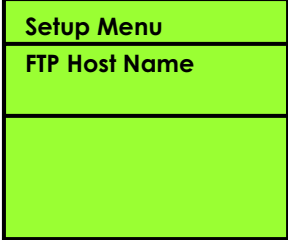
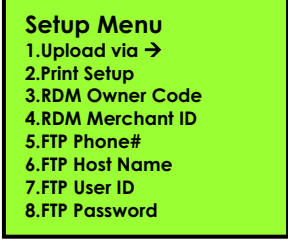
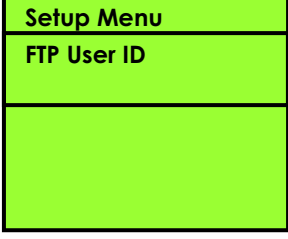
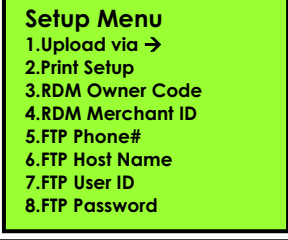
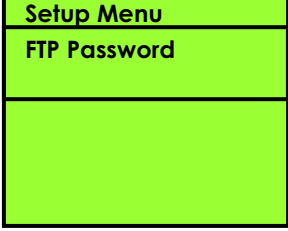
STEP	ACTION	DISPLAY
14.	Press [6] for FTP Host Name.	 <p>Setup Menu            1.Upload via →            2.Print Setup            3.RDM Owner Code            4.RDM Merchant ID            5.FTP Phone#            6.FTP Host Name            7.FTP User ID            8.FTP Password</p>
15.	Enter the FTP Host Name then press [ENTER].	 <p>Setup Menu            FTP Host Name</p>
16.	Press [7] for the FTP User ID.	 <p>Setup Menu            1.Upload via →            2.Print Setup            3.RDM Owner Code            4.RDM Merchant ID            5.FTP Phone#            6.FTP Host Name            7.FTP User ID            8.FTP Password</p>
17.	Enter the FTP User ID then press [ENTER].	 <p>Setup Menu            FTP User ID</p>
18.	Press [8] for FTP Password.	 <p>Setup Menu            1.Upload via →            2.Print Setup            3.RDM Owner Code            4.RDM Merchant ID            5.FTP Phone#            6.FTP Host Name            7.FTP User ID            8.FTP Password</p>
19.	Enter the FTP Password then press [ENTER].	 <p>Setup Menu            FTP Password</p>

Continued on next page.

## Check Imager – Setup Menu (FTP), Continued

STEP	ACTION	DISPLAY
20.	Press [9] for FTP Send Mode.	<p>Setup Menu</p> <ul style="list-style-type: none"> <li>2.Print Setup</li> <li>3.RDM Owner Code</li> <li>4.RDM Merchant ID</li> <li>5.FTP Phone#</li> <li>6.FTP Host Name</li> <li>7.FTP User ID</li> <li>8.FTP Password</li> <li>9.FTP Send Mdde</li> </ul>
21.	Press [1] to send the images in a batch or press [2] to send the images individually.	<p>FTP Send Mode</p> <p>1-Batch 2-Indiv.</p>
22.	Press [10] for PPP User ID.	<p>Setup Menu</p> <ul style="list-style-type: none"> <li>3.RDM Owner Code</li> <li>4.RDM Merchant ID</li> <li>5.FTP Phone#</li> <li>6.FTP Host Name</li> <li>7.FTP User ID</li> <li>8.FTP Password</li> <li>9.FTP Send Mode</li> <li>10.PPP User ID</li> </ul>
23.	Enter the PPP User ID then press [ENTER].	<p>Setup Menu</p> <p>PPP User ID</p>
24.	Press [11] for PPP Password.	<p>Setup Menu</p> <ul style="list-style-type: none"> <li>4.RDM Merchant ID</li> <li>5.FTP Phone#</li> <li>6.FTP Host Name</li> <li>7.FTP User ID</li> <li>8.FTP Password</li> <li>9.FTP Send Mode</li> <li>10.PPP User ID</li> <li>11.PPP Password</li> </ul>
25.	Enter the PPP Password then press [ENTER].	<p>Setup Menu</p> <p>PPP Password</p>

Continued on next page.

## Check Imager – Setup Menu (FTP), Continued

STEP	ACTION	DISPLAY
26.	Press [12] for RDM Autodial.	<b>Setup Menu</b> 5.FTP Phone# 6.FTP Host Name 7.FTP User ID 8.FTP Password 9.FTP Send Mode 10.PPP User ID 11.PPP Password 12.RDM Autodial
27.	Press [1] to turn Autodial on and set the parameters or press [2] to turn Autodial off.	<b>Autodial is ON</b> 1-ON , 2-OFF
28.	Enter the time the Autodial process is to start then press [ENTER].  <b>Note:</b> Remember the terminal has a 24-hour clock.	<b>START AT:</b> 01:00
29.	Enter the time the Autodial process is to stop then press [ENTER].	<b>STOP AT:</b> 02:00
30.	Enter the interval time then press [ENTER].	<b>START AT:</b> <b>AD INTERVAL (min)</b> 10
31.	Stop.	

## Check Imager – Franking

### FUNCTION DESCRIPTION

Franking is marking the check with an **ELECTRONICALLY PRESENTED** message. Use the following step action table to enable/disable Franking.

**Note:** Not all Check Imagers support Franking.

STEP	ACTION	DISPLAY
1.	From the Main MENU SCREEN <b>press [3]</b> to access Merchant Options	<b>MENU SCREEN</b> 1.Reports 2.Merch. Params 3.Merch. Options 4.Hosts Params 5.System Options 6.Radio Params 7.Download 8.Communication 9.NOS Menu
2.	Use the [▼] arrow (Forced Key) to scroll to <b>11. Check Reader</b> then <b>press [ENTER]</b>	<b>MERCH. OPTIONS</b> 3.Buzzer Set 4.Operation Mode 5.Battery Saver 6.Prt Disclaimer 7.Set Menu Type 8.Set Halo 9.Print Setup 10.Store&Forward 11.Check Reader
3.	<b>Input the Password</b> and <b>press [ENTER]</b>	<b>ENTER PASSWORD:</b>
4.	<b>Press [5].</b>	<b>ChkRdr Options</b> 1.ChkRdr Type 2.Send Images 3.Clear Images 4.Setup Menu 5.Franking
5.	<b>Press [1]</b> to disable Franking or <b>[2]</b> to enable Franking.	<b>Franking</b> 1.OFF 2.ON
6.	<b>Stop.</b>	

## Signature Option

### FUNCTION DESCRIPTION

This option is used to enable capturing the signature from the touch screen and printing it on the receipt.

**Note:** Signature Option is supported by the POS\_PLUS application only.

STEP	ACTION	DISPLAY
1.	From the Main MENU SCREEN <b>press [3]</b> to access Merchant Options	<b>MENU SCREEN:</b> 1.Reports 2.Merch. Params 3.Merch. Options 4.Hosts Params 5.System Options 6.Radio Params 7.Download 8.Communication 9.NOS Menu
2.	Use the [▼] arrow (Forced Key) to scroll to <b>12. Sign. Option</b> then <b>press [ENTER]</b>	<b>MERCH. OPTIONS:</b> 4.Operation Mode 5.Battery Saver 6.Prt Disclaimer 7.Set Menu Type 8.Set Halo 9.Print Setup 10.Store&Forward 11.Check Reader 12.Sian. Option
3.	<b>Input the Password</b> and <b>press [ENTER]</b>	<b>ENTER PASSWORD:</b>
4.	<b>Press [2]</b> to enable signature capture then <b>press [ENTER]</b>	<b>Sign. Capt. OFF</b> 1.OFF 2.ON
5.	<b>Stop.</b>	

# Bridge Communication

## FUNCTION DESCRIPTION

This menu functions allows you to set communication parameters for uploading captured images to the web via Bridge Communication.

**Note:** Bridge Communication is supported by the POS\_PLUS application only.

STEP	ACTION	DISPLAY
1.	From the Main MENU SCREEN <b>press [3]</b> to access Merchant Options	<b>MENU SCREEN:</b> 1.Reports 2.Merch. Params 3.Merch. Options 4.Hosts Params 5.System Options 6.Radio Params 7.Download 8.Communication 9.NOS Menu
2.	Use the [▼] arrow (Forced Key) to scroll to <b>13. Bridge Comm</b> then Press <b>[ENTER]</b>	<b>MERCH. OPTIONS:</b> 5.Battery Saver 6.Prnt Disclaimer 7.Set Menu Type 8.Set Halo 9.Print Setup 10.Store&Forward 11.Check Reader 12.Sign. Option 13.Bridae Comm
3.	Select the appropriate communication parameter (specific to the Bridge) by pressing <b>[ENTER]</b> , then edit as <b>desired.</b>	<b>PARAMS (Modem)</b> 1.Phone> 2. Via>Modem 3.Baud>2400 4.Fast Con>No
4.	<b>Stop.</b>	

# Language Setup

**FUNCTION** This menu functions allows you to set the Display and Printer Language.  
**DESCRIPTION** **Note:** Language Setup is supported by the POS\_PLUS application only.

STEP	ACTION	DISPLAY
1.	From the Main MENU SCREEN <b>press [3]</b> to access Merchant Options	<b>MENU SCREEN:</b> 1.Reports 2.Merch. Params 3.Merch. Options 4.Hosts Params 5.System Options 6.Radio Params 7.Download 8.Communication 9.NOS Menu
2.	Use the [▼] arrow (Forced Key) to scroll to <b>14. Language Setup</b> then Press <b>[ENTER]</b>	<b>MERCH. OPTIONS:</b> 6.Pri Disclaimer 7.Set Menu Type 8.Set Halo 9.Print Setup 10.Store&Forward 11.Check Reader 12.Sign. Option 13.Bridge Comm 14.Lanauage Set
3.	<b>Press [1]</b> to change the Display Language or <b>[2]</b> to change the Printer Language.	<b>LANGUAGE SETUP</b> 1.Display 2.Printer
4.	<b>Press</b> the number that corresponds with the desired language.	<b>CHOOSE LANGUAGE</b> 2.ENGLISH 9.SPANISH
5.	<b>Stop.</b>	



## 4. Host Parameters

This menu allows you to change host parameters, such as merchant numbers, terminal IDs, authorization/batch phone numbers and the radio address. Each host has different individual parameters, which should be changed only if advised by the processing bank or NURIT technical support. If the terminal capture type is either Host Manual or Terminal, the AutoDial feature can be activated and the time/duration can be modified. There are six sub-menus in Host Parameters.

### MENU DESCRIPTION

- Host Parameters     Host Phones     Print EDC Setup  
 Protocol Version     AutoDial Setup     Host Radio Address

## Host Parameters

### FUNCTION DESCRIPTION

This allows you to edit your Host Processor parameters.

STEP	ACTION	DISPLAY
1.	From the Main Menu <b>Press [4]</b> to access Host Parameters	<b>MENU SCREEN:</b> 1.Reports 2.Merch. Params 3.Merch. Options 4.Hosts Params 5.System Options 6.Radio Params 7.Download 8.Communication 9.NOS Menu
2.	<b>Press [1]</b> for Host Parameters	<b>HOST PARAMS:</b> 1.Hosts Params 2.Hosts Phone 3.Prrt EDC Setup 4.Protocol Ver 5.AutoDial Setup 6.Host Radio Addr
3.	<b>Input the Password and press [ENTER]</b>	<b>ENTER PASSWORD:</b>
4.	Use the [ <b>▲</b> ] and [ <b>▼</b> ] scroll through the different hosts. Select the desired host and then <b>press [ENTER]</b> .  <i>Or</i> <b>Press</b> the number corresponding with your selection.  <b>NOTE:</b> The actual Host name will appear on the display for each EDC Type.	<b>EDC PARAMETERS</b> 1.Host Name CR 2.Host Name DB 3.Host Name CK

Continued on next page

## Host Parameters, Continued

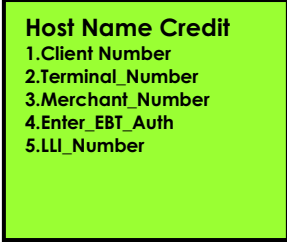
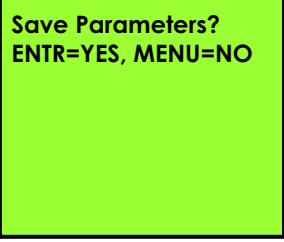
STEP	ACTION	DISPLAY
5.	Use the [▲] and [▼] to scroll through the different parameters. Find the parameter that you wish to edit and then <b>press [ENTER]</b> . <i>Or</i> <b>Press</b> the number corresponding with your selection. <b>Note:</b> Parameter names differ by host.	 <p>Host Name Credit            1.Client Number            2.Terminal_Number            3.Merchant_Number            4.Enter_EBT_Auth            5.LLI_Number</p>
6.	Enter the new parameter information then <b>press [ENTER]</b> .	
7.	Upon completion of all changes <b>press [MENU]</b>	
8.	<b>Press [ENTER]</b> to save the changes <i>Or</i> <b>Press [MENU]</b> to cancel the changes	 <p>Save Parameters?            ENTR=YES, MENU=NO</p>
9.	<b>Stop.</b>	

# Host Phones

**FUNCTION DESCRIPTION** This option allows the changing of authorization phone numbers and batch phone numbers for the host processor.

STEP	ACTION	DISPLAY
1.	From the Main Menu <b>Press [4]</b> to access Host Parameters	<b>MENU SCREEN:</b> 1.Reports 2.Merch. Params 3.Merch. Options 4.Hosts Params 5.System Options 6.Radio Params 7.Download 8.Communication 9.NOS Menu
2.	<b>Press [2]</b> for Hosts Phones	<b>HOST PARAMS:</b> 1.Hosts Params 2.Hosts Phone 3.Prnt EDC Setup 4.Protocol Ver 5.AutoDial Setup 6.Host Radio Addr
3.	<b>Input the Password then press [ENTER]</b>	<b>ENTER PASSWORD:</b>
4.	Use the [ <b>▲</b> ] and [ <b>▼</b> ] scroll through the different hosts. Select the host that you wish to edit phone numbers for and then <b>press [ENTER]</b> . <i>Or</i> <b>Press</b> the number corresponding with your selection. <b>Note:</b> The actual Host name will appear on the display for each EDC Type.	<b>PHONE MENU:</b> 1.Host Name CR 2.Host Name DB 3.Host Name CK
5.	To Edit Authorization Phone Numbers <b>press [1]</b> <i>Or</i> To Edit Batch Phone Numbers <b>press [2]</b>	<b>PHONE TYPE</b> 1.Auth. Phones 2.Batch Phones

Continued on next page

## Host Phones, Continued

STEP	ACTION	DISPLAY
6.	Select which phone number you wish to edit.  To set communication for radio before phone line, <b>press [4]</b> and skip to Step #10.	<pre> EDIT PHONE 1.Phone # 1 2.Phone # 2 3.Phone # 3 4.Line B4 Radio           </pre>
7.	The blinking cursor will be positioned on the first character of the existing phone number. Enter the new phone number.  Delete any of the old number with the <b>[BS]</b> key.  Upon completion <b>press [ENTER]</b> .	<pre> EDIT PHONE 1.Phone # 1 2.Phone # 2 3.Phone # 3  Phone # 1 186654055XX           </pre>
8.	The existing baud rate will be highlighted, <b>press [MENU]</b> to keep existing rate or <b>enter</b> the number that corresponds to the desired baud rate then <b>press [ENTER]</b> .	<pre> Baud Rate: 1.300 2.1200 3.2400 4.4800 5.7200 6.9600 7.12200 8.14400           </pre>
9.	Select the next phone number to be changed and repeat Steps 7 & 8.	<pre> EDIT PHONE 1.Phone # 1 2.Phone # 2 3.Phone # 3           </pre>
10.	If Line B4 Radio was selected:  <b>Press [1]</b> to verify that the terminal will not try to communicate via the phone line before the radio.	<pre> Line Before: OFF 1.OFF 2.ON           </pre>
11.	<b>Press [MENU]</b> twice and you will be prompted to save your changes. <b>Press [ENTER]</b> to save the changes. <i>Or</i> <b>Press [MENU]</b> to cancel the changes.	<pre> Save Parameters? ENTR=YES, MENU=NO           </pre>
12.	<b>Stop.</b>	

# Print EDC Setup

---

**FUNCTION DESCRIPTION** This report prints host information such as merchant numbers, phone numbers, baud rates, capture type and radio information.

STEP	ACTION	DISPLAY
1.	From the Main Menu <b>Press [4]</b> to access Host Parameters.	<div style="border: 1px solid black; background-color: #90EE90; padding: 5px;"> <p><b>MENU SCREEN:</b></p> <ul style="list-style-type: none"> <li>1.Reports</li> <li>2.Merch. Params</li> <li>3.Merch. Options</li> <li>4.Hosts Params</li> <li>5.System Options</li> <li>6.Radio Params</li> <li>7.Download</li> <li>8.Communication</li> <li>9.NOS Menu</li> </ul> </div>
2.	<b>Press [3]</b> to Print EDC Setup.	<div style="border: 1px solid black; background-color: #90EE90; padding: 5px;"> <p><b>HOST PARAMS:</b></p> <ul style="list-style-type: none"> <li>1.Hosts Params</li> <li>2.Hosts Phone</li> <li>3.Print EDC Setup</li> <li>4.Protocol Ver</li> <li>5.AutoDial Setup</li> <li>6.Host Radio Addr</li> </ul> </div>
3.	<b>Input the Password</b> then press <b>[ENTER]</b> .	<div style="border: 1px solid black; background-color: #90EE90; padding: 5px;"> <p><b>ENTER PASSWORD:</b></p> </div>
4.	<b>Stop.</b>	

---

# Protocol Version

**FUNCTION DESCRIPTION** This displays the protocol/host version. This is mainly viewed by programmers or Customer Support Representatives.

STEP	ACTION	DISPLAY
1.	From the Main Menu <b>Press [4]</b> to access Host Parameters	<b>MENU SCREEN:</b> 1.Reports 2.Merch. Params 3.Merch. Options 4.Hosts Params 5.System Options 6.Radio Params 7.Download 8.Communication 9.NOS Menu
2.	<b>Press [4]</b> for Protocol Version	<b>HOST PARAMS:</b> 1.Hosts Params 2.Hosts Phone 3.Pmt EDC Setup 4.Protocol Ver 5.AutoDial Setup 6.Host Radio Addr
3.	<b>Select the EDC Type</b> you would like to view the Protocol Version for.	<b>CHOOSE EDC TYPE</b> 2.CREDIT 3.DEBIT 4.EBT
4.	<b>Press Any Key</b> to go back to the previous screen.  <b>Note:</b> The Actual Protocol Version will appear on the display.	<b>HOST Ver. 00.00</b> <b>Press Any Key...</b>
5.	<b>Stop.</b>	

# AutoDial Setup

## FUNCTION DESCRIPTION

If the terminal capture type is Host Manual or Terminal Capture, the AutoDial feature will automatically perform the manual batch function. If the terminal capture type is Autobatch, this function is not applicable.

STEP	ACTION	DISPLAY
1.	From the Main Menu <b>Press [4]</b> to access Host Parameters	<b>MENU SCREEN:</b> 1.Reports 2.Merch. Params 3.Merch. Options 4.Hosts Params 5.System Options 6.Radio Params 7.Download 8.Communication 9.NOS Menu
2.	<b>Press [5]</b> to view Autodial Setup	<b>HOST PARAMS:</b> 1.Hosts Params 2.Hosts Phone 3.Prm EDC Setup 4.Protocol Ver 5.AutoDial Setup 6.Host Radio Addr
3.	<b>Input the Password then press [ENTER].</b>	<b>ENTER PASSWORD:</b>
4.	<b>Press [1]</b> for ALL or <b>select</b> the desired host.	<b>CHOOSE HOST</b> 1.ALL 2.Credit Host 3.Debit Host
5.	<b>Press [1]</b> to turn AutoDial OFF or <b>press [2]</b> to turn AutoDial ON.	<b>AUTODIAL SETUP</b> 1.OFF 2.ON

*Continued on next page*

## AutoDial Setup, Continued

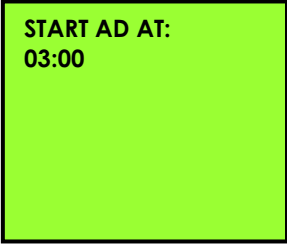
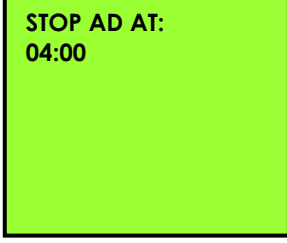
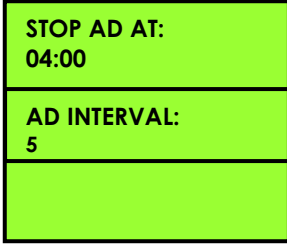
STEP	ACTION	DISPLAY
6.	<p>If AutoDial was turned on the system will prompt for the AutoDial start time.</p> <p>Enter the start time then <b>press [ENTER]</b>. Remember that the terminal has a 24-hour (military) clock.</p>	
7.	<p>Enter the stop time then <b>press [ENTER]</b>. Stop time is usually one hour after start time.</p>	
8.	<p>Enter the AutoDial time interval then <b>press [ENTER]</b>. The interval is usually 5 minutes.</p>	
9.	<b>Stop.</b>	



# Host Radio Address

## FUNCTION DESCRIPTION

Displays and allows the editing of Host Radio Addresses on Mobitex and Motient wireless terminals. If the terminal is wireless CDPD or is not wireless, this function will not be available.

STEP	ACTION	DISPLAY
1.	From the Main Menu <b>Press [4]</b> to access Host Parameters	<b>MENU SCREEN:</b> 1.Reports 2.Merch. Params 3.Merch. Options 4.Hosts Params 5.System Options 6.Radio Params 7.Download 8.Communication 9.NOS Menu
2.	<b>Press [6]</b> for Host Radio Address.	<b>HOST PARAMS:</b> 1.Hosts Params 2.Hosts Phone 3.Prnt EDC Setup 4.Protocol Ver 5.AutoDial Setup 6.Host Radio Addr
3.	<b>Input the Password</b> then <b>press [ENTER]</b>	<b>ENTER PASSWORD:</b>
4.	<b>Select the desired host.</b>	<b>Radio Addresses</b> 1.Credit Host 2.Debit Host
5.	<b>Press [1]</b> for Authorization Radio Address <u>Or</u> <b>Press [2]</b> for Batch Radio Address.	<b>Radio Addresses</b> 1.Auth. Radio: 2.Batch Radio:

Continued on next page.

## Host Radio Address, Continued

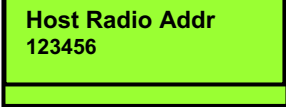
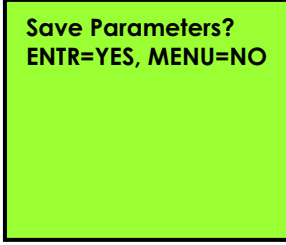
STEP	ACTION	DISPLAY
6.	Enter the new Radio Address then <b>press [ENTER]</b> <i>Or</i> <b>Press [MENU]</b> to exit function without modifying. <b>Note:</b> Radio Addresses should not be modified without technical advisement.	 
7.	<b>Press [ENTER]</b> to save the new parameter <i>Or</i> <b>Press [MENU]</b> to cancel.	
8.	<b>Stop.</b>	



## 5. System Options

This menu consists of twelve different functions that can be changed manually.

MENU DESCRIPTION	<input type="checkbox"/> Set Time/Date	<input type="checkbox"/> Edit PIN Key	<input type="checkbox"/> Sel. Master Key	<input type="checkbox"/> Set Batch No.
	<input type="checkbox"/> Edit Database	<input type="checkbox"/> Working Mode	<input type="checkbox"/> Test Mode	<input type="checkbox"/> Predial Call
	<input type="checkbox"/> PIN Pad Initialize	<input type="checkbox"/> PIN Pad Function	<input type="checkbox"/> PIN Pad Config.	<input type="checkbox"/> Status Bar

### Set Terminal Time and Date

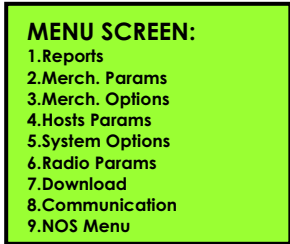
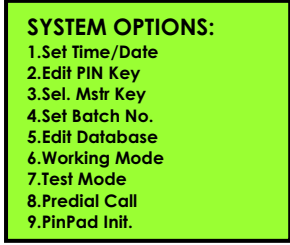
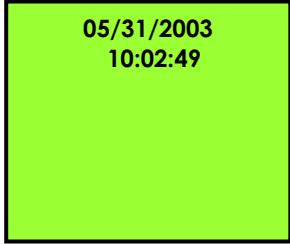
FUNCTION DESCRIPTION	This option allows you to set the time and date in the terminal.
----------------------	--

STEP	ACTION	DISPLAY
1.	From the Main MENU SCREEN <b>press [5]</b> to access System Options.	 <p><b>MENU SCREEN:</b>  1.Reports  2.Merch. Params  3.Merch. Options  4.Hosts Params  5.System Options  6.Radio Params  7.Download  8.Communication  9.NOS Menu</p>
2.	<b>Press [ENTER]</b> to Set the Time and Date.	 <p><b>SYSTEM OPTIONS:</b>  1.Set Time/Date  2.Edit PIN Key  3.Sel. Mstr Key  4.Set Batch No.  5.Edit Database  6.Working Mode  7.Test Mode  8.Predial Call  9.PinPad Init.</p>
3.	Verify the current Time and Date is incorrect then <b>press [ENTER]</b> to edit.	 <p>05/31/2003  10:02:49</p>
4.	<b>Input</b> the correct <b>date</b> using MM/DD/YY format.	 <p><b>SETTING DATE:</b>  MM/DD/YY</p>

*Continued on next page*

## Set Terminal Time and Date, Continued

---

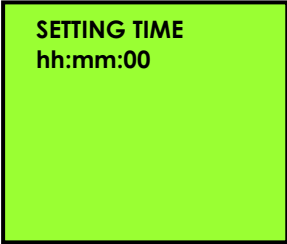
STEP	ACTION	DISPLAY
5.	<b>Input</b> the correct <b>time</b> using Military (24-hour) Format	
6.	Verify the time and date is now correct and <b>press [MENU]</b>	
7.	<b>Stop.</b>	

---

# Edit PIN Key

## FUNCTION DESCRIPTION

This option allows the changing or viewing of the working key for the PIN pad (access to this menu is not available without a PIN pad). The only time a change should be made in this field is if instructed by customer service.

STEP	ACTION	DISPLAY
1.	From the Main MENU SCREEN <b>press [5]</b> to access System Options.	<b>MENU SCREEN:</b> 1.Reports 2.Merch. Params 3.Merch. Options 4.Hosts Params 5.System Options 6.Radio Params 7.Download 8.Communication 9.NOS Menu
2.	<b>Press [ENTER]</b> to Set the Time and Date.	<b>SYSTEM OPTIONS:</b> 1.Set Time/Date 2.Edit PIN Key 3.Sel. Mstr Key 4.Set Batch No. 5.Edit Database 6.Working Mode 7.Test Mode 8.Predial Call 9.PinPad Init.
3.	<b>Input the Password and Press [ENTER]</b>	<b>ENTER PASSWORD:</b>
4.	Place the curser over the number you wish to edit using the [ <b>▲</b> ] and [ <b>▼</b> ] keys. <u>Or</u> <b>Press [CLEAR]</b> to remove the entire Working Key, then input the new one.	<b>ENTER PASSWORD:</b> **** <b>EDIT WORKING KEY</b> 0000000000000000
	Upon completion <b>Press [ENTER]</b>	
5.	<b>Stop.</b>	

# Select Master Key Location

**FUNCTION DESCRIPTION**

This changes the Master key location (access to this menu is not available without a PIN pad). Again, this is a field that should only be changed if instructed by customer service.

STEP	ACTION	DISPLAY
1.	From the Main MENU SCREEN <b>press [5]</b> to access System Options.	<div style="border: 1px solid black; background-color: #90EE90; padding: 5px;"> <p><b>MENU SCREEN:</b>                      1.Reports                      2.Merch. Params                      3.Merch. Options                      4.Hosts Params                      5.System Options                      6.Radio Params                      7.Download                      8.Communication                      9.NOS Menu</p> </div>
2.	<b>Press [3]</b> to Select Master Key	<div style="border: 1px solid black; background-color: #90EE90; padding: 5px;"> <p><b>SYSTEM OPTIONS:</b>                      1.Set Time/Date                      2.Edit PIN Key                      3.Sel. Mstr Key                      4.Set Batch No.                      5.Edit Database                      6.Working Mode                      7.Test Mode                      8.Predial Call                      9.PinPad Init.</p> </div>
3.	<b>Input the Password and Press [ENTER]</b>	<div style="border: 1px solid black; background-color: #90EE90; padding: 5px;"> <p><b>ENTER PASSWORD:</b></p> </div>
4.	<b>Input the correct Master Key Location and Press [ENTER]</b>	<div style="border: 1px solid black; background-color: #90EE90; padding: 5px;"> <p><b>ENTER PASSWORD:</b></p> <hr/> <p><b>MASTER LOCATION</b> 0</p> </div>
5.	<b>Stop.</b>	

## Set Batch Number

### FUNCTION DESCRIPTION

This menu option allows the batch number to be changed, if needed. This is also a field that should only be changed when instructed by customer service. To change the batch number:

STEP	ACTION	DISPLAY
1.	From the Main MENU SCREEN <b>press [5]</b> to access System Options.	<b>MENU SCREEN:</b> 1.Reports 2.Merch. Params 3.Merch. Options 4.Hosts Params 5.System Options 6.Radio Params 7.Download 8.Communication 9.NOS Menu
2.	<b>Press [4]</b> to Set the Batch Number	<b>SYSTEM OPTIONS:</b> 1.Set Time/Date 2.Edit PIN Key 3.Sel. Mstr Key 4.Set Batch No. 5.Edit Database 6.Working Mode 7.Test Mode 8.Predial Call 9.PinPad Init.
3.	<b>Input the Password</b> and <b>Press [ENTER]</b>	<b>ENTER PASSWORD:</b>
4.	Choose Host requiring batch number change.	<b>CHOOSE HOST</b> 2.Credit Host 3.Debit Host

*Continued on next page*

## Set Batch Number, Continued

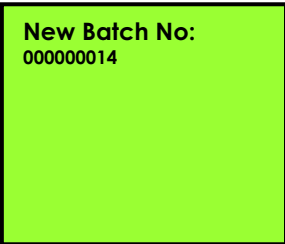
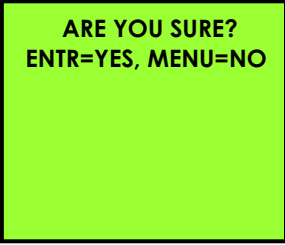
STEP	ACTION	DISPLAY
5.	Input the <b>New Batch #</b> then <b>press [ENTER]</b> .	
6.	Press <b>[ENTER]</b> to complete.  <i>Or</i>  Press <b>[MENU]</b> to cancel.	
7.	<b>Stop.</b>	



## Edit Database

### FUNCTION DESCRIPTION

This sub-menu has three options, Void Transaction, Clear Database and Clear Offline. Void transaction will void a transaction by the transaction number. Clear Database will delete a batch and all its transactions. Clear Offline will clear all the offline transactions in the terminal.

### Edit Database – Void a Transaction

STEP	ACTION	DISPLAY
1.	From the Main MENU SCREEN <b>press [5]</b> to access System Options.	<b>MENU SCREEN:</b> 1.Reports 2.Merch. Params 3.Merch. Options 4.Hosts Params 5.System Options 6.Radio Params 7.Download 8.Communication 9.NOS Menu
2.	<b>Press [5]</b> to Edit the Database.	<b>SYSTEM OPTIONS:</b> 1.Set Time/Date 2.Edit PIN Key 3.Sel. Mstr Key 4.Set Batch No. 5.Edit Database 6.Working Mode 7.Test Mode 8.Predial Call 9.PinPad Init.
3.	<b>Press [1]</b>	<b>EDIT DATABASE</b> 1.Void Transact 2.Clear Database 3.Clear Offline
4.	<b>Select</b> an EDC Type .	<b>CHOOSE EDC TYPE</b> 2.CREDIT 3.CASH

*Continued on next page*

## Edit Database – Void a Transaction, Continued

STEP	ACTION	DISPLAY
5.	Input the <b>Password</b> and Press <b>[ENTER]</b>	<div style="border: 1px solid black; background-color: #90EE90; padding: 5px;"> <p style="text-align: center;">ENTER PASSWORD:</p> </div>
6.	Input the <b>transaction number</b> to be voided then press <b>[ENTER]</b> .	<div style="border: 1px solid black; background-color: #90EE90; padding: 5px;"> <p style="text-align: center;">ENTER PASSWORD: * * * *</p> </div> <div style="border: 1px solid black; background-color: #90EE90; padding: 5px; margin-top: 5px;"> <p style="text-align: center;">Transaction # ? 1</p> </div>
7.	View the transaction on the display to verify it is the correct transaction then Press <b>[ENTER]</b> .	<div style="border: 1px solid black; background-color: #90EE90; padding: 5px;"> <p style="text-align: center;">#0001 SL 52.00</p> <p style="text-align: center;">Mastercard 0803</p> </div>
8.	Press <b>[ENTER]</b> to complete <i>Or</i> Press <b>[MENU]</b> to cancel	<div style="border: 1px solid black; background-color: #90EE90; padding: 5px;"> <p style="text-align: center;">Void Trns #1? ENR=YES, MENU=NO</p> </div>
9.	<b>Stop.</b>	

## Edit Database – Clearing the Database

STEP	ACTION	DISPLAY
1.	From the Main MENU SCREEN <b>press [5]</b> to access System Options.	<b>MENU SCREEN:</b> 1.Reports 2.Merch. Params 3.Merch. Options 4.Hosts Params 5.System Options 6.Radio Params 7.Download 8.Communication 9.NOS Menu
2.	<b>Press [5]</b> for Edit Database	<b>SYSTEM OPTIONS:</b> 1.Set Time/Date 2.Edit PIN Key 3.Sel. Mstr Key 4.Set Batch No. 5.Edit Database 6.Working Mode 7.Test Mode 8.Predial Call 9.PinPad Init.
3.	<b>Press [2]</b> to Clear Database	<b>EDIT DATABASE</b> 1.Void Transact 2.Clear Databas 3.Clear Offline
4.	<b>Input the Password and Press [ENTER]</b>	<b>ENTER PASSWORD:</b>
5.	<b>Press [ENTER]</b> to continue <i>Or</i> <b>Press [MENU]</b> to cancel	<b>ARE YOU SURE?</b> <b>ENTR=YES, MENU=NO</b>
6.	<b>Select the EDC type you wish to clear or press [ENTER]</b> for all EDC types.  A report stating which databases were cleared will print.	<b>CHOOSE EDC TYPE</b> 1.ALL 2.CREDIT 3.DEBIT
7.	<b>Stop.</b>	

## Edit Database – CLEAR OFFLINE

STEP	ACTION	DISPLAY
1.	From the Main MENU SCREEN <b>press [5]</b> to access System Options.	<b>MENU SCREEN:</b> 1.Reports 2.Merch. Params 3.Merch. Options 4.Hosts Params 5.System Options 6.Radio Params 7.Download 8.Communication 9.NOS Menu
2.	<b>Press [5]</b> to Edit Database	<b>SYSTEM OPTIONS:</b> 1.Set Time/Date 2.Edit PIN Key 3.Sel. Mstr Key 4.Set Batch No. 5.Edit Database 6.Working Mode 7.Test Mode 8.Predial Call 9.PinPad Init.
3.	<b>Press [3]</b> to Clear Offline	<b>EDIT DATABASE</b> 1.Void Transact 2.Clear Databas 3.Clear Offline
4.	<b>Input the Password and Press [ENTER]</b>	<b>ENTER PASSWORD:</b>
5.	<b>Press [ENTER]</b> to continue  <i>Or</i>  <b>Press [MENU]</b> to cancel	<b>Delete Offline?</b> <b>ENTR=YES, MENU=NO</b>
6.	<b>Stop.</b>	

## Working Mode

**INFORMATION** This sub-menu has four options:

- Tip Options                       AVS Options  
 Card Present Options         Comment Option

## Working Mode – TIP OPTIONS

**FUNCTION  
DESCRIPTION**

This option allows you to include up to three tips per transaction. This option will also allow you to name the tip type for identification and set a default tip amount for each tip as desired. All tips will be processed during the transaction.

STEP	ACTION	DISPLAY
1.	From the Main MENU SCREEN <b>press [5]</b> to access System Options.	<b>MENU SCREEN:</b> 1.Reports 2.Merch. Params 3.Merch. Options 4.Hosts Params 5.System Options 6.Radio Params 7.Download 8.Communication 9.NOS Menu
2.	<b>Press [6]</b> for Working Mode	<b>SYSTEM OPTIONS:</b> 1.Set Time/Date 2.Edit PIN Key 3.Sel. Mstr Key 4.Set Batch No. 5.Edit Database 6.Working Mode 7.Test Mode 8.Predial Call 9.PinPad Init.
3.	<b>Press [1]</b> for Tip Options.	<b>WORKING MODE:</b> 1.Tip Option 2.AVS Option 3.Card Prsnt Opt 4.Cpmment Opt.
4.	<b>Input the Password</b> and <b>Press [ENTER]</b>	<b>ENTER PASSWORD:</b>

*Continued on next page*

## Working Mode – Tip Options, Continued

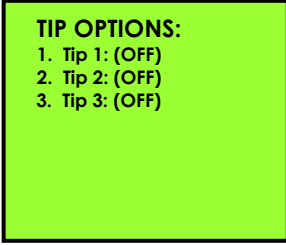
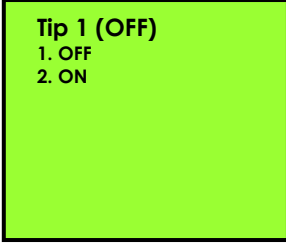
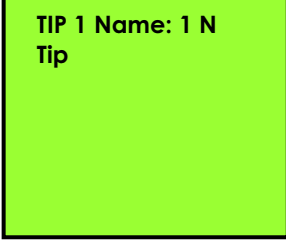
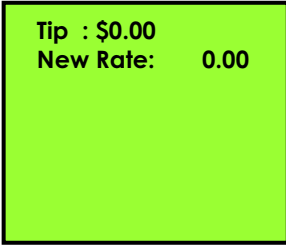
STEP	ACTION	DISPLAY
5.	<p>Use the [▲] and [▼] to scroll through tips options, find the tip that you wish to edit and then <b>press [ENTER]</b>.</p> <p><u>Or</u></p> <p><b>Press</b> the number corresponding with your selection.</p> <p><b>Note:</b> The current status is displayed in parenthesis.</p>	 <p><b>TIP OPTIONS:</b> 1. Tip 1: (OFF) 2. Tip 2: (OFF) 3. Tip 3: (OFF)</p>
6.	<p>Use the [▲] and [▼] to scroll between Off and On then <b>press [ENTER]</b> to select.</p> <p><b>Note:</b> After turning a tip option ON you will then be prompted to edit the Tip name.</p>	 <p><b>Tip 1 (OFF)</b> 1. OFF 2. ON</p>
7.	<p>Using the method described in Editing Header, <b>enter</b> the 13-character tip designation. <b>Press [ENTER]</b> when the name has been entered.</p> <p><b>Press [ENTER]</b> without the modification to keep the existing name.</p>	 <p><b>TIP 1 Name: 1 N Tip</b></p>
8.	<p>If desired, <b>enter</b> the default tip amount then <b>press [ENTER]</b>.</p> <p><u>Or</u></p> <p><b>Press [ENTER]</b> to bypass.</p>	 <p><b>Tip : \$0.00 New Rate: 0.00</b></p>
9.	<b>Stop.</b>	

## Working Mode – AVS OPTIONS

**FUNCTION DESCRIPTION** These options are used for AVS mode. AVS (Address Verification) will prompt the user for a zip code, and street address.



\* There are three options for AVS:

- **OFF** – no prompt for zip code, or street address
- **ON MANUAL ONLY** – will prompt for zip code and street address on a manual entry only
- **ALWAYS** – will prompt for zip code and street address on swiped and manual entries.

STEP	ACTION	DISPLAY
1.	From the Main Menu <b>Press [5]</b> to access System Options	<b>MENU SCREEN:</b> 1.Reports 2.Merch. Params 3.Merch. Options 4.Hosts Params 5.System Options 6.Radio Params 7.Download 8.Communication 9.NOS Menu
2.	<b>Press [6]</b> for Working Mode	<b>SYSTEM OPTIONS:</b> 1.Set Time/Date 2.Edit PIN Key 3.Sel. Mstr Key 4.Set Batch No. 5.Edit Database 6.Working Mode 7.Test Mode 8.Predial Call 9.PinPad Init.
3.	<b>Press [2]</b> for AVS Options.	<b>WORKING MODE:</b> 1.Tip Option 2.AVS Option 3.Card Prsnt Opt 4.Coment Opt.
4.	<b>Input the Password and Press [ENTER]</b>	<b>ENTER PASSWORD:</b>

*Continued on next page*

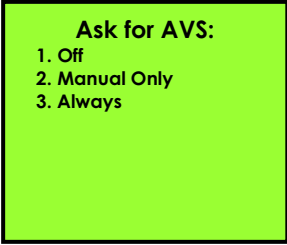
## Working Mode – AVS Options, Continued

STEP	ACTION	DISPLAY
5.	<p><b>Select the desired AVS Option</b></p> <p><b>*Note:</b> See descriptions above</p>	 <p>Ask for AVS: 1. Off 2. Manual Only 3. Always</p>
6.	<p><b>Press Any Key to Complete</b></p>	 <p>Check rates with your bank</p>
7.	<p><b>Stop.</b></p>	



## Working Mode – Card Present Options

### FUNCTION DESCRIPTION

These options are used for verifying if the card is present at the point of Sale.

\* There are three options for Card Present:

- **NO, IF MANUAL** – No prompt to verify card is present on a manual entry. Will prompt for zip code and street address.
- **ALWAYS YES** – No prompt to verify card is present on a manual entry. Will prompt for zip code only.
- **ASK, IF MANUAL** – Will prompt to verify card is present on a manual entry. Will prompt for zip code only if card is present **or** both zip and street address if card is not present.

STEP	ACTION	DISPLAY
1.	From the Main Menu <b>Press [5]</b> to access System Options	<b>MENU SCREEN:</b> 1.Reports 2.Merch. Params 3.Merch. Options 4.Hosts Params 5.System Options 6.Radio Params 7.Download 8.Communication 9.NOS Menu
2.	<b>Press [6]</b> for Working Mode	<b>SYSTEM OPTIONS:</b> 1.Set Time/Date 2.Edit PIN Key 3.Sel. Mstr Key 4.Set Batch No. 5.Edit Database 6.Working Mode 7.Test Mode 8.Predial Call 9.PinPad Init.
3.	<b>Press [3]</b> for Card Present Options.	<b>WORKING MODE:</b> 1.Tip Options 2.AVS Options 3.Card Prsnt Opt 4.Comment Opt.
4.	<b>Input the Password and Press [ENTER]</b>	<b>ENTER PASSWORD:</b>

*Continued on next page.*

## Working Mode – Card Present Options, Continued

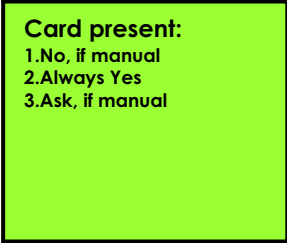
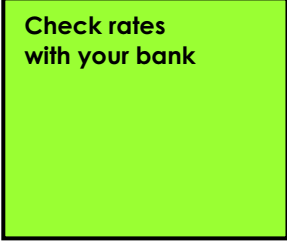
STEP	ACTION	DISPLAY
5.	<p>Select the desired <b>Card Present Option</b>.</p> <p><b>*Note:</b> See descriptions above</p>	 <p>Card present: 1.No, if manual 2.Always Yes 3.Ask, if manual</p>
6.	<p>Press Any Key to Complete.</p>	 <p>Check rates with your bank</p>
7.	<p>Stop.</p>	

## Working Mode – Comment Options

**FUNCTION DESCRIPTION**

Use this option to add a one line – 24 character comment to the receipt between the signature line and the trailer.

STEP	ACTION	DISPLAY
1.	From the Main Menu <b>Press [5]</b> to access System Options	<b>MENU SCREEN:</b> 1.Reports 2.Merch. Params 3.Merch. Options 4.Hosts Params 5.System Options 6.Radio Params 7.Download 8.Communication 9.NOS Menu
2.	<b>Press [6]</b> for Working Mode	<b>SYSTEM OPTIONS:</b> 1.Set Time/Date 2.Edit PIN Key 3.Sel. Mstr Key 4.Set Batch No. 5.Edit Database 6.Working Mode 7.Test Mode 8.Predial Call 9.PinPad Init.
3.	<b>Press [4]</b> for Comment Options.	<b>WORKING MODE:</b> 1.Tip Options 2.AVS Options 3.Card Prsnt Opt 4.Comment Opt.
4.	<b>Input the Password</b> and <b>press [ENTER]</b>	<b>ENTER PASSWORD:</b>
5.	Using the method described in Editing Header, <b>enter</b> the 24-character comment line. <b>Press [ENTER]</b> when the comment has been entered.	<b>Comment Opt. 1 N</b>
6.	<b>Stop.</b>	

# Predial Call

## FUNCTION DESCRIPTION

The terminal can be programmed to start dialing once the credit card is swiped. If pre-dial is turned off, the terminal will start dialing after entering the dollar amount. Ideally, pre-dial saves on transaction time.

STEP	ACTION	DISPLAY
1.	From the Main Menu <b>Press [5]</b> to access System Options	<b>MENU SCREEN:</b> 1.Reports 2.Merch. Params 3.Merch. Options 4.Hosts Params 5.System Options 6.Radio Params 7.Download 8.Communication 9.NOS Menu
2.	<b>Press [8]</b> for Predial Call	<b>SYSTEM OPTIONS:</b> 1.Set Time/Date 2.Edit PIN Key 3.Sel. Mstr Key 4.Set Batch No. 5.Edit Database 6.Working Mode 7.Test Mode 8.Predial Call 9.PinPad Init.
3.	<b>Input the Password</b> and <b>press [ENTER]</b>	<b>ENTER PASSWORD:</b>
4.	<b>Select the EDC type</b> you wish to use Predial for.	<b>CHOOSE EDC TYPE:</b> 1. ALL 2. CREDIT 3. DEBIT
5.	Use the [ <b>▲</b> ] and [ <b>▼</b> ] to scroll between Off and On then <b>press [ENTER]</b> to select.	<b>PREDIAL CALL:</b> 1. OFF 2. ON
6.	<b>Stop.</b>	

## Pin Pad Initialization

**FUNCTION DESCRIPTION** This menu will allow you to set the PIN pad initialization to automatic or manually.

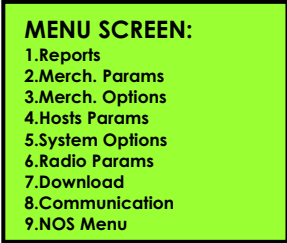
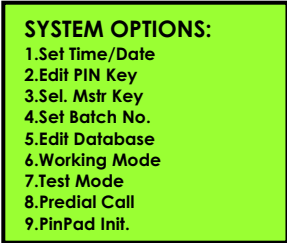
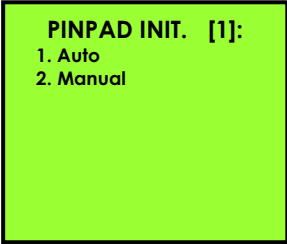
STEP	ACTION	DISPLAY
1.	From the Main Menu <b>Press [5]</b> to access System Options	 <p><b>MENU SCREEN:</b>  1.Reports  2.Merch. Params  3.Merch. Options  4.Hosts Params  5.System Options  6.Radio Params  7.Download  8.Communication  9.NOS Menu</p>
2.	<b>Press [9]</b> for PinPad Initialize	 <p><b>SYSTEM OPTIONS:</b>  1.Set Time/Date  2.Edit PIN Key  3.Sel. Mstr Key  4.Set Batch No.  5.Edit Database  6.Working Mode  7.Test Mode  8.Predial Call  9.PinPad Init.</p>
3.	Use the [ <b>▲</b> ] and [ <b>▼</b> ] to scroll between <b>Auto</b> and <b>Manual</b> then Press [ <b>ENTER</b> ] to select.	 <p><b>PINPAD INIT. [1]:</b>  1. Auto  2. Manual</p>
4.	<b>Stop.</b>	

## Pin Pad Function

**FUNCTION DESCRIPTION** This menu gives option to encrypt terminal manually for the internal PIN Pad.

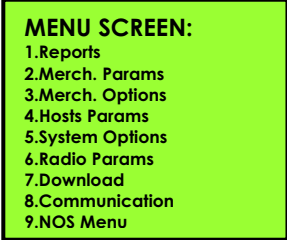
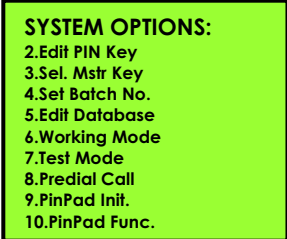
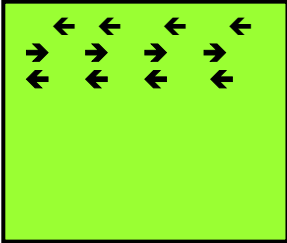
STEP	ACTION	DISPLAY
1.	From the Main Menu <b>Press [5]</b> to access System Options	 <p><b>MENU SCREEN:</b>  1.Reports  2.Merch. Params  3.Merch. Options  4.Hosts Params  5.System Options  6.Radio Params  7.Download  8.Communication  9.NOS Menu</p>
2.	Using the [▼] key scroll down to option # <b>10. Pin Pad func.</b>	 <p><b>SYSTEM OPTIONS:</b>  2.Edit PIN Key  3.Sel. Mstr Key  4.Set Batch No.  5.Edit Database  6.Working Mode  7.Test Mode  8.Predial Call  9.PinPad Init.  10.PinPad Func.</p>
3.	Proceed with the regular encryption process.	
4.	<b>Stop.</b>	

# Pin Pad Configuration

**FUNCTION DESCRIPTION** This menu options allows the terminal to be programmed for an internal PIN Pad or an external PIN Pad.

STEP	ACTION	DISPLAY
1.	From the Main Menu <b>Press [5]</b> to access System Options	<b>MENU SCREEN:</b> 1.Reports 2.Merch. Params 3.Merch. Options 4.Hosts Params 5.System Options 6.Radio Params 7.Download 8.Communication 9.NOS Menu
2.	Using the [ <b>▼</b> ] key scroll down to option <b># 11. Pin Pad Config.</b> then <b>press [ENTER]</b> to select.	<b>SYSTEM OPTIONS:</b> 3.Sel. Mstr Key 4.Set Batch No. 5.Edit Database 6.Working Mode 7.Test Mode 8.Predial Call 9.PinPad Init. 10.PinPad Func. 11.PinPad Config.
3.	<b>Input the Password and Press [ENTER]</b>	<b>ENTER PASSWORD:</b>
4.	<b>Press [1]</b> for internal PinPad  <u>OR</u>  <b>Press [2]</b> for external PinPad	<b>CHOOSE PINPAD:</b> 1- built in 2-ext.
5.	<b>Stop.</b>	

## Status Bar

**FUNCTION DESCRIPTION** This menu options allows you to turn the terminal's status bar display off and on.

STEP	ACTION	DISPLAY
1.	From the Main Menu <b>Press [5]</b> to access System Options	<b>MENU SCREEN:</b> 1.Reports 2.Merch. Params 3.Merch. Options 4.Hosts Params 5.System Options 6.Radio Params 7.Download 8.Communication 9.NOS Menu
2.	Using the [ <b>▼</b> ] key scroll down to option # 12. <b>Status Bar</b> then <b>press [ENTER]</b> to select.	<b>SYSTEM OPTIONS:</b> 4.Set Batch No. 5.Edit Database 6.Working Mode 7.Test Mode 8.Predial Call 9.PinPad Init. 10.PinPad Func. 11.PinPad Config. 12.Status Bar
3.	<b>Press</b> the number that corresponds with the desired selection.	<b>STATUS BAR:</b> 1.OFF 2.ON 3.ON with Time 4.ON with Date
4.	<b>Stop.</b>	



## 6. Radio Params





**MENU DESCRIPTION** This Menu options allows viewing of the terminals radio information. There are three sub-menus in the Radio Params option.

Radio Tests     Print Params     Battery Test

### Radio Tests - RADIO RSSI

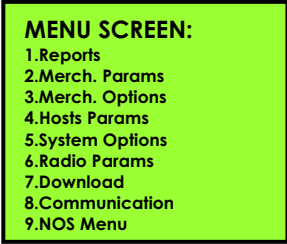

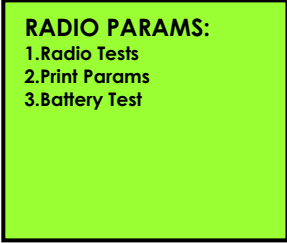
**FUNCTION DESCRIPTION**

This shows the **R**adio **S**ignal **S**trength **I**ndicator. The RSSI should be a thirteen or greater to obtain good reception. The base station will vary, depending on location.

STEP	ACTION	DISPLAY
1.	From the Main Menu <b>Press [6]</b> to access Radio Params	 <p><b>MENU SCREEN:</b>            1.Reports            2.Merch. Params            3.Merch. Options            4.Hosts Params            5.System Options            6.Radio Params            7.Download            8.Communication            9.NOS Menu</p>
2.	Allow a few moments for the terminal to register	 <p><b>PLEASE WAIT</b></p>
3.	<b>Press [1]</b> to access Radio Tests.	 <p><b>RADIO PARAMS:</b>            1.Radio Tests            2.Print Params            3.Battery Test</p>
4.	<b>Press [1]</b> to access Radio RSSI.  <b>Note:</b> The actual RSSI and base station will appear on the display.	 <p><b>RADIO RSSI: 18</b>  <b>BASE STN. : 40</b></p>
5.	<b>Press [MENU]</b> to exit	
6.	<b>Stop.</b>	

## Radio Tests - TERMINAL MAN# (MOBITEX ONLY)

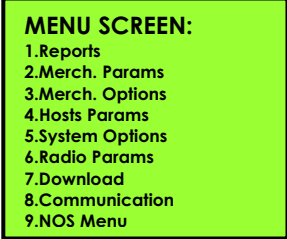

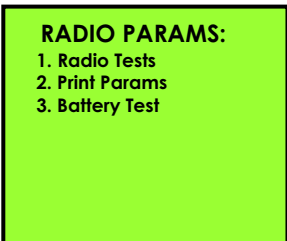
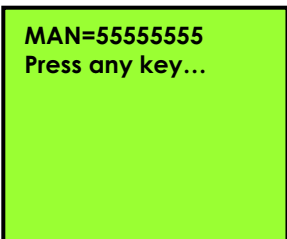

**FUNCTION DESCRIPTION** This submenu function displays the MAN# (Mobitex Access Number) assigned to the terminal's radio.

STEP	ACTION	DISPLAY
1.	From the Main Menu <b>Press [6]</b> to access Radio Params	 <p><b>MENU SCREEN:</b>  1.Reports  2.Merch. Params  3.Merch. Options  4.Hosts Params  5.System Options  6.Radio Params  7.Download  8.Communication  9.NOS Menu</p>
2.	Allow a few moments for the terminal to register	 <p><b>PLEASE WAIT</b></p>
3.	<b>Press [1]</b> to access Radio Tests.	 <p><b>RADIO PARAMS:</b>  1. Radio Tests  2. Print Params  3. Battery Test</p>
4.	<b>Press [2]</b> for Terminal MAN#.	 <p><b>MAN=5555555</b>  Press any key...</p>
5.	<b>Press</b> any key to exit.	
6.	<b>Stop.</b>	

## Radio Tests - Terminal LLI# (Motient Only)

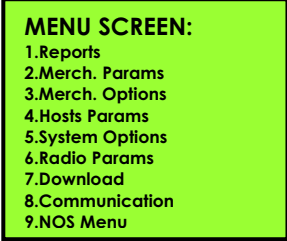

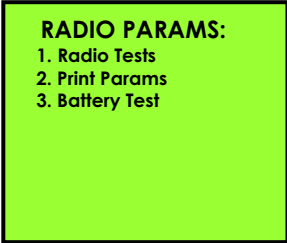
### FUNCTION DESCRIPTION

This submenu function displays the LLI# (Logical Link Indicator) assigned to the terminal's radio. The LLI must be active on the Motient network.

STEP	ACTION	DISPLAY
1.	From the Main Menu <b>Press [6]</b> to access Radio Params	
2.	Allow a few moments for the terminal to register	
3.	<b>Press [1]</b> to access Radio Tests.	
4.	<p><b>Press [2]</b> for Terminal LLI#.</p> <p><b>Note:</b> The RPD ID is the LLI#</p>	
5.	Press any key to exit.	
6.	<b>Stop.</b>	

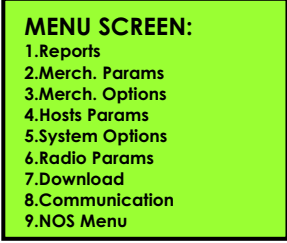

## Radio Tests - Radio Information

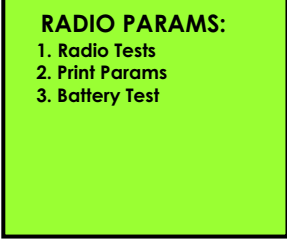
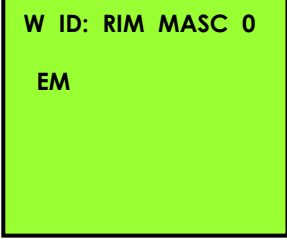
**FUNCTION DESCRIPTION** This submenu function displays information specific to the units radio and is used mainly by technical support.

STEP	ACTION	DISPLAY
1.	From the Main Menu <b>Press [6]</b> to access Radio Params	 <p><b>MENU SCREEN:</b>  1.Reports  2.Merch. Params  3.Merch. Options  4.Hosts Params  5.System Options  6.Radio Params  7.Download  8.Communication  9.NOS Menu</p>
2.	Allow a few moments for the terminal to register	 <p><b>PLEASE WAIT</b></p>
3.	<b>Press [1]</b> to access Radio Tests.	 <p><b>RADIO PARAMS:</b>  1. Radio Tests  2. Print Params  3. Battery Test</p>
4.	<p><b>Press [3]</b> for Radio Info.</p> <p><b>Note:</b> Display will differ</p>	 <p><b>W ID: RIM MASC 0</b>  <b>EM</b></p>
5.	Press any key twice to exit.	
6.	<b>Stop.</b>	

# Print Params

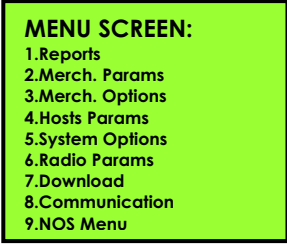

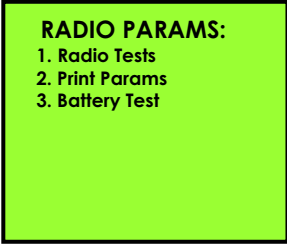
**FUNCTION DESCRIPTION** This menu options allows you to print the radio parameters set for the terminal's radio.

STEP	ACTION	DISPLAY
1.	From the Main Menu <b>Press [6]</b> to access Radio Params	 <p><b>MENU SCREEN:</b>  1.Reports  2.Merch. Params  3.Merch. Options  4.Hosts Params  5.System Options  6.Radio Params  7.Download  8.Communication  9.NOS Menu</p>
2.	Allow a few moments for the terminal to register	 <p><b>PLEASE WAIT</b></p>
3.	<b>Press [2]</b> for Print Params.	 <p><b>RADIO PARAMS:</b>  1. Radio Tests  2. Print Params  3. Battery Test</p>
4.	The Radio Parameter information will print out.	
5.	Press <b>[MENU]</b> to exit.	
6.	<b>Stop.</b>	

# Battery Test

**FUNCTION  
DESCRIPTION**

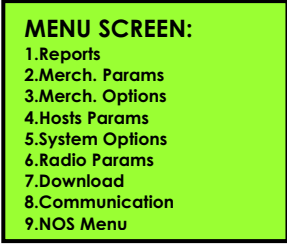
This submenu function displays the current battery strength.

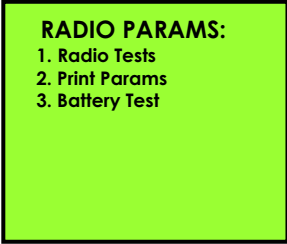
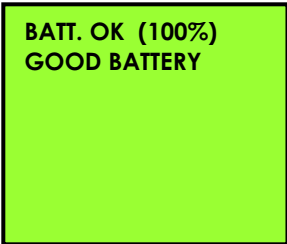
STEP	ACTION	DISPLAY
1.	From the Main Menu <b>Press [6]</b> to access Radio Params.	 <p><b>MENU SCREEN:</b>  1.Reports  2.Merch. Params  3.Merch. Options  4.Hosts Params  5.System Options  6.Radio Params  7.Download  8.Communication  9.NOS Menu</p>
2.	Allow a few moments for the terminal to register.	 <p><b>PLEASE WAIT</b></p>
3.	<b>Press [3]</b> for Battery Test.	 <p><b>RADIO PARAMS:</b>  1. Radio Tests  2. Print Params  3. Battery Test</p>
4.	Press <b>[MENU]</b> three times to exit.	 <p><b>BATT. OK (100%) GOOD BATTERY</b></p>
5.	<b>Stop.</b>	

## 7. Download

This Main Menu has four sub-menus pertaining to programming and reprogramming the terminal. This should only be done under advisement of customer service. Modem downloads cannot be done via RADIO and need to be done connected to a telephone line.

### MENU DESCRIPTION

- Parameters                       Autoload  
 Application Only                 Communication Params

## Download Definitions

**Parameter**      A parameter download is for downloading the merchant's file into the terminal. The information being downloaded is merchant specific. I.e.: Merchant ID, Terminal ID, etc.

**Autoload**        An autoload is used to update or change the current application in the terminal in addition to downloading the merchant's parameters. I.e.: Retail to Restaurant application would require an autoload.

**Application Only**      This option will download only the application information but not the merchant parameters.

## Downloading

### FUNCTION DESCRIPTION

Refer to above information for download definitions.

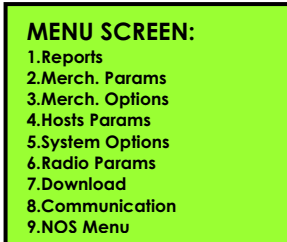
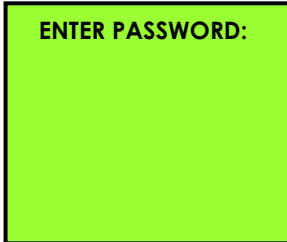
STEP	ACTION	DISPLAY
1.	From the Main Menu <b>Press [7]</b> to access the Download Menu	
2.	<b>Input the Password and press [ENTER]</b>	

*Continued on next page*

## Downloading, Continued

STEP	ACTION	DISPLAY
3.	<p>Press [ENTER] to continue</p> <p><i>Or</i></p> <p>Press [MENU] to exit.</p>	
4.	<p>To download via current setting press [ENTER] and skip to step 9.</p> <p><i>Or</i></p> <p>Press [MENU] to set communication options.</p> <p><b>Note:</b> The current setting will display</p>	
5.	<p>Press [3] to change the download method.</p> <p><b>Note:</b> Continuously pressing [3] will scroll through the available options. Whichever option is selected is the option that will appear on top in parenthesis.</p>	
6.	<p>If downloading via modem press [1] and input the download phone number.</p>	
7.	<p>If an exchange prefix is needed press [2] and input the exchange prefix.</p> <p>And/Or</p> <p>If a suffix is needed press [7] and input the suffix</p>	
8.	<p>Press [MENU] twice after all the communication parameters for the download have been set.</p>	

*Continued on next page*



## Downloading, Continued

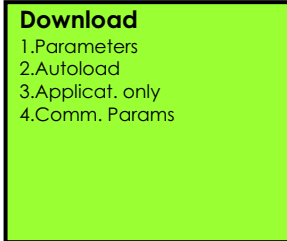

---

STEP	ACTION	DISPLAY
9.	<b>Input</b> the Site ID for the terminal.	
10.	<b>Select</b> the download type by selecting the number that corresponds with the appropriate choice.	
11.	<b>Stop.</b>	

---

## Download – Communication Parameters, Phone

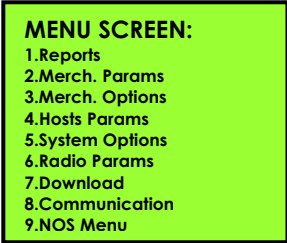
**FUNCTION DESCRIPTION** This menu function allows you to set the communication parameters specifically for downloading the terminal.

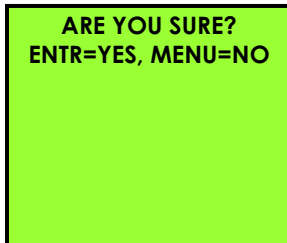
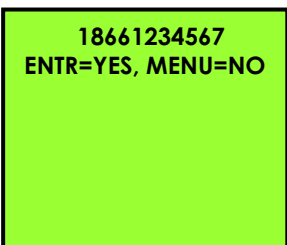
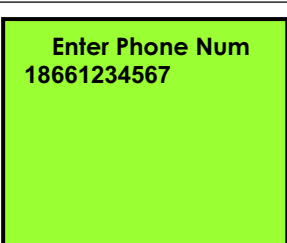
STEP	ACTION	DISPLAY
1.	From the Main Menu <b>Press [7]</b> to access the Download Menu	 <p><b>MENU SCREEN:</b>  1.Reports  2.Merch. Params  3.Merch. Options  4.Hosts Params  5.System Options  6.Radio Params  7.Download  8.Communication  9.NOS Menu</p>
2.	<b>Input the Password and press [ENTER]</b>	 <p><b>ENTER PASSWORD:</b></p>
3.	<p><b>Press [ENTER]</b> to continue</p> <p><i>Or</i></p> <p><b>Press [MENU]</b> to exit</p>	 <p><b>ARE YOU SURE?</b>  <b>ENTR=YES, MENU=NO</b></p>
4.	<b>Press [MENU]</b> to edit the download phone number.	 <p><b>18661234567</b>  <b>ENTR=YES, MENU=NO</b></p>
5.	Input the desired phone number for the download then <b>press [ENTER]</b> .	 <p><b>Enter Phone Num</b>  <b>18661234567</b></p>

*Continued on next page*

## Download – Communication Parameters, Phone, Continued

STEP	ACTION	DISPLAY
6.	Press <b>[MENU]</b> to return to the Download menu	<div style="border: 1px solid black; background-color: #90EE90; padding: 5px;"> <p style="text-align: center;"><b>Download</b></p> <p>1.Parameters 2.Autoload 3.Applicat. only 4.Comm. Params</p> </div>
7.	<b>Stop.</b>	

## Download – Comm Parameters, Exchange Prefix

**FUNCTION DESCRIPTION** This menu function allows you to set a dialing prefix specifically for dialing out to download only.

STEP	ACTION	DISPLAY
1.	From the Main Menu <b>press [7]</b> to access the Download Menu.	<div style="border: 1px solid black; background-color: #90EE90; padding: 5px;"> <p style="text-align: center;"><b>MENU SCREEN:</b></p> <p>1.Reports 2.Merch. Params 3.Merch. Options 4.Hosts Params 5.System Options 6.Radio Params 7.Download 8.Communication 9.NOS Menu</p> </div>
2.	<b>Input the Password</b> and <b>press [ENTER]</b>	<div style="border: 1px solid black; background-color: #90EE90; padding: 5px;"> <p style="text-align: center;"><b>ENTER PASSWORD:</b></p> </div>
3.	<b>Press [ENTER]</b> to continue.	<div style="border: 1px solid black; background-color: #90EE90; padding: 5px;"> <p style="text-align: center;"><b>ARE YOU SURE?</b> NO      YES</p> </div>

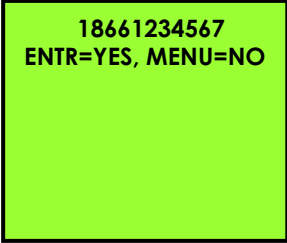
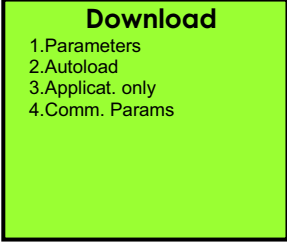
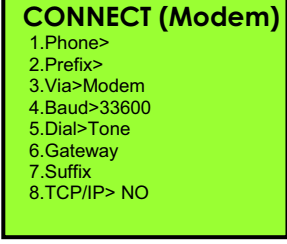
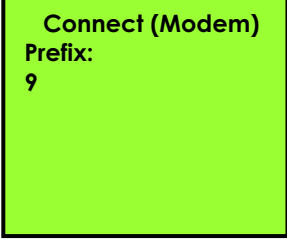
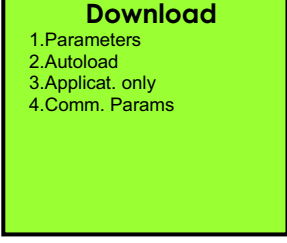

*Continued on next page*

## Download – Comm Parameters, Exchange Prefix, Continued

STEP	ACTION	DISPLAY
4.	Press <b>[ENTER]</b> to continue	 <pre> 18661234567 ENTR=YES, MENU=NO </pre>
5.	Press <b>[4]</b> for Communication Parameters	 <pre> Download 1.Parameters 2.Autoload 3.Applicat. only 4.Comm. Params </pre>
6.	Press <b>[2]</b> and then press <b>[ENTER]</b> for Exchange Prefix	 <pre> CONNECT (Modem) 1.Phone&gt; 2.Prefix&gt; 3.Via&gt;Modem 4.Baud&gt;33600 5.Dial&gt;Tone 6.Gateway 7.Suffix 8.TCP/IP&gt; NO </pre>
7.	Input the desired <b>exchange Prefix</b> then press <b>[ENTER]</b>	 <pre> Connect (Modem) Prefix: 9 </pre>
8.	Press <b>[MENU]</b> to return to the Download menu	 <pre> Download 1.Parameters 2.Autoload 3.Applicat. only 4.Comm. Params </pre>
9.	<b>Stop.</b>	

## Download – Comm Parameters, Via>

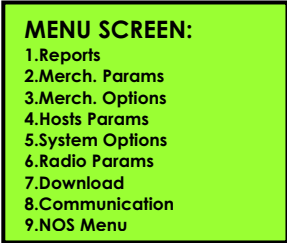
**FUNCTION DESCRIPTION** This menu function allows you to switch download method. *For example: From Modem to Com1.*

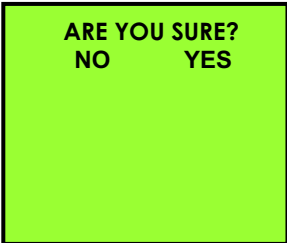
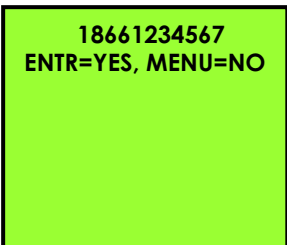
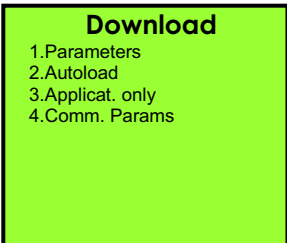
STEP	ACTION	DISPLAY
1.	From the Main Menu <b>press [7]</b> to access the Download Menu.	 <p><b>MENU SCREEN:</b>  1.Reports  2.Merch. Params  3.Merch. Options  4.Hosts Params  5.System Options  6.Radio Params  7.Download  8.Communication  9.NOS Menu</p>
2.	<b>Input the Password</b> and <b>press [ENTER]</b> .	 <p><b>ENTER PASSWORD:</b></p>
3.	<b>Press [ENTER]</b> to continue.	 <p><b>ARE YOU SURE?</b>  NO YES</p>
4.	<b>Press [ENTER]</b> to continue.	 <p><b>18661234567</b>  <b>ENTR=YES, MENU=NO</b></p>
	<b>Press [4]</b> for Communication Parameters.	 <p><b>Download</b>  1.Parameters  2.Autoload  3.Applicat. only  4.Comm. Params</p>

*Continued on next page*

## Download – Comm Parameters, Via>, Continued

STEP	ACTION	DISPLAY
5.	<p>Press [3] for Via&gt;Modem</p> <p><b>Note:</b> Prompts will vary depending on current settings.</p>	<div style="border: 1px solid black; background-color: #90EE90; padding: 5px;"> <p><b>CONNECT (Modem)</b>            1.Phone&gt;            2.Prefix&gt;            3.Via&gt;Ext.Modem            4.Baud&gt;33600            5.Dial&gt;Tone            6.Gateway            7.Suffix            8.TCP/IP&gt; NO</p> </div>
6.	<p>Each time <b>ENTER</b> is pressed the display will toggle through the available download methods. Upon the desired setting press <b>[MENU]</b> to return to the download menu.</p>	<div style="border: 1px solid black; background-color: #90EE90; padding: 5px;"> <p><b>CONNECT (Modem)</b>            1.Phone&gt;            2.Prefix&gt;            3.Via&gt;Modem            4.Baud&gt;33600            5.Dial&gt;Tone            6.Gateway            7.Suffix            8.TCP/IP&gt; NO</p> </div>
7.	<b>Stop.</b>	

## Download – Comm Params, Baud Rate

**FUNCTION DESCRIPTION** This menu function allows you to change the baud rate (Rate that data is exchanged between terminal and modem)

STEP	ACTION	DISPLAY
1.	<p>From the Main Menu Press [7] to access the Download Menu</p>	<div style="border: 1px solid black; background-color: #90EE90; padding: 5px;"> <p><b>MENU SCREEN:</b>            1.Reports            2.Merch. Params            3.Merch. Options            4.Hosts Params            5.System Options            6.Radio Params            7.Download            8.Communication            9.NOS Menu</p> </div>
2.	<p>Input the Password and press [ENTER]</p>	<div style="border: 1px solid black; background-color: #90EE90; padding: 5px;"> <p><b>ENTER PASSWORD:</b></p> </div>

*Continued on next page*

## Download – Comm Params, Baud Rate, Continued

STEP	ACTION	DISPLAY
3.	Press [ENTER] to continue	<pre> ARE YOU SURE? NO      YES           </pre>
4.	Press [ENTER] to continue	<pre> 18661234567 ENTR=YES, MENU=NO           </pre>
5.	Press [4] for Communication Parameters	<pre> Download 1.Parameters 2.Autoload 3.Applicat. only 4.Comm. Params           </pre>
6.	<p>Press [4]</p> <p>Each time [4] is pressed the display will toggle through the available Baud Rates for Download. Upon the desired setting press [MENU] to return to the download menu.</p>	<pre> CONNECT (Modem) 1.Phone&gt; 2.Prefix&gt; 3.Via&gt;Modem 4.Baud&gt;33600 5.Dial&gt;Tone 6.Gateway 7.Suffix 8.TCP/IP&gt; NO           </pre>
7.	<b>Stop.</b>	

## Download – Comm Params, Dial>

**FUNCTION DESCRIPTION** This menu function is specific to the download process it enables you to switch from Dial tone to Pulse if needed.

STEP	ACTION	DISPLAY
1.	From the Main Menu <b>Press [7]</b> to access the Download Menu	<b>MENU SCREEN:</b> 1.Reports 2.Merch. Params 3.Merch. Options 4.Hosts Params 5.System Options 6.Radio Params 7.Download 8.Communication 9.NOS Menu
2.	<b>Input the Password and Press [ENTER]</b>	<b>ENTER PASSWORD:</b>
3.	<b>Press [ENTER]</b> to continue	<b>ARE YOU SURE?</b> NO YES
4.	<b>Press [ENTER]</b> to continue	18661234567 ENTR=YES, MENU=NO
5.	<b>Press [4]</b> for Communication Parameters	<b>Download</b> 1.Parameters 2.Autoload 3.Applicat. only 4.Comm. Params

*Continued on next page*



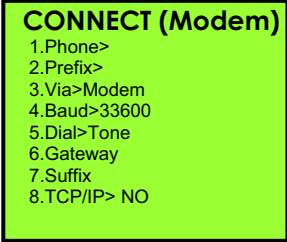

## Download – Comm Params, Dial>, Continued

STEP	ACTION	DISPLAY
6.	<p><b>Press [5]</b></p> <p>Each time [5] is pressed the display will toggle from Tone to Pulse. Upon the desired setting press [MENU] to return to the download menu.</p> <p><b>Note:</b> Prompts will vary depending on current setting.</p>	
7.	<b>Stop.</b>	

## Download – Comm Params, Gateway>

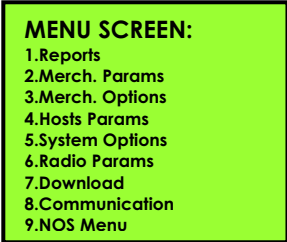
**FUNCTION DESCRIPTION** This menu function allows you to set gateway communication parameters if you are downloading through a gateway.

STEP	ACTION	DISPLAY
1.	From the Main Menu <b>Press [7]</b> to access the Download Menu	
2.	<b>Input the Password</b> and <b>Press [ENTER]</b>	
3.	<b>Press [ENTER]</b> to continue	

Continued on next page.

## Download – Comm Params, Gateway>, Continued

STEP	ACTION	DISPLAY
4.	Press [ENTER] to continue	<pre> 18661234567 ENTR=YES, MENU=NO </pre>
5.	Press [4] for Communication Parameters	<pre> Download 1.Parameters 2.Autoload 3.Applicat. only 4.Comm. Params </pre>
6.	Press [6] for Gateway>	<pre> CONNECT (Modem) 1.Phone&gt; 2.Prefix&gt; 3.Via&gt;Modem 4.Baud&gt;33600 5.Dial&gt;Tone 6.Gateway 7.Suffix 8.TCP/IP&gt; NO </pre>
7.	Input the desired Gateway phone number then press [ENTER]	<pre> CONNECT (Modem) 1.Phone&gt; 2.Exchange Pref&gt; 3.Via&gt;Modem Gateway: 7.Suffix </pre>
8.	Press [MENU] to return to the Download menu	<pre> Download 1.Parameters 2.Autoload 3.Applicat. only 4.Comm. Params </pre>
9.	Stop.	

## Download – Comm Params, Suffix

**FUNCTION DESCRIPTION** This menu function allows a suffix at the end of the download phone number to access an outside line.

STEP	ACTION	DISPLAY
1.	From the Main Menu <b>Press [7]</b> to access the Download Menu	<b>MENU SCREEN:</b> 1.Reports 2.Merch. Params 3.Merch. Options 4.Hosts Params 5.System Options 6.Radio Params 7.Download 8.Communication 9.NOS Menu
2.	<b>Input the Password and Press [ENTER]</b>	<b>ENTER PASSWORD:</b>
3.	<b>Press [ENTER]</b> to continue	<b>ARE YOU SURE?</b> NO YES
4.	<b>Press [ENTER]</b> to continue	18661234567 ENTR=YES, MENU=NO
5.	<b>Press [4]</b> for Communication Parameters	<b>Download</b> 1.Parameters 2.Autoload 3.Applicat. only 4.Comm. Params
6.	<b>Press [7]</b> and then <b>press [ENTER]</b> for Suffix>	<b>CONNECT (Modem)</b> 1.Phone> 2.Prefix> 3.Via>Modem 4.Baud>33600 5.Dial>Tone 6.Gateway 7.Suffix 8.TCP/IP> NO

## Download – Comm Params, Suffix, Continued

STEP	ACTION	DISPLAY
7.	Input the desired <b>Suffix</b> then press <b>[ENTER]</b>	<div style="border: 1px solid black; padding: 5px;"> <p><b>CONNECT (Modem)</b>            1.Phone&gt;            2.Exchange Pref&gt;            3.Via&gt;Modem</p> <hr/> <p><b>Suffix:</b></p> <hr/> <p>7.Suffix</p> </div>
8.	Press <b>[MENU]</b> to return to the Download menu	<div style="border: 1px solid black; padding: 5px;"> <p><b>Download</b>            1.Parameters            2.Autoload            3.Applicat. only            4.Comm. Params</p> </div>
9.	<b>Stop.</b>	

## 8. Communication

This Main Menu has eight sub-menus pertaining to communication.

<b>MENU DESCRIPTION</b>	<input type="checkbox"/> Min. Retries	<input type="checkbox"/> Dial: Tone	<input type="checkbox"/> Exchange Prefix	<input type="checkbox"/> Gateway
	<input type="checkbox"/> Suffix	<input type="checkbox"/> Via Line/Radio	<input type="checkbox"/> Check Line	<input type="checkbox"/> Dial Tone Check

### Minimum Retries

**FUNCTION DESCRIPTION** This submenu function allows you to set the amount of times the terminal dials for authorization or batching.

STEP	ACTION	DISPLAY
1.	From the Main Menu <b>press [8]</b> to access Communication.	<div style="border: 1px solid black; background-color: #90EE90; padding: 5px;"> <b>MENU SCREEN:</b>                      1.Reports                      2.Merch. Params                      3.Merch. Options                      4.Hosts Params                      5.System Options                      6.Radio Params                      7.Download                      8.Communication                      9.NOS Menu                 </div>
2.	<b>Press [1]</b>	<div style="border: 1px solid black; background-color: #90EE90; padding: 5px;"> <b>COMM MENU</b>                      1. Min. retries&gt;                      2. DIAL : TONE                      3. Exchange Pref&gt;                      4. Gateway&gt;                      5. Suffix&gt;:                      6. Via:Line/Radio                      7. CHK LINE: ON                      8. D. ToneChk: ON                 </div>
3.	Input the Minimum # of tries then <b>press [ENTER]</b> .	<div style="border: 1px solid black; background-color: #90EE90; padding: 5px;"> <b>COMM MENU</b>                      1. Min. Retries&gt;                      2. DIAL : TONE                 </div> <div style="border: 1px solid black; background-color: #90EE90; padding: 5px; margin-top: 5px;"> <b>Min Num Tries:</b>                      1                 </div> <div style="border: 1px solid black; background-color: #90EE90; padding: 5px; margin-top: 5px;">                     7. CHK LINE: ON                      8. D. ToneChk: ON                 </div>
4.	<b>Stop.</b>	

## Dial: Tone/Pulse

**FUNCTION DESCRIPTION** This submenu function allows you to set the terminal to dial via pulse or touch-tone.

STEP	ACTION	DISPLAY
1.	From the Main Menu <b>Press [8]</b> to access Communication.	<b>MENU SCREEN:</b> 1.Reports 2.Merch. Params 3.Merch. Options 4.Hosts Params 5.System Options 6.Radio Params 7.Download 8.Communication 9.NOS Menu
2.	<b>Press [2]</b> for Dial: options.	<b>COMM MENU:</b> 1. Min. Retries> 2. DIAL : TONE 3. Exchange Pref> 4. Gateway> 5. Suffix>: 6. Via:Line/Radio 7. CHK LINE: ON 8. D. ToneChk: ON
3.	<b>Press [1]</b> for Tone <u>Or</u> <b>Press [2]</b> for Pulse	<b>DIAL TYPE:</b> 1.Tone 2.Pulse
4.	<b>Stop.</b>	

## Exchange Prefix

**FUNCTION DESCRIPTION** This submenu function allows you to program the terminal to dial an exchange prefix before a phone number, when needed.

STEP	ACTION	DISPLAY
1.	From the Main Menu <b>Press [8]</b> to access Communication.	<b>MENU SCREEN:</b> 1.Reports 2.Merch. Params 3.Merch. Options 4.Hosts Params 5.System Options 6.Radio Params 7.Download 8.Communication 9.NOS Menu
2.	<b>Press [3]</b> for Exchange Prefix.	<b>COMM MENU</b> 1. Min. Retries> 2. DIAL : TONE 3. Exchange Pref> 4. Gateway> 5. Suffix>: 6. Via:Line/Radio 7. CHK LINE: ON 8. D. ToneChk: ON
3.	<b>Press [2]</b> to add an exchange prefix.	<b>EXCHANGE PREFIX</b> 1. No 2. Yes
4.	<b>Input the exchange prefix then Press [Enter]</b>	<b>EXCHANGE PREFIX</b> 1. No 2. Yes <hr/> <b>ENTER PREFIX:</b> 9 <hr/>
5.	<b>Stop.</b>	

# Gateway



**FUNCTION DESCRIPTION** This menu option allows you to set communication parameters for processing transactions through a gateway.

STEP	ACTION	DISPLAY
1.	From the Main Menu <b>Press [8]</b> to access Communication.	<b>MENU SCREEN:</b> 1.Reports 2.Merch. Params 3.Merch. Options 4.Hosts Params 5.System Options 6.Radio Params 7.Download 8.Communication 9.NOS Menu
2.	<b>Press [4]</b> for Gateway.	<b>COMM MENU</b> 1. Min. Retries> 2. DIAL : TONE 3. Exchange Pref> 4. Gateway> 5. Suffix:> 6. Via:Line/Radio 7. CHK LINE: ON 8. D. ToneChk: ON
3.	<b>Press [2]</b> then <b>press [ENTER]</b> to input the gateway phone number.	<b>Gateway&gt;</b> 1. No 2. Yes
4.	<b>Input</b> the Gateway phone number then <b>Press [Enter]</b>	<b>Gateway&gt;</b> 1. No 2. Yes <hr/> <b>ENTER GATEWAY:</b> <hr/>
5.	<b>Stop.</b>	



# Suffix

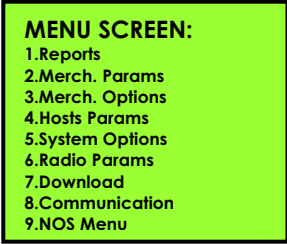

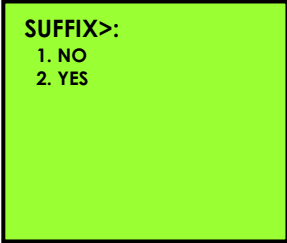
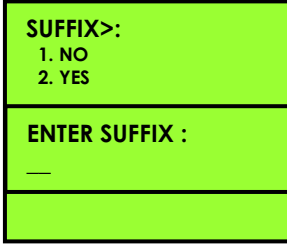
**FUNCTION DESCRIPTION** This submenu function allows you to program the terminal to dial a suffix after a phone number, when needed.

STEP	ACTION	DISPLAY
1.	From the Main Menu <b>Press [8]</b> to access Communication.	 <p><b>MENU SCREEN:</b>  1.Reports  2.Merch. Params  3.Merch. Options  4.Hosts Params  5.System Options  6.Radio Params  7.Download  8.Communication  9.NOS Menu</p>
2.	<b>Press [5]</b> for Suffix.	 <p><b>COMM MENU</b>  1. Min. Retries&gt;  2. DIAL : TONE  3. Exchange Pref&gt;  4. Gateway&gt;  5. Suffix&gt;  6. Via:Line/Radio  7. CHK LINE: ON  8. D. ToneChk: ON</p>
3.	<b>Press [2]</b> then press <b>[ENTER]</b> to add a suffix.	 <p><b>SUFFIX&gt;:</b>  1. NO  2. YES</p>
4.	<b>Input the Suffix</b> then <b>press [Enter]</b>	 <p><b>SUFFIX&gt;:</b>  1. NO  2. YES</p> <p><b>ENTER SUFFIX :</b>  —</p>
5.	<b>Stop.</b>	

## Via Line/Radio

### FUNCTION DESCRIPTION

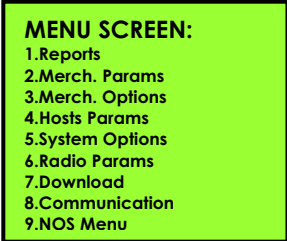
This will program the terminal to process a transaction by radio first. If no signal is received, the terminal will look for a phone line. (This functionality is only available when the NURIT 8000 SECURE is connected to the external Modem.) If the terminal will only be using a phone line, because there is no signal in the area, then it can be programmed for phone Line Only.

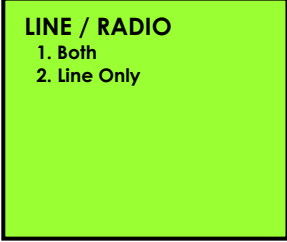
STEP	ACTION	DISPLAY
1.	From the Main Menu <b>Press [8]</b> to access Communication.	
2.	<b>Press [6]</b> for Via: Line/Radio.	
3.	<b>Press [1]</b> for both Radio and Phone Line. <i>Or</i> <b>Press [2]</b> for phone line only.	
4.	After the selection has been made <b>press [ENTER]</b>	
5.	<b>Stop.</b>	

### The options are:

**Via: Both** – Will try to connect via the Radio first then via the phone line if radio is unsuccessful.

**Via: Line Only** – The terminal will dial out using only a Phone line.

## CHECK LINE: ON

### FUNCTION DESCRIPTION

This menu function tells the terminal to check for a phone line when attempting to dial out. (This functionality is only available when the NURIT 8000 SECURE is connected to the external Modem)

STEP	ACTION	DISPLAY
1.	From the Main Menu <b>Press [8]</b> to access Communication.	<b>MENU SCREEN:</b> 1.Reports 2.Merch. Params 3.Merch. Options 4.Hosts Params 5.System Options 6.Radio Params 7.Download 8.Communication 9.NOS Menu
2.	<b>Press [6]</b> for Via: Line/Radio.	<b>COMM MENU</b> 1. Min. Retries> 2. DIAL : TONE 3. Exchange Pref> 4. Gateway> 5. Suffix>: 6. Via:Line/Radio 7. CHK LINE: OFF 8. D. ToneChk: OFF
3.	Each time <b>ENTER</b> is pressed the display will toggle between OFF & ON. Upon desired setting <b>press [MENU]</b> to go back to the idle prompt.	<b>COMM MENU</b> 1. Min. Retries> 2. DIAL : TONE 3. Exchange Pref> 4. Gateway> 5. Suffix>: 6. Via:Line/Radio 7. CHK LINE: ON 8. D. ToneChk: OFF
4.	<b>Stop.</b>	

## CHECK LINE: ON

### FUNCTION DESCRIPTION

This menu function tells the terminal to check for a phone line when attempting to dial out. (This functionality is only available when the NURIT 8000 SECURE is connected to the external Modem)

STEP	ACTION	DISPLAY
5.	From the Main Menu <b>Press [8]</b> to access Communication.	<b>MENU SCREEN:</b> 1.Reports 2.Merch. Params 3.Merch. Options 4.Hosts Params 5.System Options 6.Radio Params 7.Download 8.Communication 9.NOS Menu
6.	<b>Press [6]</b> for Via: Line/Radio.	<b>COMM MENU</b> 1. Min. Retries> 2. DIAL : TONE 3. Exchange Pref> 4. Gateway> 5. Suffix>: 6. Via:Line/Radio 7. CHK LINE: OFF 8. D. ToneChk: OFF
7.	Each time <b>ENTER</b> is pressed the display will toggle between OFF & ON. Upon desired setting <b>press [MENU]</b> to go back to the idle prompt.	<b>COMM MENU</b> 1. Min. Retries> 2. DIAL : TONE 3. Exchange Pref> 4. Gateway> 5. Suffix>: 6. Via:Line/Radio 7. CHK LINE: ON 8. D. ToneChk: OFF
8.	<b>Stop.</b>	

## Appendix A – Restaurant Tips and Tabs

### Working Mode – TIP OPTIONS

**FUNCTION DESCRIPTION**

This option allows you to include up to three tips per transaction. This option will also allow you to name the tip type for identification. For Tip Discounting, the option **must be enabled** for each of the three tips where it is required.

The default tip amount will automatically be added to the transaction if a New Rate amount is entered for tips 2 & 3. For the Tip #1 default tip amount to be added, the tip option must be set for “In Transaction”.

**Note:** For Restaurant, Tip #1 cannot be disabled.

STEP	ACTION	DISPLAY
1.	From the Main MENU SCREEN <b>press [5]</b> to access System Options.	<b>MENU SCREEN:</b> 1.Reports 2.Merch. Params 3.Merch. Options 4.Hosts Params 5.System Options 6.Radio Params 7.Download 8.Communication 9.NOS Menu
2.	<b>Press [6]</b> for Working Mode	<b>SYSTEM OPTIONS:</b> 1.Set Time/Date 2.Edit PIN Key 3.Sel. Mstr Key 4.Set Batch No. 5.Edit Database 6.Working Mode 7.Test Mode 8.Predial Call 9.PinPad Init.
3.	<b>Press [1]</b> for Tip Options.	<b>WORKING MODE:</b> 1.Tip Option 2.AVS Option 3.Card Prsnt Opt 4.Cpmmnt Opt.
4.	<b>Input the Password</b> and <b>Press [ENTER]</b>	<b>ENTER PASSWORD:</b>

*Continued on next page*

# Working Mode – Tip Options, Continued

STEP	ACTION	DISPLAY
5.	<p>Use the [▲] and [▼] to scroll through tips options, find the tip that you wish to edit and then <b>press [ENTER]</b>.</p> <p style="text-align: center;"><i>Or</i></p> <p><b>Press</b> the number corresponding with your selection.</p> <p><b>Note:</b> The current status is displayed in parenthesis.</p>	<div style="border: 1px solid black; background-color: #90EE90; padding: 5px;"> <p><b>TIP OPTIONS:</b></p> <ol style="list-style-type: none"> <li>1. Tip 1: (ON)</li> <li>2. Tip 2: (OFF)</li> <li>3. Tip 3: (OFF)</li> <li>4. Tab op</li> </ol> </div>
6.	<p>Use the [▲] and [▼] to scroll between Off and On then <b>press [ENTER]</b> to select.</p> <p><b>Note:</b> Though Tip #1 is already on, select on to continue.</p>	<div style="border: 1px solid black; background-color: #90EE90; padding: 5px;"> <p><b>Tip 1 (ON)</b></p> <ol style="list-style-type: none"> <li>1. OFF</li> <li>2. ON</li> </ol> </div>
7.	<p>Using the method described in Editing Header, <b>enter</b> the 13-character tip designation. <b>Press [ENTER]</b> when the name has been entered.</p> <p><b>Press [ENTER]</b> without the modification to keep the existing name.</p>	<div style="border: 1px solid black; background-color: #90EE90; padding: 5px;"> <p><b>TIP 1 Name: 1 N Tip</b></p> </div>
8.	<p>Use the [▲] and [▼] to scroll between Off and On then <b>press [ENTER]</b> to select.</p> <p><b>Note:</b> To have the tip discount calculated, there must be a Tip Discount percentage under Report Setup in the Report Menu.</p>	<div style="border: 1px solid black; background-color: #90EE90; padding: 5px;"> <p><b>Discounted Tip:</b></p> <ol style="list-style-type: none"> <li>1.OFF</li> <li>2.ON</li> </ol> </div>
9.	<p>Use the [▲] and [▼] to scroll between the settings then <b>press [ENTER]</b> to select.</p> <p><b>Note:</b> See setting description below.</p>	<div style="border: 1px solid black; background-color: #90EE90; padding: 5px;"> <p><b>TIP 1 OPTIONS:</b></p> <ol style="list-style-type: none"> <li>1.In Tip Menu</li> <li>2.In Transaction</li> <li>3.Auto Percent</li> </ol> </div>
10.	<p>If Auto Percent is selected, <b>enter</b> the low tip percentage then <b>press [ENTER]</b>.</p>	<div style="border: 1px solid black; background-color: #90EE90; padding: 5px;"> <p><b>TIP 1 OPTIONS:</b></p> <ol style="list-style-type: none"> <li>1.In Tip Menu</li> <li>2.In Transaction</li> <li>3.Auto Percent</li> </ol> <hr/> <p style="text-align: center;"><b>LOW % OF SUM</b></p> <p style="text-align: center;">0</p> </div>



## Tip Options, Continued

STEP	ACTION	DISPLAY
11.	Enter the high tip percentage then press [ENTER].	<div style="border: 1px solid black; padding: 5px;"> <p><b>TIP 1 OPTIONS:</b>            1.In Tip Menu            2.In Transaction            3.Auto Percent</p> <hr/> <p><b>HIGH % OF SUM</b>            0</p> </div>
12.	If desired, enter the default tip amount then press [ENTER].  <i>Or</i>  Press [ENTER] to bypass.	<div style="border: 1px solid black; padding: 5px;"> <p>Tip : \$0.00            New Rate: 0.00</p> </div>
13.	<b>Stop.</b>	

**In Tip Menu** – Will not prompt for a tip amount when entering the transaction and will print a blank tip line on the receipt.



**In Transaction** – Will prompt for a tip amount when entering the transaction. Entered amount will print on the receipt. Pressing [ENTER] at prompt will bypass tip entry and will print a blank tip line.

**Auto Percent** – Will not prompt for a tip amount when entering the transaction and will print a blank tip line with suggested tip amount(s) below.

# Add Tips

## FUNCTION DESCRIPTION

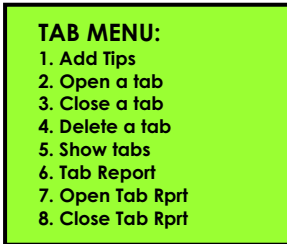
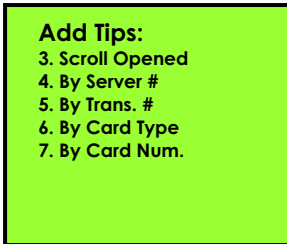
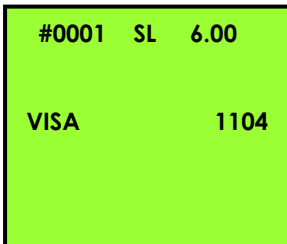
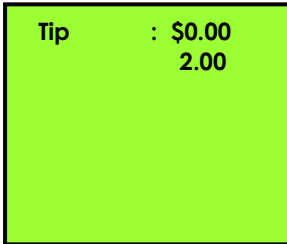
This menu function allows you to go in and add the tips to a transaction in the terminal's database. This is used for Restaurant transactions only.



STEP	ACTION	DISPLAY
1.	From the idle prompt press the <b>[F]</b> and <b>[MENU/CANCEL]</b> keys at the same time to access the Tab Menu then <b>press [1]</b> for Add Tips.	
2.	There are several options for editing and adding tips*, use the arrow keys <b>[▼]</b> <b>[▲]</b> to make your selection then <b>press [ENTER]</b> . <i>Or</i> <b>Press</b> the number corresponding with your selection.	
3.	Use the <b>[▼]</b> and <b>[▲]</b> keys to scroll through the transactions.  When the desired transaction is displayed <b>press [ENTER]</b> to be prompted to add the tip amount.	
4.	Key in the tip amount then <b>press [ENTER]</b> .	
5.	If the amount of the entered tip exceeds to the <b>Overage Tip</b> parameter (defaults to <b>20%</b> in the software model), a warning message is briefly displayed.	

Continued on next page.

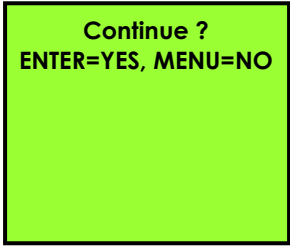

## Add Tips, Continued

---

STEP	ACTION	DISPLAY
6.	Press <b>[ENTER]</b> to accept the overage amount and continue or <b>[MENU]</b> to re-enter the tip amount.	
7.	The total transaction amount will appear briefly.	
8.	<b>Stop</b>	

**\*Note:** Scroll Opened will display only untipped transactions and therefore cannot be used when adjusting a transaction with an existing tip.



---

## Working Mode – Tab Option

STEP	ACTION	DISPLAY
1.	From the Main MENU SCREEN <b>press [5]</b> to access System Options.	<b>MENU SCREEN:</b> 1.Reports 2.Merch. Params 3.Merch. Options 4.Hosts Params 5.System Options 6.Radio Params 7.Download 8.Communication 9.NOS Menu
2.	<b>Press [6]</b> for Working Mode	<b>SYSTEM OPTIONS:</b> 1.Set Time/Date 2.Edit PIN Key 3.Sel. Mstr Key 4.Set Batch No. 5.Edit Database 6.Working Mode 7.Test Mode 8.Predial Call 9.PinPad Init.
3.	<b>Press [1]</b> for Tip Options.	<b>WORKING MODE:</b> 1.Tip Option 2.AVS Option 3.Card Prsnt Opt 4.Comment Opt.
4.	<b>Input the Password and Press [ENTER]</b>	<b>ENTER PASSWORD:</b>
5.	<b>Press [4]</b> for Tab Option.	<b>TIP OPTIONS:</b> 1. Tip 1: (ON) 2. Tip 2: (OFF) 3. Tip 3: (OFF) 4. Tab Option
6.	<b>Press [ENTER]</b> to keep the current default tab amount or <b>enter</b> desired amount then <b>press [ENTER]</b> .	<b>Tab Amt: \$ 50.00</b> <b>0.00</b>
7.	<b>Stop.</b>	

# Open a Tab

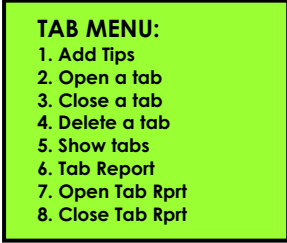
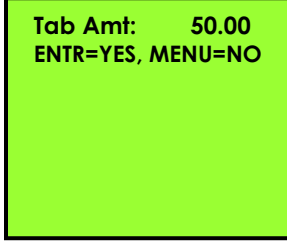
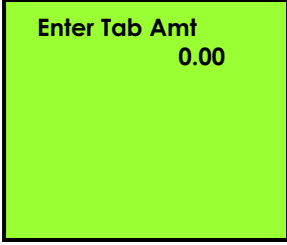
**FUNCTION DESCRIPTION** This menu function allows you to start or “open” a tab using a preset amount.

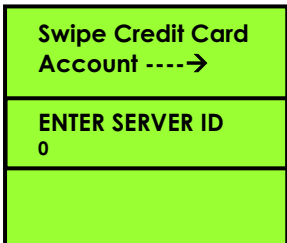
STEP	ACTION	DISPLAY
1.	From the idle prompt press the <b>[F]</b> and <b>[MENU/CANCEL]</b> keys at the same time to access the Tab Menu then <b>press [2]</b> for Open a tab.	
2.	If the default preset tab amount is correct <b>press [ENTER]</b> and <b>skip</b> to step 4.  <i>Or</i> If you wish to change the preset amount <b>press [MENU]</b> and <b>proceed</b> to step 3.	
3.	Input the correct Tab Amount then <b>press [ENTER]</b>	
4.	Swipe the credit card. Upon approval the terminal will open the tab and assign it a number.	
5.	If prompted, enter the server ID.  <b>Using the stylus, have the customer sign on the touch screen display.</b>	
6.	<b>Stop</b>	

## Close a Tab

### FUNCTION DESCRIPTION

This menu function allows you to close a tab. If tab is more than preset amount, it will close for full amount, dialing automatically to host. This will give you two transactions.

STEP	ACTION	DISPLAY
1.	From the idle prompt press the <b>[F]</b> and <b>[MENU/CANCEL]</b> keys at the same time to access the Tab Menu then <b>press [3]</b> for Close a tab.	<b>TAB MENU:</b> 1. Add Tips 2. Open a tab 3. Close a tab 4. Delete a tab 5. Show tabs 6. Tab Report 7. Open Tab Rprt 8. Close Tab Rprt
2.	There are several options for closing a tab, use the arrow keys [ <b>▼</b> ] [ <b>▲</b> ] to make your selection.  <i>Or</i> <b>Press</b> the number corresponding with your selection.	<b>Close a tab</b> 3. Scroll Opened 4. By Server # 5. By Trans. # 6. By Card Type 7. By Card Num.
3.	Input the transaction # for the open tab then <b>press [ENTER]</b> .  <b>Note:</b> The display will vary depending on selection	<b>Close a tab</b> 3. Scroll Opened 4. By Server # 5. By Trans. # <hr/> <b>Transaction # ?</b> <hr/>
4.	When the open tab displays press <b>[ENTER]</b> to continue.	#0002 OP 0.00 Auth. For 50.00 MasterCard 0803
5.	Input the closing tab amount then press <b>[ENTER]</b>	<b>Enter Tab Amt</b> 0.00

Continued on next page

## Close a Tab, Continued

---

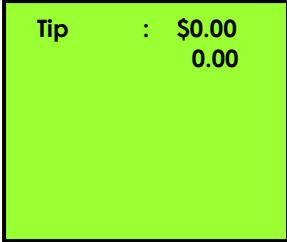
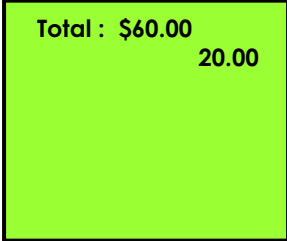
STEP	ACTION	DISPLAY
6.	The terminal will process the total tab amount then prompt you to add a tip amount. <b>Input</b> the tip amount then <b>press [ENTER]</b>	 <pre>Tip      : \$0.00           0.00</pre>
7.	The total amount will appear briefly and then the display will return to the idle Prompt.	 <pre>Total : \$60.00           20.00</pre>
8.	<b>Stop</b>	

# Delete a Tab

## FUNCTION DESCRIPTION

This menu function allows you to delete (void) a tab.

STEP	ACTION	DISPLAY
1.	From the idle prompt press the <b>[F]</b> and <b>[MENU/CANCEL]</b> keys at the same time to access the Tab Menu then <b>press [4]</b> for Delete a tab.	<b>TAB MENU:</b> 1. Add Tips 2. Open a tab 3. Close a tab 4. Delete a tab 5. Show tabs 6. Tab Report 7. Open Tab Rprt 8. Close Tab Rprt
2.	There are several options for closing a tab, use the arrow keys [ <b>▼</b> ] [ <b>▲</b> ] to make your selection  <i>Or</i> <b>Press</b> the number corresponding with your selection.	<b>Delete a tab</b> 3. Scroll Opened 4. By Server # 5. By Trans. # 6. By Card Type 7. By Card Num.
3.	Input the transaction # for the tab you wish to Void (delete) then <b>press [ENTER]</b> .	<b>Delete a tab</b> Transaction # ?
4.	When transaction displays press <b>[ENTER]</b> to continue.	#0002 TAB 0.00 Auth. For 50.00 MasterCard 0803
5.	<b>Input the Password and Press [ENTER]</b>	<b>ENTER PASSWORD:</b>
6.	<b>Press [ENTER] for YES</b> <i>Or</i> <b>Press [MENU] for NO</b>  <b>Note:</b> The actual Trans # will display.	<b>Void Trns #2 ?</b> <b>ENTR=YES, MENU=NO</b>
7.	<b>Stop</b>	

## Show Tabs

**FUNCTION DESCRIPTION** This menu option allows you to scroll through all tabs in the terminal database.

STEP	ACTION	DISPLAY
1.	From the idle prompt press the <b>[F]</b> and <b>[MENU/CANCEL]</b> keys at the same time to access the Tab Menu then <b>press [5]</b> for Show tabs.	<pre> <b>TAB MENU:</b> 1. Add Tips 2. Open a tab 3. Close a tab 4. Delete a tab 5. Show tabs 6. Tab Report 7. Open Tab Rprt 8. Close Tab Rprt           </pre>
2.	There are several options for closing a tab, use the arrow keys [ <b>▼</b> ] [ <b>▲</b> ] to make your selection  <i>Or</i> <b>Press</b> the number corresponding with your selection.	<pre> <b>Delete a tab</b> 3. Scroll Opened 4. By Server # 5. By Trans. # 6. By Card Type 7. By Card Num.           </pre>
3.	Use the arrow keys [ <b>▼</b> ] [ <b>▲</b> ] to scroll through and view the open tabs in the terminal's database.	<pre> #0002  OP    0.00 Auth.  For   50.00 MasterCard  0803           </pre>
4.	<b>Press [MENU]</b> to exit.	
5.	<b>Stop.</b>	

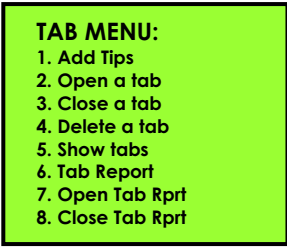
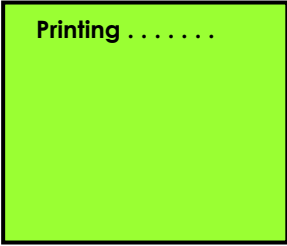

## Tab Report

**FUNCTION DESCRIPTION** This menu option allows you to print a report of all tabs in the terminal database regardless of their status.

STEP	ACTION	DISPLAY
1.	From the idle prompt press the <b>[F]</b> and <b>[MENU/CANCEL]</b> keys simultaneously to access the Tab Menu then <b>Press [6]</b> for Tab Report.	 <p><b>TAB MENU:</b>            1. Add Tips            2. Open a tab            3. Close a tab            4. Delete a tab            5. Show tabs            6. Tab Report            7. Open Tab Rprt            8. Close Tab Rprt</p>
2.	The tab report will begin printing.	 <p>Printing .....</p>
3.	<b>Stop.</b>	

## Open Tab Report

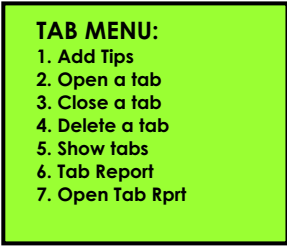
**FUNCTION DESCRIPTION** This menu option allows you to print a report of all open tabs in the terminal database.

STEP	ACTION	DISPLAY
1.	From the idle prompt press the <b>[F]</b> and <b>[MENU/CANCEL]</b> keys at the same time to access the Tab Menu then <b>press [7]</b> for Open Tab Report.	 <p><b>TAB MENU:</b>            1. Add Tips            2. Open a tab            3. Close a tab            4. Delete a tab            5. Show tabs            6. Tab Report            7. Open Tab Rprt</p>
2.	The Open tab report will begin printing.	 <p>Printing .....</p>
3.	<b>Stop.</b>	



# Close Tab Report

---

**FUNCTION DESCRIPTION** This menu option allows you to print a report of all open tabs in the terminal database.

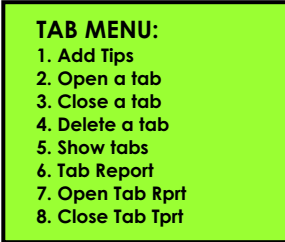
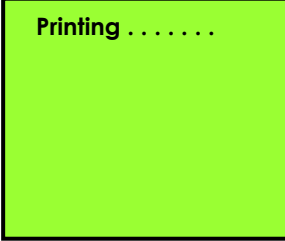
STEP	ACTION	DISPLAY
1.	From the idle prompt press the <b>[F]</b> and <b>[MENU/CANCEL]</b> keys at the same time to access the Tab Menu then <b>press [8]</b> for Close Tab Report.	
2.	The close tab report will begin printing.	
3.	<b>Stop.</b>	

---

**POS STD and PLUS - NURIT 8000 SECURE QUICK REFERENCE GUIDE**

To access the menu, press the [MENU] key. This key will enter and exit out of the menu. Use the [▲] and [▼] key to scroll the menu options.

<b>1. REPORTS</b>		
1.	DEFAULT REPORT	Prints programmed default report.
2.	CURRENT REPORT	Prints a report of the current transactions: Offers several options: Used to change default report setup.
3.	HISTORY REPORT	Prints previous batch totals: Prints Combined or Per Batch totals: Maximum of 30 days.
4.	DISPLAY TRANS.	Displays current transactions offering different sorting options.
5.	RECEIPT COPY	Prints a copy of the last approved receipt. (Transaction must be last function performed.)
6.	PERFORMANCE	Prints percentage of Approvals, Denials, Disconnects, Manual Entries and Swipes: Reset option.
7.	TIP REPORT	Prints tip details for all servers or a specific server.
8.	REPORT SETUP	Offers option to print Visa/MC transactions together or separately: Setup tip discount.
9.	RAM DISK REPORT *	Prints a report listing the RAM Disk Size and max number of transactions for each EDC type.
10.	COMMUNICATIONS LOG REPORT *	Use this function to either print a communication log of the last transaction or batch processed or to clear the log.
<b>2. MERCHANT PARAMS</b>		
1.	AUTHORIZATION	Enables/disables different card and transaction types: Debit mode.
2.	SECURITY LEVEL	Sets security levels for different operations.
3.	EDIT HEADER	Edits the five line, 24 character header.
4.	EDIT TRAILER	Edits the five line, 24 character trailer.
5.	SET CASH EDC	Enables/disables recording of cash transactions.
6.	MERCHANT FEE	Enables and sets the surcharge rate for debit transactions.
7.	SET BATCH TIME	For Host Capture/Autobatch terminals, sets time terminal will print batch report.
8.	SERVER/INVOICE	Enables/disables Server, Invoice, Table and Guest No. Modes. (Table and guest for restaurant only).
9.	SITE ID	View or change Site ID.
<b>3. MERCHANT OPTIONS</b>		
1.	PAPER TYPE	Offers choice between single ply, double ply or custom (two receipts for debit).
2.	NO PAPER MODE	Disables print function (integrated or stand alone).
3.	BUZZER SET	Enables/disables tone when pressing keypad.
4.	OPERATION MODE	Toggles between Normal and Demo Modes.
5.	BATTERY SAVER	Offers option of turning Radio Only, Terminal Only, Radio and Terminal or neither off after a period of inactivity.
6.	PRINT DISCLAIMER	Enables/disables print of the disclaimer on each receipt.
7.	SET MENU TYPE	Toggles between manual scroll and auto scroll.
8.	SET HALO	Maximum dollar limit for a Sale, Return or Cash Back.
9.	PRINT SETUP	Prints terminal setup report listing; Current application, Header, Trailer, Card and transaction types, Paper type, Surcharge, Security settings, PIN Pad info, HALOs, Modes, Tip settings and Hot Keys.
10.	STORE & FORWARD	Enables/disables offline settings: Upload transactions: Resend/delete failed transactions.
11.	CHECK READER	Enables/disables check imaging for upload to the Web.
12.	SIGNATURE OPTION *	Initializes an E-Pad allowing the capture of signatures for upload to the Web.
13.	BRIDGE COMM *	Allows communication between terminal and web.
14.	LANGUAGE SETUP *	Choose from the available languages for display or printer.
<b>4. HOST PARAMS</b>		
1.	HOST PARAMS	Edit parameter settings for all hosts.
2.	HOST PHONES	Edits authorization and batch phone numbers for all hosts.
3.	PRINT EDC SETUP	Prints EDC report listing; EDC types available, All EDC hosts, Capture types, Host parameters, Radio information (when applicable), AutoDial settings.
4.	PROTOCOL VER.	Displays host protocol name and version.
5.	AUTODIAL SETUP	Sets the terminal to automatically dial out for manual batching.
6.	HOST RADIO ADDR.	Displays programmed host radio address.

*Continued on next page.*

**QUICK REFERENCE GUIDE, Continued**

<b>5. SYSTEM OPTIONS</b>		
1.	SET TIME / DATE	Sets terminal's date (mm/dd/yy) and time (hh:mm:00): Clock is 24 Hour/Military time.
2.	EDIT PIN KEY	Edit host processor working key for debit processing.
3.	SEL. MSTR KEY	Change Master Key location.
4.	SET BATCH NO.	Change the current batch number.
5.	EDIT DATABASE	Void transaction: Clear database for selected or all EDC Types.
6.	WORKING MODE	Offers the ability to set: Tip options for retail and restaurant; AVS Option; Card Present Options and Comment Option.
7.	TEST MODE	Programming purposes only.
8.	PREDIAL CALL	Enables/disables terminal dialing immediately once card is swiped.
9.	PINPAD INIT.	Initialize external PIN Pad when necessary.
10.	PINPAD FUNC.	Allows encryption of working key in terminal
11.	PINPAD CONFIG.	Toggles between internal or external PIN Pad.
12.	STATUS BAR	Enables and Disables the Status Bar Display.
<b>6. RADIO TEST</b>		
1.	RADIO TESTS	Mobitex Units: Signal strength; MAN or ILL number; Radio Information
2.	PRINT PARAMS	Mobitex Units: Prints radio type; MAN/LLI number; Radio addresses.
3.	BATTERY TEST	Tests the battery.
<b>7. DOWNLOAD</b>		
1.	PARAMETERS	Downloads host and merchant parameters only.
2.	AUTOLOAD	Downloads full application and parameters.
3.	APPLICAT. ONLY	Downloads application only, no host or merchant parameters.
4.	COMM. PARAMS	Sets communication parameters for downloading.
<b>8. COMMUNICATIONS</b>		
1.	MIN. RETRIES	Number of times the terminal will call host processor before timeout.
2.	DIAL : TONE	Sets pulse or tone (DTMF) dialing.
3.	EXCHANGE PREF	Enables/disables and stores digit for dialing an exchange prefix before phone number.
4.	GATEWAY	Programming purposes only
5.	SUFFIX	Enables/disables and stores digit for dialing a suffix after phone number.
6.	VIA: LINE / RADIO	Not relevant for the NURIT 2085.
7.	CHK LINE: ON	Enables/disables the check line function.
8.	D. TONECHK: ON	Enables/disables the dial-tone check function.

**\* NOTE:** These features are available with POS\_PLUS application only.

## BASIC TROUBLESHOOTING

This section briefly describes how to troubleshoot some possible common problems that may rise during the normal operation of the NURIT 8000 Series. Before requesting service for this unit, check the list below for a possible cause of the problem you are experiencing. Some simple checks on your part may solve the problem, and restore proper operation. If you are still unable to solve the problem, contact the technical support help desk. Do **NOT** try to solve the problem by opening the terminal yourself!

---

### Terminal Seems to Have No Power

- Try pressing **<F>** and **<MENU>** keys simultaneously.
- Allow the battery to charge 10 to 12 hours with the terminal on and AC adapter plugged into the wall (in standby mode).

---

### “NO LINE” Appears on the Display

- Make sure that you are receiving radio coverage in the area where you are located.

---

### Printer Does Not Function Properly

- Check that the paper has been fed to the printer properly (underhand). The NURIT 8000 SECURE uses thermal paper **only**.
- Check there is paper in the printer compartment. Replace if required.
- If printer continues working even though the paper has been used up, check that the ‘end of paper’ detector in the printer mechanism is not blocked by a torn piece of paper.

---

### Card Reader Not Working

- Make sure that card has been swiped so that its magnetic strip is facing downward and facing to the front.
- Contact the technical support help desk.

---

### Receipt Prints “CANCELED”

- The terminal will display a host response, or some type of error message, as to why the transaction was canceled.

# Appendix B - Lipman USA Licensing Agreement

## 8000 Series POS EDC Terminals

### END-USER LICENSE AGREEMENT FOR LIPMAN USA SOFTWARE

**IMPORTANT-READ CAREFULLY:** This Lipman End-User License Agreement (“EULA”) is a legal agreement between you (either an individual or a single entity) and Lipman USA, Inc. (“Lipman”) for the Lipman Software Product identified above, which may include associated media, printed materials, and “online” or electronic documentation (“Software Product”). By installing, copying, or otherwise using the Software Product, you agree to be bound by the terms of this EULA. If you do not agree to the terms of this EULA, do not install, copy or use the Software Product and return the product to our attention at the address set forth below for a full refund.

### SOFTWARE PRODUCT LICENSE

The Software Product is protected by copyright laws and international copyright treaties, as well as other intellectual property laws and treaties. The Software Product is licensed, not sold.

**1. GRANT OF LICENSE.** This EULA grants you the following rights:

- **Software License.** Lipman grants you the non-exclusive right to make and use, solely in connection with your use of Lipman terminals, a number of copies of the Software Product equal to the number of Lipman [insert name of terminal] terminals validly purchased by you. You may also make copies of the Software Product for backup and archival purposes.
- **Distribution.** Lipman grants you a non-exclusive, royalty-free right to reproduce and distribute an unlimited number of copies of the Software Product, solely for use in connection with Lipman terminals, provided that you: (a) distribute the Software Product in object code form only as part of a software product created by you for use with Lipman terminals, that adds significant and primary value to the Software Product (the “Licensed Product”); provided such Licensed Product complies with all applicable laws, rules and regulations, including without limitation, all VISA, MasterCard and other association rules and regulations; (b) do not use Lipman’s name, logo, or trademarks to market the Licensed Product; (c) will not permit further distribution of the Software Product by your end-user customers; (d) include a valid copyright notice on the Licensed Product sufficient to protect Lipman’s copyright in the Software Product; (e) distribute and license the use of the Licensed Product to end users only pursuant to your end user license agreement; (f) indemnify, hold harmless, and defend Lipman from and against any claims or lawsuits, including attorney’s fees, that arise or result from the use or distribution of your Licensed Product; (g) otherwise comply with the terms of this EVLA; and (h) agree that Lipman reserves all rights not expressly granted. No license is granted to you in the source code of the Software Product.

**2. DESCRIPTION OF OTHER RIGHTS AND LIMITATIONS.**

Not for Redistribution Software. If the Software Product is labeled “Not for Redistribution” or “NFR,” then, notwithstanding other sections of this EULA, you may not resell, sublicense, or otherwise transfer for value, the Software Product by itself or as part of a Licensed Product.

*Continued on next page*

## Appendix B - Lipman USA Licensing Agreement, Continued

---

\* Maintenance of Copyright Notices. You must not remove or alter any copyright notices on all copies of the Software Product.

\* Limitations on Reverse Engineering, Decompilation, and Disassembly. Neither you nor your end-user customers may reverse engineer, decompile, disassemble or otherwise attempt to discover the source code of the Software Product, except and only to the extent that such activity is expressly permitted by applicable law notwithstanding this limitation.

\* Separation of Components. The Software Product is licensed as a single product. Its component parts may not be separated for use on more than one terminal.

\* Performance or Benchmark Testing. You may not disclose the results of any benchmark test of the Software Product to any third party without Lipman's prior written approval.

\* Support Services. Lipman may provide you with support services related to the Software Product ("Support Services"), use of Support Services is governed by the Lipman policies and programs described in the user manual, in "online" documentation, and/or in other Lipman-provided materials. Any supplemental software code provided to you as part of the Support Services shall be considered part of the Software Product and subject to the terms and conditions of this EULA. With respect to technical information you provide to Lipman as part of the Support Services, Lipman may use such information for its business purposes, including for product support and development. Lipman will not utilize such technical information in a form that personally identifies you.

Software Transfer. You may permanently transfer all of your rights under this EULA (i) only in conjunction with a permanent transfer of your validly purchased Lipman terminals; (ii) provided you retain no copies; (iii) you transfer all of the Software

Product (including all component parts, the media and printed materials, and any upgrades); and (iv) the recipient agrees to the terms of this EULA. If the Software Product is an upgrade, any transfer must include all prior versions of the Software Product.

\* Termination. Your rights under this EULA terminate upon the termination of your right to use the Lipman terminal being used in connection with the Software Product. Without prejudice to any other rights, Lipman may terminate this EULA if you fail to comply with the terms and conditions of this EULA. In such event, you must destroy all copies of the Software Product and all of its component parts.

### 3. UPGRADES

If the Software Product is labeled as an upgrade, you must be properly licensed to use a product identified by Lipman as being eligible for the upgrade in order to use the Software Product. A Software Product labeled as an upgrade replaces and/or supplements the product that formed the basis for your eligibility for the upgrade. You may use the resulting upgraded product only in accordance with the terms of this EULA. If the Software Product is an upgrade of a component of a package of software programs that you

licensed as a single product, the Software Product may be used and transferred only as part of that single product package and may not be separated for use on more than one terminal.

---

*Continued on next page*

## Lipman USA Licensing Agreement, Continued

---

### 4. COPYRIGHT

All title, including but not limited to copyrights, in and to the Software Product and any copies thereof are owned by Lipman or its suppliers. All title and intellectual property rights in and to the content which may be accessed through use of the Software Product is the property of the respective content owner and may be protected by applicable copyright or other intellectual property laws and treaties. This EULA grants you no rights to use such content.

### 5. U.S. GOVERNMENT RESTRICTED RIGHTS

The Software Product is provided with RESTRICTED RIGHTS. Use, duplication, or disclosure by the Government is subject to restrictions as set forth in subparagraph (c)(1)(ii) of the Rights in Technical Data and Computer Software Clause at DFARS 252.227-7013 or subparagraphs (c)(1) and (ii) of the Commercial Computer Software Restricted Rights at 48 CFR 52.227-19, as applicable. Manufacturer is Lipman USA, Inc., 50 Gordan Drive, Syosset, New York 11791.

### 6. EXPORT RESTRICTIONS

You agree that you will not export or re-export the Software Product to any country, person, entity or end user subject to U.S.A. export restrictions. Restricted countries currently include, but are not necessarily limited to Cuba, Iran, Iraq, Libya, North Korea, Sudan, and Syria. You warrant and represent that neither the U.S.A. Bureau of Export Administration nor any other federal agency has suspended, revoked or denied your export privileges.

### 7. NO WARRANTIES.

Lipman expressly disclaims any warranty for the Software Product. THE SOFTWARE PRODUCT IS PROVIDED "AS IS" WITHOUT WARRANTY OR CONDITION OF ANY KIND, EITHER EXPRESS OR IMPLIED, INCLUDING, WITHOUT LIMITATION, THE IMPLIED WARRANTIES OF MERCHANTABILITY, FITNESS FOR A PARTICULAR PURPOSE, OR NON-INFRINGEMENT. THE ENTIRE RISK ARISING OUT OF USE OR PERFORMANCE OF THE SOFTWARE PRODUCT REMAINS WITH YOU.

### 8. LIMITATION OF LIABILITY

In no event shall Lipman or its suppliers be liable for any damages whatsoever (including, without limitation, damages for loss of business profits, consequential or incidental damages, business interruption, loss of business information, or any other pecuniary loss or expense) arising out of the use of or inability to use the Software Product, even if Lipman has been advised of the possibility of such damages. Because some states and jurisdictions do not allow the exclusion or limitation of liability for consequential or incidental damages, the above limitation may not apply to you.

### MISCELLANEOUS

This EULA is governed by the laws of the State of New York, excluding the application of its conflict of laws rules. In the event of any dispute arising from or relating to this EULA, the parties hereto irrevocably consent to the personal jurisdiction of the courts located in New York, New York, which shall be the exclusive venue for any such dispute. The United Nations' Convention on International Sale of Goods does not apply. This EULA sets forth the entire understanding and agreement between you and Lipman and may be amended only in a writing signed by both parties.