



Digital to Analog TV Converter Box with Analog Pass Through

Model # ATVC102

User's Manual

Ver. 1B

TABLE OF CONTENTS

1. IMPORTANT INFORMATION	3
LABORATORIES	4
2. ACCESSORIES	5
3. FRONT PANEL	5
4. REAR PANEL	6
5. REMOTE CONTROL	6
5-1. BUTTON DESCRIPTIONS	6
6. SETUP	7
6-1. REMOTE CONTROL	7
6-2. BASIC CONNECTION	8
6-3. START UP	9
6-4. INSTALLATION GUIDE	9
7. BASIC OPERATION (NON MENU MODE)	11
8. MENUS	14
8-1. MENU>CHANNEL>FAVORITE LIST EDITOR:	14
8-2. MENU>SCAN>AUTO SCAN.....	14
8-3. MENU>SCAN>MANUAL SCAN	15
8-4. MENU>SETUP>SCREEN SETTING	16
8-5. MENU>SETUP>SYSTEM SETTING	16
8-6. MENU>SETUP>PARENTAL CONTROL (V-CHIP).....	17
8-7. MENU>SETUP>CLOSED CAPTION	21
8-8. MENU>SETUP>TIME ZONE.....	21
8-9. MENU>SETUP>FACTORY DEFAULT	22
8-10 MENU>SETUP>INFO>SYSTEM INFORMATION	22
9. SPECIFICATIONS	23
TECHNICAL SUPPORT	24

Introduction

Congratulations on your purchase of Airlink101® Digital to Analog TV Converter Box with Analog Pass-Through, ATVC102. At midnight on February 17, 2009, all full-power television stations in the United States will stop broadcasting in analog and switch to 100% digital broadcasting, while low-power TV stations does not have to next year. (For more details, please go to www.dtv2009.gov.) To continue enjoying both analog and digital channels with greater video/audio quality on your current analog TV, Airlink101® ATVC102 is your best solution. This product connects to your analog TV and allows it to receive and display over-the-air digital and analog broadcasts to your TV set. Other great features of this product include:

- Receiving channels from both analog and digital TV stations
- Searching for broadcast channels 2 through 69 automatically
- Providing Electronic Program Guide (EPG) function with up to 7-day on-screen listing of TV programs information
- Supporting V-Chip, Parental Control feature to manage children's television viewing by rating categories
- Working with your existing VHF/UHF or HDTV antenna to deliver better picture and sound quality
- Createing favorite channel lists which can be accessed using one-touch remote control
- Supporting 4:3, 16:9 and zoomed output
- EnergyStar compliant for energy saving

Instructions for installing and configuring this product can be found in this manual. Before you install and use this product, please read this manual carefully for proper operation of this product.

1. IMPORTANT INFORMATION

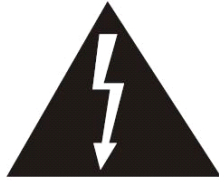

CAUTION
RISK OF ELECTRIC SHOCK
DO NOT OPEN



WARNING: HIGH VOLTAGE INSIDE. TO PREVENT ELECTRICAL SHOCK, DO NOT REMOVE ANY COVER OR SCREWS. REFER ALL SERVICING TO QUALIFIED SERVICE PERSONNEL. DO NOT ALLOW THIS PRODUCT TO BE EXPOSED TO RAIN OR MOISTURE. DISCONNECT THE MAIN PLUG FROM THE SUPPLY SOCKET WHEN NOT IN USE.

WARNING: Do not use this product where contact with or immersion in water is a possibility. Do not use near flower vase, washbowls, kitchen sinks, laundry tubs, swimming pools, etc.

WARNING: Do not put a candle or lamp stand on the cabinet as this creates a fire hazard.

WARNING: The unit should be connected to a power supply other than the type described in the operating instructions or as marked on the unit. If you are not sure of the type of power supply (for example, 120 or 230 V) to your home, consult your local dealer or local power company.

WARNING: Diodes are used in this product. To avoid direct exposure to radiation, do not open the cabinet or touch any parts in the inner mechanism. Consult your local dealer for technical service if opening is required.

Note: To ensure proper use of this product, please read this User Manual carefully and retain for further reference.

Unit Cleaning: After the unit power is turned off, you can clean the cabinet, panel and remote control with a soft cloth lightly moistened with a mild detergent solution.

Attachments: Never add any attachments and/or equipment without the manufacturer's consent as such additions may result in the risk of fire, electric shock, or other personal injury.

Locating: Slots and openings in the cabinet are provided for ventilation to protect it from overheating. Do not block these openings or allow them to be blocked by placing the unit on a bed, sofa, or other similar surface, nor should it be placed over a radiator or heat register.

Power-Cord Protection: Place the power-supply cord out of the way, where it will not be walked on. Please pay special attention to cords and plugs at the points where they make their connections.

Object and Liquid Entry: Never put objects of any kind into this unit through openings, as they may touch dangerous voltage points or short-out parts that could result in a fire or electric shock. Never pour or spill any liquid on the unit.

Note: Moisture may be formed on the power indicator lens under the following conditions:

- ⌚ when the unit is suddenly moved from a cold environment or an air-condition room to a warm place.
- ⌚ immediately after a heater has been turned on.
- ⌚ in a steamy or very humid room.

If moisture forms inside the unit, it may not operate properly. To correct this problem, turn on the power and wait for about two hours for the moisture to evaporate.

Parts Replacement: If any component parts in the unit need to be replaced, the user should make sure the service technician uses replacement parts specified by the manufacturer or having the same characteristics as the original part. Unauthorized replacement may put the unit under the risk of fire, electric shock or other hazards.

Safety Check: After all maintenances and repairs are done, the user should request that the service technician conduct an overall safety check to ensure the unit is safe to operate under normal conditions.

The power supply for this device is UL Approved.

This device meets the ENERGY STAR guidelines for energy efficiency. ENERGY STAR is a U.S. registered mark.



Manufactured under license from Dolby laboratories.



2. ACCESSORIES

- Remote Control with 2 AAA Batteries
- Power Adapter: AC Input 110V~120V, DC Output 12V/1A
- 1x RF/Coaxial Cable
- 1x Mini-to-RCA Cable
- User's Manual

3. FRONT PANEL

1. Power Indicator

Green light: ON

Red light: STANDBY

2. Power button

Press → ON

Press → OFF



4. REAR PANEL

1. ANT IN - Antenna RF input
2. RF OUT – RF/Coaxial cable connection to the TV
3. CH3/CH4 Switch - Switch RF OUT channel
4. AV - Audio/Video (RCA)
5. DC 12V 1A - Power adapter

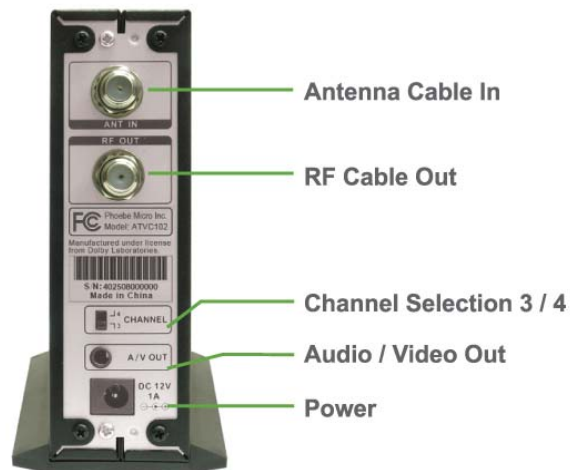





5. REMOTE CONTROL

5-1. Button Descriptions

1. **MUTE:** Mute or restore the sound
2. **CC:** Close Caption on/off
3. **AUDIO:** Toggle preferred audio language
4. **EPG:** Electronic Program Guide
Displays a program guide if pressed when not in "Menu" mode
5. **OK:** Activates the highlighted MENU item
Activates the Quick Channel list if pressed when not in "Menu" mode
6. **◀/▶ Left/Right:** Increase/decrease the volume level if pressed when not in "Menu" mode
Moves the cursor to the left/right if pressed in "Menu" mode
7. **FUNC:** Used for special Functions in Menu mode based on color code
8. **Exit:** Exits from the menu or sub-menu and Cancels any functions in progress
9. **NUMERIC KEY (0-9):** Controls numerical operations and used to change channels



directly

10. : Used to enter a dash “-“ in the channel number
11.  POWER on/off: Turns the receiver ON/OFF
12. ZOOM: Switches the screen format (Full/Letter/Center)
13. SIGNAL: Activates the signal meter
14. FAV: Shows the current list of favorite channels
Press multiple times to scroll through lists
15.  UP/Down: Changes the current channel to the previous/next channel when not in “Menu” mode. Moves the cursor up/down in Menu mode
16. MENU: Shows the Menu or sub-menu and cancels any other function in progress
17.  Info: Activates the Info banner
18.  Recall: Returns to the last channel

6. SETUP

6-1. Remote Control

Open the Battery Cover and insert batteries into the controller.

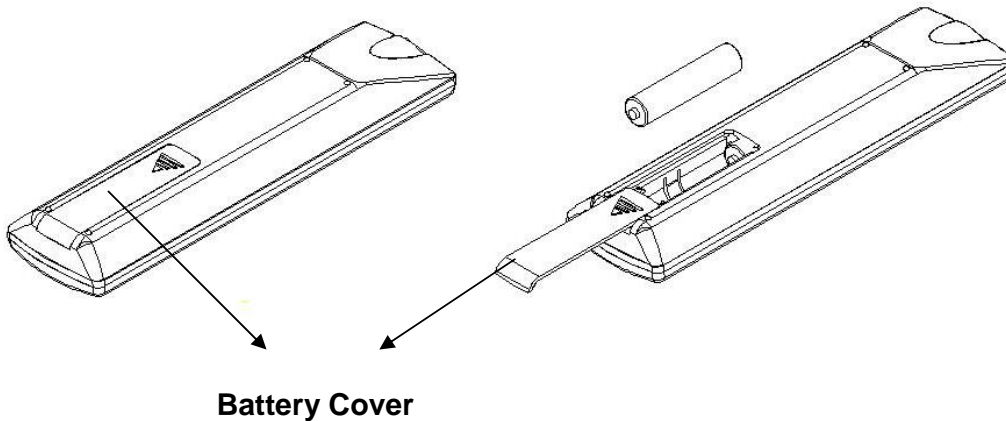

Note: Be sure to insert batteries according to the polarity +/- marks inside the remote control.

6-2. Basic Connection

Please perform the following steps to connect your device.

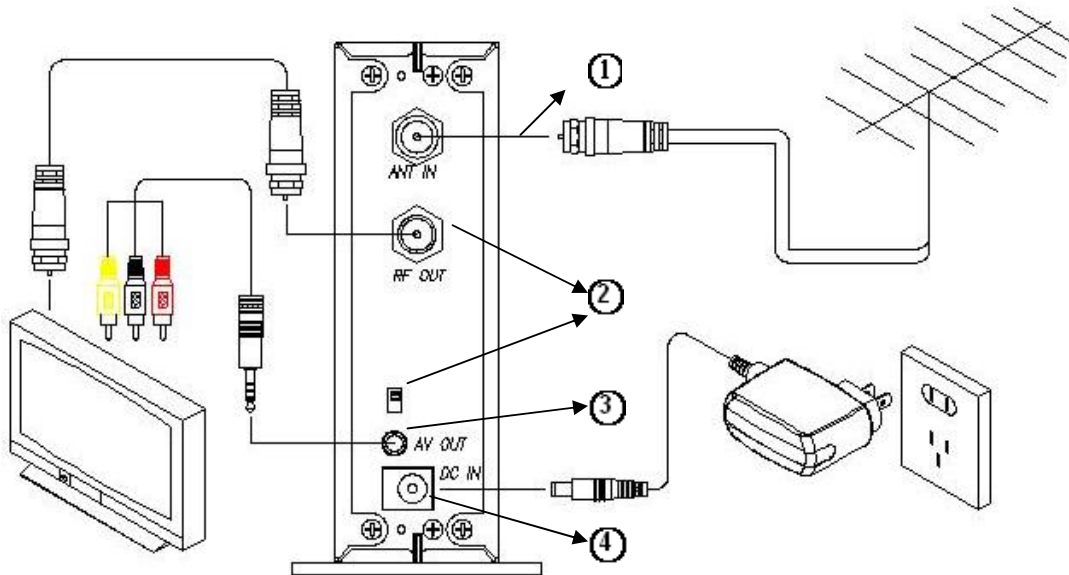

1. Outdoor Antenna Connection

Connect a cable from your antenna (outdoor or rabbit-ears) to the F-Type “ANT IN” connector.

2. Make a connection to the TV using [either step 2.1 or step 2.2](#)

2.1 RF AV Cable Connection

Use the supplied RF cable to plug into the “RF OUT” terminal on the device. Plug the other end of the cable into the TV set. Be sure to set the **CH3/CH4** SWITCH on the device to match the same channel you select on the TV set. If you set the CH3/CH4 switch on the device to CH3, please switch TV set to channel 3. If you set the switch to CH4, please switch the channel on your TV set to CH4.

2.2 AV Cable Connection (not required if you use the RF Cable in 2.1)

Plug the black end of the supplied AV cable into the device “AV OUT” connector, and plug the other ends of the cable into your TV, **YELLOW** terminal for VIDEO IN, **RED** terminal to AUDIO IN(RIGHT), **WHITE** terminal to AUDIO IN(LEFT). Then switch your TV set to Video input.

3. Power Adapter Connection

Plug the power adapter into a wall outlet. Connect the other end to the “DC IN” Jack on the device.

4. Analog Pass Through

Analog pass-through is enabled when you connect your TV following Section 6-2 (RF Cable). This device will pass through analog TV signals from “ANT IN” to “RF OUT.”

To use the analog pass through feature:

- 4.1 Install the unit as described in Section 6-2, 2.1 using the RF cable.
- 4.2 Use the Menu to turn the “Loop Through” option to ON as described in section 8-5.5 of this manual.
- 4.3 Turn off the power by pressing the power button on the device.
The device is in “Stand-by” mode when the red light is on.

6-3. Start up

Ensure that your device is properly connected to your television as described in 6.2 above, that you have inserted the batteries into the remote and that the signal quality is good. Press the power button on the device or remote control to activate the device.



Power Button

6-4. Installation Guide

When the device is first used, the Installation Guide will be displayed. Follow the Installation Guide to set the parameters and perform channel scanning as described below:

1. Select your Language.

The default language for the On Screen Menu (OSM) is set to English. Press Left/Right to choose another display language: English, Spanish, French.

Press OK to go the next page or



press EXIT to go to the previous page.

2. Select the Time Zone.

Press the Left/Right button to select your time zone. The unit will automatically display the correct time for your selected time zone.



3. Set the Auto Daylight Saving.

The default setting of the Auto Daylight is "YES." Press the Left/Right button to enable/disable the Auto - Daylight saving feature.

Press OK to go to the next page.

4. Select the first Audio Language.

The default setting for the Audio Language is English. Press the Left/Right button to change Audio Language: English, Spanish, French.



Press OK to go to the next page.

5. Set the Screen Format.

The default setting for the Screen Format is Full mode. Press Left/Right to change the Screen Format:

Full, Letter, Center.

Press OK to go to the next page.



6. Channel Scan.

Channel scanning will take several minutes. Please wait until the "Finish" dialog box shows. Press OK to watch the programs.

Scanned channels



Finish Dialog



7. Basic Operation (non Menu mode)

While viewing TV or Radio channels, various functions can be performed using your remote control. Following is an explanation of the buttons on your Remote Control and the corresponding functions:

A. Power:

Turns the receiver ON/OFF.

B. Mute:

Mutes audio output of the receiver.

C. Numeric key(0-9):

Change the channel directly by pressing the channel number.

D. RECALL:

Recall the last channel.

E. Δ/∇ UP/Down:

Press Δ/∇ to change the channel.

F. $\triangleleft/\triangleright$ Left/Right:

Press $\triangleleft/\triangleright$ to decrease /increase the Volume.

G. OK:

Press OK to activate the Quick Channel List.

Press the Red key to go to the previous page.

Press the Green key to go to the next page.

Press the UP/Down key to move the cursor.

Press OK to view the selected channel.

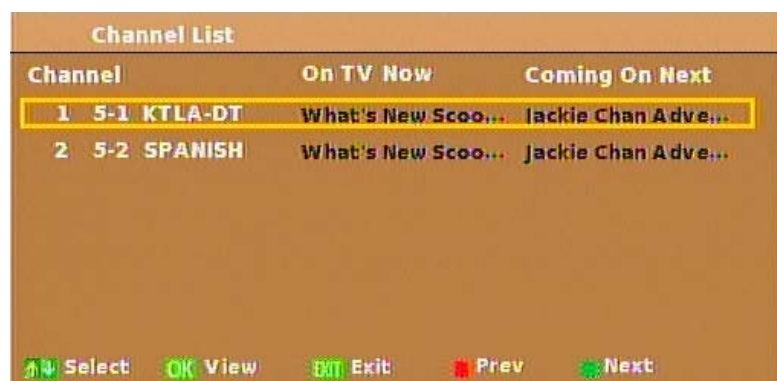

Channel	On TV Now	Coming On Next
1 5-1 KTLA-DT	What's New Scoo...	Jackie Chan Adve...
2 5-2 SPANISH	What's New Scoo...	Jackie Chan Adve...

Select View Exit Prev Next

H. INFO:

Press INFO to activate the Info Bar and Rating Info.

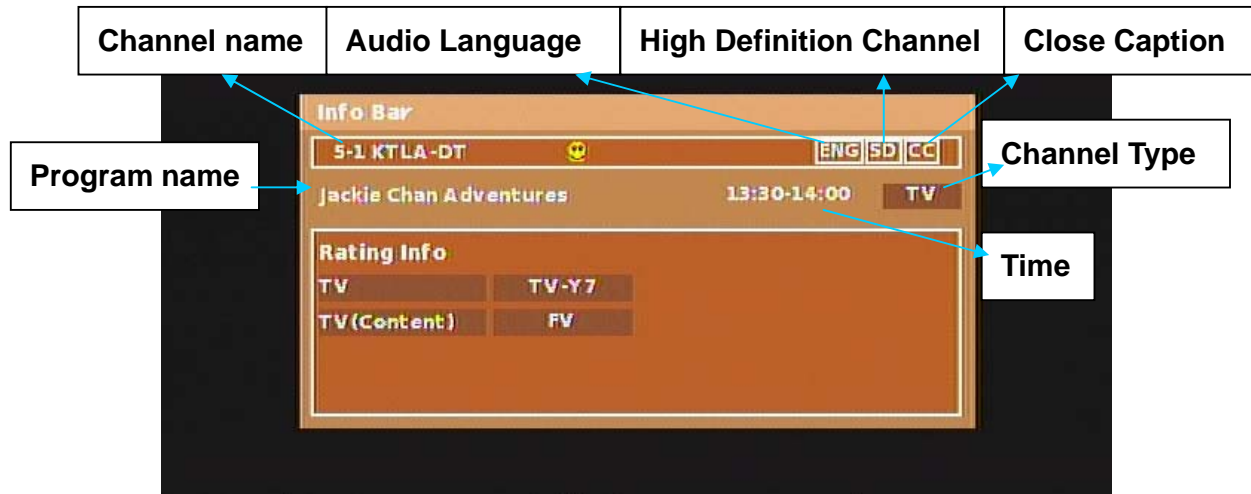

I. Signal:

Press Signal to activate the Signal Bar.

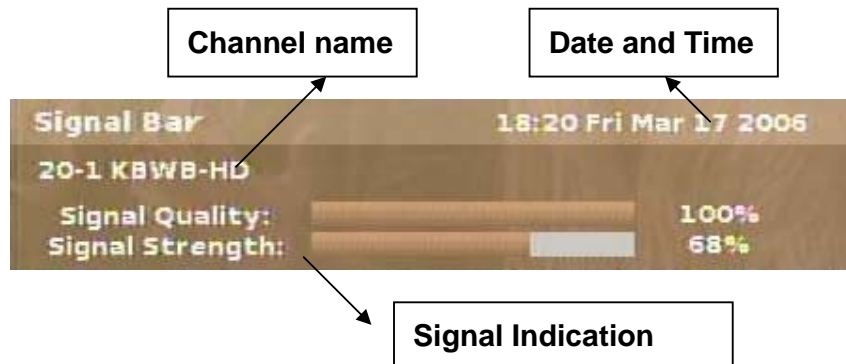

J. Audio:

Press Audio to change the Audio language.

K. Zoom:

Change the screen format.

L. FAV:

Press FAV to activate the favorite Channel list.

To setup favorite channel list, please go to 8.1, Menu > Channel > Favorite List Editor.

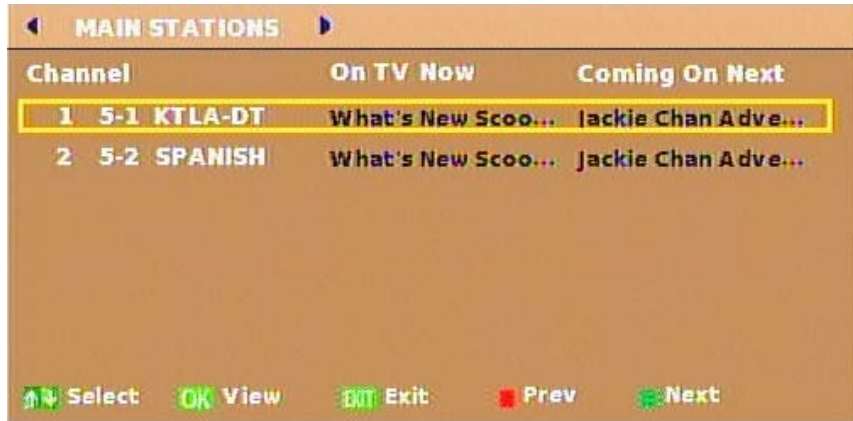

There are 16 favorite groups:

Movie, Animal, Education, Politics, Music, Educational, Religious, Adult, Kids, Cartoon, Wildlife, Technology, Business, International, News, Entertainment, Sports, etc...

Press the Red key to return to the previous page.

Press the Green key to go to the next page.

Press Δ/∇ to move the cursor.

Press OK to view the selected channel.

Press $\triangleleft/\triangleright$ to change the favorite group.

M. CC:

Press CC to toggle the Closed Caption service:

OFF \rightarrow Service1 \rightarrow Service2 \rightarrow Service3 \rightarrow Service4 \rightarrow Service5 \rightarrow Service6 \rightarrow CC1 \rightarrow CC2 \rightarrow CC3 \rightarrow CC4 \rightarrow TT1 \rightarrow TT2 \rightarrow TT3 \rightarrow TT4 \rightarrow OFF

Note: Each Channel may have different Closed Caption service, you can check out the INFO of each TV channel, to discover which Closed Caption it has, then press CC to go to the right caption service.

N. EPG (Electronic Program Guide):

Press EPG to activate the EPG menu.

In this menu, you can see the program guide for every channel.



8. Menus

Press the Menu button on the remote control to display the On Screen Menu (OSM) on your TV screen.

8-1. Menu>Channel>Favorite List Editor:

In this menu, you can edit the favorite group. You can also see the current channel list.

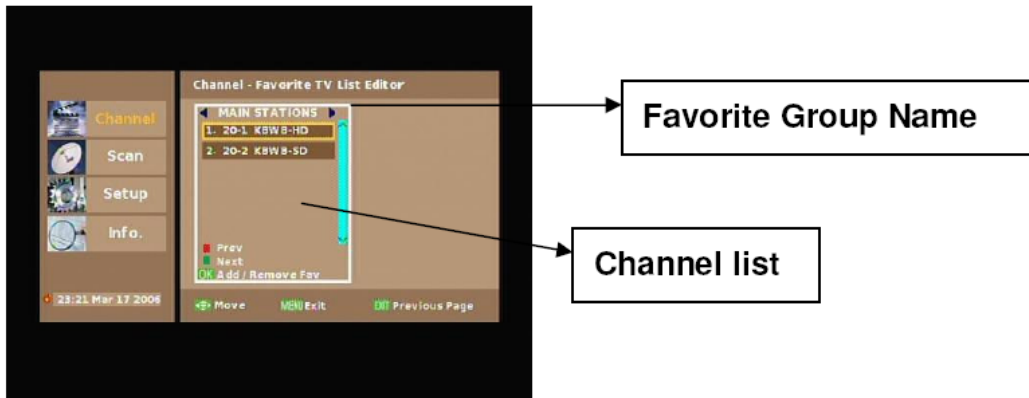

Press the key to switch favorite groups.

Press the key to change the channel.

Press the Red key to return to the previous page.

Press the Green key to go to next page.

Press the OK key to add a channel in the shown favorite group.

8-2. Menu>Scan>Auto Scan

In this menu, you can scan available channels.



Press OK to start and stop the Auto Scan at any time.

8-3. Menu>Scan>Manual Scan

From this menu, you can scan for channels one at a time without removing the previously auto scanned channels. If during the auto scan, some of the channels that you like to watch were not found, you can attempt to find additional channels by changing the position of your antenna and performing a “Manual Scan” for individual channels.

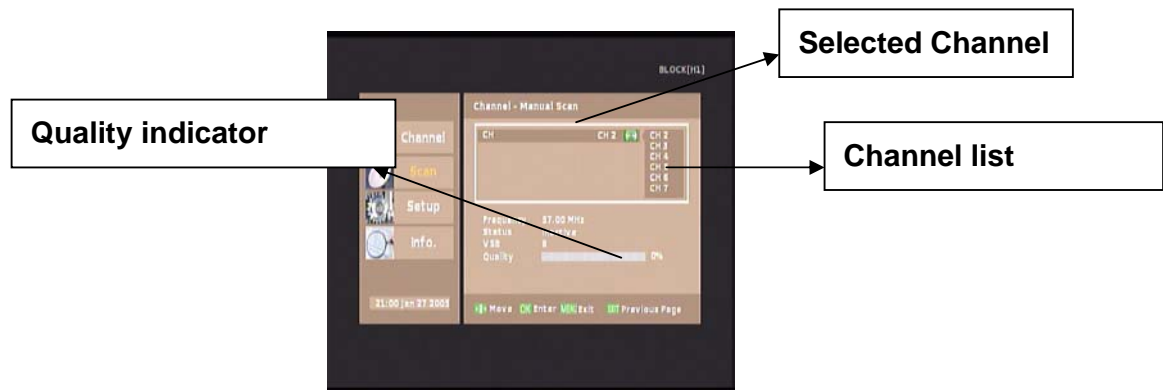

Note: You can tell which channels were found during Auto Scan by checking to see if there is a number next to “Programs” under the quality indicator.

Note: TV stations will have a new digital channel numbers that is different from their old analog channel number that you were used to watching. Instead of finding your old favorite channel by scanning the old analog channel number, you will need to scan using the new digital channel number or frequency. To simplify the transition, most TV Stations are being allowed to use the same old analog channel number (virtual channel number) followed by a -1 (dash 1). However, you must first scan the new digital channel number before using the virtual number. Contact your local TV station to find their digital channel number or frequency

Press OK to start the Manual Scan.

Press </> to select specific frequency channel.

You can adjust the position of the antenna during the scan in order to find the optimal antenna position for the selected channel/frequency.

‘No Signal’ will be displayed if the signal is too weak; otherwise, the newly scanned channel will be added to the channel list.

8-4. Menu>Setup>Screen Setting

In this menu, you can select the screen format: FULL, Letter, Center.



Screen Format
List

White Line is TV.
Gray rectangle is
the content.

Press the $\triangleleft/\triangleright$ key to switch Screen Formats.
Press OK to confirm the selection.

8-5. Menu>Setup>System Setting

In this menu, you can change the OSD (On-Screen Display) Language, OSD Opacity, Audio Language, Auto Sleep, etc...

1. OSD Language:

Press the $\triangleleft/\triangleright$ key to select either:
English, Spanish, or French.

2. Audio Language:

Press the $\triangleleft/\triangleright$ key to select either:
English, Spanish, or French.

3. Sound Output:

Select one of 4 settings: Normal, Left,
Right, Mixed.

4. Auto Sleep:

There are several settings: OFF, 15 Minutes, 30 Minutes, 1 Hour, 2 Hours,
and 4 Hours.

Press the $\triangleleft/\triangleright$ keys to switch between the settings.

Press the \triangle/\triangledown keys to move focus to a different function.



5. Loop Through (Analog Pass-Through):

To comply with EnergyStar, the default setting is off. Press the $\triangleleft/\triangleright$ keys to switch between off and on. Enable the loop through option to pass analog signals through your converter box when the power to the converter box is off.

8-6. Menu>Setup>Parental Control (V-Chip)

From this menu, you can select: Lock System, Country, Rating Control, and Change Password.

1. Lock System:

You can set ON/OFF to enable / disable the Parental Control lock system.

2. County:

You can set the country of the rating (USA/Canada).

3. Rating Control: (V-Chip)

You can set the Rating Controls. The TV Rating/MPAA Rating is for USA. The English Rating/ French Rating is for Canada.

Press the Δ/∇ keys to move focus.
Press OK to confirm the selection.



3.1 TV Rating

The television industry has adopted voluntary ratings for TV programs.

Select "Allow All" to allow all the TV ratings.

Select Block All to block all the TV ratings.

To control or change blocking for any specific setting, Press the Δ/∇ $\triangleleft/\triangleright$ keys to move to any box and Press OK to confirm the selection.



3.2 MPAA Rating

MPAA Ratings are for motion pictures.

Press the Δ/∇ $\triangleleft/\triangleright$ keys to move focus.

Press OK to confirm the selection.



TV Parental Guidelines		
Age Based	TV-Y	All children
	TV-Y7	Direct to older children
	TV-G	GENERAL AUDIENCE
	TV-PG	PARENTAL GUIDANCE SUGGESTED
	TV-14	PARENTS STRONGLY CAUTIONED
	TV-MA	MATURE AUDIENCE ONLY
Content Based	FV	FANTASY VIOLENCE SCENE
	V	VIOLENCE SCENE
	S	SEXUAL SITUATION
	L	ADULT LANGUAGE
	D	SEXUALLY SUGGESTIVE DIALOG
MPAA RATING		
G	General audiences	All ages admitted
PG	Parental guidance suggested	Some material may not be suitable for children
PG-13	PARENTS STRONGLY CAUTIONED	SOME MATERIAL MAY NOT BE SUITABLE FOR CHILDREN UNDER 13
R	RESTRICTED	UNDER 17 REQUIRES ACCOMPANYING PARENT OR ADULT GUARDIAN
NC-17		NO ONE 17 AND UNDER ADMITTED
X		UNIFIED WITH NC-17
NR	NOT RATED	

3.3 English Rating

The rating system used by English-language programming services has six levels.

Press Δ/∇ $\triangleleft/\triangleright$ to move focus.
Press OK to confirm the selection.



3.4 French Rating

The rating system used by French-language programming services has six levels.

Press Δ/∇ $\triangleleft/\triangleright$ to move focus.
Press OK to confirm the selection.



English Rating		
E	Exempt	Exempt programming
C	Children	For younger children under the age of 8 years
C8+	CHILDREN EIGHT YEARS AND OLDER	FOR YOUNGSTERS 8 YEARS AND OVER.
G	GENERAL PROGRAMMING, SUITABLE FOR ALL AUDIENCES	APPROPRIATE VIEWING FOR THE ENTIRE FAMILY.
PG	PARENTAL GUIDANCE	NOT SUITABLE FOR VIEWERS UNDER THE AGE OF 8
14+	VIEWERS 14 YEARS AND OLDER	NOT SUITABLE FOR VIEWERS UNDER THE AGE OF 14
18+	ADULT PROGRAMMING	INTENDED FOR VIEWERS 18 YEARS AND OLDER.

French Rating		
E	Exempt	Exempt programming
G	General	Appropriate viewing for the entire family.
8+	CHILDREN EIGHT YEARS AND OLDER	FOR YOUNGSTERS 8 YEARS AND OVER.
13+	GENERAL PROGRAMMING, SUITABLE FOR ALL AUDIENCES	FOR YOUNGSTERS 13 YEARS AND OVER.
16+	PARENTAL GUIDANCE	FOR YOUNGSTERS 16 YEARS AND OVER.
18+	ADULT PROGRAMMING	INTENDED FOR VIEWERS 18 YEARS AND OLDER.

3.5 Digital Rating

Press Δ/∇ to move focus.

Press \leftarrow/\rightarrow to switch selection.

Press OK to confirm the selection.



4. Change Password:

The default password is set to “1234.”

You can change the password from “1234” to your preference.

8-7. Menu>Setup>Closed Caption

From this menu, you can select the Caption Type, and customize features such as the Caption size, Foreground Color, Foreground Opacity, Background Color and Background Opacity.

1. Caption Type:

The caption services include:
OFF, Service1-6, CC1-4, TT1-4.

2. Customization:

Press ◀/▶ to select ON/OFF.

3. Caption Size:

You can select from three sizes: Small, Standard, Large.

4. Foreground Color:

You can select from eight colors: Black, White, Red, Green, Blue, Yellow, Magenta, Cyan.

5. Foreground Opacity:

You can select from five opacity settings: Full, High, Half, Low, Zero.

6. Background Color:

You can select from eight colors: Black, White, Red, Green, Blue, Yellow, Magenta, Cyan.

7. Background Opacity:

You can select from five settings: Full, High, Half, Low, Zero.



8-8. Menu>Setup>Time Zone

In this menu, you can set the Time Zone, and Auto Daylight Savings feature.

1. Time Zone:

You can select from six time zones:
Hawaii, Alaska, Pacific, Mountain, Central, or Eastern.

2. Auto Daylight Saving:

Enable/disable the Auto Daylight Savings feature.



8-9. Menu>Setup>Factory Default

You can load the default factory settings from this menu.



8-10 Menu>Setup>Info>System Information

This menu displays the product name, software version, hardware version, and loader version.



9. Specifications

1 Tuner and Channel

Input Connector:	F-type, IEC169-24, Female
Frequency:	54 MHz ~ 806 MHz
Input Impedance:	75ohm unbalanced
Signal Level:	-5 to -83 dBm
Demodulation:	8VSB

2 System & Memory

Main Processor:	RTK 2881S
Flash Memory:	2 Mbytes
DDR:	32 Mbytes
Channel Memory:	500
Multi Language Menu:	English, Spanish, French
Front Panel:	1 key
Led indicator:	1 (Power Led)
Remote Control:	32 keys, IR remote Control

3 MPEG Transport Stream & A/V Decoding

Transport Stream:	MPEG2 ISO/IEC 13818
Profile Level :	MPEG2 MP@ML
Aspect Ratio:	4:3, 16:9
Frame Rate:	30Hz for NTSC
Video Input Resolution:	1080i, 720P, 480i, 480P
Video Output Resolution:	480i
Closed Caption:	Through VBI
Audio Decoding:	MPEG 1/2, AC3
Audio Mode:	Stereo

4 AV Input

AV Input:	CVBS, L, R Output with Volume Control
------------------	--

5 RF-Modulator

Output Channel:	CH3/CH4
TV Standard:	NTSC
Audio Output	Mono with Volume Control

6 Physical Specifications

Size:	182 x 118 x 36 mm (L x W x H)
--------------	--------------------------------------

Technical Support

E-mail: support@airlink101.com

Toll Free: 1-888-746-3238

Web Site: www.airlink101.com

* Picture quality, reception and channel numbers depend on the television set, type of antenna, weather and distance from station transmitter. Specifications are subject to change without notice. Copyright © 2008 AirLink101®. All rights reserved. AirLink101®, the stylized AirLink101 logo, specific product designations, and all other words and logos that are identified as trademarks and/or service marks are, unless noted otherwise, the trademarks and service marks of AirLink101®. All other product or service names are the property of their respective holders. AirLink101® products are protected under numerous U.S. and foreign patents and pending applications, mask work rights, and copyrights.