

LUFTIG[®] AU

BF325



Design and Quality
IKEA of Sweden

Contents

Safety information	4	What to do if ...	9
Product description	7	Technical data	10
Control panel	7	Environmental concerns	11
Cleaning and maintenance	7	IKEA GUARANTEE	12

Safety Information

Before first use

Your safety and that of others is paramount.

Remove cardboard protection pieces, protective film and adhesive labels from accessories.

Check the appliance for any transport damage.

To avoid any damage do not place any weights on the appliance. Do not expose the appliance to atmospheric agents.

This manual and the appliance itself provide important safety warnings, to be read and observed at all times.

 This is the attention symbol, pertaining to safety, which alerts users to potential risks to themselves and others.

All safety warnings are preceded by the attention symbol and the following terms:

 **DANGER:** indicates a hazardous situation which, if not avoided, will cause serious injury.

 **WARNING:** Indicates a hazardous situation which, if not avoided, could cause serious injury.

All safety warnings give specific details of the potential danger/warning present and indicate how to reduce risk of injury, damage and electric shock resulting from improper use of the appliance. Carefully observe the following instructions.

Precautions and general recommendations

- The electrical installation and the electrical connection must be carried out by a qualified technician according to the manufacturer's instructions and in compliance with the local safety

regulations. Do not repair or replace any part of the appliance unless specifically stated in the user manual.

- The appliance must be disconnected from the power supply before carrying out any installation work.
- Earthing of the appliance is compulsory. (required only for class I).
- The power cable must be long enough for connecting the appliance, once fitted in its housing, to the power supply socket.
- Do not pull the power supply cable in order to unplug the appliance.
- The electrical components must not be accessible to the user after installation.
- Do not touch the appliance with any wet part of the body and do not operate it when barefoot.
- The appliance is not intended for use by persons (including children) with any physical, sensory or mental impairment, or without experience and knowledge of the appliance, unless supervised or previously instructed in its use by those responsible for their safety.
- Do not repair or replace any part of the appliance unless specifically indicated in the manual. All other maintenance services must be carried out by a specialised technician.
- Children must be supervised to ensure they do not play with the appliance.
- When drilling through the wall pay attention not to damage electric connections and/or pipes.
- Air vents must always discharge to the outside.

- The manufacturer rejects all responsibilities for any damage caused by improper use or wrong settings.
- Appropriate maintenance and cleaning ensure the good working order and the best performance of the appliance. Regularly clean all stubborn surface dirt to avoid grease build up. Remove and clean or change the filter regularly.
- Never flame cook food (flambé) under the appliance. Using free flames might cause fire.
- Failure to observe the instructions for cleaning the hood and replacing the filters may result in a fire.
- Exhaust air must not be vented through a flue used for removal of fumes produced by gas combustion appliances or other combustible materials, but must have a separate outlet. All national regulations governing extraction of fumes must be observed.
- There shall be adequate ventilation if the hood is being used at the same time as other appliances using gas or other combustible materials. The negative pressure of the room must not exceed 4 Pa (4x 10⁻⁵ bars). For this reason ensure that the room is well ventilated.
- Do not leave frying pans unattended when frying, as the frying oil may catch fire.
- Before touching the light bulbs, ensure that they are cold.
- Do not use or leave the hood without the light bulb correctly fitted, as this may cause electric shock.
- The hood is not a work surface, therefore do not place any objects on top of it or overload it.
- During all installation and maintenance operations wear appropriate working gloves.
- This appliance is not suitable for outdoor use.

CAUTION: Accessible parts may become hot when used with cooking appliances.

Installation and connection

After unpacking the appliance, check for any transport damage. In the event of problems, contact the After-sales Service. To prevent any damage, only remove the appliance from its polystyrene foam packaging at the time of installation.

Preparing for installation

 **WARNING:** this is a heavy product; the hood should only be lifted and installed by two or more people.

The minimum distance between the hob and the bottom part of the hood must not be less than 65 cm for gas cookers and 50cm for electric cookers.

Before installation also check the minimum distances stated in the manual of the cooker. If the installation instructions for the cooker specify a greater distance between cooker and hood, this distance must be observed.

Electrical connection

Make sure the power voltage specified on the appliance rating plate is the same as the mains voltage.

This information can be found on the inside of the hood, under the grease filter. Power cable replacement (type H05 VV-F) must be carried out by a qualified electrician. Contact an authorized service centre.

If the hood is fitted with an electric plug, connect the plug to a socket complying with current regulations, located in an accessible place.

If no plug is fitted (direct wiring to the mains), or if the socket is not located in an accessible place, a qualified electrician should install a standardised double pole power switch that will enable complete isolation from the mains in case of category III overvoltage conditions, in accordance with wiring rules.

Use

The hood has been designed to be installed and used either as a “Exhausted model”, or as a “Recirculation model”.

Exhausted model (see symbol  in installation booklet)

Cooking steam is sucked and channelled outside the house through a discharge duct (not supplied), fitted to the hood steam outlet.

Ensure that the discharge duct is correctly fitted to the air outlet, unit using an appropriate connection system.

Important: If already installed, remove the charcoal filter/s.

Recirculation model (see symbol  in installation booklet)

The air is filtered through one or more the charcoal filters, and then resent into room.

Important: Ensure appropriate air circulation around the hood.

Important: If the hood is supplied without charcoal filters, these must be ordered and fitted before the hood can be used.

The hood should be installed away from particularly dirty areas, windows, doors and heat sources.

The hood is sold with all necessary components for installation on most types of walls or ceilings. However, ask a qualified technician to check that the items supplied are suitable for the type of wall/ceiling.

Keep this booklet for future consultation.

Product description

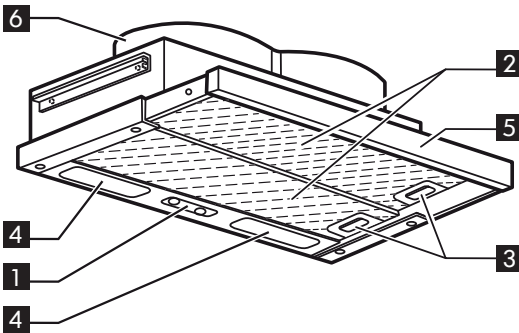

- 1 Control Panel.
- 2 Grease filter.
- 3 Grease filter spring release handles.
- 4 Lighting unit.
- 5 Pull-out steam deflector.
- 6 Extractor unit body.

Control panel

- A** Light switch.
The switch has two positions (lights OFF - lights ON).
To switch on the lights: move the switch to the right.
- B** Motor switch.
The extraction speed switch has 3 settings, depending on the amount of steam and fumes.
To increase the extraction speed: move the switch to the right.

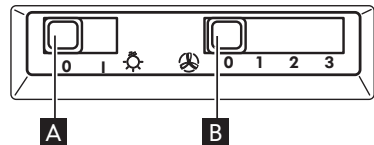

Cleaning and maintenance

- ⚠ WARNING:**
 - Never use steam cleaning equipment.
 - Disconnect the appliance from the power supply.
- IMPORTANT:** do not use corrosive or abrasive detergents. If any of these products accidentally comes into contact with the appliance, clean immediately with a damp cloth.
 - Clean the surfaces with a damp cloth. If it is very dirty, add a few drops of washing up detergent to the water. Finish off with a dry cloth.

- IMPORTANT:** do not use abrasive sponges or metallic scrapers or scourers. Over time, these can ruin the surface.
 - Use detergents specifically designed for cleaning the appliance and follow the manufacturer instructions.

IMPORTANT: clean the filters at least monthly to remove any oil or grease residuals.

To clean the grease filter

The metal grease filter has an unlimited life and must be washed once a month by hand or dishwasher at low temperature and with

a short cycle. With cleaning in a dishwasher the grease filter may become dull; this does not effect its filtering capacity.

Grease filter maintenance:

1. Unplug the appliance or disconnect the power supply.
2. Remove the grease filters: pull the spring release handle, then remove the filter downwards.
3. After cleaning the grease filter, remount in reverse order ensuring the entire extraction surface is covered.

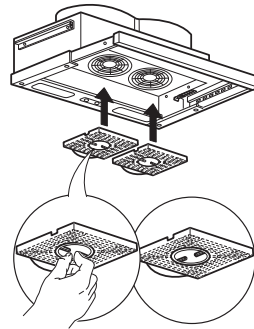
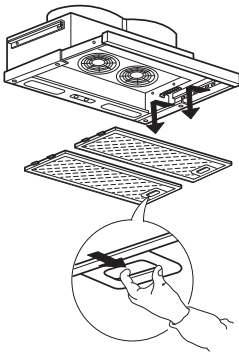

Lamp maintenance

1. Disconnect the electrical power supply.
2. Use a small screwdriver or any other suitable tool to prise off the lamp cover
3. Remove the burnt-out bulb.
4. Replace using 40 W max incandescent or 28W max halogen E14 bulbs only.
5. Replace the lamp cover so that it clicks into position.

IMPORTANT: make sure you don't touch the lamp with your hands.

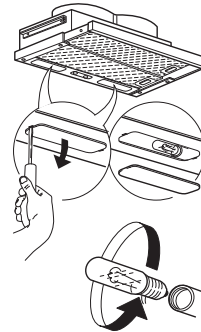

Charcoal filter maintenance

1. Disconnect the electrical power supply.
2. Remove the grease filter/s
3. If the charcoal filters are already mounted and need renewing, turn the central handle anticlockwise until the filters release.
4. If the charcoal filters are not already mounted, locate the filters to cover the motor protection grilles (two protection grilles - two charcoal filters), then turn the central handle of the filters clockwise.
5. Refit the grease filter/s

Charcoal filter is neither lavable nor regenerable. Replace it every 4 months.

What to do if ...

Problem	Possible cause	Solution
The appliance does not work	There is no mains electrical power	Check for the presence of mains electrical power. Turn off the appliance and restart it to see if the faults persists.
	The appliance is not connected to the electrical supply	Check if the appliance is connected to the electrical supply. Turn off the appliance and restart it to see if the faults persists.
The hood's suction level is not enough	The suction speed is too low	Check the suction speed and adjust as necessary.
	The metal filters are dirty	Check that the filters are clean If not, clean the filters in the dishwasher.
	The air vents are obstructed	Check the air vents for any obstructions and remove as necessary.
The light does not work	The light bulb is broken	Check the light bulb and replace it if necessary.
	The light bulb is not correctly fitted	Check that the light bulb has been correctly fitted. If not, fit the light bulb in right way.

Before contacting the After-sales service:

Switch the appliance on again to see if the problem has disappeared. If not, switch it off again and repeat the operation after an hour.

If your appliance still does not work properly after carrying out the checks listed in the troubleshooting guide and switching the appliance on again, contact the After-sales service, clearly explaining the problem and specifying:

- the type of fault;
- the model;
- the type and serial number of the appliance (given on the rating plate);
- the Service number (the number after the word SERVICE on the rating plate inside the appliance).

SERVICE 0000 000 00000



Technical data

Dimensions (mm)	Width	598
	Height	173
	Depth	279
Airflow max - Exhaust (m ³ /h)		325
Noise max - Exhaust (dBa)		64
Airflow max - Recirculating (m ³ /h)		240
Noise max - Recirculating (dBa)		66
Total Power (W)		320
Lamps		2 x 40W
Installation minimum height dimensions (cm)	gas or combi cookers	65
	electric cookers	50

The technical information are situated in the rating plate on the internal side of the appliance and in the energy label.

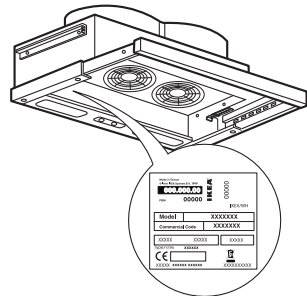

Environmental concerns

Disposal of packing

The packing material is 100% recyclable and is marked with the recycle symbol . The various parts of the packing must therefore be disposed of responsibly and in full compliance with local authority regulations governing waste disposal.

Scrapping the product

- This appliance is marked in compliance with European Directive 2002/96/EC, Waste Electrical and Electronic Equipment (WEEE).
- By ensuring this product is disposed of correctly, you will help prevent potential negative consequences for the environment and human health, which could otherwise be caused by inappropriate waste handling of this product.



The symbol  on the product or on the accompanying documentation indicates that it should not be treated as domestic waste but must be taken to an appropriate collection centre for the recycling of electrical and electronic equipment.

Scrapping of household appliances

- This appliance is manufactured with recyclable or reusable materials. Dispose of it in accordance with local waste disposal regulations. Before scrapping, cut off the power supply cable.
- For further information on the treatment, recovery and recycling of household electrical appliances, contact your competent local authority, the collection service for household waste or the store where you purchased the appliance.

Declaration of conformity



- This appliance has been designed, manufactured and marketed in compliance with:
 - safety objectives of the “Low Voltage” Directive 2006/95/EC (which replaces 73/23/EEC and subsequent amendments);
 - the protection requirements of Directive “EMC” 2004/108/EC.

Electrical safety of the appliance can only be guaranteed if it is correctly connected to an approved earthing system.

Electrical connection for Australia

Power Cord and Plug: Declared Article – Mandatory Approval Applies:
Current Australian Approval Certificates will need to be forwarded, showing compliance with applicable Australian Standards, as noted below. Plug to have insulated pins. Plug and Cord to have approval marking, as required by the relevant Approval Certificate

- AS/NZS 3112: 2004 with Amendment 1, for Plug
- AS 3191: 2008, for Cord, or;
- 'HAR' Certification, for Cord

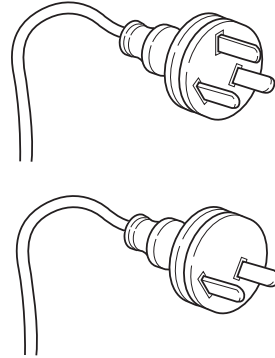

IKEA GUARANTEE

How long is the IKEA guarantee valid?

This guarantee is valid for five (5) years from the original date of purchase of your appliance at IKEA, unless the appliance is named LAGAN in which case two (2) years of guarantee apply. The original sales receipt, is required as proof of purchase. If service work is carried out under guarantee, this will not extend the guarantee period for the appliance.

Which appliances are not covered by the IKEA five (5) years guarantee?

The range of appliances named LAGAN .

Who will execute the service?

IKEA has appointed Whirlpool (Australia) Pty Ltd as the authorised service network partner.

- If you encounter any trouble with the appliance and wish to register a call with Whirlpool, please call:

**Australia contact centre:
1300 363 344.**

What does this guarantee cover?

The guarantee covers applicable faults of the appliance, as per the terms and conditions,

from the date of purchase from IKEA. This guarantee applies to domestic use only. The exceptions are specified under the headline “What is not covered under this guarantee?” Within the guarantee period, the costs to remedy the fault e.g. repairs, parts, labour and travel will be covered, provided that the appliance is accessible for repair without special expenditure. Replaced parts become the property of IKEA.

The services will be in-home service for domestic appliances, and must to be done by official Whirlpool service network. Goods presented for repair may be replaced by refurbished goods of the same type rather than being repaired.

Refurbished parts may be used to repair the goods.

If the authorized service agent requests you to deliver the product directly to them, please ensure that the appliance is suitably packaged to prevent any damage during transportation.

What will IKEA do to correct the problem?

IKEA appointed service provider will examine the product and decide, at its

sole discretion, if it is covered under this guarantee. If considered covered, IKEA service provider or its authorized service partner through its own service operations, will then, at its sole discretion, either repair the defective product or replace it with the same or a comparable product.

What is not covered under this guarantee?

- Normal wear and tear.
- Deliberate or negligent damage, damage caused by failure to observe operating and maintenance instructions, incorrect installation or by connection to the wrong voltage, damage caused by chemical or electrochemical reaction, rust, abrasion or scratching, corrosion or water damage including but not limited to damage caused by excessive lime in the water supply, damage caused by abnormal environmental conditions.
- Damage caused from the use of the appliance in a manner other than the use for which it was specifically designed.
- Damage caused by power outages, electrical power surge or improper supply voltage via connection to Supply Authority mains or alternative supply systems.
- Consumable parts including batteries and lamps, removable wire, glass and plastic trays and other accessories.
- Internal or external damage as a result of excessive use of cleaning products or cleaning agents.
- Non-functional and decorative parts which do not affect normal use of the appliance, including any scratches and possible color differences.
- Accidental damage or blockages caused by foreign objects, eg. coins, underwires, nails, buttons or jewellery, or substances and cleaning or unblocking of filters, drainage systems or soap drawers
- Damage caused by vermin, insects or pets.
- Note – internal or external cabinet transport damage must be reported within 7 days of purchase date.
- Damage to the following parts: ceramic glass, accessories, crockery and cutlery baskets, feed and drainage pipes, seals, lamps and lamp covers, screens, knobs, casings and parts of casings. Unless such damages can be proved to have been caused by production faults.
- Cases where no fault could be found during a technician's visit.
- Any consequential loss due to appliance failure.
- Repairs not carried out by our appointed service providers and/or an authorized service contractual partner or where non original parts have been used.
- Repairs to parts or systems caused by unauthorized modifications made to appliance.
- Repairs caused by installation which is faulty or not according to specification.
- Problems caused by incorrect or inadequate venting of the appliance.
- The use of the appliance in a non domestic environment i.e. professional use.
- Transportation damages. If a customer transports the product to his home or another address, IKEA is not liable for any damage that may occur during transport.
However, if IKEA delivers the product to the customer's delivery address, then damage to the product that occurs during this delivery will be covered by IKEA.
- Cost for carrying out the initial installation of the IKEA appliance. However, if an IKEA appointed service provider or its authorized service partner repairs or replaces the appliance under the terms of this guarantee, the appointed service provider or its authorized service partner will reinstall the repaired appliance or install the replacement, if necessary.

- The benefits conferred by this express warranty are in addition to all other conditions, warranties, guarantees, rights and remedies expressed or implied by the Trade Practices Act and similar State and Territory laws and all other obligations and liabilities on the part of the manufacturer or supplier and nothing contained herein shall restrict or modify such rights, remedies, obligations or liabilities.

How country law applies?

Our goods come with guarantees that cannot be excluded under the Australian Consumer Law.

You are entitled to a replacement or refund for a major failure and for compensation for any other reasonably foreseeable loss or damage.

You are also entitled to have the goods repaired or replaced if the goods fail to be of acceptable quality and the failure does not amount to a major failure.

Area of validity

The IKEA guarantee applies only to products purchased and installed in AUSTRALIA .

The dedicated AFTER SALES for IKEA appliances

Please don't hesitate to contact IKEA appointed After Sales Service Provider to:

- make a service request under this guarantee;
- ask for clarifications on installation of the IKEA appliance in the dedicated IKEA kitchen furniture;
- ask for clarification on functions of IKEA appliances.
- Call our authorized service network partner Whirlpool on **1300 363 344 (Australia)**.

WARRANTY PROCEDURE

Please ensure that installation procedure entailed in the user manual has been adhered to and in case of any doubts please

refer to the trouble shooting guide that has been supplied with the appliance.

- Please read the user guide to ensure that you are aware of all the features & benefits of the appliance.

How to reach if you need our service

The Whirlpool call centre team will assist you on the phone with basic trouble shooting for your appliance at the time of warranty call registration.



1300 363 344

Please describe the problem that you are facing with the appliance in detail along with your product model number, serial number, date of purchase at the time of call registration.

Please also always refer to the IKEA article number (8 digit code) and 12 digit service number placed on the rating plate of your appliance.

i SAVE THE SALES RECEIPT!

Kindly keep all these details and original invoice of purchase handy during the service technician's visit to enable him to carry out the job.

i Whirlpool reserves the right not to register the call under warranty if you fail to provide these details at the time of call registration.

Do you need extra help?

For any additional questions not related to After Sales of your appliances please contact your nearest IKEA store call centre. We recommend you read the appliance documentation carefully before contacting us.

For details on service agents locations, please visit – www.whirlpool.com.au/services.

