

TERA

www.tera.co

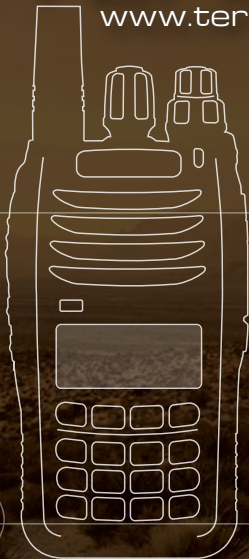

User Manual

TR-590

TERA

Thank you for purchasing TERA model TR-590. This dual-band VHF/UHF two-way radio features up to 200 channels, 5 watt output, alpha-numeric display and true dual receive. This radio can operate up to 20 hours on a single charge with its included 1600 mAh Li-ion battery.

2

To get the most out of your radio, please read this manual carefully before use.

◆ Initial Programming

This commercial handheld radio ships from the manufacture “Displayed Locked” per FCC rules. You must first use the programming software to unlock this radio for the first time of use. You will need the programming cable to connect your radio to your computer for programming. Please contact your dealer for radio programming software.

When programming this radio for the first time , it is recommended you first READ the radio with the software and then save this file for future reference. In addition, after you READ this radio with software, first make your programming and frequency changes, then send this edited file back to your radio. Please contact the dealer you purchased this radio from or TERA should you have any questions.



TERA

Online Service and Support

The TERA website provides additional information about obtaining service or support for the TERA line of two-way radios and accessories.

4

Visit: www.tera.co

User Manual

Safety Matters

The following recommendations will help you understand this radios safety requirements.

1. Only qualified TERA technicians are allowed to service this two-way radio. Do not disassemble the radio by yourself as it will void the warranty.
2. Use only the TERA brand battery pack and desk charger, so as to not damage the transceiver.
3. Do not expose this radio to long periods of direct sunlight, or hot or humid areas.
4. Do not put this radio in dusty or dirty locations.
5. Do not use harsh chemicals, cleaning solvents, or strong detergent to wash this radio.
6. Never transmit on this radio without an antenna.



Caution

» Safety and operability of this radio can't be guaranteed unless TERA brand accessories or parts are used.

◆ Content



Initial Programming	3	Squelch Level Setting (MENU 1)	25
Included In Box	9	Transmit Power Selection (MENU 2)	26
Getting Acquainted	10	Channel Step Frequency (MENU 3)	26
Battery Information	10	Wide / Narrow Band Set (MENU 4)	27
Charge Operation	11	Repeater Offset or Shift (MENU 5)	27
Antenna Information	13	Repeater Offset Frequency Dir (MENU 6) ..	28
Radio Overview	14	Receive CTCSS / DCS Code (MENU 7)	28
Screen	14	Transmit CTCSS / DCS Code (MENU 8)	29
Basic Operations	16	Scan Add (MENU 9)	29
Switch ON/OFF	16	Scan Method (MENU 10)	30
Volume Adjustment	16	Lock (MENU 11)	30
Monitor Function	17	Keyboard Auto-lock (MENU 12)	31
Make A Call	17	Coded Squelch Freq. Scan (MENU 13)	31
Receive A Call	17	BootSnd (MENU 14)	32
Factory Default	18	Beep Tone Setting (MENU 15)	32
Side Key Custom-Setting	18	Flashlight Set (MENU 16)	33
Function Shortcuts Process	20	Auto Backlight Set (MENU 17)	33
Functions Operating Instructions	25	RxTxLED (MENU 18)	34
Scan Mode (MENU 0)	25	FM Radio (MENU 19)	34

FM Radio (MENU 20).....	35
Timer Set (MENU 21)	35
Single / Dual Display Mode (MENU 22).....	36
Single Display (MENU 23).....	36
Transmit Time Out Timer (MENU 24).....	37
Busy Channel Lock Out (MENU 25)	37
Squelch Mode (MENU 26)	38
Squelch-Tail Eliminate (MENU 27)	38
Power Save (MENU 28).....	39
VOX Control (MENU 29)	39
VOX Delay (MENU 30).....	40
Edit & Save Channel Name (MENU 31).....	40
Memory Channel Store (MENU 32)	41
Memory Channel Delete (MENU 33).....	41
Reset.....	42
Reverse Frequency Function.....	42
Main Band Operation A/B Switch	42
VFO or Memory Channel Mode.....	43
Wired Clone	44

Troubleshooting	45
Specification	47
Optional Accessories	49
Service and Support.....	50
Warranty and Repair Services	50
Terms of Warranty	52
Warning Notes.....	54
Safety.....	55



Check Product

» Please unpack the radio and the included accessories. We recommend that you check the box for the items listed below to ensure everything is in the box.

Please contact your dealer should any items be missing from the box.

◆ Included In Box



Radio

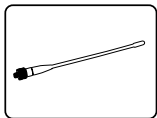

Antenna

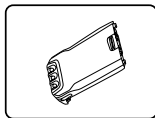

Battery

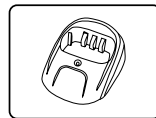

Charger

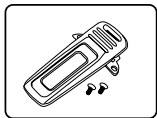

Belt Clip

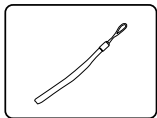

Hand Strap

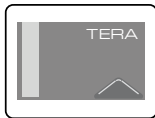

User Manual



◆ Getting Acquainted

Battery Information

Battery Type: Li-Ion 1600 mAh Battery. Please charge the included TERA battery for 1-2 hours before use. Leave the radio or battery pack in the supplied charger cup until the red charging light goes off and the green LED light comes on which indicates the battery pack is fully charged and ready to use.

Note:

1. Do not short-circuit the battery terminals or dispose the battery in fire. Never attempt to disassemble the battery pack.
2. Charge the battery in 32-105°F temperature. Otherwise the battery may not fully charge.
3. Turn off the radio before your initial charge. Use of the radio while charging may cause noise or interfere during reception or transmission.
4. Do not pull/plug the adapter and the battery during charging to avoid interference with the charging procedure.
5. If the battery life quickly runs down even if it is fully and correctly charged, this means the battery life is over and this battery will need replacing. Please contact your authorized TERA dealer to purchase a new battery.

6. NEVER charge the battery or radio with battery if they are wet. Before charging, you should dry them off with a towel or cloth to avoid danger.

Warning:

Conductive metals such as jewelry, keys or decorating lace may result in short circuit and generate a large quantity of heat when coming to contact with battery electrodes. Treat any battery carefully especially when placing it into pocket, wallet or other metal container as they can short out.

Charge Operation

Please charge as follows:

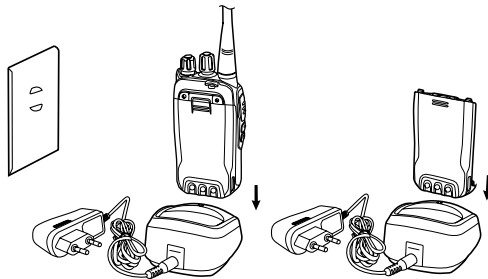

1. Turn off the radio.
2. Plug the AC connector of adapter into an AC output socket

3. Vertically insert the battery or radio equipped with battery into the charger. Make sure the charger and battery is well contacted.
4. After the radio and/or battery are inserted into the charger, the LED glows red and that means the charger is ready for normal charging; if the LED flashes red, it means the remaining battery power is too low and a trickle charge is in process. After the battery power has reached a certain amount during trickle charge, the charger automatically turns to normal (fast) charge mode (solid Red colored LED).
5. The battery is fully charged (97%-100%) when LED glows green. The charger stops charging automatically.

12

Note

» Trickle charge is not allowed to exceed 30 minutes. If the LED is still flashing in red after 30 minutes, it means that the charger cannot provide power to the battery. Check if the battery or charger is damaged.

Caution when Charging the Battery

1. The battery is not fully charged from the factory. Please charge the battery before initial use or after long-period of storage.
2. Repeat charging 2 to 3 times will make the battery reach its best capacity. Please replace or

charge the battery if battery power is low.

3. The supplied Li-ion battery includes a (6) six month warranty and is good for typically 400-500 charging cycles.

TIP

» When storing radio for more than 3 weeks at a time, it is best to remove the TERA battery from radio. This will maintain a full charge in battery so it's ready for use. Batteries will hold a charge 6-12 months when removed from radio.

Antenna Information

The supplied flexible antenna is suitable for standard-distance communications. TERA also offers extended length higher gain antennas to increase your communications range. For more information about available accessories, visit: www.tera.co

CAUTION

» Radio communication range may be greatly reduced when operating inside of concrete structures like buildings and parking structures.

◆ Radio Overview

Screen

14

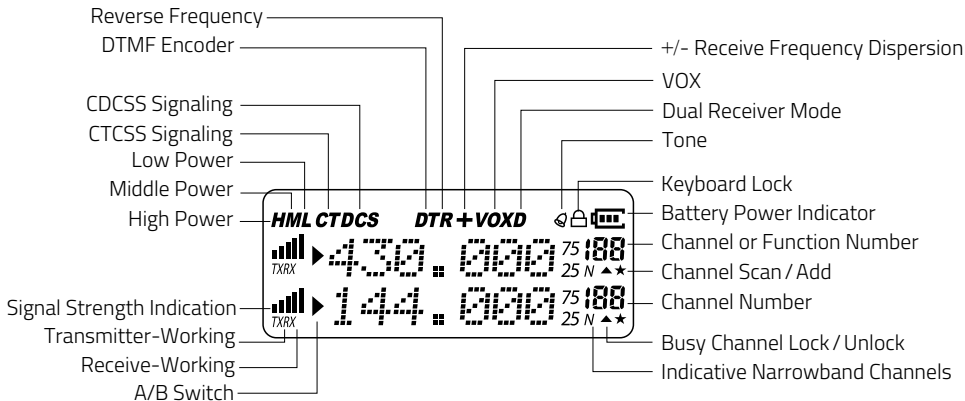

Battery Status Indicator:



Full



Power Remaining



Battery exhausted. Please change out battery or charge it.

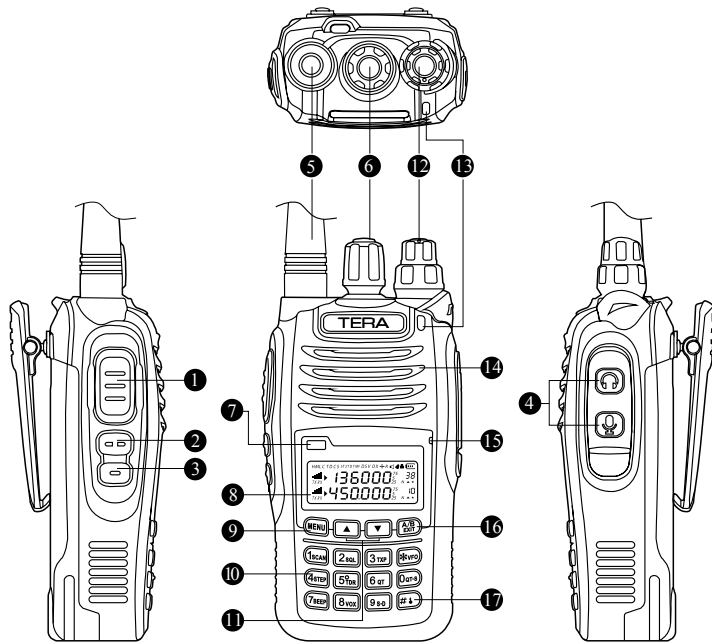

- ① PPT Key
- ② Programmable SK1
- ③ Programmable SK2
- ④ Earphone / Speaker Mic Jack
- ⑤ Antenna
- ⑥ Channel Selector
- ⑦ Flashlight
- ⑧ LCD
- ⑨ Function Key
- ⑩ Number Keys
- ⑪ Up/Down key
- ⑫ Power Switch
/ Volume Control of the top frequency
Volume Control of the bottom frequency
- ⑬ LED Indicator
- ⑭ Speaker
- ⑮ Microphone
- ⑯ Exit
- ⑰ Lock

◆ Basic Operations

Switch ON/OFF

Rotate the top right knob clockwise until a “Du” sound and a “Ka Ta” sound, to confirm that the radio’s power is on; Rotate the top right knob counter-clockwise until a “Ka Ta” sound means to turn off the radio.

16

Volume Adjustment

Rotate the power control button/volume controller clockwise to turn on the radio, rotate further to adjust the desired volume.

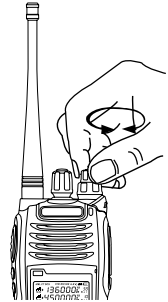

Monitor Function

A weak signal that is hardly heard during normal operation process can be monitored by pressing [bottom left side key]. Volume can be adjusted by rotating the power control button/volume controller even if there is lack of signal. Release [bottom left side key] to go back to normal radio operation.

Make A Call

To make a call, hold down [PTT] key and speak into the microphone with normal voice. Please keep the microphone 3 to 5 inches away from your mouth.

Note:

1. Hold down [PTT] key and the LED glows red, the radio begins to transmit.
2. If LED flashes red during TX, the battery needs re-charging. The radio can not transmit when battery is low. Reduce your TX power level or recharge the battery as soon as possible.

Receive A Call

Release [PTT] key to receive a call. Adjust squelch in programming to receive signal.



Emergency Alert Function

This function is enabled by key settings and/or your dealer. Long press [Middle key] to activate this function. The radio will send out alarm and make alarm sound.

Factory Default

Short-press SK1 key, to enable flashing flashlight; Long-press SK1 key, to turn the flashlight on.

18

Side Key Custom-Setting

The User can set customization features for side key (SK1, SK2) with the software.

Long-press can set the following function:



Choose: Momentary monitoring; Timer; Scan; FM Radio; Anti-interference scanning; Alarm; Flashlight

Short-press can set the following function:

Choose: Quiet monitoring; Timer; Scan; FM Radio; Anti-interference scanning; Alarm;

◆ Function Shortcuts Process

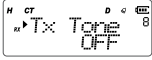
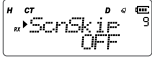
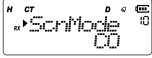
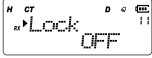
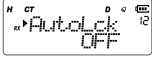
ID	Name	Function Shortcut	Screen Display	Setting	Select	Optional Parameter	Confirm Setting	Return to Standby
0	Scan Mode	"MENU" + "0"			Press ▲ or ▼ to start scan functions			"A/B EXIT"
1	Squelch Level Setting	"MENU" + "1"		"MENU"	Press ▲ or ▼ to select	Set Squelch Level 0-9; Default Squelch Level = 5	"MENU"	"A/B EXIT"
2	Transmit Power	"MENU" + "2"		"MENU"	Press ▲ or ▼ to select	HIGH: high power; MID: medium; LOW: low power output	"MENU"	"A/B EXIT"
3	Step Frequency	"MENU" + "3"		"MENU"	Press ▲ or ▼ to select	Step Frequency: 2.5kHz, 5kHz, 6.25kHz, 10kHz, 12.5kHz, 25kHz, 50kHz, 100kHz	"MENU"	"A/B EXIT"
4	Wide / Narrow Band	"MENU" + "4"		"MENU"	Press ▲ or ▼ to select	WIDE: wide band (25kHz) NARROW: narrow band (12.5kHz)	"MENU"	"A/B EXIT"
5	Repeater Offset Frequency	"MENU" + "5"		"MENU"	Press ▲ or ▼ to select	0~99.995MHz optional. 00.600MHz for VHF 05.000MHz for UHF	"MENU"	"A/B EXIT"
6	Repeater Shift Direction	"MENU" + "6"		"MENU"	Press ▲ or ▼ to select	+: plus frequency shift -: minus frequency shift OFF: No TX shift (simplex)	"MENU"	"A/B EXIT"
7	Receive CTCSS/DCS Tone	"MENU" + "7"		"MENU"	Press ▲ or ▼ to select tone. Press # to choose between CTCSS, DCS, OFF	50 sets of CTCSS tones (67.0Hz~254.1Hz) 105 sets digital tones (D023N~D754N) 105 sets reverse digital tones (D023I~D754I)	"MENU"	"A/B EXIT"

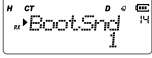
ID	Name	Function Shortcut	Screen Display	Setting	Select	Optional Parameter	Confirm Setting	Return to Standby
8	Transmit CTCSS/DCS Tone	"MENU" + "8"		"MENU"	Press ▲ or ▼ to select tone. Press # to choose between CTCSS, DCS, OFF	50 sets of CTCSS tones (67.0Hz~254.1Hz) 105 sets digital tones (D023N-D754N) 105 sets reverse digital tones (D023I-D754I)	"MENU"	"A/B EXIT"
9	Add Channel To Scan	"MENU" + "9"		"MENU"	Press ▲ or ▼ to select	ON: scan add OFF: scan delete	"MENU"	"A/B EXIT"
10	Scan Method	"MENU" + "10"		"MENU"	Press ▲ or ▼ to select	TO: time scan CO: carrier scan SE: search for scan	"MENU"	"A/B EXIT"
11	Select Lock Mode	"MENU" + "11"		"MENU"	Press ▲ or ▼ to select	All DIAL KEY	"MENU"	"A/B EXIT"
12	Keypad Automatic Locking	"MENU" + "12"		"MENU"	Press ▲ or ▼ to select	ON: turn on OFF: turn off	"MENU"	"A/B EXIT"
13	CTCSS/DCS Tone Search	"MENU" + "13"		"MENU"	Press ▲ or ▼ to select	CTCSS / DCS Tone Scanning	"MENU"	"A/B EXIT"
14	Power-Up Sound	"MENU" + "14"		"MENU"	Press ▲ or ▼ to select	"1" "2" or "3" startup tones. Default selection is "1".	"MENU"	"A/B EXIT"



ID	Name	Function Shortcut	Screen Display	Setting	Select	Optional Parameter	Confirm Setting	Return to Standby
15	Tone Setting	"MENU" + "15"		"MENU"	Press ▲ or ▼ to select	OFF: no tone ON: "beep" tone	"MENU"	"A/B EXIT"
16	Flash Light	"MENU" + "16"		"MENU"	Press ▲ or ▼ to select	ON: turn on OFF: turn off	"MENU"	"A/B EXIT"
17	Automatic Backlight	"MENU" + "17"		"MENU"	Press ▲ or ▼ to select	ON: keeps backlight turned on AUTOKEY: turn on backlight when key pressed AUTOALL: all action including side key and signal-receipt turn on backlight OFF: keeps automatic backlight turned off	"MENU"	"A/B EXIT"
18	RxTxLED	"MENU" + "18"		"MENU"	Press ▲ or ▼ to select	ON: turn on OFF: turn off	"MENU"	"A/B EXIT"
19	FM Radio	"MENU" + "19"		"MENU"	Press ▲ or ▼ to select	ON: FM radio on OFF: FM radio off	"MENU"	"A/B EXIT"
20	FM Radio Monitor Mode	"MENU" + "20"		"MENU"	Press ▲ or ▼ to select	ON: receive OFF: receive disabled	"MENU"	"A/B EXIT"
21	Timer	"MENU" + "21"		"MENU"	Press ▲ or ▼ to select	ON: turn on OFF: turn off	"MENU"	"A/B EXIT"

ID	Name	Function Shortcut	Screen Display	Setting	Select	Optional Parameter	Confirm Setting	Return to Standby
22	RX Mode	"MENU" + "23"		"MENU"	Press ▲ or ▼ to select	SINGLE: single receive mode DUAL: dual receive mode	"MENU"	"A/B EXIT"
23	SglDisp	"MENU" + "23"		"MENU"	Press ▲ or ▼ to select	VOLTAGE or BLANK Default selection is VOLTAGE.	"MENU"	"A/B EXIT"
24	TX Timer	"MENU" + "24"		"MENU"	Press ▲ or ▼ to select	OFF: close; 30s, 60s, 90s, 120s, 150s, 180s, 210s, 240s, 270s, 300s	"MENU"	"A/B EXIT"
25	Busy Channel Lock Out	"MENU" + "25"		"MENU"	Press ▲ or ▼ to select	Busy channel lock-out function on or off; Default is off	"MENU"	"A/B EXIT"
26	Sql Mode	"MENU" + "26"		"MENU"	Press ▲ or ▼ to select	1, 2, or 3; Default selection is 2	"MENU"	"A/B EXIT"
27	Voice Tail Eliminate	"MENU" + "27"		"MENU"	Press ▲ or ▼ to select	Turns off CTCSS TX before unkey Default is off	"MENU"	"A/B EXIT"
28	RX Power Save	"MENU" + "28"		"MENU"	Press ▲ or ▼ to select	OFF: close SIMPLE: regular power consumption AUTO: smart power consumption	"MENU"	"A/B EXIT"



ID	Name	Function Shortcut	Screen Display	Setting	Select	Optional Parameter	Confirm Setting	Return to Standby
29	VOX Setting	"MENU" + "29"		"MENU"	Press ▲ or ▼ to select	VOX level 1-9 OFF: turns VOX off	"MENU"	"A/B EXIT"
30	VOX Delay Time	"MENU" + "30"		"MENU"	Press ▲ or ▼ to select	0.3s-5.0s;	"MENU"	"A/B EXIT"
31	Channel Name Edit	"MENU" + "31"		"MENU"	Press ▲ or ▼ to select	Edits the current name of the channel	"MENU"	"A/B EXIT"
32	Memory Channel Store	"MENU" + "32"		"MENU"	Press ▲ or ▼ to select	Save the current frequency into a memory channel	"MENU"	"A/B EXIT"
33	Memory Channel Delete	"MENU" + "33"		"MENU"	Press ▲ or ▼ to select	Deletes the selected memory channel	"MENU"	"A/B EXIT"

All menu operation is to press "MENU" key to confirm, and press "Exit" key to quit. Use knob or keys to select, long-press 2 sec. into quick select mode in the select interface of menu.

◆ Functions Operating Instructions

Scan Mode (MENU 0)

Press "MENU" + number 0 in standby mode, and the radio will start scanning.

Squelch Level Setting (Sql Levl • MENU 1)

Squelch Level Setting is to choose to open or close squelch when signal strength is strong or weak. A high squelch setting will block weak signals. A setting too low will exposes you to noise or other unrelated signals. There is 0~9 levels, 1=low, 9=highest. Among them, level 0 is always open squelch. A setting of "5" is the default squelch setting for this radio.

Press "MENU" + number 1 in standby mode, screen displays:

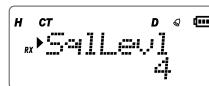

Then, press "MENU", arrow points to number 4, press ▲ / ▼ to select squelch level, then press "MENU" to confirm, press "EXIT" back to standby mode.

Transmit Power Selection (Tx Power • MENU 2)

Press "MENU" + number 2 in standby mode, screen displays:



Right after, press "MENU", arrow points "High" place, press ▲ / ▼ to select HIGH / MID / LOW mode, press "MENU" to confirm, press "EXIT" back to standby. (High=5W, Mid=2.0W, Low=0.5W)

26

Channel Step Frequency Setting (Step • MENU 3)

Press "MENU" + number 3 in standby mode, screen displays:

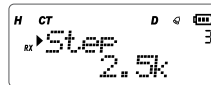

Then, press "MENU", arrow points "5K" place, press ▲ / ▼ to select required step frequency, press "Menu" to confirm, press "EXIT" back to standby. There are eight step frequencies to select: 2.5K, 5K, 6.25K, 10K, 12.5K, 25K, 50K, 100KHz

Wide / Narrow Band Set (Bndwidth • MENU 4)

Press "MENU" + number 4 in standby mode, screen displays:

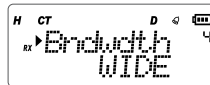

Right after, press "Menu", arrow points "WIDE" place, press ▲ / ▼ to select NARROW 12.5K or WIDE 25K, press "Menu" to confirm, press "EXIT" back to standby.

Repeater Offset or Shift Amount (Offset • MENU 5)

Repeater Shift or Offset amount means the difference between transmitting frequency and receiving frequency. Shift amount for this radio is 0~99.995MHz. Typical shift amount are 0.600 on VHF and 5.000 MHz on UHF which are the default settings.

Press "MENU" + number 5 in standby mode, screen displays:



Then, press " Menu", arrow points "00.000" place, press ▲ / ▼ to select frequency of Shift Frequency, or input it by keyboard, press "Menu" to confirm, press "EXIT" back to standby.

Repeater Offset Frequency Direction (Rpt Dir • MENU 6)

Press "MENU" + number 6 in standby mode, screen displays:

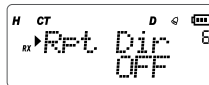

At that instant, press "MENU", arrow points "OFF" place, press ▲ / ▼ to select one of OFF / + / - mode, press "MENU" to confirm, press "EXIT" back to standby.

Radio won't transmit if the transmission Shift Frequency is above or below the allowable range. Under this condition, please adjust receive frequency or frequency difference of the Shift Frequency into allowable range.

28

Receive CTCSS / DCS Code Set (Rx Tone • MENU 7)

Press "MENU" + number 7 in standby mode, screen displays:

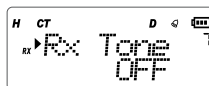

Right after, press "MENU", arrow points "OFF", and press # key to select CTCSS or DCS Receive code, or press ▲ / ▼ to select one of 67.0 Hz/D023N/D023I, press "MENU" to confirm, press "EXIT" back to standby.

Transmit CTCSS / DCS Code Set (Tx Tone • MENU 8)

Press "MENU" + number 8 in standby mode, screen displays:

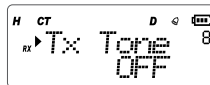

Then, press "MENU", arrow points "OFF", and press # key to select CTCSS or DCS Receive code, or press ▲ / ▼ to select one of 67.0 Hz/D023N/D023I, press "MENU" to confirm, press "EXIT" back to standby.

Scan Add (ScnSkip • MENU 9)

Press "MENU" + number 9 in standby mode, screen displays:



Then, press "MENU", arrow points "ON", press ▲ / ▼ to select ON to add current channel into scan list, or select "OFF" to delete current channel from scan list, press "MENU" to confirm, press "EXIT" back to standby.

Scan Method (Scn Mode • MENU 10)

CO: carrier scan, stop scan when get signal and continue to scan if exceed scan-pause time when signal is lost

SE: searching scan, scan and save when get signal, quit scan mode.

TO: time scan, continue to scan if exceed scan-pause time whether signal is lost or not.

Press "MENU", then rotate the top selector knob to select "Menu 10", screen displays:



Next, press "MENU", arrow points "CO", press \blacktriangle / \blacktriangledown to select one of CO / SE / TO method, press "MENU" to confirmed, press "EXIT" back to standby. "CO" is the default scan mode.

Lock (Lock • MENU 11)

The lock feature allows you to select which parts of the radio will lock when you press the front keypad lock icon. User can

select "KEY" which will lock the keypad but user can still rotate top channel knob. "DIAL" locks the top selector knob but keypad is still active. "ALL" locks the keypad and top selector knob. Default selection is "KEY" which locks the keypad only.

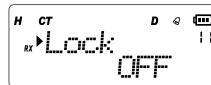

Press "MENU", then rotate the top selector knob to select "Menu 11". Right after, press the "MENU" button and rotate the top selector knob the select (KEY, DIAL, or ALL). After making a selection press "MENU" again to confirm selection and exit the menu.

Keyboard Auto-lock (AutoLck • MENU 12)

Press "MENU", then rotate the top selector knob to select "Menu 12", the screen displays:

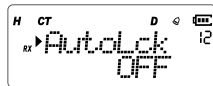

Right after, press "MENU", arrow points "OFF", press ▲ / ▼ to select OFF to turn off this function or turn it on, press "MENU" to confirm, press "EXIT" back to standby.



Coded Squelch Frequency Scan (TnSrch • MENU 13)

Coded Squelch Frequency Scan accompanied with working frequency, CTCSS: Analog anti-interference; DCSI: reverse digital tamper-proof code. It shows "CT" sign when scan CTCSS, shows "DCS" sign when scan DCS N, shows "search" when searching, then screen displays CTCSS or DCS code scanned.

Press "MENU", then rotate the top selector knob to select "Menu 13", screen displays:

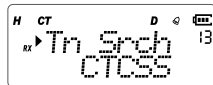

Then, press "MENU", arrow points "CTCSS", and press ▲ / ▼ to select one of CTCSS/DCS I/DCS N mode, press "MENU" to confirm. Radio will scan tones and display on screen. To cancel press MENU.

BootSnd (BootSnd • MENU 14)

The BootSnd function allows the user to select one of three tone sequences when the radio is turned ON. User can select "1" "2" or "3" startup tones. Default selection is "1".

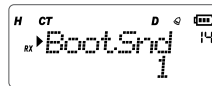

Press "MENU" then rotate the top selector knob to select "Menu 14". Right after, press the "MENU" button and rotate the top selector knob the select ("1" "2" or "3"). After making a selection press "MENU" again to confirm selection and exit the menu.

Beep Tone Setting (Beep • MENU 15)

Press "MENU", then rotate the top selector knob to select "Menu 15", screen displays:

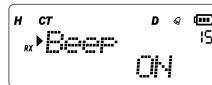

Then, press "MENU", arrow points "ON", press ▲ / ▼ to select OFF, turn off beep tone, or select ON, turn on the beep tone, press "MENU" again to confirm selection and exit the menu.

Flashlight Set (FlashLt • MENU 16)

Press "MENU" then rotate the top selector knob to select "Menu 16", screen displays:

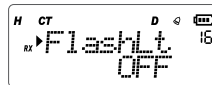

At that instant, press "MENU", arrow points "OFF", press ▲ / ▼ to select to turn flashlight on or off. Press "MENU" to confirm, press "EXIT" back to standby.

Auto Backlight Set (Lamp • MENU 17)

Auto backlight set will turn off backlight if no action after 6 secs. OFF: turn off; AUTOKEY: turn on backlight when keyboard is operating; AUTOALL: turn on backlight if there is any action, including in receiving signal.

Press "MENU", then rotate the top selector knob to select "Menu 17", screen displays:

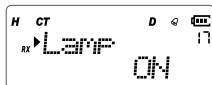

Then, press "MENU", arrow points "KEY", press ▲ / ▼ to select one of these options: AUTOKEY / OFF / AUTOALL, press "MENU" to confirm, press "EXIT" back to standby.

RxTxLED (RxTxLED • MENU 18)

The feature allows you to select if the blue LED lights ON when receiving a signal and red LED light comes on while transmitting. User may turn OFF the LED lights during Rx or TX. Default selection is "ON".

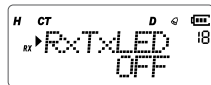

Press "MENU" then rotate the top selector knob to select "Menu 18". Right after, press the "MENU" button and rotate the top selector knob to select (ON or OFF). After making a selection press "MENU" again to confirm selection and exit the menu.

34

FM Radio (FM Radio • MENU 19)

Press "MENU", then rotate the top selector knob to select "Menu 19", screen displays:

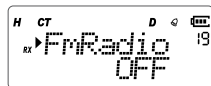

Next, press "MENU", arrow points "ON" place, press ▲ / ▼ to select ON to turn on this function or select "OFF" to this function OFF, press "MENU" to confirm, press "EXIT" to return to standby.

FM Radio (FM Mon • MENU 20)

Turns on the FM Radio receiver. The FM frequency is shown on the display with the previous master frequency of the radio in standby priority channel and is watched continuously. If a carrier is detected on the master frequency the radio switches to that frequency and only reverts back to the FM Radio after 3 seconds of no signal.

OFF: Radio is only working in the frequency currently displayed.

Press "MENU", then rotate the top selector knob to select "Menu 20", screen displays:

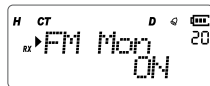

Then, press "MENU", arrow points "ON", press ▲ / ▼ to select one of ON / OFF, press "MENU" to confirm, press "EXIT" back to standby.



Timer Set (Timer • MENU 21)

Press "MENU", then rotate the top selector knob to select "Menu 21", screen displays:

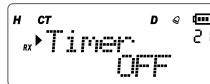

Right after, press "MENU", arrow points "ON", press ▲ / ▼ to select ON to turn on this function or select "OFF" to turn this function OFF, press "MENU" to confirm, press "EXIT" to return to standby. Press # to start/stop timer. Press "EXIT" to clear timer. Press "EXIT" two times to cancel timer and return to normal operation.

Single / Dual Display Mode (SubDisp • MENU 22)

Press "MENU", then rotate the top selector knob to select "Menu 22", screen displays:

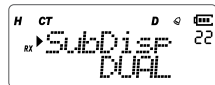

At that instant, press "MENU", arrow points "DUAL", press ▲ / ▼ to select single receive mode (only show 1 frequency), or dual receive mode (show two frequencies), press "MENU" to confirm, press "EXIT" back to standby.

36

Single Display / Battery Voltage (SgIDisp • MENU 23)

The feature allows user to select if they want Battery Voltage displayed or Blank when operating in the Single Display mode.

Operating in the single display mode will greatly extend the radio's battery life and operation time between recharging. Default selection is "VOLTAGE".

Press "MENU" then rotate the top selector knob to select "Menu 23". Right after, press the "MENU" button and rotate the top selector knob the select (VOLTAGE or BLANK).

After making a selection press "MENU" again to confirm selection and exit the menu.

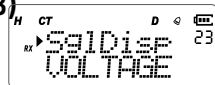

Transmit Time Out Timer (TOT • MENU 24)

Purpose of TOT function is to stop the radio's transmit after a pre-set amount of time. Settable range of emission limit is 30~300 sec. Default TOT timer is set to 120 seconds.

Press "MENU", then rotate the top selector knob to select "Menu 24", screen displays:

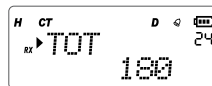

At that instant, press "MENU", arrow points "OFF", press ▲ / ▼ to select OFF to turn off TOT or TOT level you need, press "MENU" to confirm, press "EXIT" back to standby.

Busy Channel Lock Out (BCLO • MENU 25)

OFF: turn off the function; WAVE: carrier lock, prohibit transmitting when receives signal; QT \ DQT: prohibit transmitting if anti-interference code is wrong, QT \ DQT menu item is only displayed when anti-interference code function is available.

Press "MENU", then rotate the top selector knob to select "Menu 25", screen displays:

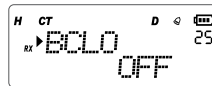

Then, press "MENU", arrow points "OFF", press ▲ / ▼ to select one of OFF / WAVE mode, press "MENU" to confirm, press "EXIT" back to standby.

Squelch Mode (Sql Mode • MENU 26)

The feature allows user to select the master squelch mode by selecting ("1" "2" or "3"). Selection "1" will generally have the loosest squelch setting which allows the weakest signals. Selecting "2" will tighten the overall squelch and selecting "3" will only allow the stronger signals to come through your handhelds speaker. Default selection is "2".

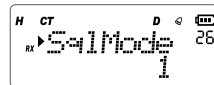

Press "MENU" then rotate the top selector knob to select "Menu 26". Right after, press the "MENU" button and rotate the top selector knob the select ("1" "2" or "3"). After making a selection press "MENU" again to confirm selection and exit the menu.

38

Squelch-Tail Eliminate (Sql Tail • MENU 27)

Press "MENU", then rotate the top selector knob to select "Menu 27", screen displays:

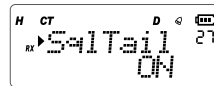

Then, press "MENU", arrow points "ON", press ▲ / ▼ to select ON to turn on this function or select "OFF" to this function OFF, press "MENU" to confirm, press "EXIT" to return to standby.

Power Save (PwrSave • MENU 28)

Press "MENU", then rotate the top selector knob to select "Menu 28", screen displays:



At that instant, press "MENU", arrow points "AUTO", press ▲ / ▼ to select one of AUTO smart save / simple ordinary save / OFF mode, press "MENU" to confirm, press "EXIT" back to standby. Default is "OFF".

VOX Control (VOX • MENU 29)

Press "MENU", then rotate the top selector knob to select "Menu 29", screen displays:

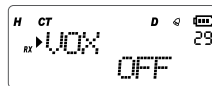

Soon after, press "MENU", arrow points "OFF", press ▲ / ▼ to select OFF to close VOX or select level 1~9 to turn on VOX level, press "MENU" to confirm, press "EXIT" to return back to standby.

VOX Delay (VOX Del • MENU 30)

Settable Range of VOX delay is 0.3~5.0 sec, long-press UP / DOWN key for 2 sec go into quick-select mode.

Press "MENU", then rotate the top selector knob to select "Menu 30", screen displays:

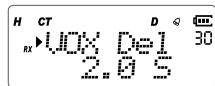

Next, press "MENU", arrow points "2.0S", press ▲ / ▼ to select delay time, press "MENU" to confirm selection, press "EXIT" back to standby.

40

Edit & Save Channel Name (Ch Name • MENU 31)

User can edit name of saved channel. This function is unavailable in frequency mode.

Press "MENU", then rotate the top selector knob to select "Menu 31", screen displays:



Then, press "MENU", arrow points down and character position starts to blink. Press ▲ / ▼ to select character ("0~9"; "A~Z"; "-"), then press "*" to move left, press "#" to move right, press "MENU" to confirm selection, press "EXIT" back to standby.

Memory Channel Store (Save Ch • MENU 32)

Save current frequency into selected channel. User can input channel number by keyboard. In frequency mode, it only saves transmitting frequency if exists the same frequency with one you selected, receive frequency does not change. In non-frequency mode, transmitting and receive frequency will be saved into selected channel.

Press "MENU", then rotate the top selector knob to select "Menu 32", the screen displays:



Right after, press "MENU", arrow points to "CH-001"; press ▲ / ▼ to select the channel you want to save, press "MENU" to confirm, press "EXIT" back to standby.



Memory Channel Delete (Del Ch • MENU 33)

Channel list only displays already existing channel. This function is unavailable in frequency mode. Press "MENU", then rotate the top selector knob to select "Menu 33", screen displays:

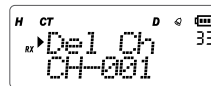

Next, press "MENU", arrow points to "CH-001"; press ▲ / ▼ to select the channel you want to delete, press "MENU" to confirm, press "EXIT" back to standby.

Reset

Turn off the radio, press "EXIT" key and then turn on the radio, upper line on the screen shows "RESET?", lower line shows "VFO". Press "MENU", to make a choice by pressing key or step control ▲ / ▼ key. Press "MENU" again to confirm until the lower line on the screen shows "ALL", then the lower line will display "WAIT", now it begins to clear all settings and channel memories, default settings from factory. The radio will enter factory MR mode automatically after all settings are cleared up.

42

Reverse Frequency Function

MR mode/ VFO mode, long press "*" key for two seconds a symbol "R" will appear on the top of the screen, which means reverse function is on. Long press "*" again for another two seconds, "R" will disappear. Tx and Rx frequency as well as CTCSS/CDCSS will exchange when reverse frequency function is on.

Main Band Operation A/B Switch

MR mode/ VFO mode, press "EXIT" key will switch between top and bottom display. A triangle symbol "▲" and "▼" will appear on top of the screen, which represents current frequency.

VFO or Memory Channel Mode

Press "*" key to switch between VFO and MR mode, and Channel Name mode. MR+VFO mode and Channel Name mode can be accessible, only if at least there is one channel has been stored into a memory. In VFO mode, the frequency can be entered. Press "EXIT" key to delete the previous figure. In MR mode, use the keyboard to input pre-set operation frequency. In Channel Name mode, if there is no such option as setting channel name then the screen will display "CH-N". N stands for the current channel.



◆ Wired Clone

1. Turn clone function by programming software or contact your local dealer.
2. Connect source radio and target radio with clone cable, and turn target radio on.
3. Hold down [Side Key] on Source Radio, then power it up. About 3 seconds later, the LED glows red, which means the Source Radio is ready for cloning.
4. Press [Side Key] on Source Radio again, and the LED on Source Radio flashes red and LED on Target Radio flashes green. The LED on Target Radio goes out when the cloning is finished.
5. Replace the Target Radio with another, then press [Side Key] on Source Radio to begin cloning.

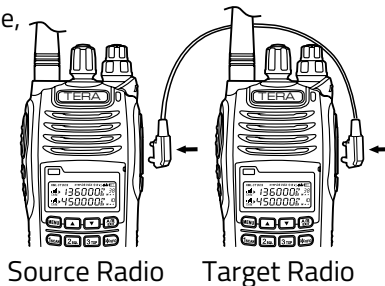

Tip

» If the LEDs on both Source Radio and Target Radio flashes red and green alternatively, it means the cloning has failed.

◆ Troubleshooting

Please check the radio with the troubleshooting chart below to correct any issues.

Fault	Possible Causes	Solution
Radio will not turn ON	<ol style="list-style-type: none">1. Battery is not installed correctly2. Battery power is exhausted3. Battery aging	<ol style="list-style-type: none">1. Install the battery again2. Charge battery for two hours3. Purchase a new battery
Receiving light remains on, but the speaker is silent	<ol style="list-style-type: none">1. Volume switch is turned down2. CTCSS enc/decode wrong	<ol style="list-style-type: none">1. Check and adjust volume2. Ensure you use the correct mute method3. Ensure you have the correct CTCSS/CDCSS tone in use or turned off
No audio from radio speaker	<ol style="list-style-type: none">1. Tighten the antenna2. The local radio FM signal is too weak	<ol style="list-style-type: none">1. Screw antenna down until snug2. Move to place where radio signal is strong3. Press ▲ key to reset radio, then press ▼ key to select the radio frequency

Keypad and the PTT key is unresponsive	<ol style="list-style-type: none">1. The lock function could be turned on2. You could be in FM radio mode	<ol style="list-style-type: none">1. Unlock keypad2. If display indicates "FM", then exit FM radio mode
Receiving light remains on, and you can't transmit	<ol style="list-style-type: none">1. BCLO could be turned on	<ol style="list-style-type: none">1. Turn off BCLO
You can't save a setting	<ol style="list-style-type: none">1. You might be in channel mode	<ol style="list-style-type: none">1. Change to frequency mode
Radio is transmitting while no one is talking	<ol style="list-style-type: none">1. VOX level is set to low (too sensitive)	<ol style="list-style-type: none">1. Turn VOX off, or set it to a higher level
Receive voice or interferences	<ol style="list-style-type: none">1. You may set a wrong frequency2. Others on that frequency use the same CTCSS/CDCSS tone	<ol style="list-style-type: none">1. Double check your frequency, change to a different one, if needed2. Choose a different CTCSS/ CDCSS tone

◆ Specification

Frequency Range	VHF: 136 ~ 174 MHz (Rx/Tx)
	UHF: 400 ~ 470MHz (Rx/Tx)
Channel Number	199 Channels
Voltage	DC 6.6V ~ 8.4V
Temperature Range	-25°C ~ 55°C
Operation	Single or Dual Receive
Output Power	VHF: 5/3/.5W; UHF: 5/2/.5W
Modulation	Wide / Narrow Band
Max. Deviation	≤±5 KHz for Wide Band ≤±2.5 KHz for Narrow Band

Residual Wave Transmit	≤-36 dB
Frequency Stability	±2.5 PPM
Receiving Sensitivity	0.2 μV (≥18dB)
Max. Audio Power	≥700mW
Weight	237g
Dimension	124x62x36 mm



Note

» Without notice, specification are subject to change, according to technological improvements.



TERA

◆Optional Accessories



Ext Gain Antenna



USB Programming Cable

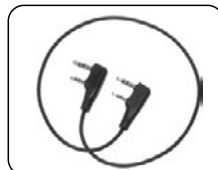

Cloning Cable



Stubby Antenna

◆ Service and Support

TERA Radio provides warranty and non-warranty support for this radio and accessories.

Warranty and Repair Services

1. TERA two-way radio body has an industry leading 2-year warranty. Radio accessories (battery, charge adapter, charger and antenna, speaker mics) include a 6 month warranty from date of purchase.
2. The radio warranty of 2-years is in effect from the original purchase date on the sales receipt or invoice.
3. Repair or Replacement is available provided the original purchaser's sales receipt copy is included when the radio or accessories are sent in for repairs.
4. Replacement and repair of radios and accessories is provided at the discretion of TERA radio
5. All repaired parts have its own warranty of 90-days from the repair date or the original radio warranty depending on the longer one is valid.

6. The warranty is only valid using this radio for normal use. And guaranty is unavailable under such conditions: dissembling or modifications, damages caused by outside force, water or moisture and usage of unapproved accessories or antenna, not according to the instruction manual and so on.
7. Warranty is void if the TERA label or Serial Number label is missing or torn off.

Caution

1. Read the user manual before use the radio.
2. Do not use the radio with damaged antenna. Use the radio only with standard antenna.
3. Turn off the radio in potential dangerous environment.
4. Avoid the contact between battery and metal objects, oily objects or corrosive objects.
5. Do not dip the radio or battery into water or throw them in fire.
6. Use the radio only with standard battery, adapter, charger and earphone.



Terms of Warranty

1. TERA two-way radio body has an 2-year guarantee; accessories (battery, charge adapter, charger and antenna), earphone 6 months.
2. Only the original purchasing sales receipt or valid dealer's invoice (The invoice will give clear indication of items purchased and the radio serial-number, and purchasing date).
3. Replacement and repair is available subject to the presentation of original purchasing invoice in case that the radio cannot work normally as the instruction says within 30 days from the purchase date. (Note that there must not be visible abrasion on radio body and accessories).
4. Repair of accessories (battery, adapter, charger and antenna) is available to the presentation of original purchasing invoice.
5. The cost of materials and labor for repair are covered in warranty.
6. Warranty is void in case that the TERA mark or the serial-number mark is torn off.
7. Warranty is void in cases below:
 - 1) Beyond the warranty period;
 - 2) Defects or damages under abnormal use;
 - 3) Defects or damages because of mis-operation, accident, water penetration

and carelessness;

- 4) Defects or damages because of incorrect testing, operation, repair, installation, reconfiguration or adjustment;
- 5) Defects or damages to antenna because of non-material or non-processing problems;
- 6) Defects or damages because of unauthorized repair and disassembling;
- 7) Product that the serial-number marks is torn off or unable to identify;
- 8) Product with unclear purchasing date on original sales receipt.
- 9) Battery under such conditions:
 - a. Any damages or unsealing to the battery pack;
 - b. Defects or damages to battery because of charging with improper equipment or use beyond regulated maintain condition;
- 10) Abrasion under normal use.

Warning Notes

Every effort has been made to ensure that the information in this document is complete, accurate, and up to-date. TERA Radio assumes no responsibility for the results of errors beyond its control. The manufacturer of this equipment also cannot guarantee that changes in the equipment made by non-authorized users will not affect the information in it.



FCC Licensing Information

This TERA radio operates on Commercial / Land Mobile frequencies which require a license from the Federal Communications Commission (FCC) for business, personal, education and recreational use. To obtain forms, call the FCC forms hotline at:

1-800-418-3676 or go to <http://www.fcc.gov>.

For questions concerning commercial licensing, contact the FCC at 1-888-CALL-FCC (1-888-225-5322).

Safety

The TERA TR-590 handheld transceiver has been carefully designed to provide you with years of safe, reliable operation. As with all electrical equipment, however, there are a few basic precautions you should take to avoid hurting yourself or damaging the radio:

- Read the instructions in this handbook carefully. Be sure to save it for future reference.
- Read and follow all warning and instruction labels on the radio and owner's manual.
- Do not carry the transceiver by the antenna. This may damage the antenna or antenna terminal. Grasp the handheld by its base (not the antenna) when you need to place or remove it.
- Do not keep the radio with the antenna very close to, or touching exposed parts of the body, while transmitting. TERA radios will perform best, if you speak 2-4 inches away from the microphone and the radio is vertical.
- Be sure the "PTT" key is not pressed when you do not need to transmit.
- Do not operate the radio near unshielded electrical blasting caps or in an explosive atmosphere.
- Do not transmit without the antenna fitted on the radio. Though it is provided with a protection, it may damage the TX output final stage.



- Respect the environment conditions. The radio is designed to be used in heavy environments, however avoid exposing it to extremely hot or cold temperature (out of the range between -20 to $+140^{\circ}\text{F}$). Do not expose the transceiver to excessive vibrations as well as dusty or rainy locations.
- Never try to disassemble or service the radio by yourself (aside from the routine maintenance described in this handbook). It may cause damage to the radio transceiver and void your warranty requiring extensive repair work. Always contact your local dealer for assistance.
- Use only authorized accessories. Using non TERA radio brand accessories may seriously damage your handheld transceiver and void your warranty.
- Do Not spill liquid of any kind into your radio. If the transceiver gets wet, immediately dry it by a soft and clean cloth.
- Switch the radio off before you clean it. Follow the directions described in the paragraph "Care and maintenance".
- Handle the battery properly. Never place the LI-ion battery in your pocket or purse with loose coins. This could result in short circuiting the battery.
- Be certain that your power source matches the rating listed for the supplied battery charger (AC adapter). If you are not sure, check with your authorized TERA dealer.

- Avoid damaging the power cable of the battery charger. Do not step on or place anything on it as this could result in a damaged charger power cord. This product complies with the requirements of the Council Directives 89/336/EEC and 73/23/EEC on the approximation of the laws of the member states relating to electromagnetic compatibility and low voltage.

WARNING

Your wireless hand-held portable transceiver contains a low power transmitter. When the Push-to-Talk (PTT) button is pressed it sends out radio frequency (RF) signals. The device is authorized to operate at a duty factor not to exceed 50% TX and 50% RX. In August 1996, the Federal Communications Commission (FCC) adopted RF exposure guidelines with safety levels for hand-held wireless devices. To maintain compliance with the FCC's RF exposure guidelines, this transmitter and its antenna must maintain a separation distance of least 2 inches from your face. Speak in a normal voice, with the antenna pointed up and away from the face at the required separation distance. The belt clip is for storage purposes only. **AVOID TRANSMITTING ON HIGH POWER WHILE RADIO IS ATTACHED TO YOUR BELT.** To transmit, hold the device away from your body and ensure the antenna is at least 2 inches from your body when transmitting.



