

# Haier®

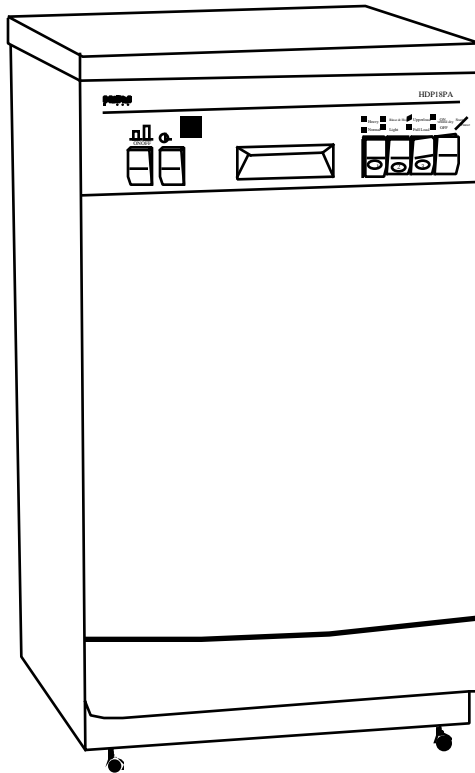

*What The World Comes Home To™*



Portable  
Dishwasher

*User Manual-*

*Model #*

**HDP18PA**

# IMPORTANT SAFETY INSTRUCTIONS

**Warning – To reduce the risk of fire, electric shock, or injury to persons when using your appliance, follow basic precautions, including the following:**

1. **Read all instructions before using the appliance.**
2. Use this appliance only for its intended purpose as described in this use and care guide.
3. Use only detergents recommended for use in this appliance and keep them out of the reach of children.
4. This appliance must be properly installed in accordance with the installation instructions before it is used.
5. Never unplug your appliance by pulling on the power cord. Always grasp the plug firmly and pull straight out from the outlet.
6. Replace immediately worn power cords, loose plugs/power outlets.
7. Unplug your appliance before cleaning or before making any repairs.
8. Do not open the dishwasher door immediately after completion of wash process or during the operation as hot air/steam may cause personal injury. Press the door latch, wait few seconds by allowing cold air to go in and then open the door.
9. Do not operate your appliance in the presence of explosive fumes.
10. Do not add or mix any flammable or explosive substances to the wash.
11. Appliance loading door must be closed during the operation of the machine.
12. Do not operate your appliance when parts are missing or parts are broken.
13. Do not use this appliance for commercial dishwashing purpose.
14. Do not operate this appliance unless all enclosure panels are properly in place.
15. Do not tamper with controls.
16. To reduce risk of injury do not allow children to play in or on the appliance. Close supervision of children is necessary when the appliance is used near children.
17. This appliance must be connected to proper electrical outlet with the correct electrical supply.
18. Proper grounding must be ensured to reduce the risk of shock and fire. **DO NOT CUT OR REMOVE THE GROUNDING PLUG.** If you do not have a three-prong electric receptacle outlet in the wall, have a certified electrician install the proper receptacle. The wall receptacle **MUST** be properly grounded.
19. Hydrogen gas may be produced if the water heater has not been used in more

then 2 weeks. This could be explosive and can explode under certain circumstances. If this is the case, before using this appliance turn on all the hot faucets and let the hot water run for a few minutes. This will let the trapped hydrogen escape. During this process do not turn on an electric appliance, smoke, light a match/lighter or use a flame to avoid an accident, as hydrogen gas is flammable and can explode.

- 20. Do not repair or replace any part of the appliance or attempt any servicing unless specifically recommended in the user-repair instructions that you understand and have skills to carry out.
- 21. To reduce the risk of electric shock or fire, do not use extension cords or adapters to connect the unit to electrical power source.
- 22. Do not go behind the dishwasher during the operation because of hot steam that is being discharged from the back vent.
- 23. Do not wash any heat sensitive or any other items that are not designed for automatic dishwasher.
- 24. Do not use this dishwasher outdoors.
- 25. Do not leave the dishwasher door open to dry dishware while children are around. Close supervision and observation needed when children are around the dishwasher.
- 26. Do not abuse, sit on or stand on the door or dish rack of the dishwasher.
- 27. Do not touch the heating element immediately after use, as it may be very hot.
- 28. Load sharp objects such as knives and forks upside down to reduce the risk of injury.

## SAVE THESE INSTRUCTIONS

Thank you for purchasing our Haier product. This easy-to-use manual will guide you in getting the best use of your dishwasher.

\_\_\_\_\_ *Model number*

Remember to record the model and serial number. They are on a label in back of the dishwasher.

\_\_\_\_\_ *Serial number*

\_\_\_\_\_ *Date of purchase*

Staple your receipt to your manual. **You will need it to obtain warranty service.**

# Table Of Contents

	PAGE
<b>SAFETY INSTRUCTIONS</b> .....	<b>1</b>
<b>OPERATING INSTRUCTIONS</b> .....	<b>4</b>
Parts and Features.....	4
Operations .....	7
Tips to Avoid Stains and Films .....	14
<b>Care and Cleaning Guide</b> .....	<b>20</b>
General Cleaning and Maintenance.....	20
Preventing Your Dishwasher From Freezing.....	21
Storage of your Dishwasher in Cold Environment .....	21
<b>Troubleshooting</b> .....	<b>22</b>
<b>INSTALLATION INSTRUCTIONS</b> .....	<b>26</b>
Tools and Materials Required.....	26
Unpacking Your Dishwasher .....	26
Steps for Installation .....	27
Installing Quick Connect Sink Adapter .....	28
<b>Electrical Connections</b> .....	<b>29</b>
Grounding Instructions.....	29
Power Interruptions .....	29
<b>Warranty</b> .....	<b>30</b>

# OPERATING INSTRUCTIONS

## Parts and Features

(Front view with Open Door)

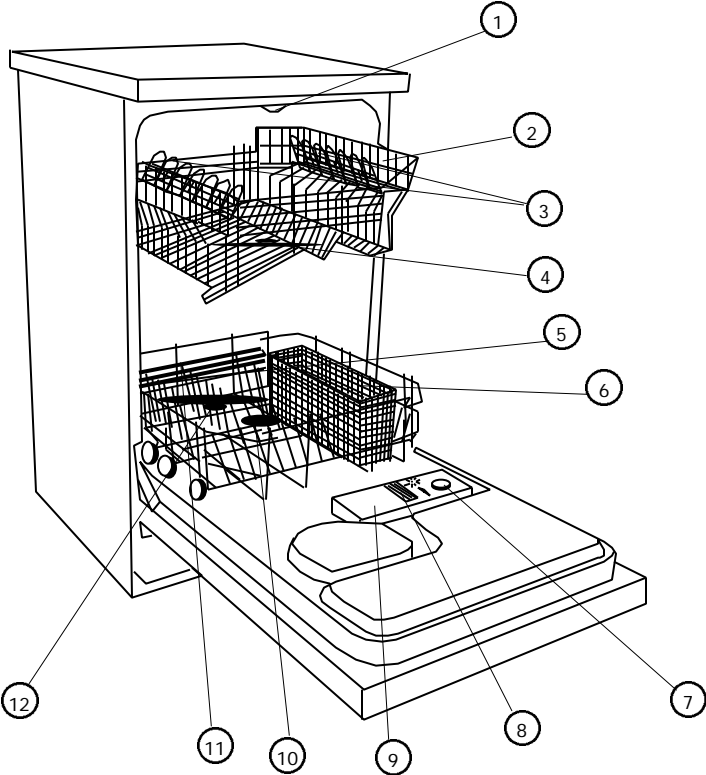

- 1. Upper Sprayer
- 2. Upper Rack
- 3. 2 Full Length Folding Racks
- 4. Middle Spray Arm
- 5. Lower Rack
- 6. Silverware Basket
- 7. Rinse Aid Compartment
- 8. Pre-wash Detergent Compartment
- 9. Main Wash Detergent Compartment
- 10. Triple Level Filtration System (Located at the bottom under Lower Rack)
- 11. Heating Element
- 12. Lower Spray Arm

(Front view with Door Closed)

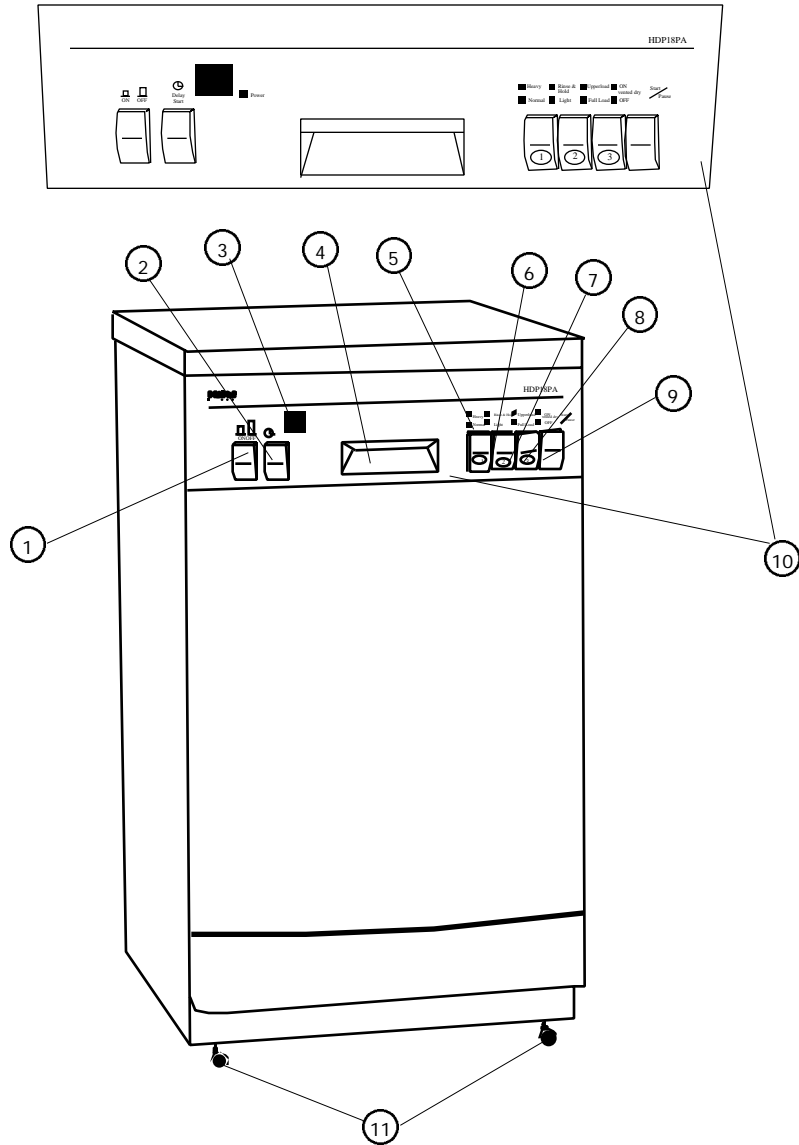

- |                                   |                                 |
|-----------------------------------|---------------------------------|
| 1. On/Off Button                  | 7. Load Selector Button (2)     |
| 2. Delay Start Button             | 8. Vented Dry Option Button (3) |
| 3. Delay Timer Display (HRS)      | 9. Start/Pause Button           |
| 4. Door Latch                     | 10. Control Panel               |
| 5. Function Indicator Lights      | 11. Casters                     |
| 6. Wash Cycle Selector Button (1) |                                 |

(Rear View)

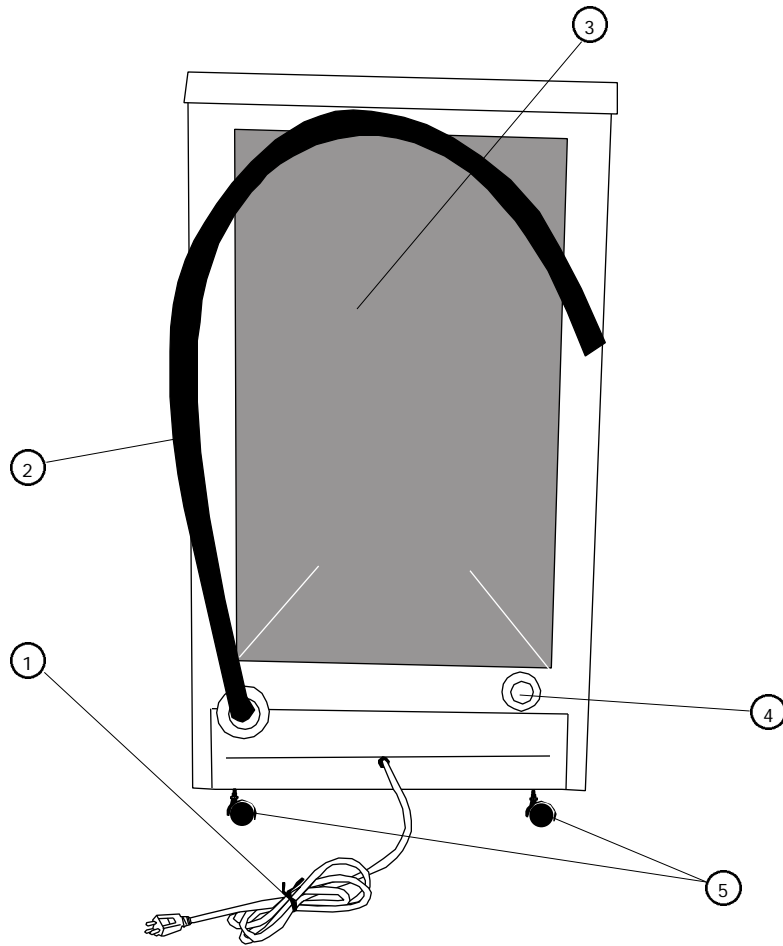

- 1. Power Cord (115 Volt / 60 Hz)
- 2. Drain Hose (attached)
- 3. Rear Insulation Panel
- 4. Water Inlet
- 5. Rear Casters

## OPERATIONS

### Understanding the Control Panel:

#### Power Button:

- Push this button to have power On/Off. Once the power is on, the power indicator light will go "On".



**Note:** When you turn the power "On", the function indicator light will be displayed at "Normal" wash cycle, "Full Load" and "Vented Dry" (off option).

#### Delay Start Button:

- Press this button to delay the starting time for a wash cycle. You can delay the starting time for a wash cycle between 1 to 9 hours.



#### Timer Display:

- This display shows number of hours you set the timer to delay the starting time for a wash cycle.



#### Door Latch:

- To lock the door, push the door with light force until you hear the "Click". To unlock the door, squeeze the door latch and pull towards you.

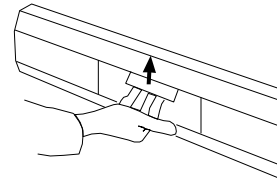

**Warning:** You must wait few seconds when opening dishwasher door during a cycle to allow outside cold air to expand slowly inside the dishwasher because of hot air/steam is still present inside the dishwasher. If you try to remove items right a way after you open a door, the hot air/steam may cause personal injury.

**Note:** You must keep the door closed during the dishwasher operation in order to avoid any water leak.

#### Wash Cycle Selector Button ① :

- Press this button to select Heavy, Normal, Rinse & Hold and Light wash cycle options. The function indicator light will come on once you are in that option. (See page # 14 for more detail under "Selecting Wash Cycle" section)

- Heavy ■ Rinse & Hold
- Normal ■ Light





**Upper Load or Full Load Option Button ② :**

- Press this button to select Upper Load or Full Load option. The light indicator will come on once you are in that option. (See page # 14 for more detail under "Wash Cycle Options" section.)

- Upper Load
- Full Load

**Vented Dry Option Button ③ :**

- Press this button only if you want to select Vented Dry option to dry your dishware. The heating element is activated to heat up the air in order to dry your dishware when this option is selected. The light indicator will come on when you select this option. (See page # 15 for more detail under "Wash Cycle Options" section.)

- Vented Dry

**Start/Pause Button ④ :**

- Press this button to select Start or Pause option. Press this button once to start the wash cycle. Press this button once again to pause the activity during the cycle.
- The "Pause" function allows you to add or remove dishware during the cycle operation.

- Start / Pause

**Wash Cycle Indicator Light:**

- When the wash cycle is selected, the light comes on and blinks indicating that washing process has begun. At the end of the wash cycle, the buzzer will beep indicating that wash cycle is completed and the machine will shut off automatically.

- Heavy    ■ Rinse & Hold
- Normal   □ Light

**Open Door Protection:**

- Your dishwasher will stop automatically if the door is opened during the operation. The function indicator light will flash and buzzer will beep. The machine will not restart until the door is closed again.

**Warning:** The dishwasher door must be closed at all times during the operation.

### Automatic Fault Alarm:

- Your machine is equipped with automatic fault detection system. This convenience feature informs you of any faults during the operation. When fault occurs, the function indicator light will flash and the buzzer will beep.

### Preparing to wash dishes:

To get best results, practice the following before you put dishware in the dishwasher:

- Discard big chunks of food such as bones and pits from the plate before loading.
- Remove sticky foods and loosened burned-on foods before loading.
- Empty liquids such as juice, soup, soda, coffee or tea from glasses and cups before loading.
- Rinse off acid based liquid, such as vinegar or lemon juice right a way. This may cause discoloration over time to your plates, food containers or internal cabinet.
- Always check manufacturer's recommendations before you start washing items.

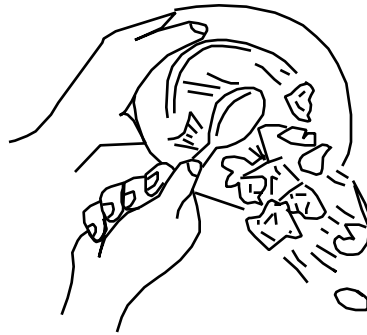

**Loading the Lower & Upper rack:**

To get maximum cleaning result, follow the recommendations below before you start the dishwasher:

**Note:** Do not wash any heat sensitive or any other items that are not designed for automatic dishwasher.

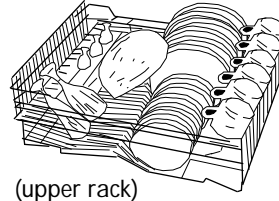

- Keep all tall dishware and food containers away from the spray arm rotation.
- Place food containers such as cups, glasses, bowls, saucepans and casseroles with soiled surface facing in downward position.

- To avoid any type of damage to glassware such as coffee/tea cups, beverage, wine and champagne glasses, do not load them on the bottom rack. Place these items on the upper rack.

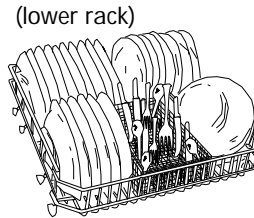

- Put cups upside down on the top of cup/stemware rack and put wine or champagne glasses upside down between the divided segments of the cup/stemware rack to secure them properly.

**Note:** Do not wash dinner plates bigger than 10 1/4" diameter.

**Loading Silverware Basket:**

Simply remove the basket out of the dishwasher to load silverware and place it back once you finish loading.

- To avoid any type of injury, load knives and forks face down.
- Try to mix spoons, knives and forks for better cleaning and drying and to prevent nesting.
- Do not mix stainless steel and silver items because you may damage silver finish on silver items.
- Do not load tall items next to upper spray arm because it could be blocked.
- Do not load dishware or food containers that are made of wood or iron. These items are not considered dishwasher safe.
- Do not load tin, pewter and non-dishware filters. These items are not considered dishwasher safe.

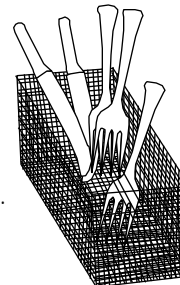

**Proper Use of Detergent:**

- The amount of detergent to use depends on the type of water in your living area whether it is hard or soft and whether items are lightly or heavily soiled.
- Water softness or hardness is measured in grains content per gallon. You can find out grains level by calling your local Environmental Protection Agency (EPA) in your county.
- If you find that "grains" level is higher in the water then the water will be harder in your living area so you will need more detergent to clean. If "grains" level is lower then the water will be softer in your living area so you will need less detergent to clean.

See the following table to understand the "water hardness type" and "grains" level.

Water Hardness Type	Level of Grains in the water
Hard	10+
Medium	4-9
Soft	0-3

**Note:** If "grains" level is over 12 then water is very hard. You may need water softener to improve the water quality and the performance of your dishwashing.

**Note:** The quality of detergent will make the big difference of cleaning your dishes. If you are using detergent that is damp, clumsy or too old then this type of detergent will not be as effective to clean because of active ingredients are phased off and the detergent will not work properly.

**Note:** Use only manufacturer's recommended "Automatic Dishwasher Detergent" only for your dishwasher. Other types of detergents that are not for dishwasher use may cause oversudsing and foaming. Do not use detergents that are dried, caked or moist. These types of detergents will not dissolve properly and clean effectively.

**Pouring Dishwasher Detergent:**

Use proper recommended amount of detergent for your wash loads. Measure and pour detergent into the large compartment for the main wash. The detergent for pre-wash goes into the small compartment next to the main wash compartment.

**Note:** For the pre-wash you should use one-half the amount of detergent that you use for the main wash.

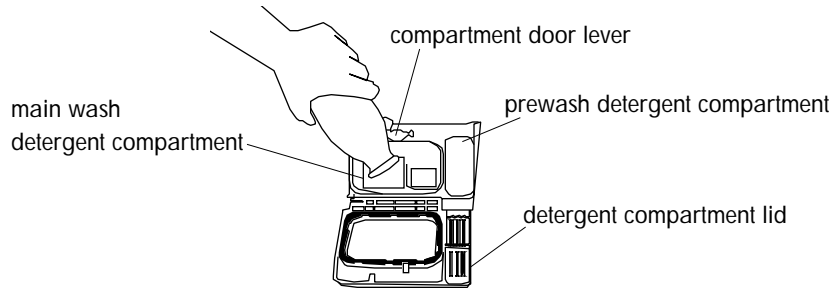

**Advantages of Rinse Agent:**

Rinse agent helps in removing spots and prevents new film build-up on your dishes, glasses, flatware, cookware and plastic.

**Note:** Use only liquid form of rinse agent in the dispenser.

**Pouring Liquid Rinse Aid into the Dispenser:**

Use proper recommended amount of rinse aid for your wash loads. The rinse aid dispenser is located next to the detergent dispenser. During the wash cycle, it automatically releases a preset amount of rinse aid during the last rinse cycle.

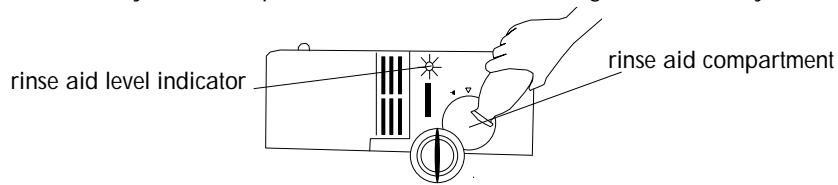

When the dispenser is full, the see through rinse aid level indicator will be dark. When it is empty, it will be clear which means you need to pour in more.

- Fu
- 3/4 Fu
- 1/2 Fu
- 1/4 Fu
- Emp

**Note:** A full dispenser should last approximately one month.

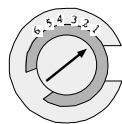

If you want to adjust the amount of rinse aid dispensed, the dispenser has 1 to 6 levels that you can adjust to. Simply rotate the dial to your desire settings.

**Tips:**

- Always start with level "1".
- Set on level "2" if spots appear on your dishware.
- If dishware are not drying properly or spotted, adjust to the next higher level until they are spotless.

As the rinse aid level become less, the size of the see through level indicator changes, as shown below.

Fu Full  
3/4 Fu 3/4 Full  
1/2 Fu 1/2 Full  
1/4 Fu 1/4 Full – At this time you should refill to eliminate spotting  
Emp Empty

To add liquid rinse aid dispenser, follow the procedure below.

- 1) To open, turn the dispenser cap to a clear triangle symbol ▼ and lift up.
- 2) Pour in rinse aid until liquid touches the indicated fill level.  
**Note:** Do not overfill and spill because it will cause overflow and foaming.
- 3) Once you finish pouring, replace the cap back by turning it to a dark triangle symbol ▼.
- 4) To avoid oversudsing, wipe off any spills with damp cloth.

**Warning: Dishwasher detergent is harmful!**

**You must keep it in a safe place out of the children reach.**

**Check List for Wash Process:**

1. Make sure all items are loaded in the racks properly.
2. Pour in proper detergent into the detergent dispenser.
3. Close the door and latch safely.
4. Select the desired wash cycle and options.
5. Press "Start" button to start the wash process.
6. Select "Vented Dry" button if you want to dry after the wash cycle is finished.

**Note:** To add or remove items after cycle starts, press the pause button and unlock the door latch and wait a few seconds until wash action has stopped. Open the door and let hot steam inside the dishwasher out. After the hot steam is completely released, you can now add or change items. Once you make your changes, close the door gently, lock the door latch and press "Start" button to resume the cycle.

**Selecting Wash Cycle:**

For your convenience, your dishwasher has four options to select from: Normal, Heavy, Light and Rinse & Hold option. Press Button 1 to select proper wash cycle option based on the soil content on your dishware.

- Heavy    ■ Rinse & Hold
- Normal    ■ Light

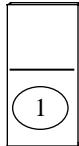

**Normal Wash Cycle:**

- This is used for regular loads for medium soiled dishware, silverware and glassware.

**Heavy Wash Cycle:**

- This cycle is used for heavily soiled dishware, glassware, silverware, pots & pans and cookware with dried soils.

**Light Wash Cycle:**

- This cycle is used for lightly soiled or pre-rinsed dishes and silverware.

**Rinse & Hold Cycle:**

- This cycle is used for rinsing partial loads that will be washed later.

**Wash Cycle Options:**

- When washing your dishware, you can select Upper Load/Full Load, Vented Dry and Delay Start options.

**Upper Load or Full Load Option:**

- Press Button 2 to select the proper load option depending upon the load size.

**Upper Load Option:**

- You can select this option when you want to wash small numbers of dishware or glassware. You can place them on the upper rack and select "Upper" load option on the control panel.

- Upper Load
- Full Load

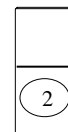

**Note:** The lower rack must be empty when using "Upper" load option. You must use one-half the amount of detergent than you would normally use for full load option.

### UNDERSTANDING DISHWASHING TIME

Standard Wash Time		Wash Time with Vented Dry Option	
Cycle Type	Approx. Time	Cycle Type	Approx. Time
Heavy	60 Minutes	Heavy	75 Minutes
Normal	45 Minutes	Normal	60 Minutes
Light	40 Minutes	Light	55 Minutes
Rinse & Hold	10 Minutes		

#### Vented Dry Option:

Press Button 3 to select vented dry option.

- You can select this option at the beginning of the wash cycle to dry your dishware items. Press the button in to have vented dry option "On" or press the button out to have vented dry option "Off".

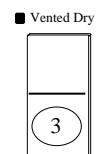

**Note:** When selecting any of the above cycles or options, you will see the following:

- It will take approximately 60 seconds to begin the wash cycle.
- In wash mode, light comes on and blinks indicating that wash cycle is selected
- At the end of the cycle, machine will beep indicating that wash cycle is completed and shut off automatically.

**Warning:** When you leave the door open to air dry those washed items, make sure there are no children around to go near the dishwasher to climb over. If there are children around near the dishwasher, pay careful attention and observation toward children.

- When this option is selected, the heating element is activated to heat up the air in order to dry dishware.

**Note:** If you want to avoid heat dry, keep the dishwasher door slightly open to release the moist air, this way you can speed up the drying process.

**Warning:** Keep children away from the machine when the door is open to dry because of the hot air is exiting out of the dishwasher.



### Understanding the Venting Process:

- In this process, the hot steam from the dishwasher is being drawn into the drain pump through its vacuum force and the mix condensation of water and air is being discharged through the discharge hose from the back of the unit.

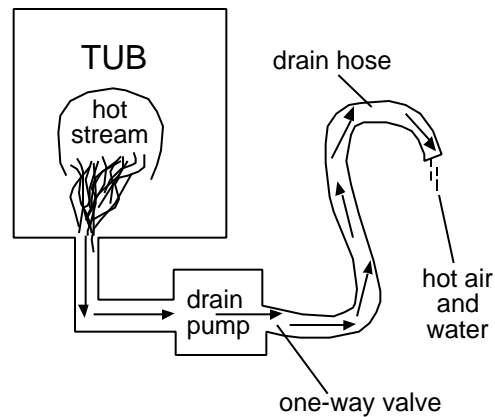

### Delay Start Option:

Press "Delay Start" button to delay the starting time for a wash cycle. You can delay the starting time for a wash cycle between 1 to 9 hours. The machine will count down and start automatically at the pre-set time.

Follow the steps below to delay start:

1. Press the "Delay Start" Button to select between 1-9 hours.
2. Once you have set the hours to Delay Start, select the proper wash cycle and your options. Press the Start button to activate the process. The light of selected cycles and options will blink.
3. Close the door properly by making sure that door latch is locked.
4. The wash cycle will start automatically at the appropriate time.
5. To cancel, press On/Off button, wait approximately 30 seconds and reset.

**Checking Water Temperature:**

- Your incoming water must be between at least 120°F / 49°C and most 150°F / 66°C but no more than 150°F / 66°C in order to have effective cleaning and prevent damage to your dishware.

**Note:** The minimum incoming temperature must be at 120°F/49°C in order to dissolve detergent properly.

If you are not sure of what degree your hot water temperature is at:

1. Simply open the hot water faucet and let it run for a minute and fill a glass.
2. Take a thermometer and check the temperature of the water.
3. If the temperature is below 120°F / 49°C, then you need to adjust water regulator in order to maintain that temperature level.

**Note:** We recommend that you select hot water instead of cold water from the faucet to reduce the time to heat up the water and to have the detergent properly dissolve in the water quickly in order to clean the dishware effectively. Your unit is equipped with heater that will automatically increase the water temperature quickly to remove grease and soil off the dishware and dissolve detergent properly.

**Overflowing Protection:**

- In the event the water flowing into the machine is not cut off as foreseen by the program and the water level rises above the highest acceptable point, the security pressure switch automatically activates the drainage pump which immediately empties the water.
- This happens when the machine is operating (ON). When the machine is in "OFF" position, the water supply to the dishwasher must be shut at the end of the program in order to isolate the machine from the pressure in the network. This is especially necessary if you will be absent from your home.

**Understanding Your Filtration System:**

For your convenience, the filtration system is located at the bottom under lower rack with in easy reach inside the tub. It is three level filtration system: Main filter, Coarse filter and Fine filter.

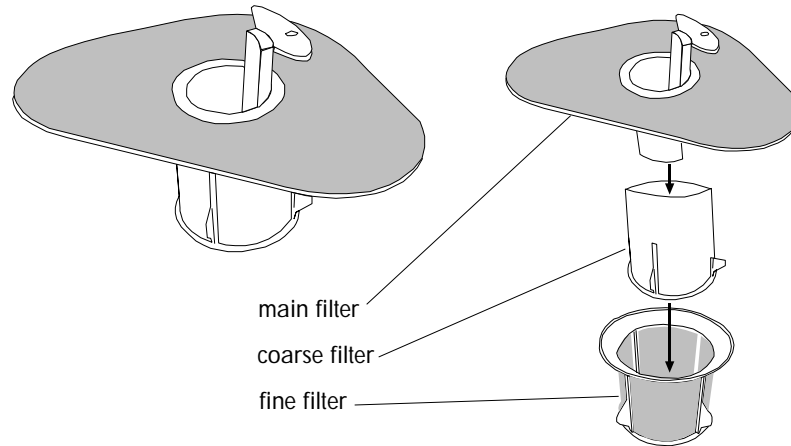

**Main Filter:** The purpose of this filter is to trap food and soil particles.

**Coarse Filter:** The purpose of this filter is to trap large items such as pieces of bone or glass that might clog the drain.

**Fine Filter:** The purpose of this filter is to trap and hold tiny soil and food residue and prevent it from being re-deposited on the dishes during a cycle.

**Warning:** Never run your dishwasher without the filters in place.

**Tips to avoid stains and films:**

The following suggestions are recommended to prevent stains and films from dishware and utensils items:

- You must rinse all dishware, silverware, glassware and food containers right a way after use. Some citric based food products, coffee, tea and iron deposits in water can cause yellow or brown film on inside surface when left on for a long time and not rinsed immediately.
- You must check your water hardness to see whether you need to use more or less detergent to wash. If water is extremely hard then it may be causing stains on items. You may need to use water softener.
- Do not over load the dishwasher.
- Avoid improper loading.
- Make sure there is a proper water temperature that is recommended to wash dishware.
- Do not use too little detergent.
- Do not use old or damp powder detergent.
- Do not load aluminum utensils improperly. Aluminum utensils can cause gray or black marks to porcelain utensils if touching during wash cycle.

## Care and Cleaning Guide

### General Cleaning and Maintenance:

- Do not use abrasive, harsh cleaners, solvents, concentrated detergents or metal scouring pads to clean the inside of dishwasher.
- Use warm soapy water with soft brush or piece of cloth to clean the interior of a tub.
- Clean around the tub gasket with a damp cloth.
- When cleaning control panel, use a lightly dampened cloth around it then dry thoroughly.
- When cleaning exterior cabinet, use lightly soapy water with soft piece of cloth.
- Do not use any sharp objects that can scratch the cabinet surface.

### Cleaning Dishwasher Filters:

- The filters are located inside of the dishwasher at the bottom front below the lower rack.
- After wash and dry cycle is finished, you must wait few minutes until the dishwasher is completely cooled off in order to remove the filters to clean.
- Remove the lower rack first in order to take the filter out.
- Remove and clean any residue off the filters using soap and water; then wipe them off with a soft piece of cloth.
- After you finish cleaning the filters place them back to their original position in the dishwasher.
- We recommend that you wash and clean all three filters gently in hot, soapy water and rinse them thoroughly periodically to clean soil and chemical build up on the filters.

**Preventing Your Dishwasher from Freezing:**

You must protect your dishwasher if it is left in an unheated place during the winter.

- You must cut off electrical power to the dishwasher.
- You must turn off the water supply and disconnect the water inlet line from the water valve.
- You must drain water from the water inlet into the sink or pan.

**Storage of Your Dishwasher in Cold Environment:**

- You must store the dishwasher at room temperature.
- Do not install or operate your dishwasher where the temperature is below freezing.
- If you just got a delivery of a dishwasher when outside temperature is below freezing, do not operate until dishwasher has warmed to a room temperature.

## Troubleshooting

### **Dishwasher does not work:**

- Check if the unit is plugged in. The plug may have come loose.
- Check if the electrical wall receptacle is of proper voltage.
- Check if circuit breaker needs to be reset or if the fuse needs to be replaced.
- Check if the unit is on "Off" mode.
- Check if the door is open. You may have to close the door properly.

### **Dishware and glassware/flatware are cloudy and not cleaned:**

- Use of old or poor detergent.  
You need to make sure that detergent is fresh.
- The water may be hard in your area.  
You may need to install water softener.
- Spray arms may be blocked.  
You may need to rearrange dishware and utensils.
- Water pressure may be low.  
You may need to adjust the water pressure.  
Make sure it is between 20 to 120 (PSI).
- Water temperature may be lower than what is recommended.  
(120 Degree F / 49 Degree C) You may need to adjust water regulator.
- Overloading of dishware.  
You may need to rearrange or remove some dishware from the load.
- May have selected wrong cycle.  
You may need to select proper cycle.

### **Dishes are not dry:**

- Vented dry option is off.  
You need to check if vented dry option is "ON" position.
- Low water temperature.  
You may need to regulate water temperature to 120 Degree F / 49 Degree C.

**Dishware chipped:**

- This is due to poor loading or overloading. You need to be careful when loading. Do not overload. You need to place glassware securely against pins. Make sure delicate items are on the side rack. We recommend that fine chinaware or crystal items should be hand washed.

**Noise:**

Some of the sounds you will hear are normal.

- You will hear sound of the water fill and rinse.
- You will hear drain valve opening to pump water out.
- You will hear motor stopping at the end of the cycle.
- If some utensils are not secure in the rack, you will hear that they are being tossed around the tub.

**Oversudsing:**

This is due to use of regular hand washing detergent.

You may need to check if the detergent is for "Automatic Dishwasher Use". If not then you need to use the proper detergent that is for dishwasher.

**Dishware has an odor:**

- This is due to incomplete cycle.  
You need to allow cycle to be fully completed.
- New scented detergent used.  
This is normal because different types of detergents may have different fragrances.

**Etching:**

- Too much detergent used.  
Use the appropriate amount of detergent. Reduce amount of detergent used per load.
- The water temperature is too hot.  
You need to lower water temperature.



- Use of old detergent.  
Avoid using old detergent. Read expiration date. Use only fresh detergent.
- Vented dry heat is too harsh on some dishware.  
You may need to use air dry option by leaving your door open for a while.

#### **Stained in interior tub:**

- Some detergents contain colorant known as "pigment" or "dyes" that will discolor the tub with extended use. You need to change detergent without any colorant. Read container label carefully before use of the detergent.
- Some "acid based" and "paste based" foods may discolor the tub. Use of rinse cycle helps to decrease the level of staining.

#### **Spots & filming found on flatware/glassware:**

This is due to:

- Use of too little detergent.
- Low incoming water temperature and pressure.
- Improper loading.
- Use of old, moist and damp powder detergent.
- Hard water in you area.

## **Water**

#### **Draining Problem:**

- Check the level of the drain hose. The drain hose should be positioned above the drain in order to drain properly. (See Installation Section on page #27)
- If the drain hose is bent or shrunken, it may affect water draining.
- If water can not be drained out smoothly, the dishwasher operation will be disturbed and it may stop in the middle of the cycle.

**Note:** If for any reason the dishwasher malfunctions during the operation, follow the steps below to drain the water out.

- 1) Shut off the dishwasher and wait few seconds.
- 2) Turn on the power again by pressing power button.  
Press Start/Pause button. After few seconds drain pump will come on for short period of time twice. You will hear some type drain pump noise in the dishwasher. Observe if the drain hose is pumping water out in to the sink.
- 3) Immediately turn off the dishwasher after the second drain.
- 4) If there is still water left in the dishwasher, repeat first three steps again until the water is removed completely.

#### **Water is not pumping out of the tub:**

- Drain is clogged.  
Make sure that your kitchen sink is draining well. If not, call a plumber.

#### **Dishwasher is leaking:**

- Dishwasher is not leveled properly.  
You need to place the dishwasher on the flat hard surface. Avoid uneven surface.
- The tub may be cracked.  
If the tub is cracked then you need to call for service.

#### **Dishwasher will not fill:**

- Check water supply.  
Make sure that water supply is at "On" position instead of "Off" position.
- Check water pressure.  
Make sure the water pressure is at proper level. (Between 20 – 120 PSI)

#### **Water found under the filter:**

This is normal. After water is drained out, a small amount of water found under the filter area due to different settings and shapes of food containers in the lower rack. The water will be drained out first in next wash operation automatically.

# INSTALLATION INSTRUCTIONS

## Tools and Materials Required

You will need to have following tools to help you in the installation of your Washer:

- Scissors
- Pliers
- Wrench
- Tape Measure
- Gloves
- Level

Accessories Supplied	Quantity
1. Water Inlet Hose	1
2. Quick Connect Sink Adapter set	1
3. Casters (factory installed)	4
4. Rubber Washers	4

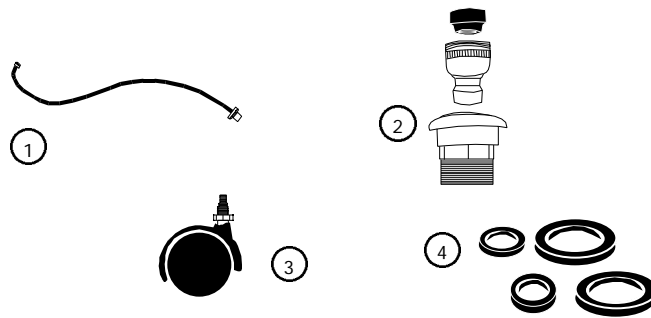

## Unpacking Your Dishwasher

- Remove all packing materials including all adhesive tape holding the accessories inside and outside.
- Inspect and remove any remains of packing, tape or printed materials before using the dishwasher.

## Steps for Installation

Please read installation instructions carefully and follow the steps below to hook up your dishwasher.

**Caution:** If, after completing these steps, you are unsure that unit is properly installed, contact a qualified installer. To ensure that your appliance is properly installed it is recommended that you get a certified installer.

In order for this dishwasher to work, the following are required:

- HOT WATER SUPPLY (cold can be use as well, see page#17 under "checking water temperature section")
- DRAINAGE FOR USED WATER
- ELECTRICITY: 115 VOLT, 60Hz Outlet
- GROUNDING
- HORIZONTAL FLAT SURFACE

1. Your dishwasher must be placed on horizontal flat surface near by the sink.  
Placing the dishwasher as near to a sink as possible to allow for proper installation of the water inlet and drainage hoses.
2. Connect water inlet hose to the hot water faucet and to the water inlet valve on the back of the dishwasher. **(Quick Connect Sink Adapter is supplied)**
3. The other end of the drain hose must be placed properly in the sink or at your drain outlet in order to let used water drained out from the dishwasher.

**Note:** The drain hose must be placed into a drainpipe or sink at least 1-1/2" in diameter. Use the gooseneck to hold hose in place. The minimum size of drainpipe must be 1-1/2" in diameter. The height of drainpipe must be 15-3/4" minimum. To avoid possible water back up, the drain hose must reach height of at least 36-1/2" maximum.

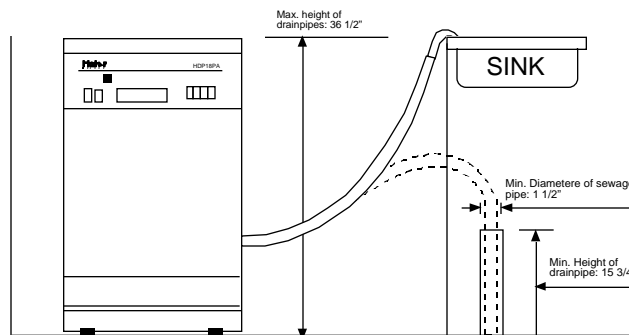

4. Plug in the dishwasher to a regular 115 Volt / 60 Hz, 15 Amp. Outlet.

**Note:** Inspect carefully for any water leak around and back of the machine. If any leak occurs, double check to see if any connections are loose. You may need to tighten any loose connections.

### Installing Quick Connect Sink Adapter:

When installing quick Connect Sink Adapter to the faucet, follow the steps below:

- A. First remove the aerator from your faucet nozzle and determine the size/type of the faucet.
- B. Once you determine the size/type of the faucet (Outside Threaded End or Inside Threaded End), place the proper size of rubber washer in silver faucet adapter.
- C. Attach the silver faucet connector to the faucet.
- D. Attach faucet connector with water inlet hose by making sure that rubber washer goes in between.
- E. Attach the other end of the water inlet hose (Red Color End) to the dishwasher water inlet by making sure that rubber washer goes in between.

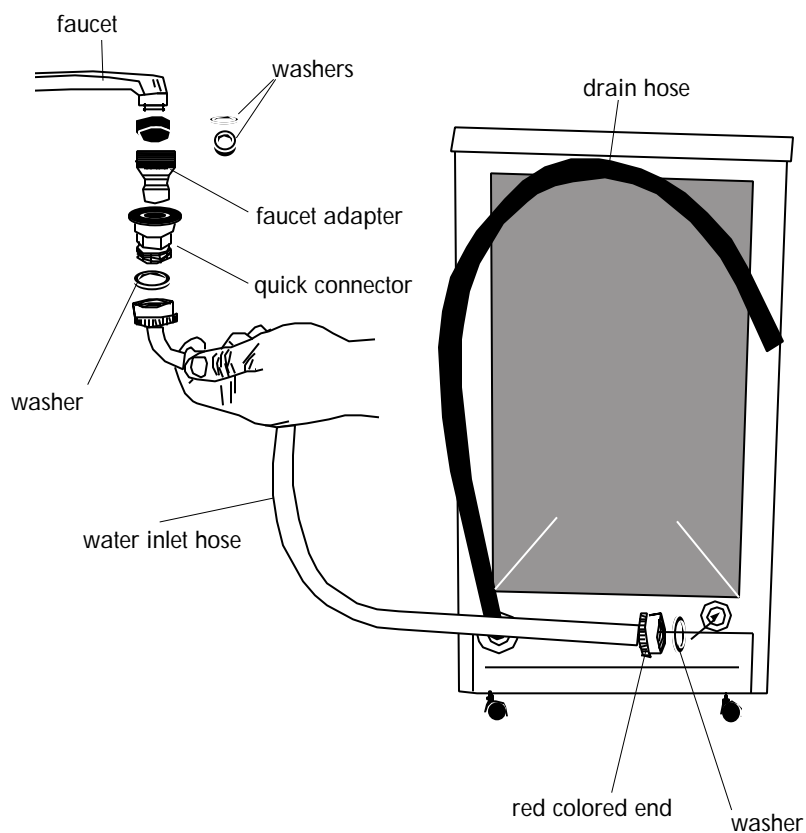

# Electrical Connections

## Grounding Instructions

This appliance must be grounded. In the event of an electrical short circuit, grounding reduces the risk of electric shock by providing an escape wire for the electric current. This appliance is equipped with a cord having a grounding wire with a grounded plug. The plug must be inserted into an outlet that is properly installed and grounded.



- Improper use of the plug can result in a risk of electric shock.
- Consult a qualified electrician or service person if the grounding instructions are not completely understood or if doubt exists as to whether the appliance is properly grounded.

### Wiring Requirements:

- This appliance must be plugged into at least 15 AMP 115-120 VOLT, 60 HZ GROUNDED OUTLET.

**Note:** Where a standard two-prong outlet is encountered, it is the personal responsibility and obligation of the consumer to have it replaced with a properly grounded three-prong outlet.

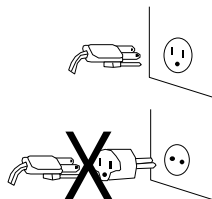

### Extension Cords:

We do not recommend that you use an extension cord.

## Power Interruptions

Occasionally there may be power interruptions due to thunderstorms or other causes. Remove the power cord from AC outlet when a power outage occurs. When power has been restored re-plug power cord to AC outlet. If outage is for a prolonged period, clean dishwasher before using it again.