



AVer Vandal Dome Type Camera

Installation Guide



Table of Contents

IMPORTANT SAFEGUARD	1
PACKAGE CONTENTS	2
OPTIONAL ACCESSORIES	2
IP CAMERA PARTS	3
IP CAMERA INSTALLATION	4
DEPLOYING NETWORK	4
Network Connection via Ethernet Switch	4
Connect the power adapter to power jack of camera.....	4
Power over Ethernet Connection	5
CONNECTING EXTERNAL DEVICES TO I/O TERMINAL BLOCK	6
INTERNAL CONNECTION DIAGRAM OF DI/DO	6
MOUNTING THE IP CAMERA	7
FOCUSING THE IP CAMERA WITH BNC MONITOR	8
INSERTING MICROSD CARD TO SYSTEM.....	9
RESETTING HARDWARE	10
TECHNICAL SPECIFICATIONS	11
FV2028-T (E)/FV2028-TM (E)	11
FV3028-RT (E)/FV3028-RTM (E)	15
FV2028 (E)	19
FCC NOTICE (CLASS B)	23
NOTICE	23
WARNING	23
GOVERNING LAW AND YOUR RIGHTS	25

Important Safeguard

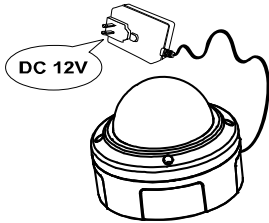

Do not use power supply with different voltage other than DC 12V / PoE.

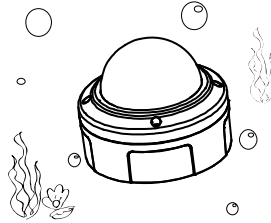

Do not submerge the unit in the water.

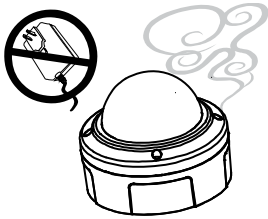

Unplug the power of this unit as soon as smoke or unusual odor is detected.



Unplug the power supply before cleaning. Use only a lens cleaning cloth and never use benzene, thinner, or other solvent for cleaning.

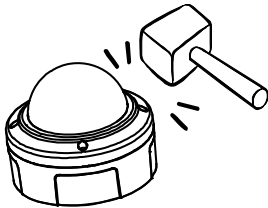

Do not attempt to service this unit by yourself. Always refer all servicing to qualified service personnel.

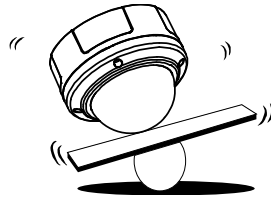

Do not place the unit in unsteady surface and also do not drop the unit.



Keep the IP camera housing close and prevent the dust from getting in the housing.

Package Contents

The following items are included in the package.

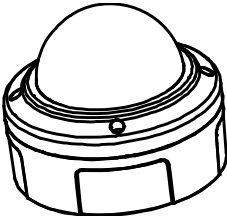

AVer Vandal Dome type
Camera



Software & Manual CD

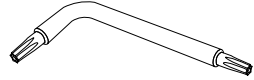

L-type Wrench

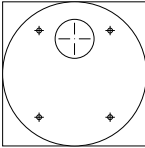

Alignment Sticker



4 Screws

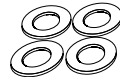

4 Washers

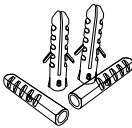

4 Plastic Anchors

Optional Accessories

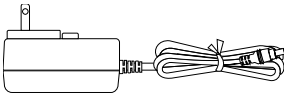

Power Adapter (12V, 2A)

* The power adapter will vary depending on the standard power outlet of the country where it is sold. Depending on your package the power adapter maybe included.

IP Camera Parts

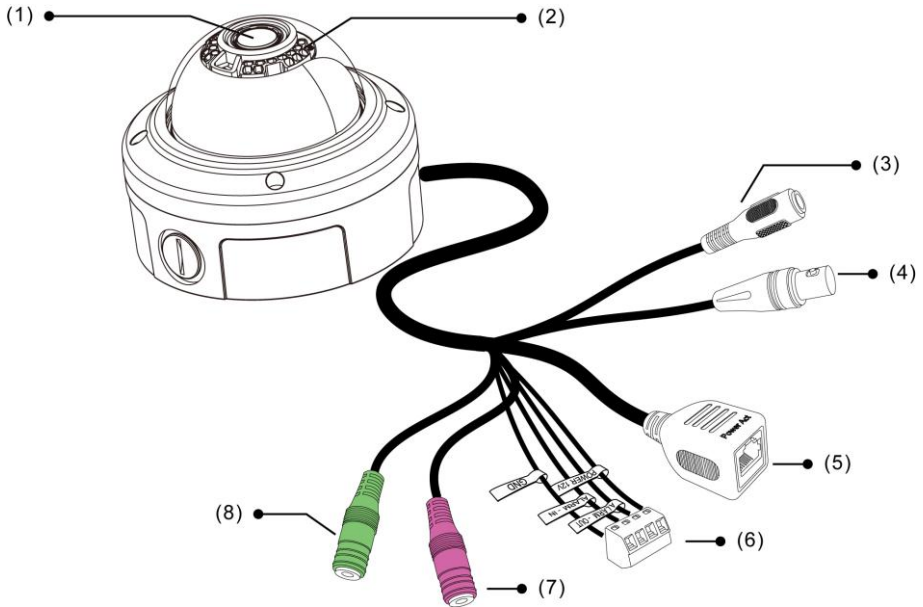

No.	Function
(1)	Camera Lens
(2)	Light Sensor
(3)	Power Jack
(4)	BNC Jack (Video Out)
(5)	RJ45 Ethernet Jack
(6)	I/O Terminal Block
(7)	Phone Jack (Audio In)
(8)	Phone Jack (Audio Out)

IP Camera Installation

This section provides useful tips on how to adjust the IP camera to meet your needs.

Deploying Network

Network Connection via Ethernet Switch

Connect the RJ45 cable from the Ethernet switch to RJ45 Ethernet jack of camera

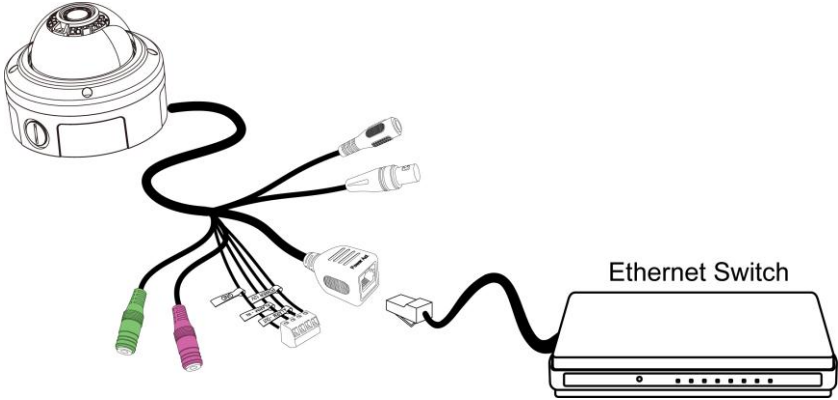

Connect the power adaptor to power jack of camera

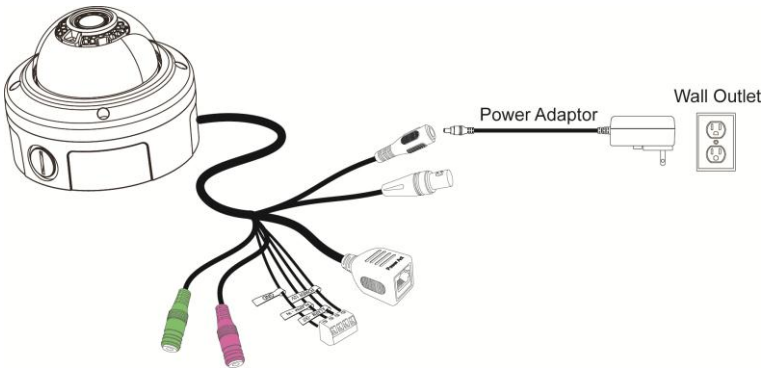

Power over Ethernet Connection

Aver vandal dome type camera fully complies with PoE standard. It allows you to use PoE enabled switch or PoE injector to transmit data and power thru single Ethernet cable.

■ PoE Enabled Switch Connection Diagram

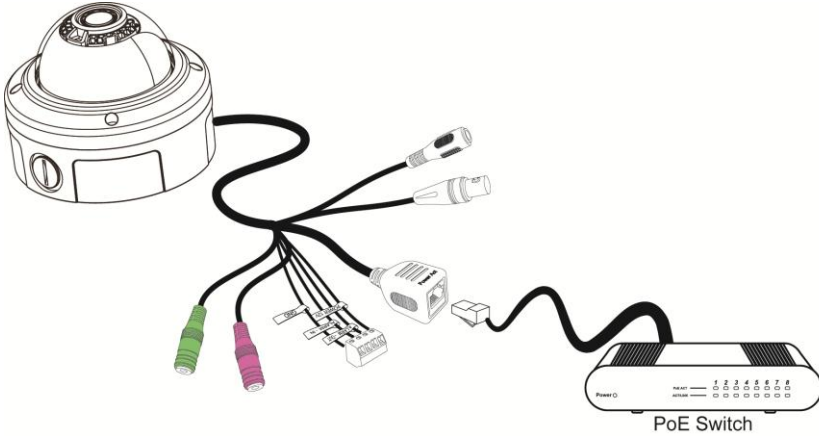

■ PoE Injector Connection Diagram

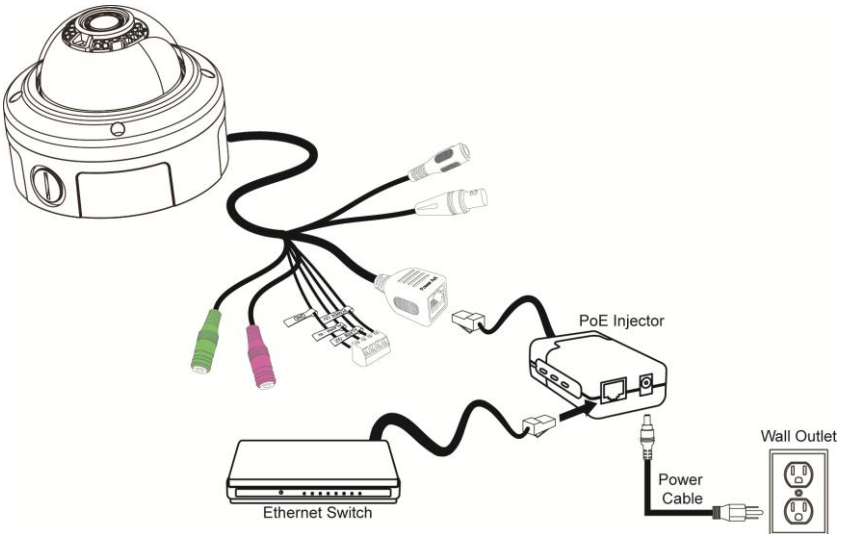

Connecting External Devices to I/O Terminal Block

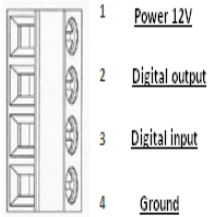

No.	Function
(1)	Power 12V
(2)	Digital Output
(3)	Digital Input
(4)	Ground

[Note] Maximum power output is 12V/100mA

Internal Connection Diagram of DI/DO

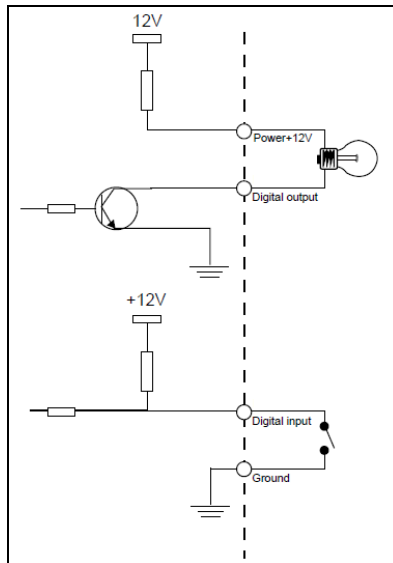

Mounting the IP Camera

1. Place the sticker on the wall surface. Then spot the mark and drill the 5 holes indicated on the sticker. If you are going to run the wire through the lateral side, it's not necessary to drill through the big hole.
2. Insert the 4 plastic anchors in the wall.
3. Hook the IP Camera and place the washer on the 4 screws. Use the hex socket cap bolt to secure the IP camera.
4. After adjusting the focus and zoom control, use the L-type wrench to secure the case of IP camera from being tampered.

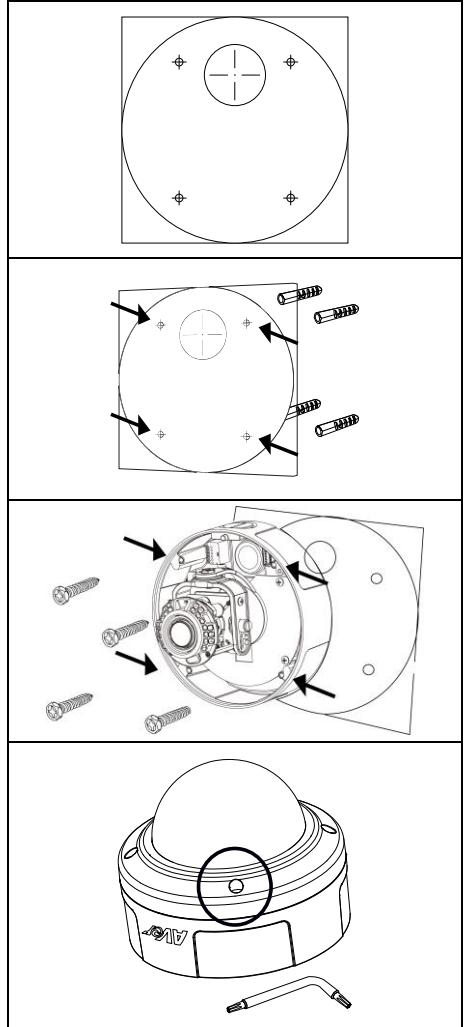

Focusing the IP Camera with BNC Monitor

The IP camera is supported with BNC analog video out jack which allows you to connect an analog display devices such as an LCD BNC monitor for you to adjust the camera focus and zoom.

1. Connect the LCD BNC monitor to the BNC jack.

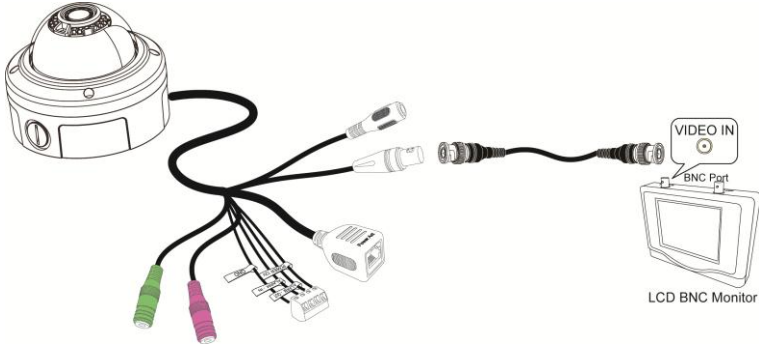

2. Open up the IP camera case.

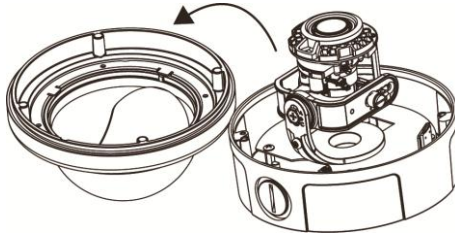

3. Slightly loosen the focus and zoom control knobs and adjust the focus and zoom range. Slightly tighten the focus and zoom knobs once you are done the adjustment.

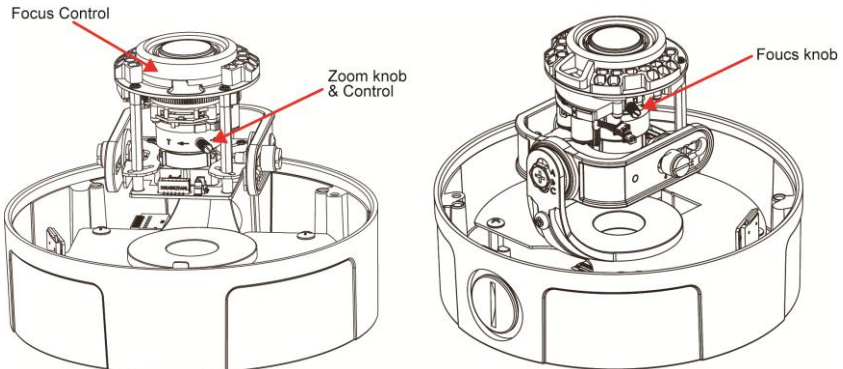

Inserting microSD Card to System

1. Open up the IP camera case.

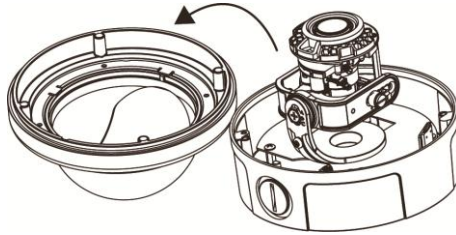

2. Insert microSD card

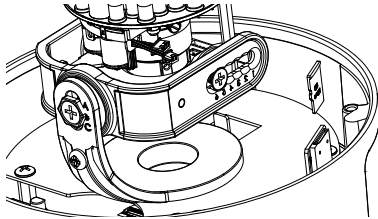

[Note] We recommend to use industrial grade microSD card (support operating temp from -40°C to 85°C) for extreme temperature condition.

Resetting Hardware

1. Open the IP camera case.

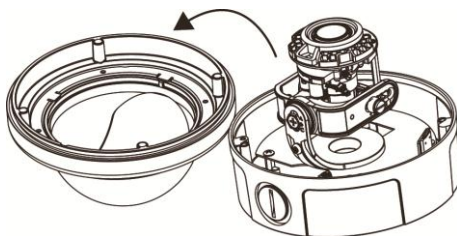

2. Short PJ1 pins around 10 seconds.

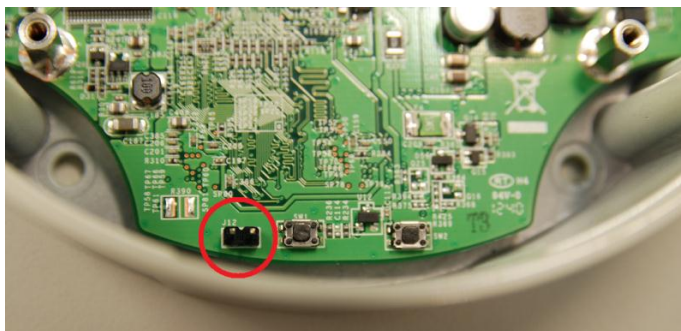

Warning!!

This will cause all the configuration settings back to factory default.

Technical Specifications

■ FV2028-T (E)/FV2028-TM (E)

Model	FV2028-T (E)	FV2028-TM (E)
Lens spec.	CBC AG3Z0312LMRP-N	CBC AGP3Z0312LMRP-E111T51
Lens type	vari-focal Lens (Board mount, M19)	
F/no	F/1.2	
Iris type	DC Iris	
Focal length	f3~9mm	
View Angle	H 115.2°(W)~10.1°(T) V 74.9°(W)~23.1°(T)	
MFZ support	N/A	Yes
Camera image		
Min. illumination	0.4 Lux in day mode (IR off) 0.05 Lux in night mode (IR off) 0 Lux in night mode (IR on)	
Built-in LED	Yes	
IR distance	30M	
Built-in mechanical ICR	Yes	
Auto IRIS	Yes	
Video		
Compression	H.264/MPEG-4/MJPEG	
Max. resolution	1920 x 1080	
Frame rate	1920 x 1080 @ 30fps	
H.264/MPEG-4 bit rate mode	VBR, 5 levels CBR, 64/128/512/768Kbps & 1/2/3/4/6/8/10/12Mbps	
MJPEG quality	5 levels	
Regional of Interest	Yes	
Smart Stream	Yes, 5 windows	
Image orientation	mirror, flip	
Motion Detection zones	3	

Model	FV2028-T (E)	FV2028-TM (E)
Video		
Privacy mask areas	3	
BLC	Yes	
D-WDR	Yes	
De-noise	2D/3D	
Day & night function	Auto/Manual/Schedule	
ePTZ	Yes	
Corridor Mode	Yes	
Cross Detection	Yes	
Audio		
Encoder	G.711 (μ -law)/G.726 (bit rate 16K-64bps) /AAC audio compression	
Streaming	2-ways audio	
Microphone	external microphone input	
Network		
protocols	TCP/IP (IPv4/IPv6), HTTP, HTTPS, UPnP, SMTP, FTP, DHCP, NTP, DDNS, PPPoE, Samba, QoS, SNMP(V1/V2c/V3), 802.1X	
Ethernet	10/100 Base-T, RJ45 connector	
ONVIF	V2.X (Profile S), conformance test V12.06	
Security	Password protection/IP Filter	
Users	up to 10 users simultaneously	
Event		
Profiles	32 sets	
Triggers	Alarm Interval, Motion Detection Region, Digital Input, SD Card, Network	
Actions	Trigger: Digital Output, Alarm Audio Send out video clip: FTP, NAS, SD card Send out snapshot / log: FTP, NAS, SD card, mail	

Model	FV2028-T (E)	FV2028-TM (E)
Interface		
Digital input/output	1/1	
BNC Video output	Yes	
Built-in storage option	Micro SDHC & SDXC card (64GB max.)	
Built-in microphone	N/A	
External microphone input	Yes	
External Audio output	Yes	
General		
Power supply	DC 12V(2A)/PoE	
Power consumption	PoE (TYP.):	
	7W (LED/Heater off)	
	14W (LED on, Heater off)	
	15W (LED off, Heater on)	
	22W (LED/Heater on)	
Power consumption	DC-IN (TYP.):	
	5W (LED/Heater off)	
	12W (LED on, Heater off)	
	13W (LED off, Heter on)	
	20W (LED/Hearer on)	
PoE	PoE Class 4 (IEEE802.3at)	
Dimensions	φ 144.3 x H114.4 (mm)	
3-axis bracket adjustment angle	pan: 280°, tilt: 30°~90°, rotation: 100°	
Net weight	1200g	
Temperature and humidity	-15°C~50°C, 20%~90% Cold Start -50°C~50°C, 20%~90% Operating	
IP Rating	IP68	
IK Rating	IK10	

Model	FV2028-T (E)	FV2028-TM (E)
Software Requirement		
OS	Windows® XP/7/8	
Browser	IE 8/9/10/11 (Full Function), Chrome Firefox and Safari (Basic Function)	
Firmware remote upgrade	Yes (via HTTP)	
Bundled Software		
ExpreeGO	free up to 32CH	
IPCAM Utility	Yes	
SecureCenter	Yes	
Warranty		
Main body	3 years	
Accessories	1 year	

■ FV3028-RT (E)/FV3028-RTM (E)

Model	FV3028-RT (E)	FV3028-RTM (E)
Lens spec.	CBC AG3Z0312LMRP-N	CBC AGP3Z0312LMRP-E111T51
Lens type	vari-focal Lens (Board mount, M19)	
F/no	F/1.2	
Iris type	DC Iris	
Focal length	f3~9mm	
View Angle	H 92°(W)~30.2°(T) V 65.2°(W)~23.2°(T)	
MFZ support	N/A	Yes
Camera image		
Min. illumination	0.8 Lux in day mode (IR off) 0.1 Lux in night mode (IR off) 0 Lux in night mode (IR on)	
Built-in LED	Yes	
IR distance	30M	
Built-in mechanical ICR	Yes	
Auto IRIS	Yes	
Video		
Compression	H.264/MPEG-4/MJPEG	
Max. resolution	2048 x 1536	
Frame rate	2048 x 1536 @ 20fps (Wide Angle) 1920 x 1080 @ 30fps (Normal mode)	
H.264/MPEG-4 bit rate mode	VBR, 5 levels CBR, 64/128/512/768Kbps & 1/2/3/4/6/8/10/12Mbps	
MJPEG quality	5 levels	
Regional of Interest	Yes	
Smart Stream	Yes, 5 windows	
Image orientation	mirror, flip	
Motion Detection zones	3	

Model	FV3028-RT (E)	FV3028-RTM (E)
Video		
Privacy mask areas	3	
BLC	Yes	
Sensor-WDR	Yes	
De-noise	2D/3D	
Day & night function	Auto/Manual/Schedule	
ePTZ	Yes	
Corridor Mode	Yes	
Cross Detection	Yes	
Audio		
Encoder	G.711 (μ -law)/G.726 (bit rate 16K-64bps) /AAC audio compression	
Streaming	2-ways audio	
Microphone	External microphone input	
Network		
Protocols	TCP/IP (IPv4/IPv6), HTTP, HTTPS, UPnP, SMTP, FTP, DHCP, NTP, DDNS, PPPoE, Samba, QoS, SNMP(V1/V2c/V3), 802.1X	
Ethernet	10/100 Base-T, RJ45 connector	
ONVIF	V2.X (Profile S), conformance test V12.06	
Security	Password protection/IP Filter	
Users	up to 10 users simultaneously	
Event		
Profiles	32 sets	
Triggers	Alarm Interval, Motion Detection Region, Digital Input, SD Card, Network	
Actions	Trigger: Digital Output, Alarm Audio Send out video clip: FTP, NAS, SD card Send out snapshot / log: FTP, NAS, SD card, mail	

Model	FV3028-RT (E)	FV3028-RTM (E)
Interface		
Digital input/output	1/1	
BNC Video output	Yes	
Built-in storage option	Micro SDHC & SDXC card (64GB max.)	
Built-in microphone	N/A	
External microphone input	Yes	
External Audio output	Yes	
General		
Power supply	DC 12V(2A)/PoE	
Power consumption	PoE (TYP.):	
	7W (LED/Heater off)	
	14W (LED on, Heater off)	
	15W (LED off, Heater on)	
	22W (LED/Heater on)	
Power consumption	DC-IN (TYP.):	
	5W (LED/Heater off)	
	12W (LED on, Heater off)	
	13W (LED off, Heter on)	
	20W (LED/Hearer on)	
PoE	PoE Class 4 (IEEE802.3at)	
Dimensions	φ 144.3 x H114.4 (mm)	
3-axis bracket adjustment angle	pan: 280°, tilt: 30°~90°, rotation: 100°	
Net weight	1200g	
Temperature and humidity	-15°C~50°C, 20%~90% Cold Start -50°C~50°C, 20%~90% Operating	
IP Rating	IP68	
IK Rating	IK10	

Model	FV3028-RT (E)	FV3028-RTM (E)
Software Requirement		
OS	Windows® XP/7/8	
Browser	IE 8/9/10/11 (Full Function), Chrome Firefox and Safari (Basic Function)	
Firmware remote upgrade	Yes (via HTTP)	
Bundled Software		
ExpressGO	free up to 32CH	
IPCAM Utility	Yes	
SecureCenter	Yes	
Warranty		
Main body	3 years	
Accessories	1 year	

■ FV2028 (E)

Model	FV2028 (E)	
Lens spec.	PTK-2M2812N14IR	
Lens type	vari-focal Lens (Board mount, M14)	
F/no	F/1.4	
Iris type	DC Iris	
Focal length	2.8~12mm	
View Angle	H 81.4°(W)~29°(T) V 50.1°(W)~18°(T)	
Camera image		
Min. illumination	1 Lux in day mode (IR off) 0.15 Lux in night (IR off) 0 Lux in night mode (IR on)	
Built-in LED	Yes	
IR distance	30M	
Built-in mechanical ICR	Yes	
Auto IRIS	Yes	
Video		
Compression	H.264/MPEG-4/MJPEG	
Max. resolution	1920 x 1080	2048 x 1536
Frame rate	1920 x 1080 @ 30fps	2048 x 1536 @ 20fps (Wide Angle)
H.264/MPEG-4 bit rate mode	VBR, 5 levels CBR, 64/128/512/768Kbps & 1/2/3/4/6/8/10/12Mbps	
MJPEG quality	5 levels	
Regional of Interest	Yes	
Smart Stream	Yes, 5 windows	
Image orientation	mirror, flip	

Model	FV2028 (E)
Video	
Motion Detection zones	3
Privacy mask areas	3
BLC	Yes
D-WDR	Yes
De-noise	2D/3D
Day & night function	Auto/Manual/Schedule
ePTZ	Yes
Corridor Mode	Yes
Cross Detection	Yes
Audio	
Encoder	G.711 (μ -law)/G.726 (bit rate 16K~64bps) /AAC audio compression
Streaming	2-ways audio
Microphone	External microphone input
Network	
protocols	TCP/IP (IPv4/IPv6), HTTP, HTTPS, UPnP, SMTP, FTP, DHCP, NTP, DDNS, PPPoE, Samba, QoS, SNMP(V1/V2c/V3), 802.1X
Ethernet	10/100 Base-T, RJ45 connector
ONVIF	V2.X (Profile S), conformance test V12.06
Security	Password protection/IP Filter
Users	up to 10 users simultaneously
Event	
Profiles	32 sets
Triggers	Alarm Interval, Motion Detection Region, Digital Input, SD Card, Network
Actions	Trigger: Digital Output, Alarm Audio Send out video clip: FTP, NAS, SD card Send out snapshot / log: FTP, NAS, SD card, mail

Model	FV2028 (E)
Interface	
Digital input/output	1/1
BNC Video output	Yes
Built-in storage option	Micro SDHC & SDXC card (64GB max.)
Built-in microphone	N/A
External microphone input	Yes
External Audio output	Yes
General	
Power supply	DC 12V(2A)/PoE
Power consumption	PoE (TYP.): 7W (LED off) 14W (LED on)
	DC-IN (TYP.): 5W (LED off) 13W (LED on)
PoE	PoE Class 3 (IEEE802.3at)
Dimensions	φ 144.3 x H114.4 (mm)
Net weight	1200g
3-axis bracket adjustment angle	pan: 280°, tilt: 30°~90°, rotation: 100°
Temperature and humidity	-15°C~50°C, 20%~90% Cold Start -25°C~50°C, 20%~90% Operating
IP Rating	IP68
IK Rating	IK10

Model	FV2028 (E)
Software Requirement	
OS	Windows® XP/7/8
Browser	IE 8/9/10/11 (Full Function), Chrome Firefox and Safari (Basic Function)
Firmware remote upgrade	Yes (via HTTP)
Bundled Software	
ExpressGO	free up to 32CH
IPCAM Utility	Yes
SecureCenter	Yes
Warranty	
Main body	2 years
Accessories	1 year

FCC NOTICE (Class B)



This device complies with Part 15 of the FCC Rules. Operation is subject to the following two conditions: (1) this device may not cause harmful interference, and (2) this device must accept any interference received, including interference that may cause undesired operation.

Federal Communications Commission Statement

NOTE- This equipment has been tested and found to comply with the limits for a Class B digital device, pursuant to Part 15 of the FCC Rules. These limits are designed to provide reasonable protection against harmful interference in a residential installation. This equipment generates uses and can radiate radio frequency energy and, if not installed and used in accordance with the instructions, may cause harmful interference to radio communications. However, there is no guarantee that interference will not occur in a particular installation. If this equipment does cause harmful interference to radio or television reception, which can be determined by tuning the equipment off and on, the user is encouraged to try to correct the interference by one or more of the following measures:

- Reorient or relocate the receiving antenna.
- Increase the separation between the equipment and receiver.
- Connect the equipment into an outlet on a circuit different from that to which the receiver is connected.
- Consult the dealer or an experienced radio/television technician for help.

European Community Compliance Statement (Class B)



This product is herewith confirmed to comply with the requirements set out in the Council Directives on the Approximation of the laws of the Member States relating to Electromagnetic Compatibility Directive 2004/108/EC

COPYRIGHT

© 2014 AVer Information Inc. All rights reserved.

All rights of this object belong to AVer Information Inc. Reproduced or transmitted in any form or by any means without the prior written permission of AVer Information Inc. is prohibited. All information or specifications are subject to change without prior notice. "AVer" is a trademark owned by AVer Information Inc. Other trademarks used herein for description purpose only belong to each of their companies.

NOTICE

SPECIFICATIONS ARE SUBJECT TO CHANGE WITHOUT PRIOR NOTICE. THE INFORMATION CONTAINED HEREIN IS TO BE CONSIDERED FOR REFERENCE ONLY.

WARNING

TO REDUCE RISK OF FIRE OR ELECTRIC SHOCK, DO NOT EXPOSE THIS APPLIANCE TO RAIN OR MOISTURE. WARRANTY VOID FOR ANY UNAUTHORIZED PRODUCT MODIFICATION.



THE MARK OF CROSSED-OUT WHEELED BIN INDICATES THAT THIS PRODUCT MUST NOT BE DISPOSED OF WITH YOUR OTHER HOUSEHOLD WASTE. INSTEAD, YOU NEED TO DISPOSE OF THE WASTE EQUIPMENT BY HANDING IT OVER TO A DESIGNATED COLLECTION POINT FOR THE RECYCLING OF WASTE ELECTRICAL AND ELECTRONIC EQUIPMENT. FOR MORE INFORMATION ABOUT WHERE TO DROP OFF YOUR WASTE EQUIPMENT FOR RECYCLING, PLEASE CONTACT YOUR HOUSEHOLD WASTE DISPOSAL SERVICE OR THE SHOP WHERE YOU PURCHASED THE PRODUCT.

Limited Warranty

Aver Information, Inc. (“Aver”) warrants that the applicable product (“Product”) substantially conforms to AVer’s documentation for the product and that its manufacture and components are free of defects in material and workmanship under normal use. “You” as used in this agreement means you individually or the business entity on whose behalf you use or install the product, as applicable. This limited warranty extends only to You as the original purchaser. Except for the foregoing, the Product is provided “AS IS.” In no event does AVer warrant that You will be able to operate the Product without problems or interruptions, or that the Product is suitable for your purposes. Your exclusive remedy and the entire liability of AVer under this paragraph shall be, at AVer’s option, the repair or replacement of the Product with the same or a comparable product. This warranty does not apply to (a) any Product on which the serial number has been defaced, modified, or removed, or (b) cartons, cases, batteries, cabinets, tapes, or accessories used with this product. This warranty does not apply to any Product that has suffered damage, deterioration or malfunction due to (a) accident, abuse, misuse, neglect, fire, water, lightning, or other acts of nature, commercial or industrial use, unauthorized product modification or failure to follow instructions included with the Product, (b) misapplication of service by someone other than the manufacturer’s representative, (c) any shipment damages (such claims must be made with the carrier), or (d) any other causes that do not relate to a Product defect. The Warranty Period of any repaired or replaced Product shall be the longer of (a) the original Warranty Period or (b) thirty (30) days from the date of delivery of the repaired or replaced product.

Limitations of Warranty

Aver makes no warranties to any third party. You are responsible for all claims, damages, settlements, expenses, and attorneys’ fees with respect to claims made against You as a result of Your use or misuse of the Product. This warranty applies only if the Product is installed, operated, maintained, and used in accordance with AVer specifications. Specifically, the warranties do not extend to any failure caused by (i) accident, unusual physical, electrical, or electromagnetic stress, neglect or misuse, (ii) fluctuations in electrical power beyond AVer specifications, (iii) use of the Product with any accessories or options not furnished by AVer or its authorized agents, or (iv) installation, alteration, or repair of the Product by anyone other than AVer or its authorized agents.

Disclaimer of Warranty

EXCEPT AS EXPRESSLY PROVIDED OTHERWISE HEREIN AND TO THE MAXIMUM EXTENT PERMITTED BY APPLICABLE LAW, AVER DISCLAIMS ALL OTHER WARRANTIES WITH RESPECT TO THE PRODUCT, WHETHER EXPRESS, IMPLIED, STATUTORY OR OTHERWISE, INCLUDING WITHOUT LIMITATION, SATISFACTORY QUALITY, COURSE OF DEALING, TRADE USAGE OR PRACTICE OR THE IMPLIED WARRANTIES OF MERCHANTABILITY, FITNESS FOR A PARTICULAR PURPOSE OR NONINFRINGEMENT OF THIRD PARTY RIGHTS.

Limitation of Liability

IN NO EVENT SHALL AVER BE LIABLE FOR INDIRECT, INCIDENTAL, SPECIAL, EXEMPLARY, PUNITIVE, OR CONSEQUENTIAL DAMAGES OF ANY NATURE INCLUDING, BUT NOT LIMITED TO, LOSS OF PROFITS, DATA, REVENUE, PRODUCTION, OR USE, BUSINESS INTERRUPTION, OR PROCUREMENT OF SUBSTITUTE GOODS OR SERVICES ARISING OUT OF OR IN CONNECTION WITH THIS LIMITED WARRANTY, OR THE USE OR PERFORMANCE OF ANY PRODUCT, WHETHER BASED ON CONTRACT OR TORT, INCLUDING NEGLIGENCE, OR ANY OTHER LEGAL THEORY, EVEN IF AVER HAS ADVISED OF THE POSSIBILITY OF SUCH DAMAGES. AVER’S TOTAL, AGGREGATE LIABILITY FOR DAMAGES OF ANY NATURE, REGARDLESS OF FORM OF ACTION, SHALL IN NO EVENT EXCEED THE AMOUNT PAID BY YOU TO AVER FOR THE SPECIFIC PRODUCT UPON WHICH LIABILITY IS BASED.

Governing Law and Your Rights

This warranty gives you specific legal rights; You may also have other rights granted under state law. These rights vary from state to state.