GPS Vehicle Tracker

**USER MANUAL
V5.0**

VT310



Contents

1	Product Overview	3
2	For Your Safety	3
3	VT310 Parameters	3

4 Getting Started	4
4.1 Hardware and Accessories	4
4.2 Light and Button Functionality	4
4.3 Connecting and Installation	5
4.4 Examples of Interfacing Application	6
5 SMS Command	8
5.1 Basic SMS Commands	8
5.1.1 Position Report	8
5.1.2 Set Interval for Automatic Timed Report	8
5.1.3 Stop Automatic Timed Report	8
5.2 GPRS Setting by SMS	8
5.2.1 Set ID for VT310	9
5.2.2 Set APN	9
5.2.3 Set IP Address and Port	9
5.2.4 Set Time Interval for Sending GPRS Packet	9
5.2.5 Enable GPRS Tracking Function	9
6 Tracking on Map	9
7 Troubleshooting	11
8 SMS Command List	12

1 Product Overview

VT310 is a GPS/GSM/GPRS tracking device which is specially developed and designed for vehicle real-time tracking and security. With superior GPS and GPRS modules, VT310 has good sensitivity and stable performance. It can get accurate GPS fix even in remote places.

Main Features:

Tracking via SMS or GPRS (TCP/UDP)
 Current location report
 Tracking by time interval
 Position logging capacity up to 260,000+ waypoints
 Built-in motion sensor for power saving



SOS panic butto
 Geo-fencing control
 Low battery alert
 Speeding alert
 Engine Cut
 Wiretapping (optional)
 Alert when VT310 enters/exits GPS blind area
 Alert when VT310 is turned on
 I/O: 5 digital inputs, 3 negative and 2 positive triggering; 5 outputs.
 Analog Input: 2 10 bits resolution analog inputs

2 For Your Safety

Read these simple guidelines. Not following them may be dangerous or illegal. Read the full user manual for more information.

Proper Connection - When connecting with other device, read carefully its manual so as to carry out correct installation. Do not connect it to other incompatible devices.

Qualified Accessories - Use original parts, qualified batteries and peripheral equipments to avoid damage to VT310.

Safe Driving - Drivers should not operate this product while driving.

Qualified Service - Only qualified personnel can install or repair VT310.

Water Resistance - VT310 is not water resistant. Keep it dry. Install it inside the vehicle or use waterproof bag if necessary.

Confidential Phone Number - For safety reason, do not tell other people the mobile phone number of your VT310 without taking precautions of security settings.

3 VT310 Parameters

Power Supply	+9V - +35V / 1.5A
Backup Battery	850mAh
Dimension	104mm x 62mm x 24mm
Installation Dimension	104mm x 83mm x 24mm

Weight	150g
Operating temperature	-20° to 55° C
Humidity	5% to 95% Non-condensing
Frequency	GSM 900/1800/1900Mhz or GSM 850/900/1800/1900Mhz
GPS Module	latest GPS SIRF-Star III chipset
GPS Sensitivity	-158Db
GPS Frequency	L1, 1575.42 MHz
C/A Code	1.023 MHz chip rate
Channels	20 channel all-in-view tracking
Position Accuracy	10 meters, 2D RMS
Velocity Accuracy	0.1 m/s
Time Accuracy	1 us synchronized to GPS time
Default datum	WGS-84
Reacquisition	0.1 sec., average
Hot start	1 sec., average
Warm start	38 sec., average
Cold start	42 sec., average
Altitude Limit	18,000 meters (60,000 feet) max.
Velocity Limit	515 meters/second (1000 knots) max.
LED	2 LED lights to show GPS/GSM working status.
Flash Memory	8MB
Interface	5 digital inputs, 3 negative and 2 positive triggering; 2 analog inputs; 5 outputs.

4 Getting Started

This section will describe how to set up your VT310.

4.1 Hardware Features

VT310 includes:

- *VT310 Main Unit*



- *GPS Antenna*
- *GSM Antenna*
- *Wires*
- *USB Cable with converter*

- CD including
 - User Manual
 - Other document or software if required

4.2 Light and Button Functionality

Blue LED - indicating GPS status	
On	One or more inputs are active
Flashing (every 0.1 second)	The unit is being Initialized
Flashing (on for 0.1 second and off for 2.9 seconds)	VT310 has a GPS fix
Flashing (on for 1 second and off for 2 seconds)	VT310 has no GPS fix
Green LED - indicating GSM status	
On	One call is coming in/ one call is being made
Flashing (every 0.1 second)	The unit is being Initialized
Flashing (on for 0.1 second and off for 2.9 seconds)	VT310 is connected to the GSM network
Flashing (on for 1 second and off for 2 seconds)	VT310 is not connected to the GSM network

SOS Button	Press it to send SMS alert
------------	----------------------------

4.3 Connecting and Installation

Read this manual before using your VT310 and check if all parts are included in the packaging box.

Ensure that your VT310 has a working SIM installed.

- Check that the SIM has not run out of credit (test the SIM in a phone to make sure it can send and receive SMS)
- Check that the SIM Lock code is turned off
- If you require the function of sending an SMS location report to the authorized phone number when it makes a call to the VT310, please make sure the SIM installed supports displaying caller ID.

Before inserting SIM card, cut off the power for the AVL unit.

Install SIM Card

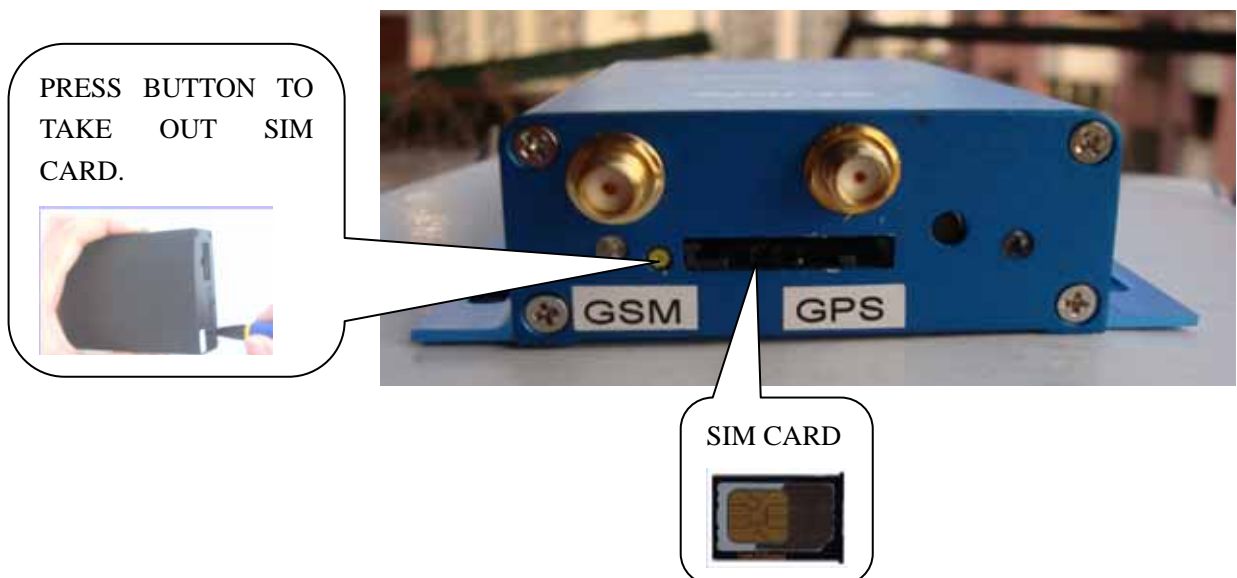

Insert the SIM card by Pressing the yellow hole ,the sim-card receiver will go outside automatically
 -inset the sim-card



Connect the GSM Antenna to the unit.
 Connect the GPS Antenna to the unit.

- GPS antenna is used to receive satellite signals in the sky. It should be fixed to face the sky and should not be covered or shielded by any objects containing metal, such as the metallic windshield.

Find a suitable place inside the car for installing the unit. Wiring connections must be firm and reliable and the joints should be wrapped with insulating tape tightly. The unused electrical wire should be properly insulated.

Check if all wirings have been connected correctly and then connect the unit to



the motor power.

A connector for microphone is set in the PCB. If you need to link with an extra microphone for wiretapping purpose, contact us to add this optional function before we deliver the devices to you.

Installation Guide:

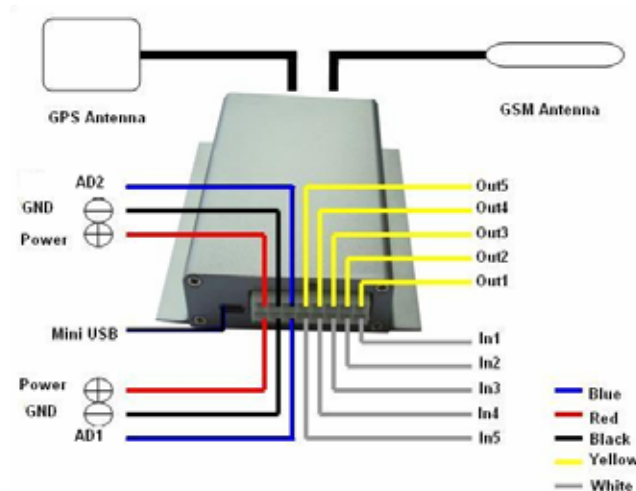

Descriptions of PINs

Pin	Color	Function
1	Red	DC In. Input voltage: 9V~35V. 12V suggested.
2	Black	GND

3	White	Digital Inputs
4	Yellow	Outputs
5	Blue	10 Bits Resolution Analog Inputs. Input voltage: 0~6V.

Mini USB Port

Connect the tracker with computer by USB cable for configuration and reading stored waypoints data. You need to install the driver - **PL-2303 Driver Installer** - for using the USB cable.



Refer to <GPS Tracker Parameter Editor> for configuration and <GPSLog User Guide> for reading stored waypoints.

4.4 Examples of Interfacing Application

For Input Ports

1. SOS Button - Input 1 / Input 2 / Input 3

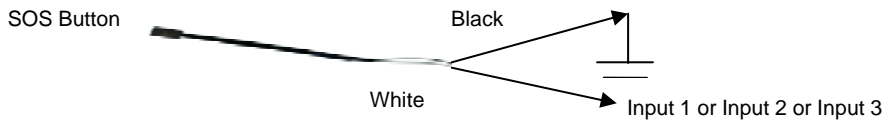

2. Ignition Detection - Input 4 / Input 5

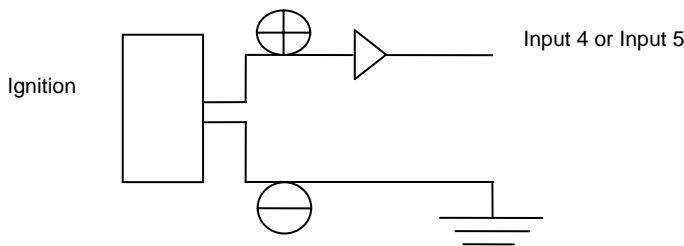

3. Detecting Lock Status of Car's Door or Trunk(Car Boot): Locked or Unlocked - Input 4 / Input 5

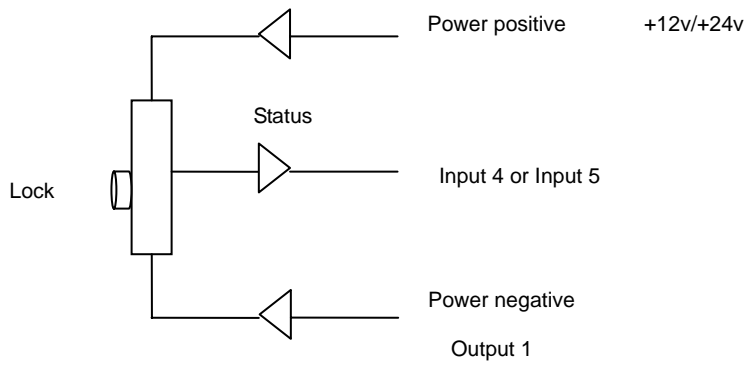

4. Connecting with Sensors (such as weight sensor) - Input 2 / Input3

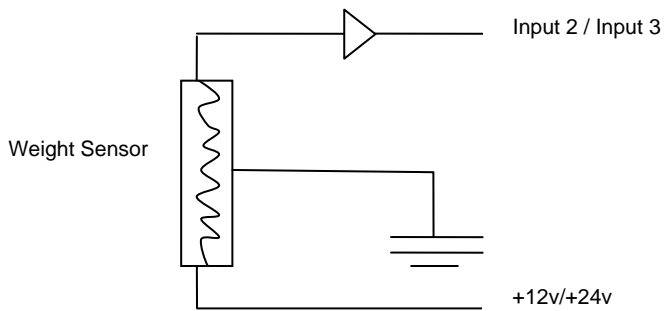

For Output Ports

1. Engine Cut

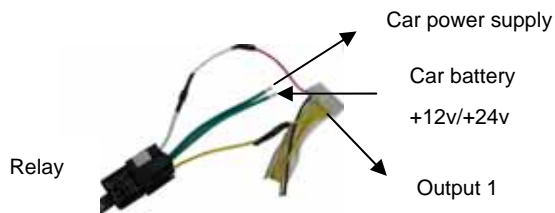

2. Connecting with Car Alarm

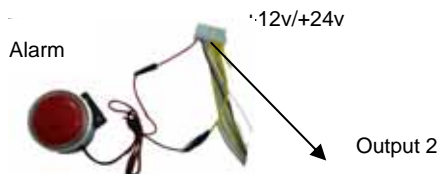

For Analog Input



5 SMS Command

VT310 will only accept commands from a user with the correct password. Commands with wrong password are ignored. The default password is 000000.

5.1 Basic SMS Commands

5.1.1 Position Report

To know the location of your VT310, send an SMS or make a telephone call directly to VT310 and it will report its location by SMS.

Command: W<password>,<000>

Notes: The default password is 000000.

Example:

SMS sent: W000000,000

SMS received:

Latitude = 22 32 36.63N Longitude = 114 04 57.37E, Speed = 2.6854Km/h, 2008-12-24,01:50

To get VT310's position by another easier way:

- (a) Call VT310 using your mobile phone.
- (b) After listening to the ring for 10 - 20 seconds, hang up the phone.
- (c) Then after 20 second, your mobile phone will receive a position SMS.

5.1.2 Set Interval for Automatic Timed Report

Description: Automatic timed reports will be sent to your mobile phone according to the time interval you set.

Command: W<password>,002,XXX

Notes: XXX is the interval in **minute**. If XXX=000 it will stop tracking

Example:

SMS sent: W000000,002,005

SMS received: Set Timer Ok/005

VT310 will then report its location by SMS every 5 minutes.

5.1.3 Stop Automatic Timed Report

Description: Automatic timed reports will stop once VT310 receives stop command.

Command: W<password>,002,000

Example:

SMS sent: W000000,002,000

SMS received: Set Timer Ok/000

VT310 will stop automatic timed report

For more detailed SMS commands please go to Chapter 8 - SMS Command List

5.2 GPRS Settings by SMS

Tracking via GPRS, you should set IP, Port and APN for VT310.

Ensure that your SIM card in VT310 supports GPRS connection prior to setting.

5.2.1 Set ID for VT310

Command: W<password>,010,ID

Note: Tracker ID must not over 14 digits.

Example: W000000,010,123456789

VT310 will then reply with an SMS ('Set SIM Ok/123456789') to confirm this setting.

5.2.2 Set APN

Command: W<password>,011,APN,APN Name,APN Password

Note: If no APN name and password required, input APN only.

Example: W000000,011,CMNET

VT310 will reply with an SMS (like 'Set APN Ok/CMNET') to confirm this setting.

5.2.3 Set IP Address and Port

Command: W<password>,012,IP,PORT

Example: W000000,012,202.116.11.12,8000

VT310 will then reply an SMS ('Set IP Ok /202.116.11.12,8000') to confirm this setting.

5.2.4 Set Time Interval for Sending GPRS Packet

Command: W<password>,014,time interval(in unit of 10 seconds)

Example: W000000,014,00003

VT310 will send GPRS packet every 30 seconds

5.2.5 Enable GPRS Tracking Function

Command: W<password>,013,X

X=0, to turn off GPRS tracking function (default);

X=1, to set TCP

X=2, to set UDP

Example: W000000,013,1

VT310 will reply with an SMS to confirm this setting.

For more information regarding of bulk configuration by USB cable please refer to < GPS Tracker Parameter Editor>.

For more information regarding GPRS settings please refer to <GPRS Communication Protocol >.

If you are using GpsGate Software, please contact us for writing GpsGate protocol before delivery.

6 Tracking on Map

Download Google Earth from <http://earth.google.com/>

Start the Google Earth (For more information about Google Earth please refer to <http://earth.google.com/>)

as the following picture shows:

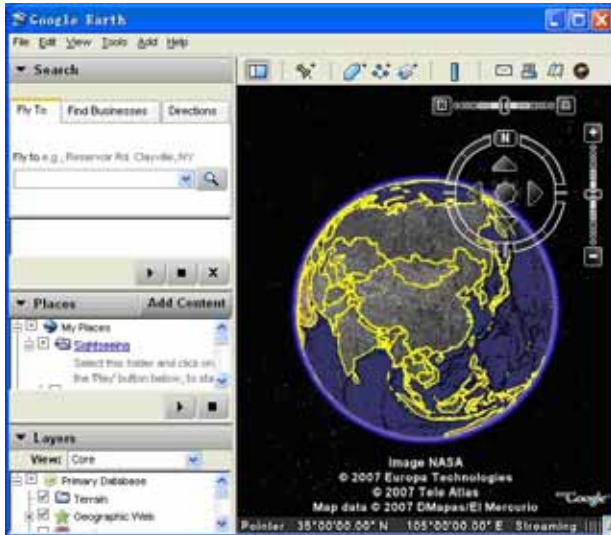

Input the latitude and longitude that you receive from the tracker by SMS and click the search button. Google Earth will display the location for you.

Example:

When you receive:

Latitude = 22 32 40.05N

Longitude = 114 04 57.74E

Type as the following picture shows:

(Note: you should input the latitude and longitude as: 22 32 40.05N 114 04 57.74E)



Now you can find the location of your tracker:

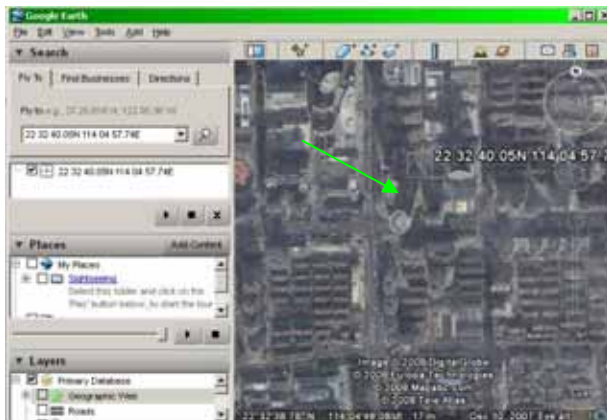

Or you can start the Internet Explorer and connect to <http://maps.google.com> for displaying the location.

Or you can use local map software on PDA or car navigation device to input the coordinates.

7 Troubleshooting

Problem: Unit will not turn on	
Possible Cause:	Resolution:
Wiring was not connected properly	Check and make sure wiring connection is in order.
Battery needs charging	Recharge battery
Problem: Unit will not respond to SMS	
Possible Cause:	Resolution:
GSM antenna was not installed properly	Make VT310 connected to GSM network.
GSM Network is slow	Wait for SMS. Some GSM networks slow down during peak time or when they have equipment problems.
Unit is sleeping	Cancel sleeping mode
Wrong password in your SMS or wrong SMS format	Write correct password or SMS format
The SIM in VT310 has run out of credit	Replace or top up the SIM card
No SIM card	Insert working SIM card. Check in phone that the SIM can send SMS message.
SIM card has expired	Check in phone that the SIM can send SMS message. Replace SIM card if needed.
SIM has PIN code set	Remove PIN code by inserting SIM in you phone and deleting the code.
SIM is warped or damaged	Inspect SIM, clean the contacts. If re-inserting does not help try another to see if it will work.
Roaming not enabled	If you are in a different country your SIM account must have roaming enabled.
Problem: SMS received starts with 'Last...'	
Possible Cause:	Resolution:
Unit does not have clear view of the sky	Move the antenna of the unit to a location where the sky is visible.
VT310 is in an inner place	Wait for the target to come out
Battery is low	Recharge the unit and the GPS will start working.

8 SMS Command List

(Remarks: ***** is user's password, and the default password is 000000)

Description	Command	Remarks
Get current location	W*****,000	Get current location of VT310
Change user's password	W*****,001,#####	***** is old password ##### is new password
Set interval for automatic timed report	W*****,002,XXX	XXX is the interval in minute. If XXX=000 it will stop tracking
Set preset phone number for SOS button	W*****,003,F,P,T	F=0, to turn off this function; F=1, to send SMS; As SOS button is linked to IN1, P=1. T: Preset phone number. Max 16 digits
Set low power alert When VT310 voltage is lower than the preset value, it will send one low power alert to the SOS preset number.	W*****,004,X	X (voltage preset value) =0 , to turn off this function =1 , <3.3V send SMS alert =2 , <3.4V send SMS alert =3 , <3.5V send SMS alert (default) =4 , <3.6V send SMS alert =5 , <3.7V send SMS alert
Set over speed alert When VT310 speeds higher than the preset value, it will send an SMS to the SOS preset number.	W*****,005,XX	XX (the preset value of speed) =00 , to turn off this function =[01, 20] (unit: 10Km/h) For example, W000000,005,08, it will sent alert when it is over 80Km/h
Set Geo-fence alert When the VT310 moves out of preset scope, it will send one Geo-fence SMS to the SOS preset number.	W*****,006,XX	XX (preset distance to original place) =00, close =01, 30m =02, 50m =03, 100m =04, 200m =05, 300m =06, 500m =07, 1000m =08, 2000m

<p>Extend Settings</p>	<p>W*****,008,ABCDEFGF###</p>	<p>A=0, turn off the function of sending an SMS location report to the authorized phone number when it makes a call to VT310.</p> <p>A=1, turn on the function of sending an SMS location report to the authorized phone number when it makes a call to VT310.</p> <p>B=0, location data of NMEA 0183 GPRMC will be interpreted into normal text for easy reading.</p> <p>For example: <i>Longitude = 114 degree - 04 cent -57.74 second</i> <i>Latitude = 22 degree -32 cent -40.05 second</i></p> <p>B=1, location data complies with NMEA 0183 GPRMC protocol.</p> <p>For example: <i>\$GPRMC,072414.000,V,3114.3763,N,12131.3255,E,0.00,0.00,050805,*00</i></p> <p>C=0, turn off the function to automatically hang up an incoming call.</p> <p>C=1, turn on the function to automatically hang up an incoming call after 4 - 5 rings.</p> <p>D=0, Turn off the function of sending an SMS when VT310 is turned on.</p> <p>D=1, Turn on the function of sending an SMS to SOS number when VT310 is turned on.</p> <p>E=0, reserved</p> <p>E=1, VT310 shuts down automatically when the power voltage lower than 3V.</p> <p>F=0, Turn off the alert when VT310 enters GPS blind area.</p> <p>F=1, Turn on the alert when VT310 enters GPS blind area. SMS is to be sent to SOS number</p> <p>G=0, LED light works normally</p> <p>G=1, LED light stops flashing when VT310 working.</p> <p>### is the ending character (default value is: ABCDEFG=1000100)</p>
-------------------------------	-------------------------------	---

Presetting by SMS for GPRS tracking (Ensure that your SIM card supports GPRS connection prior to setting)		
Set ID for VT310	W*****,010,ID	Tracker ID must not over 14 digits.
Set APN	W*****,011,APN,APNName,APN Password	If no APN name and password required, just insert APN only; APN defaulted as 'CMNET'; APN + APN name + password not over 39 characters.
Set IP Address and Port	W*****,012,IP, Port	IP: xxx.xxx.xxx.xxx Port: [1,65534]
Enable GPRS Tracking Function	W*****,013,X	X=0, close GPRS (default); X=1, enable TCP X=2, enable UDP
Set Time Interval for Sending GPRS Packet	W*****,014,XXXXX	XXXXX should be in five digitals and in unit of 10 seconds. XXXXX=00000, to close this function; XXXXX=00001~65535, time interval for sending GPRS packet and in unit of 10 seconds.
For more information regarding GPRS settings please refer to <GPRS Communication Protocol>		
Output Control	W*****,020,P,F	P =1, Out1 =2, Out2 =3, Out3 =4, Out4 =5, Out5 F =0, to close the output =1, to open the output
Output Control (Safe mode) This function is achievable when the speed is below 10km/h and GPS is available.	W*****,120,ABCDE	ABCDE represents Out1, Out2, Out3, Out4, and Out5 respectively. If A or B or C or D or E, =0, to close the output =1, to open the output =2, to remain previous status
Set sleep mode for saving power	W*****,021,XX###	XX=00 turn off sleep mode XX=01 sleep mode XX=02 deep sleep mode ### is the ending character
Set power saving mode when VT310 is inactive (In power saving mode, GPS stops working. GSM enters standby mode and stop sending out message until it is activated by an SMS or an incoming call)	W*****,026,XX	XX=00, to turn off this function XX=01~99, to set this function. It is in unit of minute. Example: If XX=10, VT310 will enter power saving mode after it is immobile for 10 minutes.

Set phone number for wiretapping	W*****,030,T	T is the telephone number for wiretapping and max. 16 digits
Set interval for logging <i>(Note: this interval is not relevant to the interval of continuous tracking)</i>	W*****,031,X	X=0, to turn off this function X=[1, 65535] to set interval in second. For example, W000000,031,60, VT310 will store location data every 60 seconds.
Set time zone difference	W*****,032,T	T=0, to turn off this function T=[1, 65535] to set time difference in minute to GMT. Default value is GMT For those ahead of GMT, just input the time difference in minute directly. For example, W000000,032,120 '-'is required for those behind GMT. For example, W000000,032,-120.
Set character for SOS alert message	W*****,033,1,Char	Char is the character in SOS message and max 32 characters
Get version and serial number	W*****,600	To get version and serial number of current firmware
Get IMEI	W*****,601	To get IMEI