

Electronic Code Lock

SL2000E v1.2

Rev.A

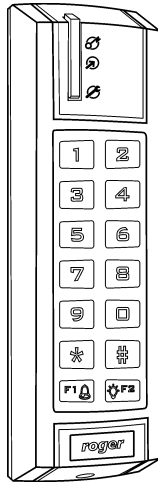

Features

- Door Relay output
- **Status** transistor output
- **Aux** transistor output
- Door Contact input
- Exit Button input
- **INSTALLER** code for programming
- **MASTER** code for arming/disarming
- **USER** codes for door opening
- **Door Alarm** indication
- Option: **Timed Lock-out** after three wrong codes
- Option: **Access only when Disarmed**
- Programmable length of codes
- User indexing for easy administration of codes
- Nonvolatile memory
- Keypad with backlight
- Door Bell key
- Three LEDs and buzzer
- **Tamper** contacts
- Outdoor operation (IP65)

roger

Introduction

The SL2000E electronic code lock is designed for operation as a indoor/outdoor stand-alone door access control unit. The device is equipped with one relay output, two transistor outputs and two NO inputs. All codes and parameters configuring the device's operation are stored in nonvolatile memory.

Functional Description

Note: The *C1, C2...C10* parameters which appear in this manual refer to configuration settings programmed to the SL2000 during *Memory Reset* procedure (see section: *Configuring the SL2000* later in this document).

Door Relay Output

This output is designed to control a door locking device (e.g. door strike or magnetic lock). Each time the valid USER code is entered the SL2000 starts counting time delay specified by *C1C2* parameters and after it elapses the relay output is activated for a time defined by *C3C4* value. The triggering of the *Door Relay* output is indicated by LED OPEN (green), this LED lights up as long as *Door Relay* output is on.

Note: If the option *Disable Access in Armed Mode* is enabled the activation of the *Door Relay* output may occur only when the unit operates in the *Disarmed mode*.

Status Output

When the SL2000 is in *Armed* mode this output is not active and remains in high resistance condition. When code lock switches to *Disarmed* mode the Status output shorts to supply minus (GND) and stay in this condition as long as the SL2000 operates in the *Disarmed* mode. The maximum current sink by this output is internally limited to 1.0A, the maximum voltage applied to it must not exceed 16V DC. The *Status* output can be used for rearming of an alarm zone or to control any other device or system which requires *on/off* method of control.

Note: The arming and disarming of a code lock can be carried out by MASTER code only.

Aux Output

Normally this output remains in high resistance state, if triggered it shorts to supply minus (GND). The *Aux* output has been designed to indicate two situations:

- *Door Bell* event
- *Door Alarm* event

Whenever the *Bell* key is pressed for a moment or the [#] key is pressed and held down longer than half a second, the *Aux* output goes steady on (shorts to supply minus), the *Aux* output remains in this condition as long as the *Bell* or [#] key is being pressed.

The *Aux* output can be also activated when *Door Alarm* is active. The code lock indicates the *Door Alarm* through pulsed modulation of the *Aux* output. Thanks to this feature (steady or pulsed output) operator may distinguish the *Bell* signal from the *Door Alarm*.

The maximum current sink by this output is internally limited to 1.0A, the maximum voltage applied to it must not exceed 24V DC. Normally the *Aux* output is used to trigger some kind of warning device (e.g. alarm siren or buzzer).

Note: The *Door Alarm* has higher priority than the *Door Bell* event. As a result when two of those events occur simultaneously only the *Door Alarm* is indicated on the output line.

Exit Button Input

Triggering of this input activates *Door Relay* output on the same rules as the entry of a valid USER code. The *Exit Button* is a NO type – it becomes triggered when shorted to supply minus (GND).

Door Contact Input

This input is dedicated for a connection of a door open sensor. When input is open or left unconnected the code lock assumes that door is closed, when input is shorted to supply minus (GND) the SL2000 assumes that door is open.

Note: If you are not going to use a door open sensor leave the *Door Contact* input unconnected. Without a door open sensor the SL2000 will not indicate the *Door Open* alarm.

LED System Input

This input is dedicated to control the LED SYSTEM (orange), shorting this input with supply minus lights up LED SYSTEM. The LED SYSTEM can be use to any purpose required by installer (e.g. to indicate actual status of the alarm system).

Door Open Alarm

The *Door Open* alarm will occur when:

- door has been opened without entering of a valid USER code
- door has been opened without pressing of the *Exit Button*
- door has not been closed within *C5C6* time from the moment when door locking device was deactivated

The *Door Open* alarm is indicated by pulsed activation of the *Aux* output which is accompanied by a continues acoustic signal generated by the internal buzzer. Pressing any key will cease the acoustic signal – however this does not cancel the alarm indication on *Aux* output. The indication on the *Aux* output disappears when door becomes closed or automatically after 60 seconds from the moment when alarm arose.

Option 1: Timed Lock-out

If this option is enabled the lock disables the keypad for 60 seconds after three attempts of entry of incorrect code. After this time the SL2000 re-enables the keypad and is ready to accept new keypad's entries. The end of 60 seconds lock-out time is indicated by two series of two beeps (** **).

Option 2: Disable Access in Armed mode

If this option is enabled the SL2000 grants access to a room only when it operates in *Disarmed* mode. With this option active the access to the controlled door will be disabled for both all USER codes and *Exit Button* unless the SL2000 will be switched to *Disarmed* mode.

Note: Thanks to this option the MASTER user can disable access to the room by switching the unit to *Armed* mode and vice versa, he can enable access to controlled door by switching the code lock to *Disarmed* mode. The SL2000 can be switched between *Armed* and *Disarmed* modes through the MASTER code only.

Arming and Disarming of the Code Lock

In normal operation mode the SL2000 may work either in the *Armed* or *Disarmed* mode. The *Armed* mode is signalled by LED ARMED (red) whereas the *Disarmed* mode is signalled by LED DISARMED (green). The actual operating mode of a lock is also indicated on the *Status* output line which when active indicates that unit is *Disarmed*. The switching between *Armed* and *Disarmed* modes can be carried out by MASTER code only. Whenever code lock switches to *Disarmed* mode is generates two series of two beeps (** **) whereas when switches to *Armed* mode it generates two beeps (**) only.

Codes

The SL2000 offers three types of codes:

- MASTER Code
- INSTALLER Code
- USER Codes

Each type of code is designed for individual purpose. The length of each code can be programmed during *Memory Reset* procedure. The entry of each code must be followed by the [#] key which is used to mark the end of a code.

MASTER Code

The MASTER code is used to switch the SL2000 between *Armed* and *Disarmed* modes, it can be 4-10 digits long.

INSTALLER Code

The INSTALLER code is required to enter the *Installer Programming* mode, it can be 4-10 digits long.

USER Codes

These codes are used for activation of the *Door Relay* output. Each time a valid USER code is entered the SL2000 starts counting *C1C2* time delay and then when it passes by the unit activates *Door Relay* output. The *Door Relay* output is activated for time defined by *C3C4* settings. The USER codes can be 2-8 digits long.

Note: The SL2000 enables programming of maximum 55 USER codes, each of them can open the door.

Commands

Commands can be entered during normal working time of a SL2000 code lock and doesn't require entry to the programming mode.

[USER Code] [#]

Whenever a valid USER code is entered the code lock generates two beeps (**) and then starts count *C1C2* time delay. After it passes by the SL2000 activates *Door Relay* output for time defined by *C3C4* settings. During this time door locking device is energized and user can open the door.

[MASTER Code] [#]

Each time the MASTER code is entered the SL2000 changes its arming mode (switches from *Armed* to *Disarmed* mode or in reverse direction).

[INSTALLER Code] [#]

After this command code lock generates two beeps (**) and enters the *Installer Programming* mode. In this mode installer can program the USER codes to a unit.

[*] [Old INSTALLER Code] [#] [New INSTALLER Code] [#]

This command erases the old INSTALLER code and program new INSTALLER code. If command is successfully accomplished the unit generates three series of two beeps (** ** **).

[*] [Old MASTER Code] [#] [New MASTER Code] [#]

This command erases the old MASTER code and program new MASTER code. If command is successfully accomplished the unit generates three series of two beeps (** ** **).

Note: Whenever you re-program MASTER or INSTALLER code remember that new code programmed into a unit must have the same length as the old one.

[Bell Key]

A single short press of this key activates the *Aux* output and internal buzzer for a time of ~2...3 seconds. The indication on *Aux* output and buzzer is continued for entire time as long as *Bell* key is being pressed.

[#]

Normally it marks the end of a code but when pressed separately for a time longer the 0.5s it acts in the same way as *Bell* key.

Programming of the USER Codes

The SL2000 enables programming of up to 55 different USER codes. The USER codes can be managed (added/deleted/changed) only in the *Installer Programming* mode. In order to program the USER codes you must first enter the *Installer Programming* mode and then you have access to the programming commands listed below:

- [0] [1] [#] [code] [#]** - Programming of the USER code no. 1
- [0] [2] [#] [code] [#]** - Programming of the USER code no. 2
- [0] [3] [#] [code] [#]** - Programming of the USER code no. 3
- ...etc.
- ...etc.
- ...etc.
- [5] [5] [#] [code] [#]** - Programming of the USER code no. 55
- [0] [0] [#]** - Delete all USER codes
- [9] [9] [#] [code] [#]** - Deletes the code entered in square brackets



[#] - Exit from the Installer Programming mode

When the code lock accepts the new USER code it generates two series of two beeps (** **). Any attempt to program a USER code which already exists in memory or to program it with a code length bigger then programmed during *Memory Reset* will cause the programming error signalled by the long acoustic beep.

Configuring the SL2000 (Memory Reset)

In order to configure the SL2000 you must perform the *Memory Reset* and then enter sequentially 10 digits (called *C1-C10*) which will configure the unit for individual installation. After the *Memory Reset* the entire contents of the code lock memory is erased (including all codes) and initialized with *Default (Factory)* settings. These values

In order to perform *Memory Reset* do the following steps:

- Turn off the power supply
- Connect *Reset* wire (Brown-Yellow) to supply plus
- Turn on the power supply
- Wait till the moment when device will sound three series of two beeps (** ** **) - this signal indicates that SL2000 erased memory and restored default configuration settings
- Disconnect *Reset* wire (Brown-Yellow) from supply plus
- Enter sequentially ten digits C1-C10
- After the last digit is entered the code lock generates the three series of two beeps (** ** **) then ends the *Memory Reset* procedure and switches to normal working mode.

Meaning of the configuration parameters: C1-C10

C1C2: *Open Delay*, specifies the time delay from a moment when access is granted to a moment when *Door Relay* will be activated. It can be programmed from 00 to 99s (default: 04).

C3C4: *Lock Activation Time*, specifies the time for which *Door Relay* will be activated when access is granted. It can be programmed from 00 to 99s (default: 04).

C5C6: *Time for Door Closing*, specifies the time within which door must be closed. It can be programmed from 00 to 99s, the 00 value sets unlimited time for closing (default: 09).

C7: Enables or disables of reprogramming of the MASTER and INSTALLER codes, enter 0-3 (default: 0).

Value	Reprogramming of the MASTER code	Reprogramming of the INSTALLER code
0	Enabled	Enabled
1	Disabled	Enabled
2	Enabled	Disabled
3	Disabled	Disabled

Note: If *reprogramming* of a given code is disabled the SL2000 allows you a single attempt only to program of the given code. Once the code is programmed, you will not be able to change it unless the *Memory Reset* is carried out. Use this function to disable the end user to change your MASTER and INSTALLER code

C8: Enabling and disabling *Option 1* and *Option 2*, enter 0-3 (default:0).

Value	Option 1	Option 2
0	Disabled	Disabled
1	Enabled	Disabled
2	Disabled	Enabled
3	Enabled	Enabled

Option 1: Timed Lock-out

Option 2: Disable USER Codes When in Armed Mode

- C9:** Defines the length of the USER codes, enter 0-3, (default: 1).
- 0 : USER codes are 2 digits long
 - 1 : USER codes are 4 digits long
 - 2 : USER codes are 6 digits long
 - 3 : USER codes are 8 digits long
- C10:** Defines the length of the *MASTER* and *INSTALLER* codes, enter 0-3, (default: 1).
- 0 : Both codes are 4 digits long
 - 1 : Both codes are 6 digits long
 - 2 : Both codes are 8 digits long
 - 3 : Both codes are 10 digits long

If an illegal operation occur during *Memory Reset* the device will signal an error (long beep) and will return to the beginning of the programming so you can start to enter the *C1-C10* digits once again. The *Memory Reset* procedure automatically comes to an end when the last (*C10*) digit is entered. The device stores the configuration as well as all codes in a nonvolatile memory which can be reprogrammed whenever required. After the *Memory Reset* procedure comes to an end all codes are set to default values (see section *Default Codes*).

Example:

The following digits C1-C10 were entered during the Memory Reset procedure: [0][1][0][2][3][3][1][0][2][3]

This sequence sets the following options:

- *Open Delay: 01 second*
- *Lock Activation Time: 02 seconds*
- *Time for Door Closing: 33 seconds*
- *Reprogramming of the MASTER code: disabled*
- *Reprogramming of the INSTALLER code: enabled*
- *Option 1; Timed Lock-out : option off*
- *Option 2; Disable Access in Armed Mode: option off*
- *USER codes: 6 digits*
- *MASTER and INSTALLER codes: 10 digits*

Default Codes

After the *Memory Reset* is accomplished the following codes are automatically programmed into a unit:

MASTER Code

All digits are "1" (1111...), the length of the code depends on the *C10* parameter entered during *Memory Reset* procedure.

INSTALLER Code

All digits are "2" (2222...), the length of the code depends on the *C10* parameter entered during *Memory Reset* procedure.

USER Code no 01

All digits are "3" (3333...), the length of the code depends on the *C9* parameter entered during *Memory Reset* procedure.

USER Code 02..55

All USER codes no 02 -55 are blank (they doesn't exist).

Installation

- The SL2000 code lock should be mounted near the supervised door on a vertical piece of supporting structure.
- Assure that the surface beneath of the controller's rear panel is flat and smooth.
- Disconnect power supply before making any electrical connections.
- Once installed and electrically connected, the unit has to be properly programmed.
- When forgotten, MASTER and INSTALLER codes can be reprogrammed through *Memory Reset* procedure.
- The code lock must be supplied form reliable power supply, calculate the adequate wire gauge to guarantee that the voltage dropout between the power supply and the DC input of SL2000 will not exceed 1V in the worst case.
- It is recommended to supply door release device (e.g. door strike or magnet lock) and SL2000 from separate power supply but when both code lock and door release device are supplied from the same power source you must use separate pairs of cable to supply each of them.
- Always add the silicon diode (e.g. 1N400x series) in parallel to door release device – locate diode as close as possible to door release and as far as possible from the code lock.
- It is forbidden to supply the door release device directly from the DC input terminals of a code lock.
- Do not attempt to use Door Relay output for switching of a voltages higher then 24V DC/AC.

SL2000E v1.2 - Typical Wiring Diagram

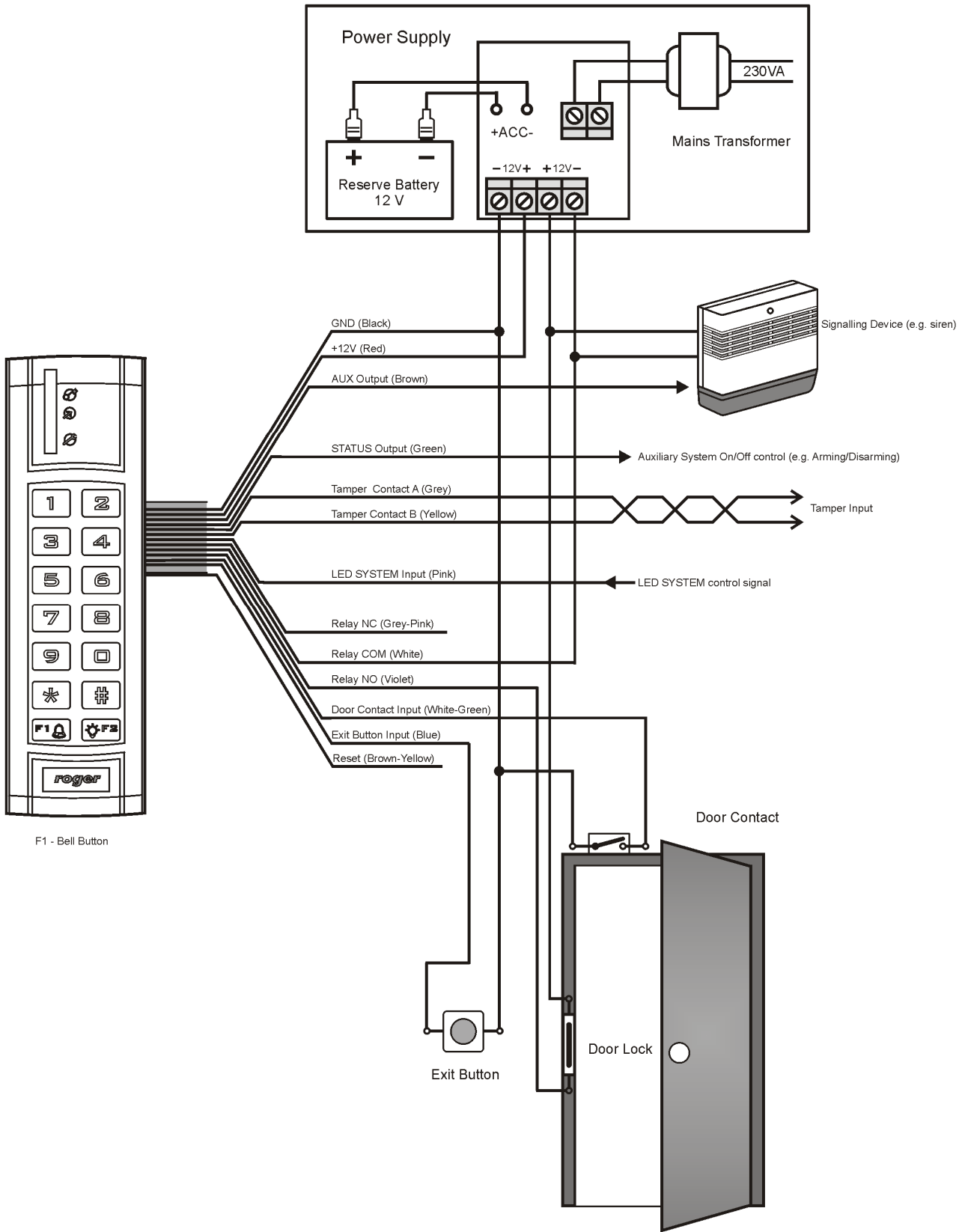

cdr179p4

SL2000E v1.2 Code Lock
Views and Installation Diagram

-  LED STATUS
-  LED OPEN
-  LED SYSTEM

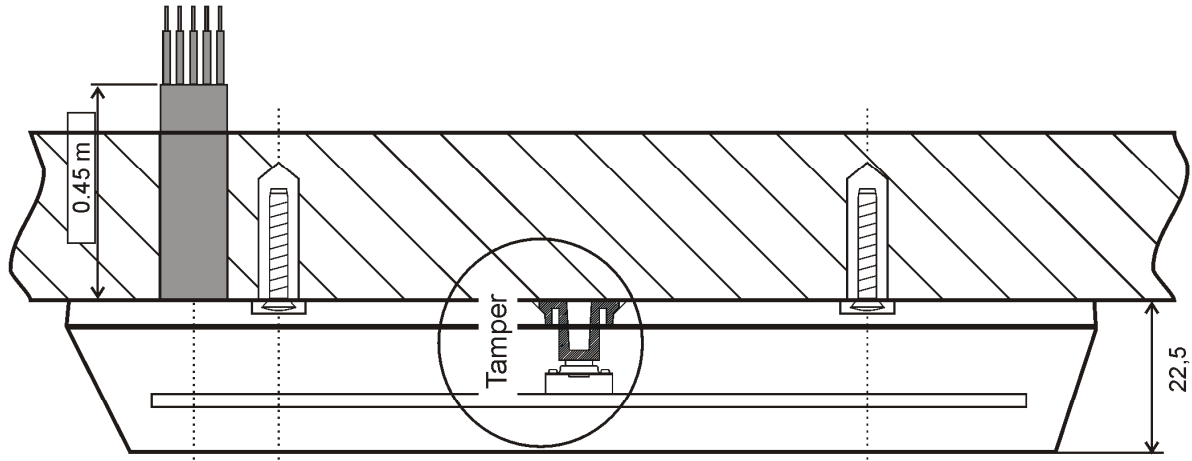
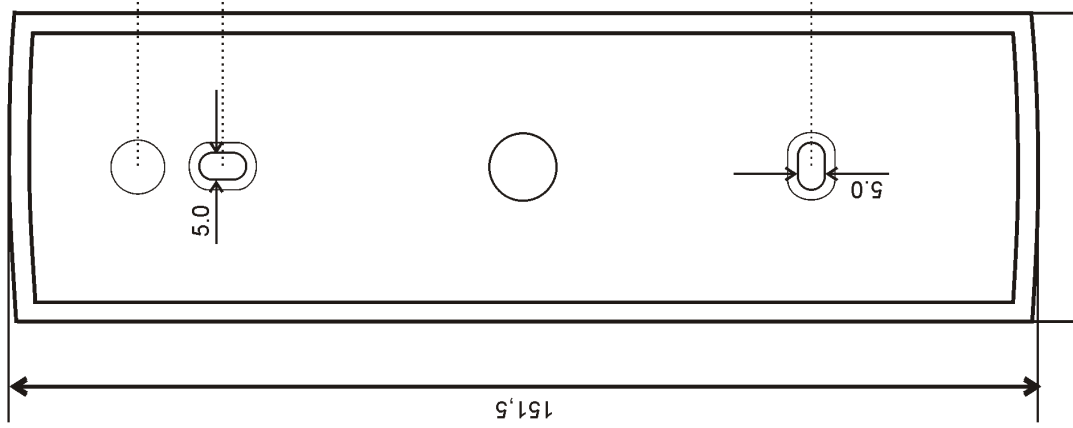
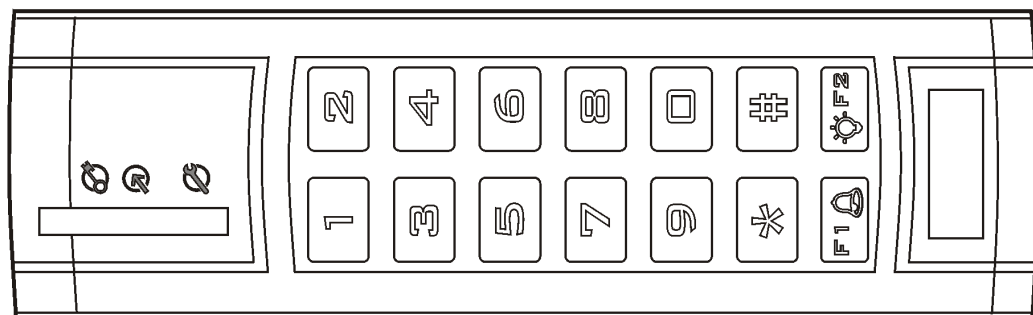
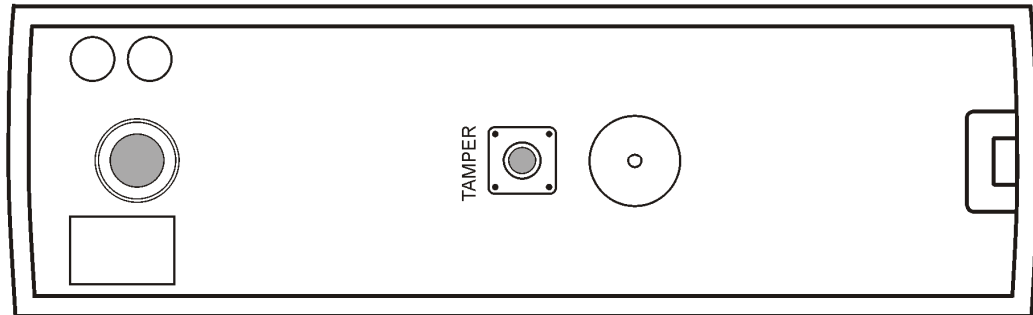

Technical Specification

Parameter	Value
Supply	10...16 VDC
Current consumption	Avg. 25 mA @ 12V DC, Max. 80 mA @ 16V DC with relay output active
Anti-sabotage protection (Tamper)	NC contact, 50mA/24V
Environmental Class (according to EN 50131-1)	Class IV, Outdoor-General, Temp.: -25°C +60°C Relative humidity: 10 - 95% (non-condensing)
Ingress protection	IP65
Connection cable length (for SL2000F-VP)	45cm
Dimensions	100 X 40 X 25
Weight	~ 150g
Approvals	CE

Connection Terminals Assignments

Label	Wire colour	Description
+12V	Red	Supply input plus
GND	Black	Supply input minus
Status Output	Green	Status transistor output, max. current sink 1.0A/16V DC
AUX	Brown	Aux transistor output, max. current sink 1.0A/16V DC
TMP A	Grey	Tamper contact A, NC max. 50mA/24V
TMP B	Yellow	Tamper contact B, NC max. 50mA/24V
Exit Button	Blue	Exit Button input, NO type
Door Contact	White-Green	Door Contact input, NO type, 1.5A/24V DC/AC
LED SYSTEM	Pink	NO input, when shorted with supply minus LED SYSTEM becomes active
COMM	White	Door Relay output, COMMON contact, 1.5A/24V DC/AC
NO	Violet	Door Relay output, NO contact, 1.5A/24V DC/AC
NC	Grey-Pink	Door Relay output, NO contact, 1.5A/24V DC/AC
Reset	Brown-Yellow	User for memory reset

Ordering Information

Item	Description
SL2000F	Dark grey plastic enclosure, screw connection terminals, indoor installation only
SL2000F-VP	Vandal proof, metal front cover and keys, silver color, pig tail connection cable, outdoor installation available

Product History

Version	Firmware	Date	Description
SL2000F v1.0	N/A	16/11/2009	Initial release of the product
SL2000F-VP v1.0	N/A	16/11/2009	Initial release of the product

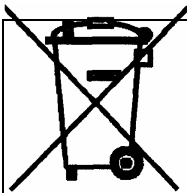

The symbol of a crossed-through waste bin on wheels means that the product must be disposed of at a separate collection point. This also applies to the product and all accessories marked with this symbol. Products labeled as such must not be disposed of with normal household waste, but should be taken to a collection point for recycling electrical and electronic equipment. Recycling helps to reduce the consumption of raw materials, thus protecting the environment.

Contact

Roger sp. j.

82-400 Sztum

Gosciszewo 59

Tel.: +48 55 272 01 32

Fax: +48 55 272 01 33

Technical support PSTN: +48 55 267 01 26

Technical support GSM: +48 664 294 087

e-mail: biuro@roger.pl