



FSM-1737 / FULL SWING

WALL MOUNT

For 17"-37" Flat Panel Screens

User Manual

Thank you for choosing Gabor.

Thank you for choosing Gabor's full swing flat panel screen wall mount. This heavy-duty wall mount has been engineered to provide your 17"-37" flatscreen monitor with sturdy, long-lasting support that can be relied upon for years of viewing enjoyment.

With an impressive lineup of versatile mounting brackets possessing various functionalities - along with a resilient, user-friendly mounting method that simplifies the installation process - Gabor's reputation for providing quality viewing solutions and long-lasting dependability is readily apparent...from every angle.



Product Specifications

- **For Mounting 17"-37"
Flat Panel Screens
On Wooden Studs &
Concrete Walls**
- **VESA Mounting
Pattern**
75/100/200
- **Maximum Load
Capacity**
66lbs/30kg

Tools Required For Installation

1. Power Drill
2. Phillips Screwdriver
3. Tape Measure
4. Socket Wrench

Product Contents

Supplied Parts & Hardware





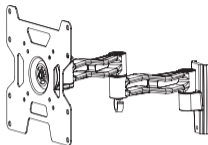







- | | |
|-----------------------------|--------------------------|
| A (4) M4 Lock Washer | G (4) Spacer M6 |
| B (4) M4 X 12 Bolt | H (4) Spacer M8 |
| C (4) M4 X 30 Bolt | I (2) Long Bolt |
| D (4) M6 Lock Washer | J (2) Lead Anchor |
| E (4) M6 X 12 Bolt | K (1) Hex Key S3 |
| F (4) M6 X 35 Bolt | L (1) Hex Key S4 |

Mounting Bracket



Wall Mount



M4	M6	Spacer	Long Bolt/ Lead Anchor	Hex Key
<p>A x4</p> 	<p>D x4</p> 	<p>G x4</p> 	<p>I x2</p> 	<p>K x1</p> 
<p>B x4</p> 	<p>E x4</p> 	<p>H x4</p> 	<p>J x2</p> 	<p>L x1</p> 
<p>C x4</p> 	<p>F x4</p> 			

Installation Instructions

STEP 1: Installing Dual Mounting Bracket On Rear Of Flatscreen

- Begin by separating mounting bracket arm from wall mount device. This can be accomplished by pressing and holding safety release latch found atop wall mount device; slide arm assembly upwards and away. Place wall mount device aside and extend arm of mounting bracket assembly in a vertical position.
- Continue by aligning mounting bracket with hole pattern on rear of flatscreen device, while ensuring that device screen is resting on a non-scratch surface. The appropriate bolts and washers should be selected by measuring the height, size and position of holes on rear of flatscreen device, and determining which bolts and washers fit best. This may vary according to specific brand, make and model of flatscreen device.
- Use the shortest configuration of bolts, washers and spacers for a secure fit. Spacers may or may not be required depending on curvature of flat screen device and rear dimensions. During hardware installation, ensure that extending arm does not wobble or flop around; take proper precautions to avoid damage or injury caused by extending arm.

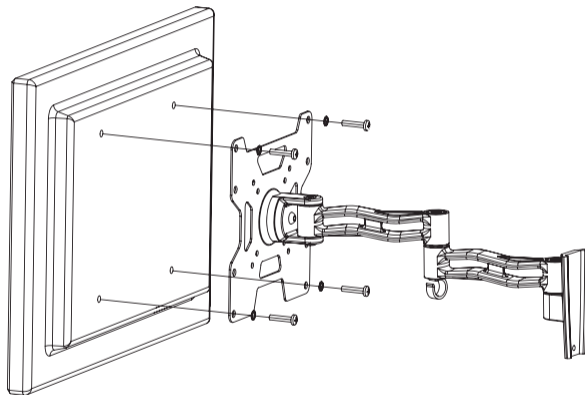

- Note that bolts must be hand-fastened into holes with a screwdriver to avoid overtightening and possible damage.

Hardware Configurations

For Display With Flat Back:

Install bracket directly to flatscreen device using only bolts and washers provided; align bolt with proper sized hole on washer. **(Fig. 1)**

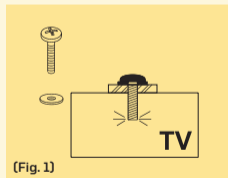

For Display With Curved Backs & Recessed Mountings:

Install appropriate sized spacer between bracket and flatscreen device; then fasten securely with bolts and washers. **(Fig. 2)**

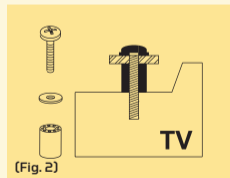

STEP 2: Positioning Mount Correctly On Wall

- The optimal height to position a flatscreen device is by mounting it at eye-level of viewer. This can be accomplished in one of two ways:

- Measure distance from seating area to viewing area to determine proper placement. The ideal position should place the center of the panel (where the diagonals meet) as close as possible to eye-level.

- For a simpler calculation, cut a piece of sturdy cardboard that's approximately the same size as flatscreen device and tape to wall; gaze at cardboard to determine if it is at a comfortable level; reposition the cardboard until it is sitting at a perfect height and mark location of cardboard on wall with a pencil

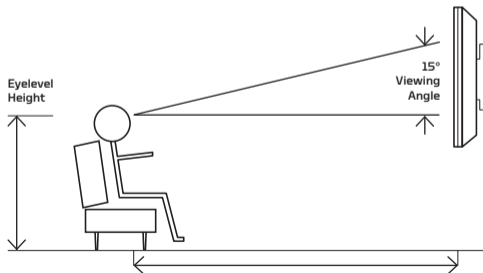

STEP 3:

Installing Mount Directly On Wall

- After confirming height positioning is appropriate by marking wall with a pencil, hold wall mount firmly against wall and use pencil to mark exact location of drill holes, using built-in leveler to ensure a proper balance; then remove wall mount and pre-drill holes (see sidebar for specific mounting details regarding sheetrock and concrete walls).
- To ensure wall mount is not being installed upside down, verify that edges slope inwards and become narrower at the bottom; curved metal arch found at bottom of wall mount should face outwards.
- Hold wall mount securely and begin inserting screws into appropriate pre-drilled holes; be sure to use appropriate anchors or washers with proper screws.

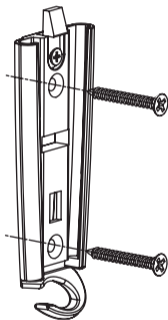

Wall-Type Mounting Details

Mounting To Wood Studs Under Sheetrock Wall:

Pre-drill holes according to markings on wall with a 3mm drill bit; be sure pre-drilled holes are at least 30mm deep; use appropriate wall anchors to attach wall mount (please verify that included anchors are appropriate).

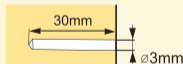

Mounting To Solid Concrete Wall:

Pre-drill holes according to markings on wall with a 12.7mm drill bit; be sure pre-drilled holes are at least 60mm deep; use appropriate wall anchors to attach wall mount (please verify that included anchors are appropriate).

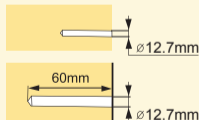

STEP 4:
**Hanging Flatscreen
Device On Wall Mount**

- With mounting bracket arm securely fastened to rear of flatscreen device, lift entire flatscreen display over wall mount and - with the flatscreen positioned above - slide mounting bracket into track found on wall mount and push downward until safety latch clicks into place.

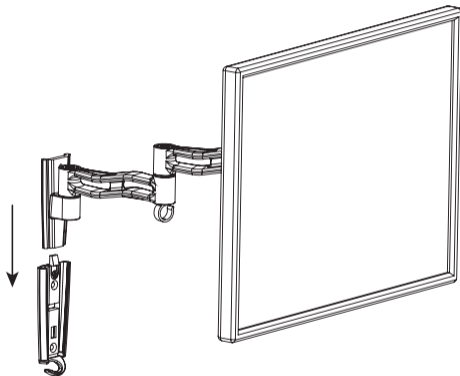

STEP 5: Positioning Installed Wall Mount

- Upon installation completion, secure power cord for flatscreen device by running it through the loop found on bottom of middle arm joint; then slip it through metal arch found on bottom of wall bracket and attach plug to power source. Wall mount can be positioned in of the following 3 configurations:

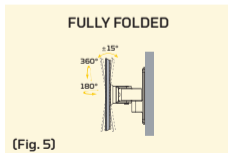
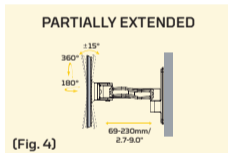
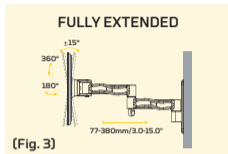

- NOTE: As a security and safety feature, included hex key can be used to lock flatscreen device to wall mount by inserting hex key into screw found atop bracket joint and twisting clockwise; flatscreen device can be removed by twisting hex key counterclockwise

Safety Warnings

- 1 Do not use this product for any flat panel screen device other than what it is intended for; the exact specifications, size parameters and weight limits are found both on the product box and in the instruction manual
- 2 It is strongly recommended that this product be installed by a qualified professional or installation contractor; Gabor takes no responsibility for any product damage or personal injury resulting from mishandling, incorrect mounting, faulty assembly or improper use of this product
- 3 This product has been designed specifically for mounting directly on wooden studs or concrete walls; depending on wall type and material, the use of additional appropriate mounting hardware and/or accessories such as heavy-duty anchors may be required
- 4 The supplied mounting hardware is not intended for use on metal studs or cinderblock walls, and may not be appropriate for old or weak walls; it is best to consult with a qualified professional to determine whether your walls are capable of supporting this bracket
- 5 Product must always be mounted directly to center of wooden wall studs or on a solid concrete wall to properly support the weight of the device; the wall may require reinforcement prior to mounting (i.e. metal studs; plaster on lath; or irregular spacing of studs), which should be determined by a qualified professional
- 6 Do not mount device on structures that may be affected by vibrations or noticeable impacts; do not install near heater, fireplace or any other source of direct heat energy
- 7 It is recommended that at least 2 people should perform the installation process to prevent injury from mishandling or dropping of the product and/or flatscreen device; proper safety gear and tools must be utilized at all times when installing product
- 8 When installing this product, be sure to refer to mounting instructions detailed in this manual; failure to abide by mounting instructions may void product warranty
- 9 This product may contain small parts which can possibly pose a choking hazard; keep out of reach of children and pets
- 10 Excessive exposure to liquids may damage the finish of this product; when cleaning this product, use only a mild detergent solution and quickly wipe dry with a soft cloth

Customer Support

For more information or to arrange service, visit www.madebygabor.com or call Customer Service at 212-594-2353.



Product warranty is provided by the Gradus Group.
www.gradusgroup.com

Gabor is a registered trademark of the Gradus Group.

© 2014 Gradus Group LLC.
All Rights Reserved.

GG2

ONE-YEAR LIMITED WARRANTY:

This GABOR product is warranted to the original purchaser to be free from defects in materials and workmanship under normal consumer use for a period of one (1) year from the original purchase date or thirty (30) days after replacement, whichever occurs later. The warranty provider's responsibility with respect to this limited warranty shall be limited solely to repair or replacement, at the provider's discretion, of any product that fails during normal use of this product in its intended manner and in its intended environment. Inoperability of the product or part(s) shall be determined by the warranty provider. If the product has been discontinued, the warranty provider reserves the right to replace it with a model of equivalent quality and function.

This warranty does not cover damage or defect caused by misuse, neglect, accident, alteration, abuse, improper installation or maintenance. EXCEPT AS PROVIDED HEREIN, THE WARRANTY PROVIDER MAKES NEITHER ANY EXPRESS WARRANTIES NOR ANY IMPLIED WARRANTIES, INCLUDING BUT NOT LIMITED TO ANY IMPLIED WARRANTY OF MERCHANTABILITY OR FITNESS FOR A PARTICULAR PURPOSE. This warranty provides you with specific legal rights, and you may also have additional rights that vary from state to state.

To obtain warranty coverage, contact the Gabor Customer Service Department to obtain a return merchandise authorization ("RMA") number, and return the defective product to Gabor along with the RMA number and proof of purchase. Shipment of the defective product is at the purchaser's own risk and expense.

The image features a dark, rich brown wood grain texture. The grain lines are wavy and run horizontally across the frame. In the center, there is a faint, circular watermark that appears to be a stylized logo or emblem, though its details are not clearly defined. At the bottom center, the website address 'WWW.MADEBYGABOR.COM' is printed in a bright yellow, sans-serif font.

WWW.MADEBYGABOR.COM