

1/2-Axes Motor Control Unit

MR210AU / MR220AU

User's Manual

2004-02-18	Ver. 1.0
2007-04-04	Ver. 1.1
2008-12-12	Ver. 3.3
2010-06-30	Ver. 3.4

NOVA electronics

Introduction

Thank you for purchasing MR210AU/MR220AU motion control unit.

■ Checking the contents

When you unpack the package, check for the following accessories. If something is missing or broken, contact the place of purchase.

Model	MR210AU	MR220AU		
Accessories	MR210AU	1	MR220AU	1
	RS232C Cable	1	RS232C Cable	1
	USB Cable	1	USB Cable	1
	24V Power Connector (CN1)	1	24V Power Connector (CN1)	1
	20P MIL Connector (CN3)	1	20P MIL Connector (CN3)	1
	16P MIL Connector (CN4)	1	16P MIL Connector (CN4,5)	2
	User's Manual (with CD-ROM)	1	User's Manual (with CD-ROM)	1



Warning

: This mark indicates the user that improper use may cause death or injury of the user or people in the vicinity or material damages.



Caution

: This mark indicates the user that improper use may cause damage to the equipment or the loss of valuable data.

■ General Safety Instructions



Warning

Do not use the equipment in locations subject to oil fumes. Do not disassemble, repair or modify the equipment. Otherwise, fire or electric shock may result and cause death or serious injury.



Caution

Prior to use, read this operation manual carefully to fully understand for correct use and follow all the instructions given in this manual. We shall be exempted from taking responsibility and held harmless for damage or losses incurred by the user if the user fails to observe the instructions.



Caution

Use the following environmental conditions.

Ambient Temperature	0~45°C
Humidity	20~90% (no condensation)
Floating dust	Not to be excessive
Corrosive gases	None
Electric supply source	DC24V ±10%



■ Handling Precautions

- When connecting the power cable or connection cable, turn off the equipment power. Otherwise, breakdown or operation error may result.
- Do not disassemble, repair or modify the equipment.
- When using the provided software, connect a cable first and then turn on power and start the software.
- When using serial communication instead of the provided software, refer to serial communication commands book.
- RS232C and USB cables are prepared as communication cables. MR210AU/MR220AU can connect with the USB cable; however, it can select only one cable either RS232C or USB. Otherwise, it does not work correctly. When connecting the cable, turn off the equipment power.

Information in this manual is subject to change without notice.

Microsoft and Windows are registered trademarks of Microsoft Corporation.

1.Outline	1
2.Setup Operating Program.....	4
2.1 Operating Program Installation.....	4
2.1.1 Operating Program Installation.....	4
2.1.2 Uninstallation.....	7
2.2 Setup with USB cable.....	8
2.2.1 USB device driver installation.....	8
2.2.2 Check Operating Program Start-up.....	8
2.3 Setup with RS232C cable.....	9
3.Driving Mode and Parameters Configuration	10
3.1 Mode Setting.....	10
3.2 Parameter Setting.....	14
3.3 Home Search Mode Setting.....	18
3.3.1 The Description of Home Search Operation.....	18
3.3.2 Home Search Mode Setting.....	19
3.3.3 Example for Home Search Mode Setting.....	22
4.Driving Program	25
4.1 Driving program commands.....	25
4.2 Input/Output Ports.....	30
5.Driving by parallel I/F	31
5.1 Home Search Execution.....	31
5.2 Index Driving.....	31
5.3 Scan Driving.....	32
5.4 Continuous Driving.....	33
5.5 Program Driving.....	33
6.Operation by PC	34
6.1 Start Operating Program.....	34
6.2 Main Screen.....	35
6.3 Parameter / Mode Screen.....	39
6.3.1 Mode Tab.....	39
6.3.2 Parameter Tab.....	40
6.3.3 Home Search Mode Tab.....	41
6.4 Program Edit Screen.....	42
6.5 Input/Output Screen.....	44

6.6	Error List.....	45
7.	Remote Box Operations	46
7.1	Data Edit Operation	48
7.1.1	Register Select	48
7.1.2	Register Configuration	48
7.1.3	Writing of Driving Programs	49
7.1.4	Writing of Driving Mode and Parameters.....	51
7.1.5	One Command Execution	52
7.2	Drive Operation	52
7.2.1	Home Search.....	52
7.2.2	Jog Feed	53
7.2.3	Program Execution.....	53
7.2.4	Current Position Writing.....	54
8.	Input/Output Signal Connection.....	55
8.1	CN1 Power Connector.....	55
8.2	CN2 RS232C Serial I/F Connector	55
8.3	CN3 Parallel I/F Connector	56
8.4	CN4, 5 Axis I/O Connector.....	59
9.	Package Dimensions.....	61
10.	Specifications	62

1. Outline

MR210AU/220AU is a motion control unit which can control one or two axes of either stepper motor or pulse type servo drives for position and speed controls. A built-in EEPROM can program driving parameter values and position data of up to 64 steps for each axis. MR210AU controls 1-axis and MR220AU controls 2-axes.

Model	Axes	Serial Communication Port
MR210AU	1	equipped with RS-232C, USB.
MR220AU	2	equipped with RS-232C, USB.

Fig.1.1 shows the MR210AU/220AU basic circuit block diagram.

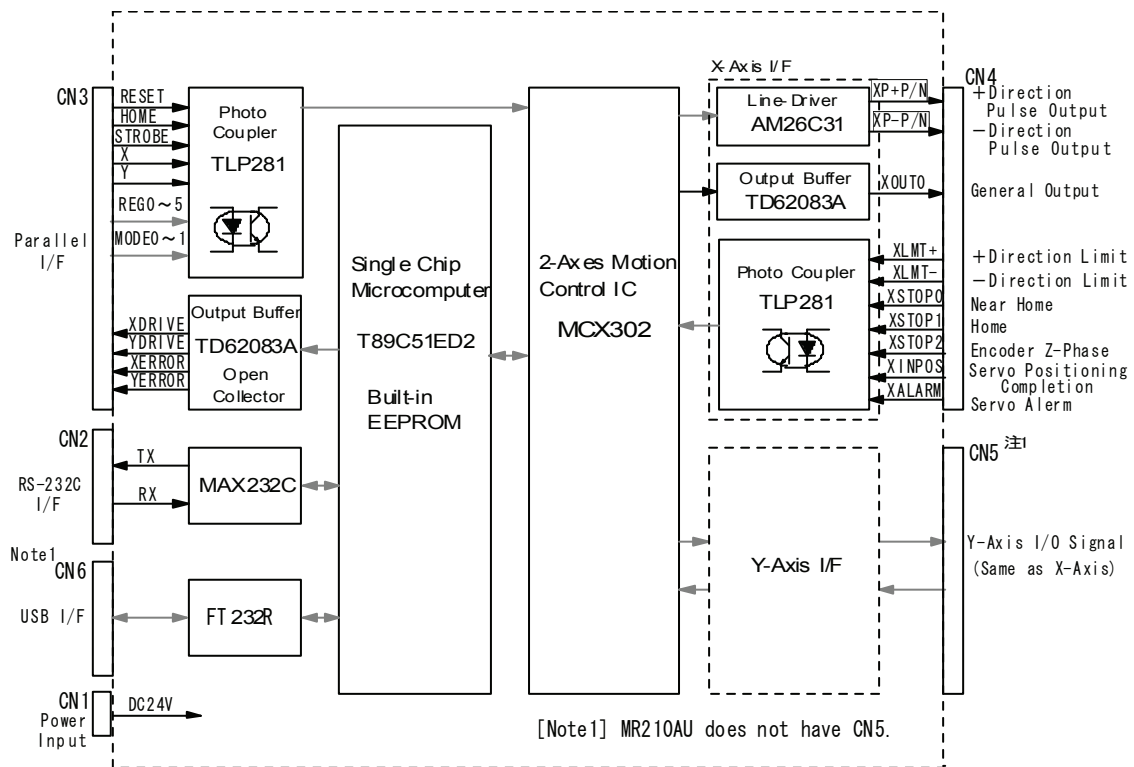

Fig.1.1 MR210AU/220AU Circuit Block Diagram

A 2-axes motion control IC “MCX302” is equipped with acceleration/deceleration drive pulse oscillation of up to 4MHz and a position counter.

Driving pulse output to a motor driver is differential line-drive output, which can connect to the motor driver of either photo coupler input or differential line receiver input.

Sensor input is insulated by photo coupler, which can input over run limits, a home, an in-position and alarm signal from a servo motor driver.

Serial communication port has two interfaces, RS232C and USB. Connect the serial communication port and PC or a remote box (option), then set data such as driving parameter mode, position data and program data. In addition, serial communication commands are prepared so that the user can freely control the axis by programming on Windows.

Parallel interface port performs actual drive activation, stop, position and program selection, which connects to a PLC or switches.

■ Appearance

Fig.1.2 shows the appearance of the MR220AU, its package dimensions are 90mm (H)×36mm (W)×60mm (D). Input/output connectors are placed on front panel and rear panel is equipped with DIN rail installing hook.

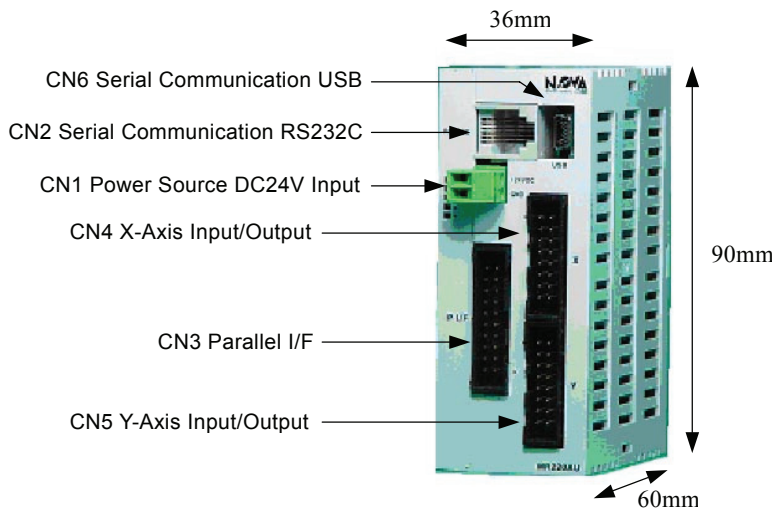

Fig.1.2 MR220AU Appearance

■ Operational Procedures

MR210AU/220AU operations are performed by following procedures (1)~(4).

(1) Operating Program Installation

Operating program is the tool to write driving parameter mode or driving programs from PC to MR210AU/220AU, which the user can install from the accessory CD-ROM. See chapter 2.

(2) Setting of Driving Parameter Mode and Program

Connect PC and MR210AU/220AU with the cable that comes with the package, then set driving parameter mode and programs by the operating program installed in step (1). These setting data will be written in a built-in EEPROM.

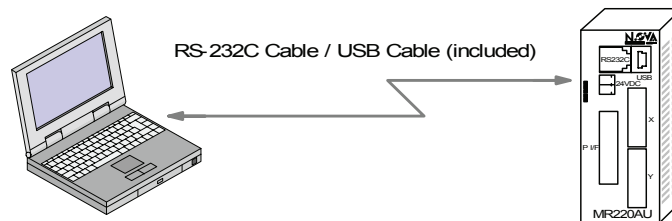

In addition, driving parameter mode and programs can be set through the optional remote box (MR200RB), which connects to the RS232C port of the motor control unit.

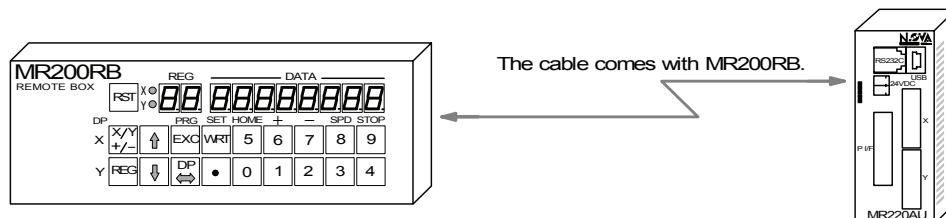

(3) Connection of Motor Driver and Sensor

Connect a motor driver to a driving pulse signal and input from a sensor to over limit signals or a home signal of each axis. In-position and alarm input signals are prepared for the servo motor.

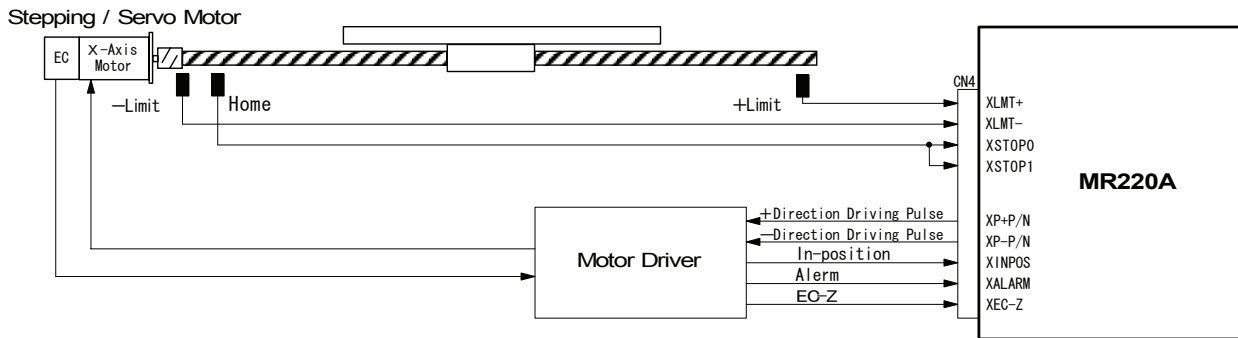

Fig.1.3 Connection Example of Axis I/O Signals

See chapter 8 for more details on input/output signals and connection examples of a motor driver or a sensor.

(4) Drive Activation

There are four methods to activate MR210AU/220AU as follows (a. ~ d.).

a. Activation from Parallel I/F

The method to activate by connecting a PLC or switches to parallel I/F connector. See chapter 5.

b. Activation from PC

Connect PC with the communication cable and start the operating program, the user can perform manual operations such as jog feed of each axis, home search and program execution from main operational panel. See chapter 6.

c. Activation from Remote Box

Connect with the cable that comes with a remote box, the user can perform jog feed, home search and program execution by drive operation of the remote box. See chapter 7.

d. Control by Serial Communications

MR210AU/220AU has serial communication commands (separate book). Connect MR210AU/220AU and your PC or a PLC with the USB or RS232C cable, the user can control axes on your own program.

2. Setup Operating Program

The operating program is the tool to write driving parameter mode or driving programs from PC to MR210AU/220AU. The accessory CD-ROM contains the operating program, which is composed of three directories as follows:

- InstMS Folder ----- Installer for OS before Windows XP.
- MRPRG Folder ----- MR210AU/220AU Operating program
- Driver Folder ----- USB device driver

The latest version is available on our web site: <http://www.novaelec.co.jp/eng/index.html> .

First install the operating program from MR200 Series CD-ROM according to chapter 2.1. Then, to make connection with the motor control unit, if using USB communication, follow steps in chapter 2.2. If using RS232C communication, follow steps in chapter 2.3.

2.1 Operating Program Installation

2.1.1 Operating Program Installation

(1) Insert MR200 Series CD-ROM into the CD drive.

[Note] Do not connect MR210AU/220AU and your PC at this time. Although the user can install while being connected, if using the USB cable, operating system will ask for the driver in the first connection. In this case, the user should install the USB device driver in advance according to chapter 2.2.1.

(2) Windows 2000 users: double-click the installer to build on your hard disc.

Windows 2000 users ----- Execute **InstMsiW.exe** in InstMS folder.

Windows XP users don't need to do anything for this step.

(3) Double-click **MR220A.msi** program file in MRPRG folder. In a while, setup screen will be invoked and then installation will start. Follow the on-screen instructions below.

(4) When the Setup Wizard appears, click **Next**.

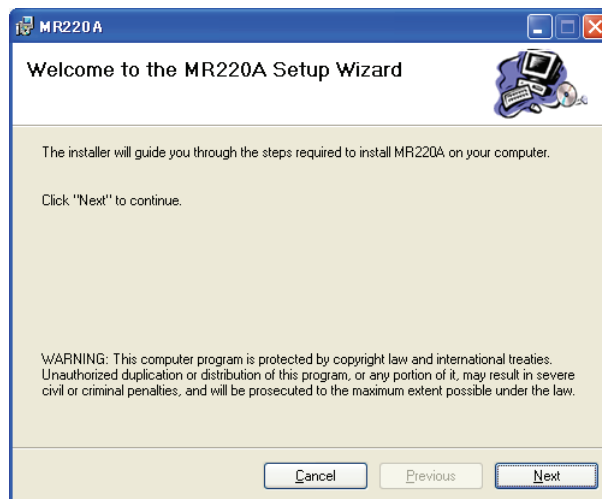

(5) On the Select Installation Folder screen, click **Next**, which uses the default settings.

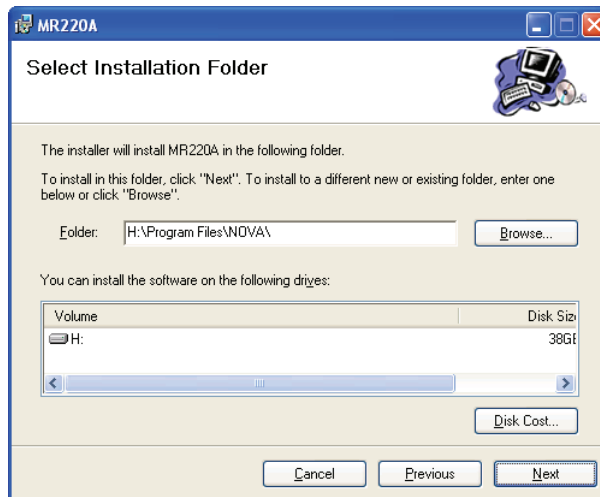

(6) On the Confirm Installation screen, click **Next**.

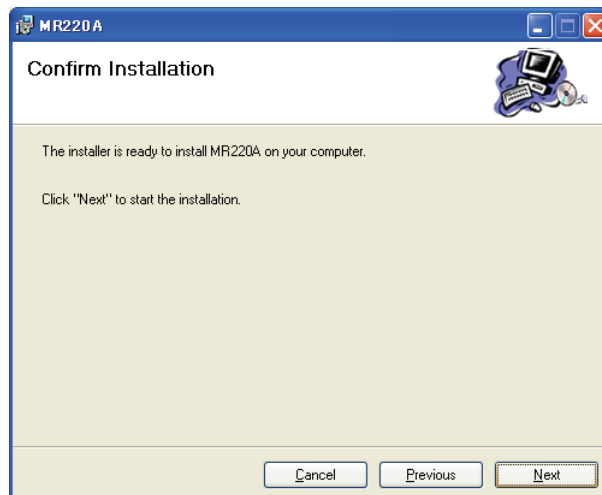

(7) On the user's account control, click "Yes".
* Only on Windows 7.

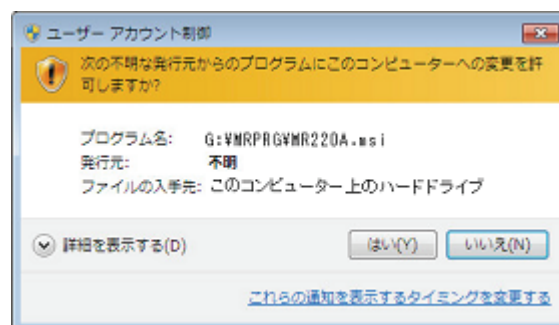

(8) MR220A is now installed.

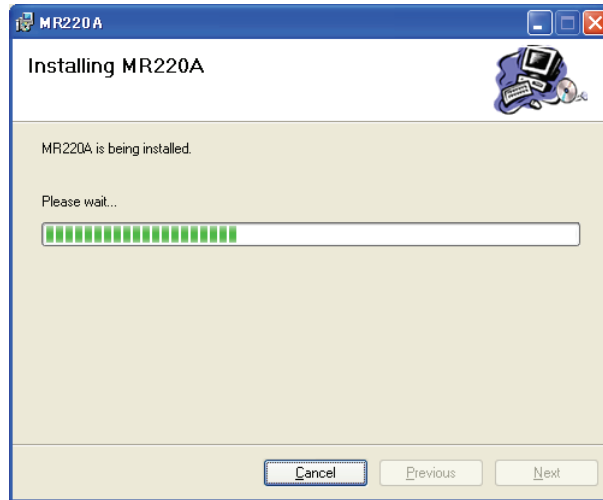

(9) When the installation is complete, the Installation Complete screen appears. Click **Close** to complete setup.

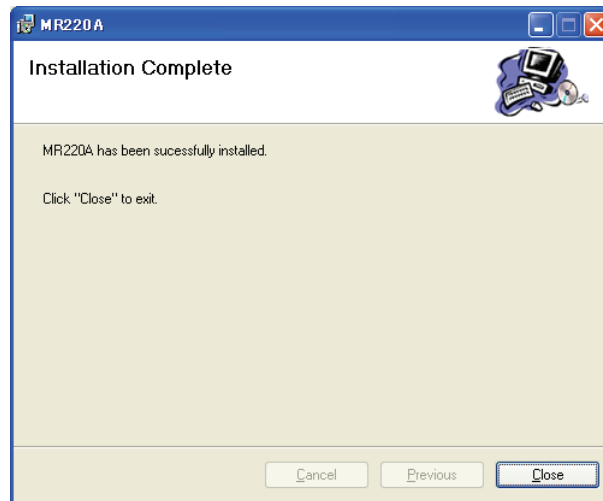

2.1.2 Uninstallation

Usually this removal process is not needed. Please follow these steps when updating the operating program to the latest version or removing from your hard disc.

(1) To uninstall the program, use “Add/Remove Programs” utility in the Windows Control Panel. Or on windows 7, use “Program”, “Program and function” and “Uninstallation or change of program”.

(2) Select the “MR220A” program from the list, then click **Add/Remove** button. The operating program will be uninstalled.

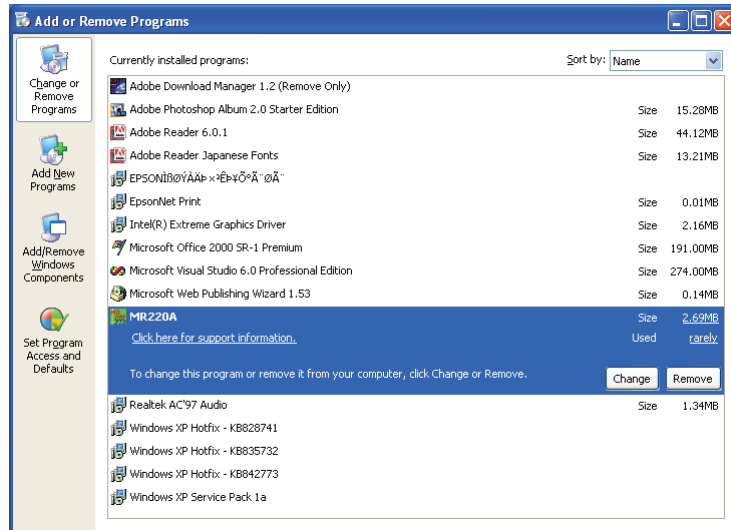

(3) On the user's account control, click "Yes".

* Only on Windows 7.

(4) Select “MR220A” program from the list, then click **Remove** button. The operating program will be uninstalled

*On Windows 7, unistallation of “MR220A” is operated automatically.

2.2 Setup with USB cable

2.2.1 USB device driver installation

Connect the motor control unit and PC with the USB cable, then turn on both equipment power. If this is first connection with the USB cable, new hardware will be detected. Insert MR200 Series CD-ROM into the CD drive and install USB device driver. Please specify the folders “\driver” which is downloaded in the CD-ROM.

After installation, verify it using Windows Device Manager as follows:

Click Control Panel → System → Hardware tab → Device Manager, if USB device driver (“USB to Serial port”) is found under Ports (COM & LPT) (Please note listed below.), the installation is successfully completed.

[Note1] Installation Wizard appears twice.

[Note2] USB driver installation is needed once every unit. For example, if 3 units are connected to PC, USB driver should be installed three times.

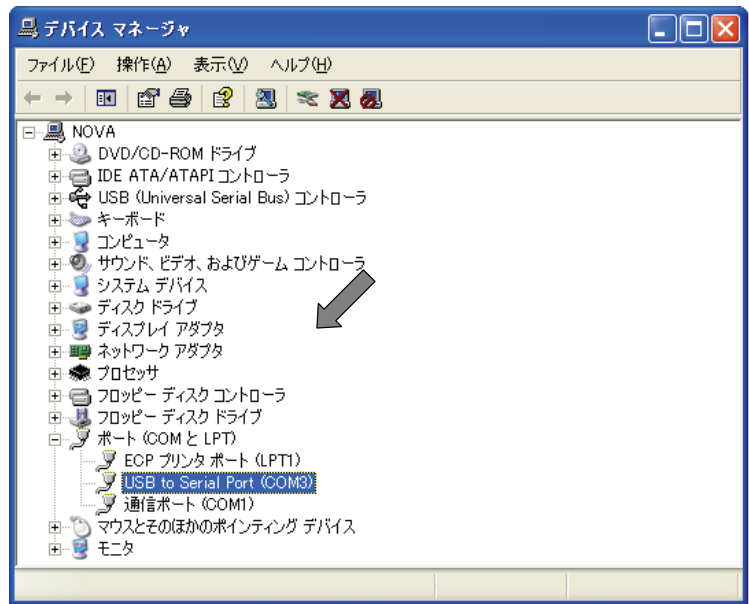

2.2.2 Check Operating Program Start-up

According to chapter 6.1, check the operating program properly starts when connecting to the motor control unit.

When the operating program is first started after installation, it may be offline mode even though the cable is connected. In this case, click **Option** menu on the upper left of the main window, then check (V) **COM** option connected with the motor control unit, then exit the operating program and restart it.

[Note] The COM number using with USB connecting, click Control Panel → System → Hardware tab → Device Manager, the user can find it after USB device driver name (“USB to Serial Port”) under Ports (COM & LPT).

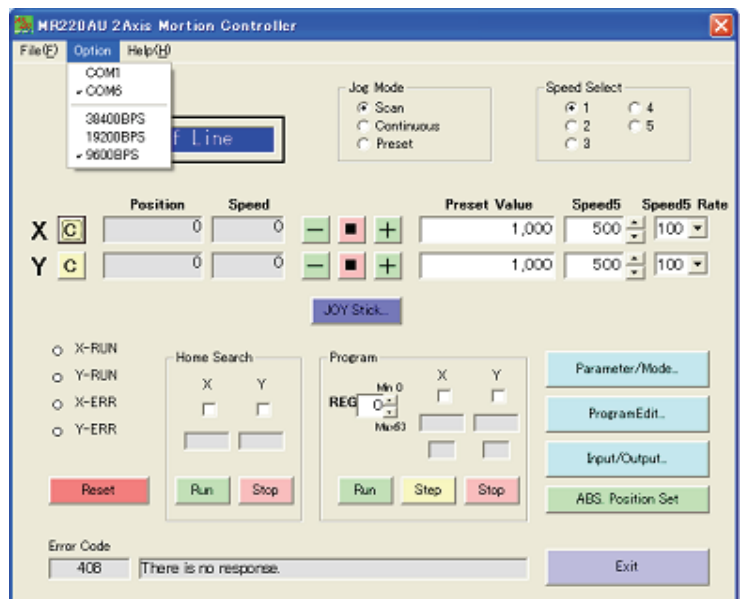

2.3 Setup with RS232C cable

(1) Connect the motor control unit and PC with the RS232C cable.

(2) Turn on both equipment power.

(3) Start the operating program from Start menu.

On the Start menu, point to Programs, then click Motion Controller → MR220A → MR220A.

(4) In the first connection, the following error message appears.

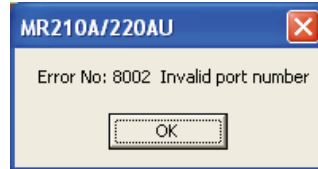

After clicking **OK**, communication open error message appears.



Click **OK**.

(5) Select Style dialog box appears, click the type MR220AU or MR210AU which the user uses.

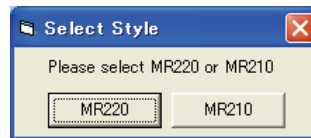

(6) The operating program is invoked in offline mode.

Click Option menu, then check (V) the COM port connected with the RS232C cable.

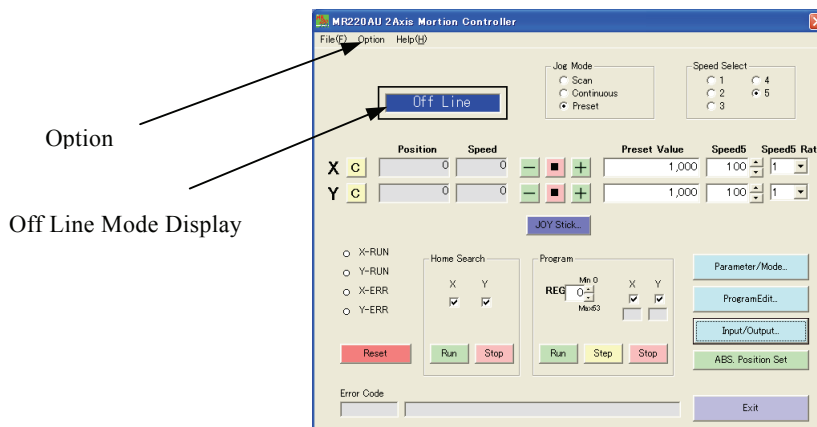

(7) Exit the operating program once and restart it. Make sure that the operating program is invoked in online mode.

3. Driving Mode and Parameters Configuration

To operate MR210AU/220AU, it is first necessary to configure driving mode and parameters for MR210AU/220AU based on the user system. Connect MR210AU/MR220AU and PC with the RS232C or USB cable and start the operating program on Windows, the user can configure driving mode and parameters in Mode / Parameter screen.

In addition, driving mode and parameters can be configured using an optional remote box (MR200RB), which connects to the RS232C port of the motor control unit. See chapter 7 for details on how to configure by the remote box.

Start Operating Program

Connect MR210AU/220AU and PC with the cable and then start the operating program. (See chapter 6.1 for details on how to start the operating program.) When the main screen appears, click **Parameter / Mode** button. Parameter / Mode screen appears.

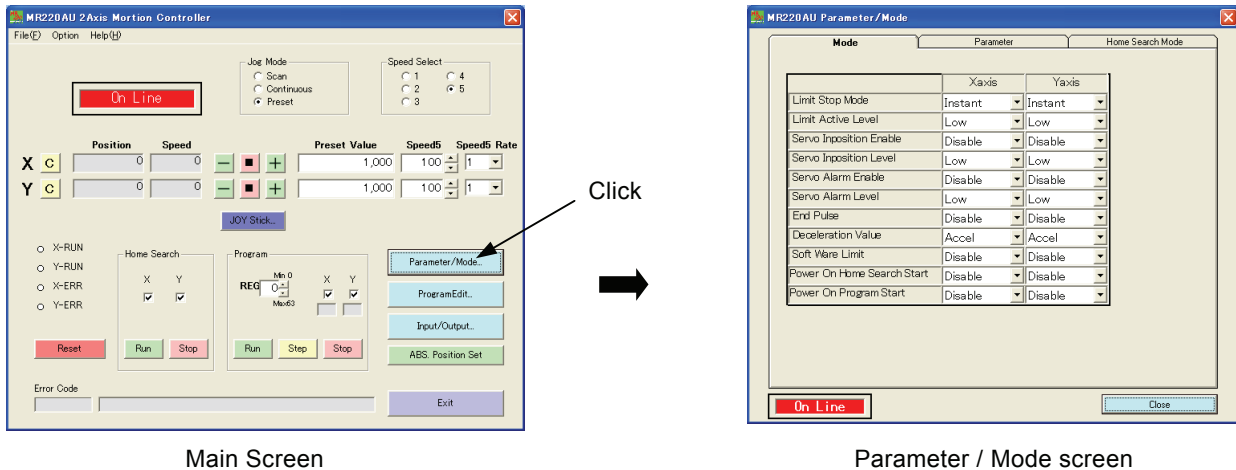

Main Screen

Parameter / Mode screen

Parameter / Mode screen has three tabs: Mode, Parameter and Home Search Mode. Hereinafter describe how to configure in each tab based on the user system.

3.1 Mode Setting

Click **Mode** tab to change Mode screen if not displayed. MR210AU has X-axis only.

	Xaxis	Yaxis
Limit Stop Mode and Logical Level	Limit Stop Mode Instant	Instant
Servo Inposition Enable and Logical Level	Limit Active Level Low	Low
Servo Alarm Enable and Logical Level	Servo Inposition Enable Disable	Disable
Driving End Pulse	Servo Inposition Level Low	Low
Deceleration Value Selecting	Servo Alarm Enable Disable	Disable
Software Limit	Servo Alarm Level Low	Low
Power On Home Search Start	End Pulse Disable	Disable
Power On Program Start	Deceleration Value Accel	Accel
	Soft Ware Limit Disable	Disable
	Power On Home Search Start Disable	Disable
	Power On Program Start Disable	Disable

Limit Stop Mode and Logical Level

Selects either instant stop or deceleration stop for driving when a limit signal becomes active, and specify a logical level either hi or low.

Display	Option	Default
Limit Stop Mode	Instant (Instant stop) / Slow (Deceleration stop)	Instant
Limit Active Level	Low (GEX Short-circuited) / High (Open)	Low

Over limit input signals (nLMT+/-) for +/- direction of each axis are the #12, #13 pins in CN4, 5 connectors (See chapter 8.). Limit Stop Mode selects either Instant Stop or Deceleration Stop for when this over limit input signal becomes active. Besides, Limit Active Level specifies the logical level for active. To make active for when the over limit input signal and GEX are short-circuited, set low to the logical level and to make active for when it is open, set high to the logical level.

■ Servo Inposition Enable and Logical Level

Selects action for an inposition input signal from a servo motor driver.

Display	Option	Default
Servo Inposition Enable	Disable / Enable	Disable
Servo Inposition Level	Low (GEX Short-circuited) / High (Open)	Low

Inposition input signals (nINPOS) of each axis are the #6 pins in CN4, 5 connectors (See chapter 8.).

When Servo Inposition Enable selects Enable, after output of driving pulses, driving will terminate after checking the inposition input signal (nINPOS) becomes active. While the program is running, after execution of drive commands (ABS, INC), next register will be performed after checking the inposition input signal becomes active.

Logical level (Servo Inposition Level) selects for active either when the inposition input signal (nINPOS) is open or when the inposition input signal is short-circuited with GEX. When selecting open for active, set high and when selecting GEX Short-circuited for active, set low.

If the inposition input signal (nINPOS) is not used like in the case of a stepping motor, set default values.

■ Servo Alarm Enable and Logical Level

Selects action for an alarm input signal from a servo motor driver.

Display	Option	Default
Servo Alarm Enable	Disable / Enable	Disable
Servo Alarm Level	Low (GEX Short-circuited) / High (Open)	Low

Servo alarm input signals (nALARM) of each axis are the #7 pins in CN4, 5 connectors (See chapter 8.).

When Servo Alarm Enable is enabled and when the servo alarm input signal (nALARM) becomes active during driving, pulse output of its axis immediately stops and then turn on the nERROR output signal.

Logical level (Servo Alarm Level) selects for active either when the servo alarm input signal is open or when the servo alarm input signal is short-circuited with GEX. When selecting open for active, set high and when selecting GEX Short-circuited for active, set low. To clear an error after the error occurs, make the servo alarm input signal inactive and then reset the motor control unit.

If the servo alarm input signal (nALARM) is not used, set default values.

■ Driving End Pulse

Outputs End Pulse from the nDRIVE/END signal of the parallel I/F connector at the end of driving.

Display	Option	Default
End Pulse	Disable / Enable	Disable

DRIVE/END output signals of X and Y axes are #14, 15 pins in CN3 of the parallel I/F connector (See chapter 8.).

When driving end pulse (END Pulse) is disabled, the nDRIVE/END signal will be ON during drive of each axis or execution of the program, and will be OFF at the end of driving.

When enabled, the nDRIVE/END signal will be OFF during index driving of ABS, INC, which are specified as End Pulse Enable in commands, or home search driving. And ON pulses will be output for the period of the End Pulse Width, which is specified by the parameter, at the end of driving. While executing the program, ON pulses are also output after execution of ABS, INC, HOM commands which are specified as End Pulse Enable in commands.

■ Deceleration Value Selecting

Selects either acceleration value (symmetry acceleration/deceleration) or deceleration value individually (non-symmetry acceleration/deceleration) as a deceleration speed at deceleration in trapezoidal driving.

Display	Option	Default
Deceleration Value	Accel (Acceleration) / Decel (Deceleration)	Accel

MR210AU/220AU can perform not only symmetry acceleration/deceleration driving where the acceleration and the deceleration are same but also non-symmetry acceleration/deceleration driving where the acceleration and the deceleration are different. When selecting Accel (Acceleration), the acceleration parameter is used as a deceleration speed at deceleration and driving becomes symmetry trapezoidal. When selecting Decel (Deceleration), the deceleration parameter is used as a deceleration speed and driving becomes non-symmetry trapezoidal.

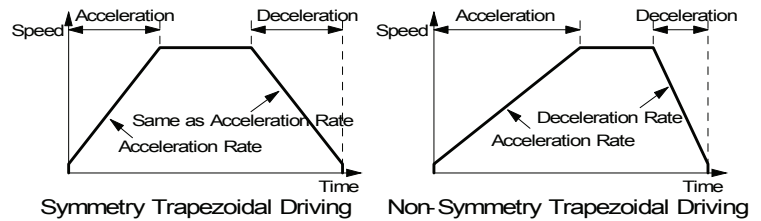

[Note] Please note that the following (1), (2) for when non-symmetry trapezoidal acceleration/deceleration driving is performed.

(1) In the case of acceleration > deceleration, the following condition is applied to the ratio of the acceleration and the deceleration.

$$D > A \times \frac{V}{4 \times 10^6}$$

D : Deceleration rate (pps/sec)
 A : Acceleration rate (pps/sec)
 V : Drive speed (pps)

For instance, if driving speed V = 100kps, deceleration D must be greater than 1/40 of acceleration A. The value must not be less than 1/40 of the acceleration.

(2) If acceleration > deceleration, the greater the ratio of acceleration A to deceleration D becomes, the greater the number of creep pulses (outputs of specified driving pulses are not completed at deceleration of index driving even if the speed reaches the initial-speed and remaining driving pulses are output at initial-speed.) becomes. Approximately maximum of 10 pulses when A/D=10 times.

■ Software Limit

Selects either Disable or Enable for software limit.

Display	Option	Default
Soft Ware Limit	Disable / Enable	Disable

Software Limit is the over run limit function which can internally set as position data; it differs from hardware limit signal input such as an external sensor. Software limit can be set as parameters for + and – direction respectively. When selecting enable, and when the position counter is over the software limit + to – range during driving, decelerating stop will be performed. This error condition will be cleared if the user drives in the opposite direction and sets the position counter back within a software limit range.

[For reference] While a home search is running, the software limit does not function even if enabled.

■ Power On Home Search Start

Selects either Disable or Enable for automatic home search at power-on.

Display	Option	Default
Power On Home Search Start	Disable / Enable	Disable

Power On Home Search Start is the function to automatically perform home search when the power is on or motor control unit is reset.

■ Power On Program Start

Selects either Disable or Enable for automatic program start at power-on.

Display	Option	Default
Power On Program Start	Disable / Enable	Disable

Power On Program Start is the function to perform automatically the registered program from REG00 when the power is on or motor control unit is reset. If Power On Home Search Start is also enabled, the program will be performed after completion of home search operation.

[Note]

- (1) When using Power On Program Start, write timer command to REG00 in advance, then make sure that next command is operated after passing the specified period. In addition, it recommends to embed home search command into the program.
- (2) Do not release Power On Program Start or Power On Home Search Start during driving. Make sure to first stop driving in main screen (click STOP button) and then disable them in parameter/mode screen in advance.
- (3) Do not alter the program or mode/parameters while executing the program by Power On Program Start. Make sure to first stop in main screen (click STOP button) in advance.

3.2 Parameter Setting

Click **Parameter** tab to change Parameter screen if not displayed. MR210AU has X-axis only.

	Xaxis	Yaxis
Speed Multiplier	10	10
Acceleration Rate	400	400
Deceleration Rate	400	400
Start Speed	50	50
Drive Speed 1~4	10	10
	100	100
	1,000	1,000
	8,000	8,000
Post Timer 1~3	10	10
	100	100
	1,000	1,000
Home Search Low Speed	20	20
Home Search High Speed	1,000	1,000
Home Search Offset	100	100
Software Limit +	8,388,607	8,388,607
Software Limit -	-8,388,608	-8,388,608
Driving End Pulse Width	100	100
Pulse Scale Numeration	1,000	1,000
Pulse Scale Denomination	1,000	1,000

■ Speed Multiplier

Speed Multiplier is the parameter which decides the multiplication of the speed parameter such as drive speed or acceleration/deceleration speed.

Display	Setting Range	Default
Speed multiplier	1 ~ 500	10

Speed parameters such as drive speed, start speed and acceleration/deceleration speed can be set within the range from 1 to 8,000. If the user sets the larger value than that, the speed multiplier must be raised. When raising the speed multiplier, the user can drive at high-speed but speed resolution becomes rough. Set the minimum value which covers the range of drive speed.

■ Acceleration Rate

Acceleration Rate is the parameter used as acceleration rate at acceleration in acceleration driving. When setting Deceleration Value to Accel (default value) in mode setting, this acceleration rate will also be used at deceleration.

Display	Setting Range	Default
Acceleration Rate	1 ~ 8000	400

If the value for acceleration rate is A, actual acceleration rate is as follows:

$$\text{Acceleration Rate (pps/sec)} = A \times 125 \times \text{Speed Multiplier}$$

To perform acceleration driving, as shown in the diagram, four parameters: initial speed, drive speed, acceleration rate and deceleration rate must be set. However, if performing symmetry trapezoidal driving, no need to set deceleration rate.

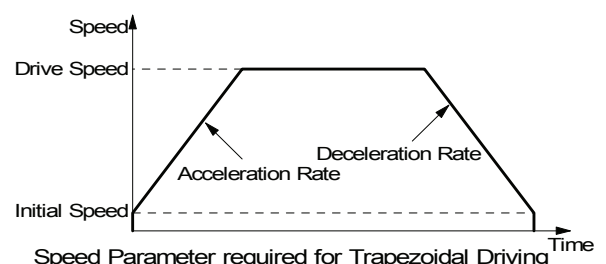

For instance, if the initial speed 500pps is raised up to 20,000pps in 0.3 seconds, speed parameter should be set as follows:

$$\text{Acceleration Rate (pps/sec)} = (20,000 - 500) / 0.3 = 65,000 \text{ (pps/sec)}$$

If speed multiplier is 10,

$$\text{Setting value for acceleration rate } A = 65,000 / (125 \times 10) = 52$$

$$\text{Setting value for start speed } SV = 500 / 10 = 50$$

$$\text{Setting value for drive speed } V = 20,000 / 10 = 2,000$$

■ Deceleration Rate

Deceleration Rate is the parameter used as deceleration rate at deceleration in acceleration driving.

Display	Setting Range	Default
Deceleration Rate	1 ~ 8000	400

If the value for deceleration rate is D, actual deceleration rate will be as follows:

$$\text{Deceleration Rate (pps/sec)} = D \times 125 \times \text{Speed Multiplier}$$

In default mode setting, Deceleration Value is set to Accel, therefore, acceleration rate is also used at deceleration and driving becomes symmetry trapezoidal. If the user wants to perform non-symmetry trapezoidal driving, change Deceleration Value to Decel in mode setting and set this deceleration rate.

■ Start Speed

This is the speed at the start of acceleration/deceleration driving and at the end of driving.

Display	Setting Range	Default
Start Speed	1 ~ 8000	50

Actual start speed is the value which multiplies the start speed value by speed multiplier.

$$\text{Start Speed (pps)} = SV \times \text{Speed Multiplier}$$

When drive speed is larger than this start speed, acceleration/deceleration driving is performed. In this case, the parameter of acceleration/deceleration rate must be set. When drive speed is smaller than the start speed, constant speed driving starts instead of acceleration/deceleration. Home search at high-speed is as well.

■ Drive Speed 1~4

Drive speed is the speed of constant speed period in acceleration/deceleration driving.

Display	Setting Range	Default
Drive Speed 1	1 ~ 8000	10
Drive Speed 2	1 ~ 8000	100
Drive Speed 3	1 ~ 8000	1000
Drive Speed 4	1 ~ 8000	8000

Each axis can set four types of drive speed. The user selects one drive speed from four types for driving.

Actual drive speed is the value which multiplies the drive speed value by speed multiplier.

$$\text{Drive Speed (pps)} = V \times \text{Speed Multiplier}$$

When drive speed is larger than the start speed, acceleration/deceleration driving is performed. In this case, the parameter of acceleration/deceleration rate must be set. When drive speed is smaller than the start speed, constant speed driving starts instead of acceleration/deceleration.

■ Post Timer 1~3

Post timer is the waiting time until next command starts after execution of drive commands such as ABS, INC for program operation. Three types of post timer can be registered.

Display	Setting Range	Default
Post Timer 1	1 ~ 65535 (Unit: msec)	10
Post Timer 2	1 ~ 65535	100
Post Timer 3	1 ~ 65535	1000

■ Home Search Low Speed

Sets search speed for step 2, step 3 of home search.

Display	Setting Range	Default
Home Search Low Speed	1 ~ 8000	20

Actual speed is the value which multiplies the setting value by speed multiplier.

$$\text{Home Search Low Speed (pps)} = \text{Setting Value} \times \text{Speed Multiplier}$$

[Note] Home search low speed must set smaller value than start speed.

■ Home Search High Speed

Sets search speed for step 1, step 4 of home search.

Display	Setting Range	Default
Home Search High Speed	1 ~ 8000	1000

Actual speed is the value which multiplies the setting value by speed multiplier.

$$\text{Home Search High Speed (pps)} = \text{Setting Value} \times \text{Speed Multiplier}$$

Home search high speed usually sets larger value than start speed to perform acceleration/deceleration driving.

■ Home Search Offset

Sets offset drive for home search. If 0 is set, offset drive is not performed.

Display	Setting Range	Default
Home Search Offset	-8388608 ~ +8388607	+100

This value depends on pulse scale numeration/denomination. This range is for when pulse scale numeration/denomination is 1000/1000.

■ Software Limit +

Sets the value of Software Limit for + direction.

Display	Setting Range	Default
Software Limit +	-8388608 ~ +8388607	+8388607

This value depends on pulse scale numeration/denomination. This range is for when pulse scale numeration/denomination is 1000/1000.

To function Software Limit, "Software Limit" must be enabled in mode setting. For more details, see "Software Limit" of chapter 3.1 "Mode Setting".

■ Software Limit -

Sets the value of Software Limit for -direction.

Display	Setting Range	Default
Software Limit -	-8388608 ~ +8388607	-8388607

This value depends on pulse scale numeration/denomination. This range is for when pulse scale numeration/denomination is 1000/1000.

To function Software Limit, “Software Limit” must be enabled in mode setting. For more details, see “Software Limit” of chapter 3.1 “Mode Setting”.

■ Driving End Pulse Width

Sets end pulse width for end pulse output from nDRIVE/END signal of I/F connecter at the end of driving.

Display	Setting Range	Default
End Pulse Width (msec)	1~65535 (msec)	100

To function End Pulse Width, “End Pulse” must be enabled in mode setting. For more details, see “End Pulse” of chapter 3.1 “Mode Setting”.

■ Pulse Scale Numeration

Pulse Scale Numeration is the numerator value to perform scaling for position data.

Display	Setting Range	Default
Pulse Scale numerator	1~65535	1000

Scaling function of position data is to convert to pulse value by multiplying the input/display position data by the specified coefficient. This function allows the user to handle position data in a unit of mm or inch. MR210AU/220AU converts to pulse value by multiplying the input/display position data by the following coefficient.

$$\text{Pulse Value} = \text{Input Value} \times \frac{\text{Pulse Scale Numerator}}{\text{Pulse Scale Denominator}} \quad \text{Displayed Value} = \text{Pulse Value} \times \frac{\text{Pulse Scale Denominator}}{\text{Pulse Scale Numerator}}$$

When inputting a certain position data by keys, the coefficient shown in the left formula is multiplied and then the value will be stored as pulse value in MR210AU/220AU. Also, when position data is displayed, the coefficient shown in the right formula is multiplied and then the value will be displayed.

For example, if 1 pulse of driving pulses is equivalent to 0.01mm of moving distance, to display position data in a unit of mm, set 100/1 to scale numerator/scale denominator. If input value 1 is written, it will convert to 100 pulses and 100 pulses will be displayed as 1.00. If calculation result is after the decimal point, it is rounded off up to the valid decimal place for 1 pulse and then it will be displayed.

Position data which scaling is performed is as follows:

Screen	Position Data Performed Scaling
Main Screen	Position, Preset Value
Parameter Screen	Home Search Offset, Software Limit +/-
Program Edit Screen	Position data of ABS Command and INC Command

[Note] The values of pulse scale numerator and denominator affect all the position data. Configure them at the beginning of system development based on circumstances such as motor rotation step angles or ball screw pitch. Once configure values, do not change them on the way.

The factory default of pulse scale numerator/denominator is 1000/1000, which indicates input/display equal to pulse value.

■ Pulse Scale Denomination

Pulse Scale Denomination is the denominator value to perform scaling for position data.

Display	Setting Range	Default
Pulse Scale denominator	1~65535	1000

3.3 Home Search Mode Setting

3.3.1 The Description of Home Search Operation

Home Search for MR210AU/MR220AU executes from step 1 to step 4 shown below in turn once it starts. For each step, it can be configurable for execution/non-execution, a search direction and the logical level of a detection input signal. In step 1 and 4, search operation is performed at home search high speed which is set in the parameter. In step 2 and 3, search operation is performed at home search low speed.

Step Number	Operation	Search Speed	Detection Signal
Step 1	High-speed near home search	Home search high speed	nSTOP0
Step 2	Low-speed home search	Home search low speed	nSTOP1
Step 3	Low-speed Z-phase search	Home search low speed	nSTOP2
Step 4	High-speed offset drive	Home search high speed	—

■ Step 1 High-speed Near Home Search

Driving pulse is output in the specified direction at the speed which is set in the parameter of home search high speed until near home signal (nSTOP0) becomes active. To perform high-speed search operation, set the higher value for home search high speed than initial speed. Acceleration/deceleration driving is performed and when near home signal (nSTOP0) becomes active, it stops by decelerating.

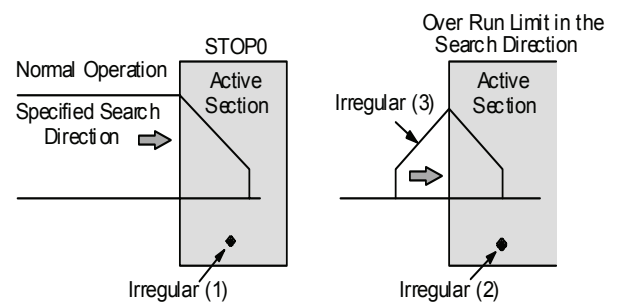

Irregular Operation

- (1) Near home signal (nSTOP0) is already active before Step 1 starts. → Proceed with Step 2.
- (2) Limit signal in the detection direction is already active before Step 1 starts. → Proceed with Step 2.
- (3) Limit signal in the detection direction is activated during execution. → Stops driving and proceed with Step 2.

■ Step 2 Low-speed Home Search

Driving pulse is output in the specified direction at the speed which is set in the parameter of home search low speed until home signal (nSTOP1) becomes active. To perform low-speed search operation, set the lower value for home search low speed than initial speed. Constant speed driving is performed and when home signal (nSTOP1) becomes active, it stops instantly.

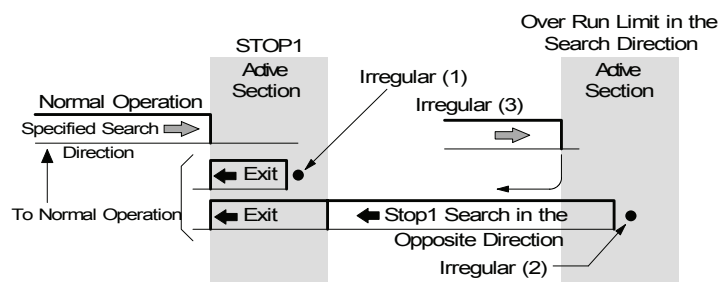

Irregular Operation

- (1) Home signal (nSTOP1) is already active before Step 2 starts.
 - The motor drives the axis in the opposite direction of the specified search direction at home search low speed until home signal (nSTOP1) becomes inactive. When home signal (nSTOP1) becomes inactive, the function executes Step 2 from the beginning.
- (2) Limit signal in the search direction is active before Step 2 starts.
 - The motor drives the axis in the opposite direction of the specified search direction at home search low speed until home signal (nSTOP2) becomes active. When home signal (nSTOP1) is active, the motor drives in the opposite direction of the specified search direction at home search low speed until home signal (nSTOP1) becomes inactive. When home signal (nSTOP1) becomes inactive, the function executes Step 2 from the beginning.
- (3) Limit signal in the search direction is activated during execution.
 - Driving stops and the same operation as (2)→ is performed.

■ Step 3 Low-speed Z-phase Search

Driving pulse is output in the specified direction at the speed which is set in the parameter of home search low speed until encoder Z-phase signal (nSTOP2) becomes active. To perform low-speed search operation, set the lower value for home search low speed than initial speed. Constant speed driving is performed and when encoder Z-phase signal (nSTOP2) becomes active, it stops instantly.

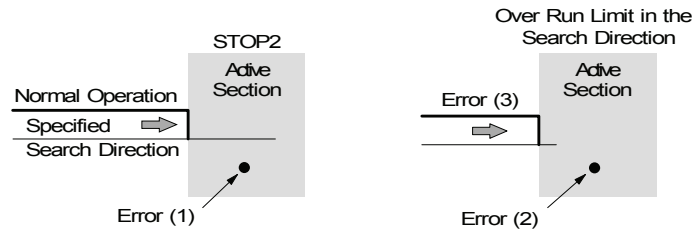

In mode setting, deviation counter clear signal (shared with nOUT0 signal) can be output for a servo motor when encoder Z-phase signal (nSTOP2) rises to active.

[Note]

- (1) If encoder Z-phase signal (nSTOP2) is already active at the start of Step 3, an error occurs and home search operation ends. Therefore, adjust the mechanical system for step 3 to always start from inactive state with a stable encoder Z-phase signal (nSTOP2).
- (2) If the limit signal in the search direction is already active before Step 3 starts, an error occurs and home search operation ends.
- (3) If the limit signal in the search direction is activated during execution, search operation aborts and home search operation ends.

■ Step 4 High-speed Offset Drive

At the speed which is set in the parameter of home search high speed, driving pulses set in home search offset are output in the specified direction. This is used when the user wants to move the axis from mechanical home position to operational home position.

After finishing Step 4, position counter is reset to 0 (can be disabled in mode setting.) and home search operation ends.

3.3.2 Home Search Mode Setting

Click **Home Search Mode** tab to change Home Search Mode screen if not displayed. MR210AU has X-axis only.

	Xaxis	Yaxis
Near Home Signal Level (STOP0)	Low	Low
Home Signal Level (STOP1)	Low	Low
Encoder Z-phase Signal Level (STOP2)	Low	Low
Step 1 Enable/Disable	Enable	Enable
Step 1 Search Direction	+	+
Step 2 Enable/Disable	Disable	Disable
Step 2 Search Direction	-	-
Step 3 Enable/Disable	Enable	Enable
Step 3 Search Direction	-	-
Step 4 Enable/Disable	Enable	Enable
Step 4 Search Direction	+	+
Position Counter Clear	Enable	Enable
Using Over Limit Signal	Disable	Disable
Deviation Counter Clear Enable/Disable	Disable	Disable
Deviation Counter Clear Level	0	0
Deviation Counter Clear Pulse Width	10	10

■ Near Home Signal Level (STOP0)

Sets an active logical level for near home signal (nSTOP0) detected in step 1.

Display	Option	Default
Near Home Signal Level (nSTOP0)	Low (GEX Short-circuited) / High (Open)	Low

Near home signals (nSTOP0) of each axis are the #11 pins in CN4, 5 connectors (See chapter 8.).

When an active logical level is set to low, detection operation of step 1 starts and when the signal becomes short-circuiting with GEX, the operation takes the signal as active and then it stops by decelerating. When set to high, and when the signal becomes open, the operation takes it as active and then it stops by decelerating.

■ Home Signal Level (STOP1)

Sets an active logical level for home signal (nSTOP1) detected in step 2.

Display	Option	Default
Home Signal Level (nSTOP1)	Low (GEX Short-circuited) / High (Open)	Low

Home signals (nSTOP1) of each axis are the #10 pins in CN4, 5 connectors (See chapter 8.).

When an active logical level is set to low, detection operation of step 2 starts and when the signal becomes short-circuiting with GEX, the operation takes the signal as active and then it stops. When set to high, and when the signal becomes open, the operation takes it as active and then it stops.

■ Encoder Z-phase Signal Level (STOP2)

Sets an active logical level for encoder Z-phase signal (nSTOP2) detected in step 3.

Display	Option	Default
Z Signal Level (nSTOP2)	Low (GEX Short-circuited) / High (Open)	Low

Encoder Z-phase signals (nSTOP2) of each axis are the #9 pins in CN4, 5 connectors (See chapter 8.).

When an active logical level is set to low, detection operation of step 3 starts and when the signal becomes short-circuiting with GEX, the operation takes the signal as active and then it stops. When set to hi, and when the signal becomes open, the operation takes it as active and then it stops.

■ Step 1~4 Enable/Disable

Sets to either Enable or Disable for each step.

Display	Option	Default
Step1 ~4 Enable	Disable (Non-execution) / Enable (Execution)	Disable

When selecting Disable (non-execution), the step is not executed and proceeds with next step. When selecting Enable (execution), search operations for each step are executed in the specified direction. See chapter 3.3.1 for more details on search operations.

■ Step 1~4 Search Direction

Specifies a detection direction for each step.

Display	Option	Default
Step1 ~4 Direction	+ / -	Step 1,2 : - Step 3,4 : +

When selecting +, as the detecting direction, driving pulses of + direction are output and when selecting -, driving pulses of - direction are output.

In high-speed offset driving of step 4, if the home offset drive value of the parameter is positive, the operation will drive in this search direction and if the home offset drive value is negative, it will drive in the opposite direction of this search direction.

■ Position Counter Clear

Clears position counter at the end of home search.

Display	Option	Default
Position Clear	Disable / Enable	Enable

■ Using Over Limit Signal

To execute home search using a + direction limit signal or a - direction limit signal, set to enable. See chapter 3.3.3 for “example of executing home search using a limit signal only”.

Display	Option	Default
Using Limit Signal	Disable / Enable	Disable

■ Deviation Counter Clear Enable/Disable

The function for deviation counter clear pulse to output when encoder Z-phase rises to active in home search operation of step 3.

Display	Option	Default
DCC Enable	Disable / Enable	Disable

Deviation counter clear pulse is output from OUT0 output signal (#5 pin) of CN4, 5 connectors. If this mode is enabled, OUT0 output signal cannot be used as general purpose output.

Deviation counter clear output becomes active at the same time as detection of Z-phase in step 3, and starts step 4 after finishing clear pulse output.

■ Deviation Counter Clear Level

Specifies a logical level for deviation counter clear pulse signal.

Display	Option	Default
DCC Level	0 (ON) / 1 (OFF)	0

When setting to 0, OUT0 output signal turns usually OFF and deviation counter clear pulse which turns ON is output.

When setting to 1, OUT0 output signal turns usually ON and deviation counter clear pulse which turns OFF is output.

[Note1] To turn OUT0 output signal ON means the output transistor of the open collector turns ON.

[Note2] The logical level is the opposite of OUT command for the driving program.

■ Deviation Counter Clear Pulse Width

Sets pulse width for deviation counter clear pulse output.

Display	Option	Default
DCC Width (μ sec)	10/20/100/200/1000/2000/ 10000/20000	10

Selects from 10 / 20 / 100 / 200 / 1000 / 2000 / 10000 / 20000 μ sec.

3.3.3 Example for Home Search Mode Setting

■ Example for execution of home search using a home signal only

Inputting a home signal to both pins STOP0 and STOP1, the user can perform a home search at high-speed by one home signal. Examples are as follows:

[Operation]

	Input Signal and Logical Level	Search Direction	Detection Speed
Step 1	STOP0, Low (GEX Short-circuited)	—	20,000pps
Step 2	STOP1, Low (GEX Short-circuited)	—	200pps
Step 3	Non-execution		
Step 4	3500 pulse offset driving in the + direction	+	20,000pps

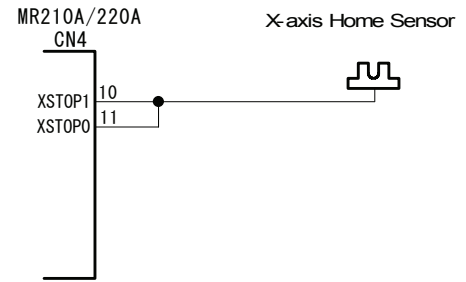

As shown in the table above, set the same logical level and search direction for step 1 and step 2.

Search a home at high-speed (20,000pps) in step 1, when the home signal becomes active, it stops by decelerating. If the stop position is within the home signal active section, the function controls to escape in the opposite direction by the irregular operation (1) of step 2 and then searches a home by operation of step 2.

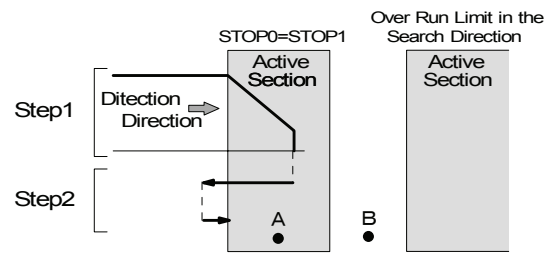

If the stop position of step 1 passed through the home signal active section, the limit in the search direction is set in step 2, in this case, irregular operation (3) will be performed.

When home search starting position is in point A as shown in the diagram, irregular operation (1) of step 2 is performed without step 1. When starting position is in point B as shown in the diagram, irregular operation (2) of step 2 is performed after the limit is set in the search direction in step 1.

[Note]

1. Make sure to set an over run limit ahead of detection direction and connect the signal to the limit input (LMT+/-).
2. Since the same signal is used in Step 1 and Step 2, the same logical level and detection direction must be applied.

[Parameter setting]

Item	Setting Value	Remark
Speed Multiplier	10	
Acceleration Rate	400	Can stop by decelerating within the home signal active section.
Start Speed	50	Start speed for trapezoidal driving.
Home Search Low Speed	20	200pps set the smaller value than the start speed.
Home Search High Speed	2000	20,000pps
Home Search Offset	3500	

[Home search mode setting]

Item	Setting Value	Remark
Near Home Signal Level(nSTOP0) logical level	Low	GEX short-circuited and active.
Home Signal Level (nSTOP1) logical level	Low	The same signal as STOP0, so the logical level is also the same as STOP0.
Z Signal Level (nSTOP2) logical level	Low	Not used.
Step 1 Enable	enable/disable	Enable
Step 1 Direction	search direction	— direction
Step 2 Enable	enable/disable	Enable
Step 2 Direction	search direction	— direction
Step 3 Enable	enable/disable	Disable

Step 3 Direction	search direction	—	
Step 4 Enable	enable/disable	Enable	Enable
Step 4 Direction	search direction	+	+ direction
Position Clear		Enable	Position counter clear after finishing home search.
Using Limit Signal		Disable	Disable
DCC Enable deviation counter clear enable		Disable	Disable (not used)
DCC Level deviation counter clear level		0	
DCC Width (μ sec) deviation counter clear width		10	

■ Example of executing home search by only limit signal

For a simple home search, the limit signal of one side is used as an alternative to home signal. However, the following two conditions are applied.

- When high-speed search operation is performed, decelerating stop must sufficiently be performed within the distance from limit signal activation position to mechanical limit position.
- Home search position cannot be beyond the limit signal active section in the search direction.

In this example, the limit signal in the –direction is used as home signal.

- Connect LMT-input to STOP0 and STOP1 input pins as shown in the diagram.
- To perform high-speed search of Step 1, set a limit stop mode to decelerating stop.
- Set the same logical level for the LMT-, STOP0, and STOP1 signals.
- Enable Using Limit Signal (using over run limit) of home search mode.
- Execute Step 4 (offset driving) to escape from the limit.

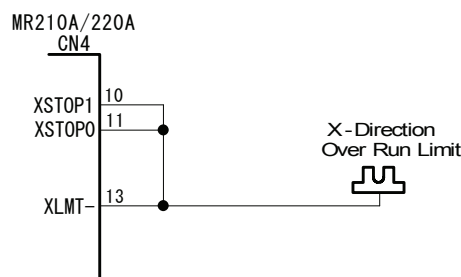

[Operation]

	Input signal and logical level	Search Direction	Search Speed
Step 1	STOP0, Low (GEX Short-circuited)	—	10,000pps
Step 2	STOP1, Low (GEX Short-circuited)	—	200pps
Step 3	Non-execution		
Step 4	500 pulse offset driving in the + direction.	+	10,000pps

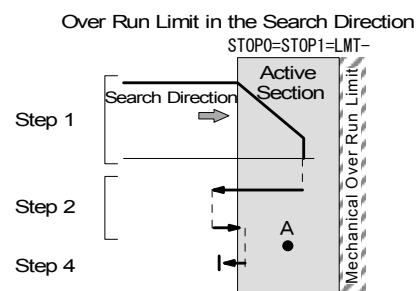

The axis drives up to the limit at high-speed in the –direction in Step 1. When the – limit signal becomes active, the function stops operation by decelerating and advances to Step 2. The function exits control from the limit in the opposite direction by irregular operation (2) of Step 2 and stops operation when Limit Signal Active is detected at low-speed in the search direction. When the home search starting position is within the limit (point A in the diagram above), the function starts from Step 2 without execution of Step 1. The function finishes at the out of the limit active section by offset driving in the opposite direction in Step 4.

[Note]

1. The same search direction must be applied for Step 1 and Step 2.
2. Step 4 must be enabled and applied to the direction opposite to Step 1 and 2. Make sure that home search operation finishes at the out of the limit active section.
3. When enabling Step 3, apply the direction opposite to Step 1 and 2.
4. Limit stop mode should be set to decelerating stop.

[Mode setting]

Item	Setting Value	Remark
Limit Stop Mode	Slow	Selects a decelerating stop.
Limit Active Level limit signal logical level	Low	

[Parameter setting]

Item	Setting Value	Remark
Speed Multiplier	10	
Acceleration Rate	400	Can stop by decelerating within the limit signal active section.
Start Speed	50	Start speed for trapezoidal driving.
Home Search Low Speed	20	200pps set the smaller value than the start speed.
Home Search High Speed	1000	10,000pps
Home Search Offset	500	Need the distance to escape from the limit active section.

[Home search mode setting]

Item	Setting Value	Remark
Near Home Signal Level(nSTOP0) logical level	Low	The same logical level as the limit signal since the limit signal is used.
Home Signal Level (nSTOP1) logical level	Low	same as above.
Z Signal Level (nSTOP2) logical level	Low	Not used.
Step 1 Enable enable/disable	Enable	Enable
Step 1 Direction search direction	—	— direction
Step 2 Enable enable/disable	Enable	Enable
Step 2 Direction search direction	—	— direction
Step 3 Enable enable/disable	Disable	Disable
Step 3 Direction search direction	—	
Step 4 Enable enable/disable	Enable	Enable (escape from the limit)
Step 4 Direction search direction	+	+ direction
Position Clear	Enable	Position counter clear after finishing home search.
Using Limit Signal	Enable	Enable
DCC Enable deviation counter clear enable	Disable	Disable (not used)
DCC Level deviation counter clear level	0	
DCC Width (μ sec) deviation counter clear pulse width	10	

4. Driving Program

The user can program to a maximum of 64 steps in REG0~63 of X and Y axes in MR220AU and MR210AU (MR210AU has only X axis.). Programs can be executed by any register number, therefore, the user can make multiple programs in 64 registers.

To write the driving program, connect MR210AU/MR220AU and PC with the RS232C or USB cable and **start the operating program** on Windows, then open the program edit screen. In addition, the user can use an optional remote box (MR200RB), which connects to the RS232C port of the motor control unit. See chapter 7 for details on how to write by the remote box. To execute the user program,

- (1) Execute from main screen—operating program on PC. See chapter 6.2.
- (2) Execute from parallel I/F. See chapter 5.5.
- (3) Execute from the remote box See chapter 7.2.

there are three ways as above. Please refer to each chapter.

Start Operating Program

Connect MR210AU/220AU and PC with the cable and then start the operating program. (See chapter 6.1 for details on how to start the operating program.) When the main screen appears, click **Program Edit** button. Program Edit screen appears.

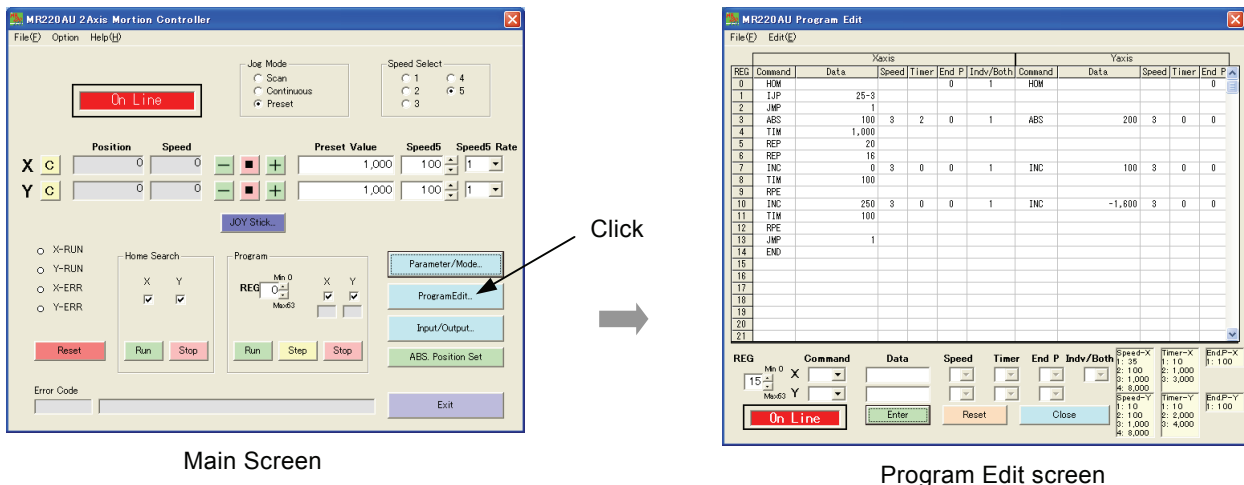

Main Screen

Program Edit screen

Please refer to chapter 6.4 for operating details on program edit screen. This chapter describes each command of the program.

4.1 Driving program commands

12 commands for the driving program are prepared as follows:

Command Type	Code	Contents
Drive Commands	ABS	Absolute Position Move
	INC	Relative Position Move
	HOM	Home Search
I/O Commands	IJP	Input Condition Jump
	OUT	Output Port ON / OFF
	OTP	Output Port ON Pulse
Program Control Commands	JMP	Jump
	REP	Repetition Start
	RPE	Repetition End
	END	Program End
Other Commands	TIM	Timer
	NOP	No Operation

Each command is described as below.

ABS Absolute Position Move

CMD	Data	SPD	TIM	END.P	Both
ABS	Absolute Position (-8388608 ~ +8388607)	1~4	0~3	0/1	0/1

The axis moves from the current position to the absolute position specified by Data.

- Data:** Specifies the destination position by absolute value.
This value can be placed in a unit of mm or inch when the pulse scale numeration/denomination (see chapter 3.2.) are set. Factory default is pulse scale numeration=denomination, so it is pulse value. The setting range in pulse value is from -8388608 ~ +8388607.
- SPD:** Selects drive speed for moving. Drive speed 1~4 are registered by the parameter (see chapter 3.2.).
- TIM:** Specifies the waiting time until the next register is executed after completion of moving. When 1~3 is assigned to TIM, the time of post timer 1~3, which is registered in the parameter (see chapter 3.2), is used. When setting without the waiting time, set 0 to TIM.
- END.P:** When 1 is set, after moving, the driving end pulse will be output to nDRIVE/END output signal of the parallel I/F. However, Driving End Pulse must be set to Enable in mode setting and End Pulse Width must be set in parameter setting.
- Both:** Set 0 when operating X axis independently. Set 1 when starting X and Y axes together and waiting for drive stop together. This Both is applied to ABS, INC and HOM commands of X axis only. When setting Both=1, write the same command to the same register number of Y axis and write the position data for Y axis.

[Notes for Both]

“Both” is the function to move X and Y axes simultaneously. Even if one axis finishes moving first, next register (step) will be executed after another axis finishes moving. To use “Both” function, please note the following:

- When Both=1 is set by ABS, INC and HOM commands of X axis, the same command as X axis must be set to the same register number of Y axis.
- When the drive of Y axis is activated by “Both” function during execution of the program, and if Y axis is already driven by the independent driving program of Y axis, a runtime error occurs. Therefore, when using “Both” function, be careful not to occur the conflict to driving of Y axis. Basically, do not start the program of Y axis when using “Both” function.

INC Relative Position Move

CMD	Data	SPD	TIM	END.P	Both
INC	Relative Position (-8388608 ~ +8388607)	1~4	0~3	0/1	0/1

The axis moves from the current position to the relative position specified by Data.

- Data:** Specifies the destination position by relative value to the current position.
This value can be placed in a unit of mm or inch when the pulse scale numeration/denomination (see chapter 3.2.) are set. Factory default is pulse scale numeration=denomination, so it is pulse value. The setting range in pulse value is from -8388608 ~ +8388607.
- SPD:** Selects drive speed for moving. Drive speed 1~4 are the speed registered by the parameter (see chapter 3.2.).
- TIM:** Specifies the waiting time until next register is executed after completion of moving. When 1~3 is assigned to TIM, the time of post timer 1~3, which is registered in the parameter (see chapter 3.2), is used. When setting without the waiting time, set 0 to TIM.
- END.P:** When 1 is set, after moving, the driving end pulse is output to nDRIVE/END output signal of the parallel I/F. However, Driving End Pulse must be set to Enable in mode setting and End Pulse Width must be set in parameter setting.

Both: Set 0 when operating X axis independently as INC. Set 1 when starting X and Y axes together then waiting for drive stop together. This **Both** is applied to ABS, INC and HOM commands of X axis only. When **Both**=1 is set, write the same command to the same register number of Y axis and write the position data for Y axis. Please see **Notes for Both** in ABS.

HOM Home Search

CMD	Data	SPD	TIM	END.P	Both
HOM		—	—	0/1	0/1

Executes a home search according to the procedures set by home search mode.

END.P: When 1 is set, driving end pulses are output to nDRIVE/END output signal of the parallel I/F after completion of the home search. However, Driving End Pulse must be set to Enable in mode setting and End Pulse Width must be set in parameter setting.

Both: Set 0 when executing a home search to X axis independently. Set 1 when starting X and Y axes together then waiting for drive stop together. This **Both** is applied to ABS, INC and HOM commands of X axis only. When **Both** = 1 is set, write the same command to the same register number of Y axis. Please see **Notes for Both** in ABS.

IJP Input Condition Jump

CMD	Data1	Data2
IJP	Input Port Number	Register Number to Jump

PC programming format	
Command	Data
IJP	<input type="text" value="Input Port Number"/> — <input type="text" value="Register Number to Jump"/>

When the specified input port is Low (GEX short-circuited), it jumps to the specified register. When not Low (Open), it moves to next register.

Data1: Specifies the input port number corresponding to the input signal. See chapter 4.2 for input port numbers.

Data2: Specifies the register number to jump. The range is from 0 to 63.

OUT Output Port ON / OFF

CMD	Data1	Data2
OUT	Output Port Number	0 (OFF) / 1 (ON)

PC programming format	
Command	Data
OUT	<input type="text" value="Output Port Number"/> — <input type="text" value="0 / 1"/>

Turn the specified output port ON (turn open collector transistor ON) and OFF (turn open collector transistor OFF).

Data1: Specifies the output port number corresponding to the output signal. See chapter 4.2 for output port numbers.

Data2: When setting 0, the output port turns OFF and when setting 1, it turns ON.

OTP Output Port ON Pulse

CMD	Data1	Data2
OTP	Output Port Number	ON Time (msec)

PC programming format	
Command	Data
OUT	<input type="text" value="Output Port Number"/> — <input type="text" value="ON Time"/>

Turn the specified output port ON (turn open collector transistor ON) for specified period.

Data1: Specifies the output port number corresponding to the output signal. See chapter 4.2 for output port numbers.

Data2: Specifies the time to maintain ON in a unit of msec. The range is from 0 to 65535 msec.

JMP Jump

CMD	Data
JMP	Register Number to Jump

Jumps to the specified register.

Data: Specifies the register number to jump. The range is from 0 to 63.

REP Repetition Start

CMD	Data
REP	Repetition Numbers

Repeat specified times from next register of this command to Repetition End command (RPE).

Data: Specifies the repetition numbers. The range is from 1 to 255.

Repetition End command (RPE) must be placed under this Repetition Start command (REP) (larger register number). Repetition loop can be nested up to 3 hierarchies.

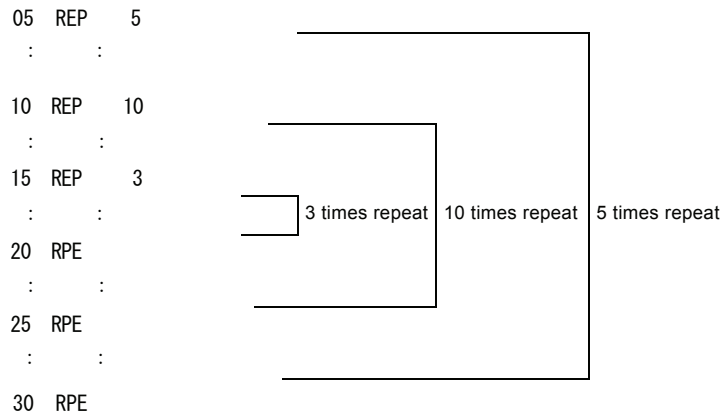

RPE Repetition End

CMD	Data
RPE	—

Repeat specified times from Repetition Start command (REP) to this command.

END Program End

CMD	Data
END	—

Terminates the program. This command must be written at the end of the program.

TIM Timer

CMD	Data
TIM	Waiting Time (msec)

Waits for the specified period.

Data: Specifies the waiting time in a unit of msec. The range is from 0 to 65535 msec.

NOP No Operation

CMD	Data
NOP	—

No operation is performed.

4.2 Input/Output Ports

■ Input Ports

Input Port Number	Connector	Pin Number	Signal	Signal Description	Signal Category
0	CN4	11	XSTOP0	Near Home	X axis Signals
1	CN4	10	XSTOP1	Home	
2	CN4	9	XSTOP2	Encoder Z-phase	
3	CN4	6	XINPOS	Servo Positioning Completion	
10	CN5	11	YSTOP0	Near Home	Y axis Signals
11	CN5	10	YSTOP1	Home	
12	CN5	9	YSTOP2	Encoder Z-phase	
13	CN5	6	YINPOS	Servo Positioning Completion	
20	CN3	6	REGSL0	REGSL Signal	Parallel I/F Signals
21	CN3	7	REGSL1		
22	CN3	8	REGSL2		
23	CN3	9	REGSL3		
24	CN3	10	REGSL4		

When using MR210AU, 10~13 is not available.

■ Output Ports

Output Port Number	Connector	Pin Number	Signal	Signal Description	Signal Category
0	CN4	5	XOUT0	General Purpose Output X axis 0	X axis Signal
10	CN5	5	YOUT0	General Purpose Output Y axis 0	Y axis Signal

When using MR210AU, 10 is not available.

5. Driving by parallel I/F

Parallel I/F connector is the P I/F connector (CN3) on front panel. See chapter 8.3 for details on I/O pin assignments or I/O circuit. Connect this parallel interface and a PLC or mechanical contacts, and the user can operate MR220AU/210AU as shown in the table. Each drive except for home search execution can be selected by MODE0, 1 (12, 13) signals.

Driving	Operation	MODE1	MODE0
Home Search Execution	Executes home search according to configured home search mode.	—	—
Index Driving	Specifies the register number and then executes registered ABS, INC commands.	OFF	OFF
Scan Driving	Drives the axis while input signal is ON.	OFF	ON
Continuous Driving	Drives the axis continuously.	ON	OFF
Program Driving	Executes the registered driving program.	ON	ON

Hereinafter, each operation will be described. In this manual, input signal ON means that the signal is short-circuited with GEX and OFF means that the signal is open. Output signal ON/OFF means that open collector transistor turns ON/OFF. The number in () after the signal indicates the pin number.

5.1 Home Search Execution

Home search starts when the user turns ON the axis designation signal (X:4, Y:5) and HOME (2) input signal is ON for more than 10msec. The figure below shows an example for a home search of X axis only. Once home search starts, nDRIVE/END (14, 15) output signal of running axis turns ON, and when finished home search, it turns OFF. However, if driving end pulse is enabled by mode setting, nDRIVE/END output signal keeps OFF during execution of home search, and ON pulses will be output for the period of the End Pulse Width at the end of driving.

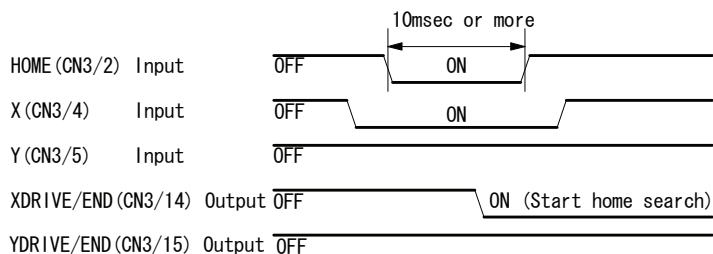

[Note]

- Software limit is ignored during execution of home search even if enabled.
- In MR210AU, the axis designation specifies X axis.
- X, Y DRIVE/END signals will be OFF after HOME signal returns to OFF.

5.2 Index Driving

Index driving functions to execute registered ABS, INC commands.

Set the following three items using the input signal of P I/F connector (CN3) and turns STROBE (3) drive start strobe ON, and the driving will start.

Designation Item	Input Signal Setting of CN3
Operation Mode: Index Mode	MODE0(12) = OFF, MODE1(13) = OFF
Axis	X(4),Y(5) = Set On the axis which the user wants to execute.
Register Number	REGSL0(6)~REGSL5(11) Please refer to Register Number Designation Table

Register Number Designation Table

REG Number	REGSL0~5 Input Signal Setting					
	REGSL0(6)	REGSL1(7)	REGSL2(8)	REGSL3(9)	REGSL4(10)	REGSL5(11)
0	OFF	OFF	OFF	OFF	OFF	OFF
1	ON	OFF	OFF	OFF	OFF	OFF
2	OFF	ON	OFF	OFF	OFF	OFF
:	:	:	:	:	:	:
16	OFF	OFF	OFF	OFF	ON	OFF
:	:	:	:	:	:	:
63	ON	ON	ON	ON	ON	ON

The example for execution of X axis index driving is shown as follows:

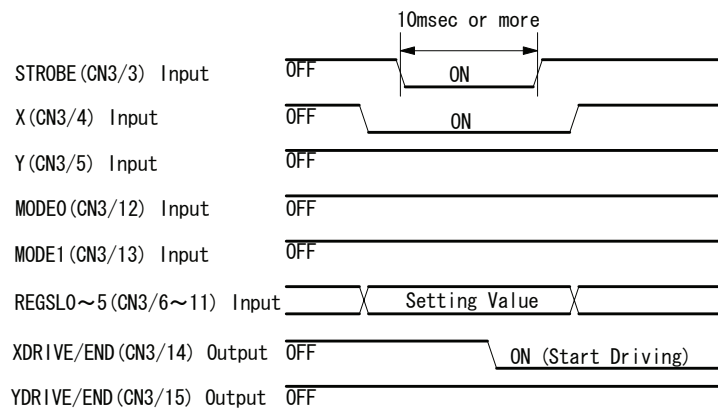

STROBE signal must keep ON for more than 10msec. In MR210AU, signal of Y axis (Y axis Input CN3/5pin, Y axis Drive CN3/15pin) is disabled.

5.3 Scan Driving

Scan driving outputs pulses in the + or – direction while the input signal is ON. Drive speed can be selected from Drive Speed 1~4 by SPD0, 1 (8, 9) input signals.

Scan driving has two operational modes, one is the Scan Driving 1 which cannot drive 2 axes individually, and another is the Scan Driving 2 which can drive 2 axes individually.

■ Scan Driving 1

Scan driving 1 drives in the + or – direction respectively with axis designation signal (X:4, Y:5) while RUN+/- (6, 7) input signals are ON. Therefore, the user cannot drive X and Y axes individually. Set the following four items by the input signal, and driving pulse is output in the + direction while RUN+ (6) is ON and in the –direction while RUN- (7) is ON.

Designation Item	Input Signal Setting of CN3
Operation Mode: Scan Mode	MODE0(12) = ON, MODE1(13) = OFF
Scan Driving 1	SCAN(10) = OFF
Axis	X(4),Y(5) = Turn On the axis which the user want to execute.
Drive Speed	SPD0(8)~SPD1(9) Please refer to Drive Speed Designation.

Drive Speed Designation

Drive Speed	SPD1(9)	SPD0(8)
Drive Speed 1	OFF	OFF
Drive Speed 2	OFF	ON
Drive Speed 3	ON	OFF
Drive Speed 4	ON	ON

[Note] If drive speed designation is changed during driving, Drive Speed changes immediately. Drive Speed can be Changed with Serial Communication Command (or from Main Operation Window) during driving with Parallel Interface. So if Drive Speed is changed with Parallel Interface and Serial Communication Command, the actual Driving Speed is different from the commanded one with Parallel Interface. The example is as follows;

- Set Drive Speed 1 with Parallel Interface and start driving : It drives at Drive Speed 1
- Set Drive Speed 3 from Main Operation Window: It drives at Drive Speed 3
- Set Drive Speed 3 with Parallel Interface once in order to return Drive Speed 1: It drives at Drive Speed 3
- Set Drive Speed 1 with Parallel Interface: It drives at Drive Speed 1

■ Scan Driving 2

Scan driving 2 can operate X and Y axes individually. Set the following three items by the input signal.

Designation Item	Input Signal Setting of CN3
Operation Mode: Scan Mode	MODE0(12) = ON, MODE1(13) = OFF
Scan Driving 2	SCAN(10) = ON
Drive Speed	SPD0(8)~SPD1(9) Please refer to Drive Speed Designation.

Driving pulses are output to each axis in each direction while the input signal below is ON.

Axis and Direction for Scan Driving	Input Signal to turn ON
X axis +Direction	SCANX+(6)
X axis -Direction	SCANX-(7)
Y axis +Direction	SCANY+(4)
Y axis -Direction	SCANY-(5)

[Note] Do not perform a home search by HOME (2) signal when scan driving 2 is selected.

5.4 Continuous Driving

Continuous driving outputs pulses in the + direction when RUN+ (6) input signal is ON, and in the - direction when RUN- (7) input signal is ON, which keeps output until STOP (11) input signal turns ON. (When LIMIT input signal in the current direction becomes active, it stops.) Drive speed can be selected from Drive Speed 1~4 by SPD0, 1 (8, 9) input signals. If drive speed is changed during driving, it immediately shifts to the changed speed.

Designation Item	Input Signal Setting of CN3
Operation Mode: Continuous Mode	MODE0(12) = OFF, MODE1(13) = ON
Axis	X(4),Y(5) = Turn On the axis which the user want to execute continuously.
Drive Speed	SPD0(8)~SPD1(9) Please refer to Drive Speed Designation in chapter 5.3.

5.5 Program Driving

Registered driving programs are executed. Set the following three items by the input signal of P I/F connector (CN3) and turn STROBE (3) drive start strobe ON, and driving will start.

Designation Item	Input Signal Setting of CN3
Operation Mode: Program Mode	MODE0(12) = ON, MODE1(13) = ON
Axis	X(4),Y(5) = Turn On the axis which the user want to execute.
Register Number	REGSL0(6)~REGSL5(11) Please refer to Register Number Designation in chapter 5.2.

6. Operation by PC

Connect MR210AU/220AU and PC with the accessory cable and start the operating program, the user can perform the following operations.

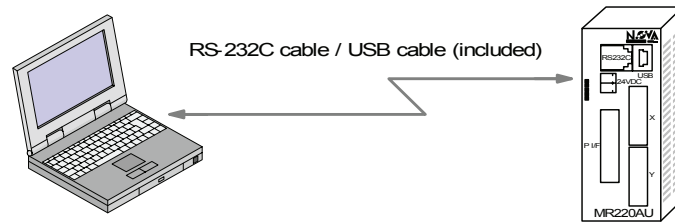

Screen	Operation
Main Screen	Jog mode for each axis (Scan, Continuous, Preset) Home search, Index driving, Program execution Save and Load of Operating mode, Parameters and Program files
Parameter / Mode Screen	Mode Parameter Home search mode
Program Edit Screen	Driving program editing
Input / Output Screen	Status display of input signals, setting of output signals

These operations will be described below in order of screen on Windows.

6.1 Start Operating Program

Start the operating program on your PC according to the following steps.

(1) Connect the motor control unit and PC with the RS232C or USB cable. Be sure not to connect with both cables.

(2) Turn on both equipment power.

If this is first connection with the USB cable, new hardware will be detected. Insert MR210A/220A CD-ROM into the CD drive and install USB device driver. See chapter 2.

(3) Start the operating program from [Start] button.

On the Start menu, point to Programs, then click Motion Controller → MR220A → MR220A

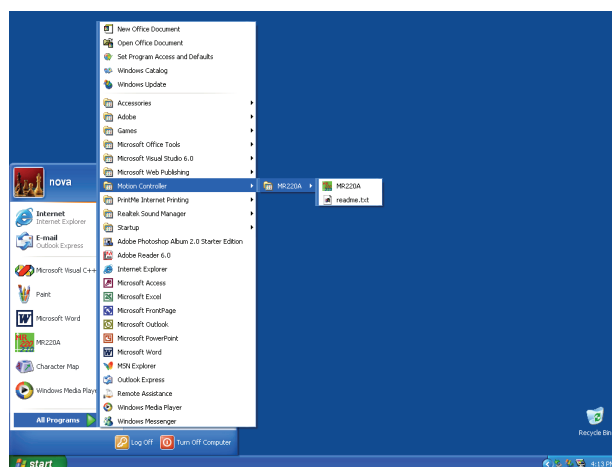

If the connection is correctly established, all the data registered in the motor control unit (driving mode/parameters and driving programs) will be uploaded onto your PC and main screen appears.

If the connection is not established, the following message appears.



Click OK, and the operating program starts in “Off Line”. Select either MR210A or 220A, and main screen appears.

[Note] When the operating program is first started after installation, it may be offline mode occasionally even though the cable is connected. In this case, click **Option** menu on the upper left of the main screen, then check (V) **COM** option connected with the motor control unit, then exit the operating program and restart it.

When connecting with the USB cable, click Control Panel → System → Hardware tab → Device Manager, the user can find the COM port number after USB device driver name (“USB to Serial Port”) under Ports (COM & LPT).

6.2 Main Screen

When starting the operating program, the following main screen appears. In this screen,

- Jog mode for each axis (Scan, Continuous, Preset)
- Home search, Index driving, Program execution
- Save and Load of Operating mode, Parameters and Program files

the user can perform operations as above.

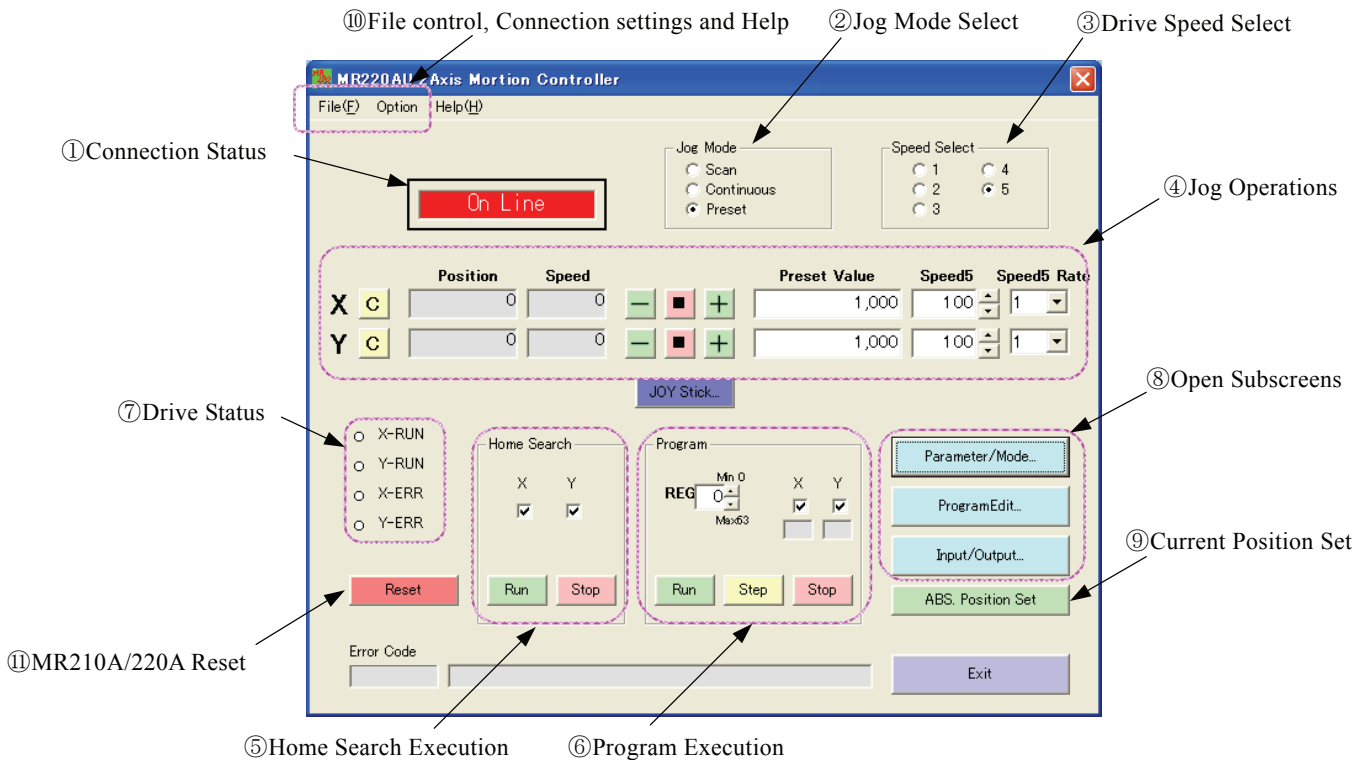



① Connection Status

When “On Line” is displayed, the connection is established with the motor control unit by serial communication. When “Off Line” is displayed, the connection is not established; however, the user can also create driving programs in off line. In this case, use Open/Save on the File menu for file reading and saving from/to hard disc.

② Jog Mode Select

There are three modes can be set in main screen.

Display	Contents
Scan	Drives only while pressing the direction button   .
Continuous	Starts to drive when the direction button is pressed and keeps driving until Stop button  is pressed.
Preset	Drives for Preset Value when the direction button is pressed.









③ Drive Speed Select

Select drive speed for jog mode. Speed 1~4 are the drive speed 1~4 configured by parameter screen. Speed 5 is the speed configured in “Speed5” of main screen. The user can change Speed Select during driving.

[Note] Although driving is commanded from Main Operation Window (or Serial Communication Command), Drive Speed can be changed with the command of Parallel Interface. So if Drive Speed is changed with Parallel Interface and Main Operation Window, the actual Driving Speed is different from the commanded one from Main Operation Window. The example is as follows;

- Set Drive Speed 1 from Main Operation Window and start driving: It drives at Drive Speed 1.
- Set Drive Speed 3 with Parallel Interface: It drives at Drive Speed 3.

④ Jog Operations

Display	Operation
 button	Clicking the button outputs drive pulses in the + direction.
 button	Clicking the button outputs drive pulses in the - direction.
 button	Clicking the button stops driving.
Preset Value	Set the driving pulse for Preset. This value depends on the scaling function. See “Pulse Scale Numeration” in chapter 3.2.
Speed 5	Set the speed for Speed5. Setting range: 1~8000 Clicking ( ) button on the right increases and decreases the setting value depending on Speed5 Rate. Actual speed for drive pulse output is the value which multiplies this setting value by speed multiplier (See Parameter Setting). When speed 5 is selected by Speed Select, the user can change drive speed by changing the value of Speed5 during driving.
Speed 5 Rate	Select the rate for Speed5. For instance, if 10 is selected, clicking ( ) button increases and decreases the value of Speed5 ten at a time.
Position	Displays the current position. It is indefinite at power-on. When completing the home search, 0 is displayed. Clicking clear button  clears the current position at any position. This value depends on the scaling function. See “Pulse Scale Numeration” in chapter 3.2.
Speed	Displays the current speed during driving.
 button	Clicking resets Position (the current position) to 0.

■ JOY Stick

Click **JOY Stick** button on main screen, and the following window appears. The JOY Stick can configure the placement of X+, X-, Y+, Y- keys. In addition, the user can drive X and Y axes simultaneously.

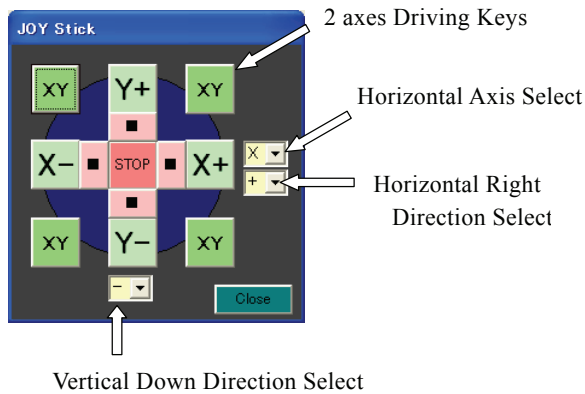

Horizontal Axis Select	Selects horizontal axis either X or Y.
Horizontal Right Direction Select	Selects horizontal right direction either + or -.
Vertical Down Direction Select	Selects vertical down direction either + or -.
2 axes Driving Keys	Drives X and Y axes simultaneously.
■	Stops driving of 1-axis.
STOP	Stops driving of all axes.

⑤ Home Search Execution

The frame of home search execution for each axis. Home search mode and speed must be set in Parameter / Mode screen in advance.

Display	Operation
X, Y	Selects the axis to execute home search.
Run	Clicking the button starts home search.
Stop	Clicking the button aborts home search.

⑥ Program Execution

The frame of the program execution. The program must be created in Program Edit screen in advance. In addition, necessary items must be set in Parameter / Mode screen.

Display	Operation
REG	Set REG number to be executed.
X, Y	Set the axis to be executed.
Run	Clicking the button starts programs from the REG number.
Step	Clicking the button executes the step at the REG number. Only ABS, INC, HOM, OUT and OTP commands are available.
Stop	When clicking the button after a click of Run , the program step now executed becomes PAUSE. Then if Stop is clicked again, the program is aborted. If Run is clicked, the program proceeds. This Stop button is disabled after a click of Step .

[Note] Do not change the program and parameter/mode while running the program.

⑦ Drive Status

Display	Operation
n-RUN	The red light turns on while the axis is driving. The light always turns on while the axis is executing a program.
n-ERR	The light turns on when limit over or servo alarm occurs. When an error occurs, the error message is displayed at the bottom of the screen.

⑧ Open Sub screens

Display	Operation
Parameter/Mode	Open Parameter/Mode screen.
Program Edit	Open Program Edit screen.
Input/Output	Open Input/Output screen.

⑨ Current Position Set

The current position displayed in “Position” is set to “REG” of the program execution frame in the form of ABS command. Only the axis checked in the program execution frame is applied.

- Drive speed sets the value selected by “③ Drive Speed Select”. However, if speed 5 is selected, it sets Speed 4.
- 0 is set to TIM and END.P.
- 1 is set to Both when X and Y axes are selected together; otherwise, 0 is set. If the current position set completes, REG in the program execution frame is incremented by one.

⑩ File Control and Connection Settings

File control has the following functions. The transferred data is setting values in Parameter/Mode screen and programs in Program Edit screen. The user can transfer all the data or some of the data to the motor control unit.

File Menu	Function	Contents
Open	File Readout	Data is read from the file on disc. When in online, reading data is written to the motor control unit automatically. File extension is “nvd”.
Save	File Save	Data is saved on disc with a file name. File extension is “nvd”.
Upload	Reads from MR210AU/MR220AU	Data is read from the motor control unit. All All the data Program-All All the programs Program-Xaxis X-axis program data Program-Yaxis Y-axis program data Parameter-All All the data of Parameter/Mode Parameter-Xaxis X-axis Parameter/Mode data Parameter-Yaxis Y-axis Parameter/Mode data [Note] Data is automatically uploaded when the operating program starts in online mode.
Download	Writes to MR210AU/MR220AU	Data is written to the motor control unit. All All the data Program-All All the programs Program-Xaxis X-axis program data Program-Yaxis Y-axis program data Parameter-All All the data of Parameter/Mode Parameter-Xaxis X-axis Parameter/Mode data Parameter-Yaxis Y-axis Parameter/Mode data [Note] When data is written or changed in Parameter/Mode or Program Edit screens in online mode, data is automatically written to the motor control unit each time, so usually no need to download them.

In Option menu, the user can select a serial communication port or communication speed. The communication ports be currently available are displayed by COM number. If the COM port connected to the motor control unit is not checked (V), the connection cannot be established, so check it. When using USB communication and COM number is unknown, confirm COM number with Windows Device Manager as follows:

Click Control Panel → System → Hardware tab → Device Manager, and find COM number of “USB-to-Serial Port” under Ports (COM & LPT).

Communication speed can be selected within the range from 9600bps to 38400bps. The initial value is 9600bps. If the user speeds up the communication speed, the motor control unit responds quickly but is affected by noise.

Help menu shows the versions of the motor control unit and operating program. The upper part indicates the motor control unit (Version: *****), and the lower part indicates the operating program (Version of app: *****).

⑪ MR210AU/220AU Reset

Resets the MR210AU/220AU.

6.3 Parameter / Mode Screen

The user can configure mode, parameter and home search settings in Parameter / Mode screen.

6.3.1 Mode Tab

Configures modes for driving. Each mode can be selected from a list by click (▼). When each value is written or changed in online mode, data is automatically downloaded to the motor control unit.

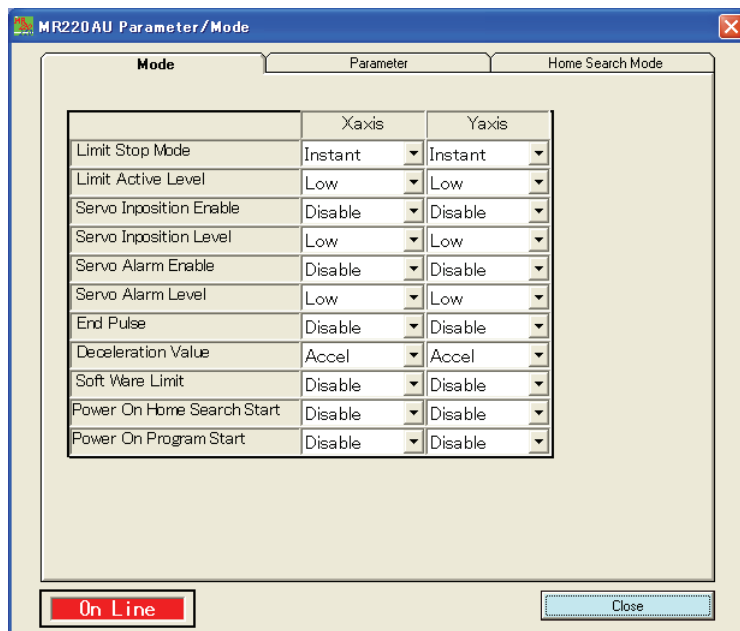

Setting items in Mode tab are as follows. See chapter 3.1 for more details on each mode.

Display	Contents	Option	Default
Limit Stop Mode	Limit stop mode	Instant/Slow	Instant
Limit Active Level	Limit signal logical level	Low/High	Low
Servo Inposition Enable	Servo positioning completion enable	Disable/Enable	Disable
Servo Inposition Level	Servo positioning completion enable logical level	Low/High	Low
Servo Alarm Enable	Servo alarm enable	Disable/Enable	Disable
Servo Alarm Level	Servo alarm enable logical level	Low/High	Low
End Pulse (100msec)	Driving end pulse	Disable/Enable	Disable
Deceleration Value	Deceleration value select	Accel/Decel	Accel
Soft Ware Limit	Software limit enable	Enable/Disable	Disable
Power On Home Search Start	Power on home search automatically start	Enable/Disable	Disable
Power On Program Start	Power on program automatically start	Enable/Disable	Disable

6.3.2 Parameter Tab

Configures parameters for driving. The user can set parameters for X and Y axes respectively. A configurable range is each displayed in “Range of Value”. When each value is written or changed in online mode, data is automatically downloaded to the motor control unit.

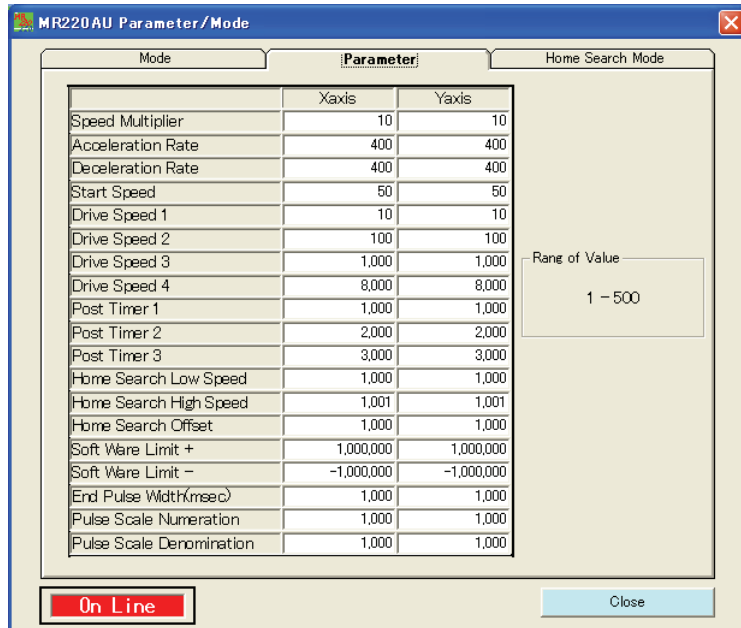

Setting items in Parameter tab are as follows. See chapter 3.2 for more details on each parameter.

Display	Range	Default
Speed Multiplier	1~500	10
Acceleration Rate	1~8000	400
Deceleration Rate	1~8000	400
Start Speed	1~8000	50
Drive Speed 1	1~8000	10
Drive Speed 2	1~8000	100
Drive Speed 3	1~8000	1000
Drive Speed 4	1~8000	8000
Post Timer 1	1~65535 (msec)	10
Post Timer 2	1~65535 (msec)	100
Post Timer 3	1~65535 (msec)	1000
Home Search Low Speed	1~8000	20
Home Search High Speed	1~8000	1000
Home Search Offset	-8388608~+8388607 Note1	+100
Soft Ware Limit +	-8388608~+8388607 Note1	+8388607
Soft Ware Limit -	-8388608~+8388607 Note1	-8388608
End Pulse Width(msec)	1~65535 (msec)	100
Pulse Scale Numeration	1~65535	1000
Pulse Scale Denomination	1~65535	1000

Note1: when pulse scale denomination=pulse scale numeration.

6.3.3 Home Search Mode Tab

Configures modes for home search. Each mode can be selected from a list by click (▼). When each value is written or changed in online mode, data is automatically downloaded to the motor control unit.

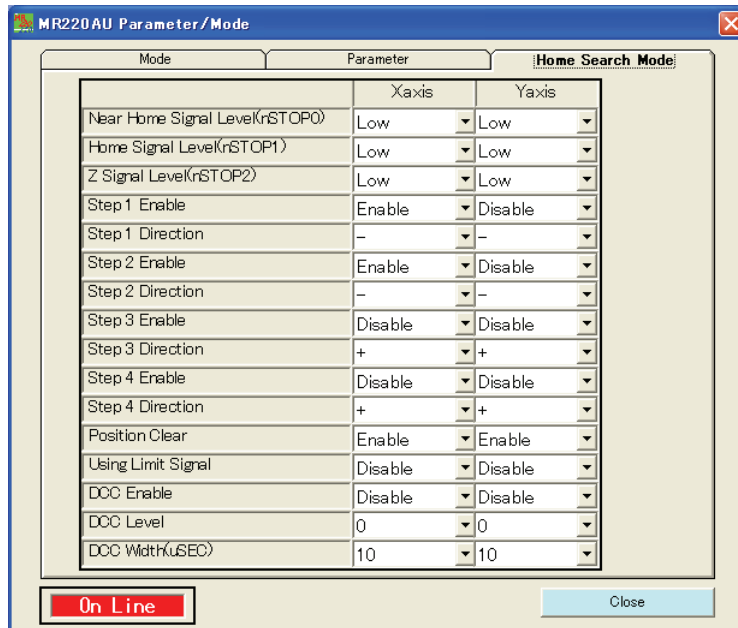

Setting items in Home Search Mode tab are as follows. See chapter 3.3 for more details on each mode.

Display	Contents	Option	Default
Near Home Signal Level (nSTOP0)	Near home signal (STOP0) logical level	Low/High	Low
Home Signal Level (nSTOP1)	Home signal (STOP1) logical level	Low/High	Low
Z Signal Level (nSTOP2)	Encoder Z-phase signal (STOP2) logical level	Low/High	Low
Step 1 Enable	Step 1 enable/disable	Disable/Enable	Disable
Step 1 Direction	Step 1 search direction	+/-	-
Step 2 Enable	Step 2 enable/disable	Disable/Enable	Disable
Step 2 Direction	Step 2 search direction	+/-	-
Step 3 Enable	Step 3 enable/disable	Disable/Enable	Disable
Step 3 Direction	Step 3 search direction	+/-	+
Step 4 Enable	Step 4 enable/disable	Disable/Enable	Disable
Step 4 Direction	Step 4 search direction	+/-	+
Position Clear	Position counter clear	Disable/Enable	Enable
Using Limit Signal	Using over limit signal	Disable/Enable	Disable
DCC Enable	Deviation counter clear enable	Disable/Enable	Disable
DCC Level	Deviation counter clear level	0 / 1	0
DCC Width (μ sec)	Deviation counter clear pulse width select	10, 20, 100, 200, 1000, 2000, 10000, 20000	10

6.4 Program Edit Screen

Program edit screen is to display and edit the driving programs of X and Y axes. Programs are registered in 0~63 of the register.

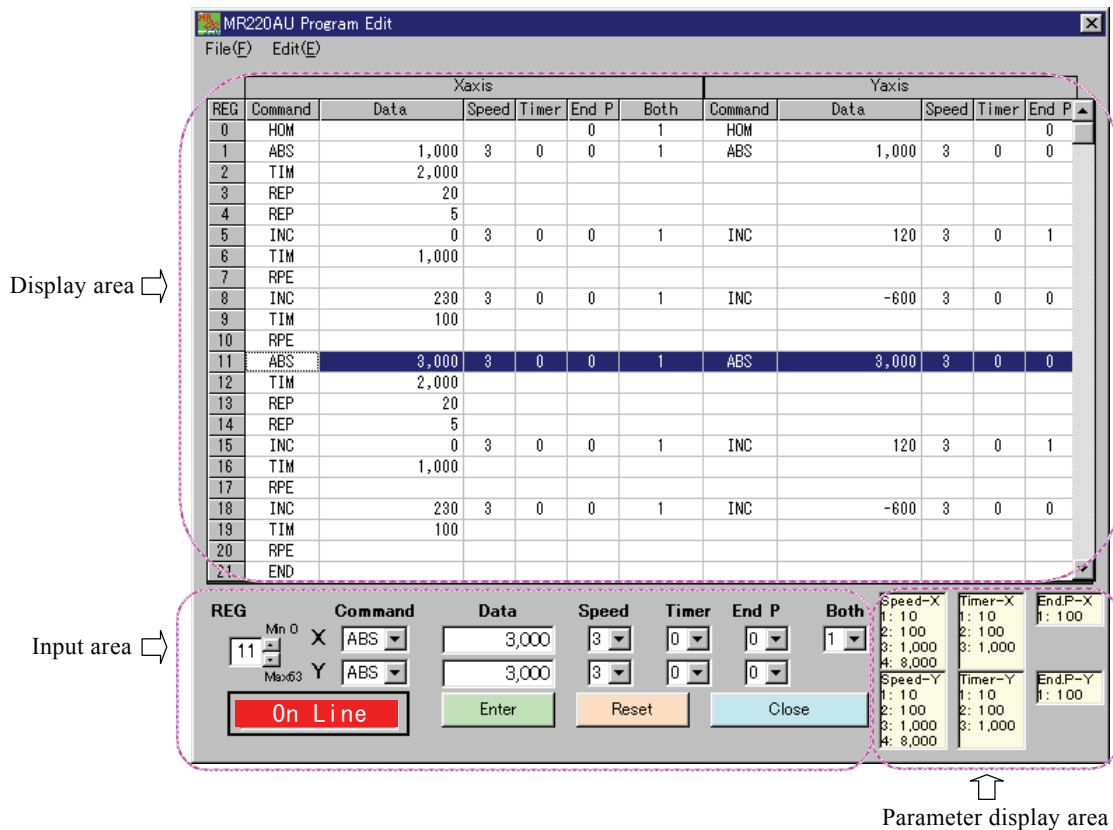

Program edit screen consists of three areas: program display area in upper part, program input area in lower left part and parameter display area in lower right part. The user can input and edit a program in the input area. If some register is clicked and selected in the display area, the values of the selected line is reflected in the input area.

■ Program Input and Edit Method

Concerning the displayed register, input each item as shown below. Click Enter button, and the input data is written and the register number is incremented by one. When online mode, the data is automatically downloaded to the motor control unit.

Input Item	Command	Contents
Command	Select command by click ▼.	
	ABS (Absolute position move)	OUT (Output port ON/OFF) IJP (Input condition jump)
	INC (Relative position move)	OTP (Output port ON Pulse) JMP (Jump)
	HOM (Home search)	REP (Repetition start) TIM (Timer)
Data	NOP (No operation)	RPE (Repetition end) END (Program end)
	ABS	Absolute position
	INC	Relative position
	OUT	Output port number – 0 (OFF)/ 1 (ON)
	OTP	Output port number – ON time (0 ~ 65,535msec)
	IJP	Input port number – register number to jump
	JMP	Register number to jump
	REP	Repetition numbers (1 ~ 255)
	TIM	Waiting time (0 ~ 65,535msec)
Speed	ABS, INC	Select drive speed 1~4.
	Other Commands	No required.
Timer	ABS, INC	Select post timer 1~3. If not needed, select 0.
	Other Commands	No required.

End P	ABS, INC, HOM	Select 1 to output end pulse and select 0 not to output end pulse after the completion of the command. Note: When selecting 1, End Pulse must be enabled in mode setting.
	Other Commands	No required.
Both	X-Axis ABS, INC, HOM	When the user drives the same command of Y axis simultaneously, select 1.
	Other Commands	No required.

See chapter 4.1 and 4.2 for more details on each command and I/O port numbers.

Reset: If Reset button is pressed before Enter button, input data is reset and previous data is displayed.

[Note] Be sure to press Enter button after input, or the data is not written.

■ File Menu

File (F) menus in the upper left corner of the screen can save and open driving programs to/from disc. The functions of file menus are same as main screen, so please refer to Main Screen.

■ Edit Menu

Edit (E) menus in the upper left corner of the screen are shown as follows. The user can cut, copy and paste a selection in the display area.

Item	Function	Contents
Cut	Clear a selection	Copies a selection in the display area to clip board and clears the selection. When online mode, changed program data of the register is written to the motor control unit.
Copy	Copy a selection	Copies a selection in the display area to clip board.
Paste	Paste	Pastes from clip board to a selection in the display area. When online mode, changed program data of the register is written to the motor control unit.
Delete	Delete lines	Selected register in the display area is deleted by the axis or the line. Following lines are moved up. When online mode, the program data in lines under the deleted line is written to the motor control unit.
Insert	Insert lines	Blank lines, the number of lines currently selected, are inserted onto a selection in the display area. If lines are over 63 after insertion, the lines over 63 are deleted. When online mode, the program data in lines under the inserted line is written to the motor control unit.

6.5 Input/Output Screen

Input/Output screen displays the current status of an input signal during driving. In addition, output signal can be manually set. This screen works only when in online mode.

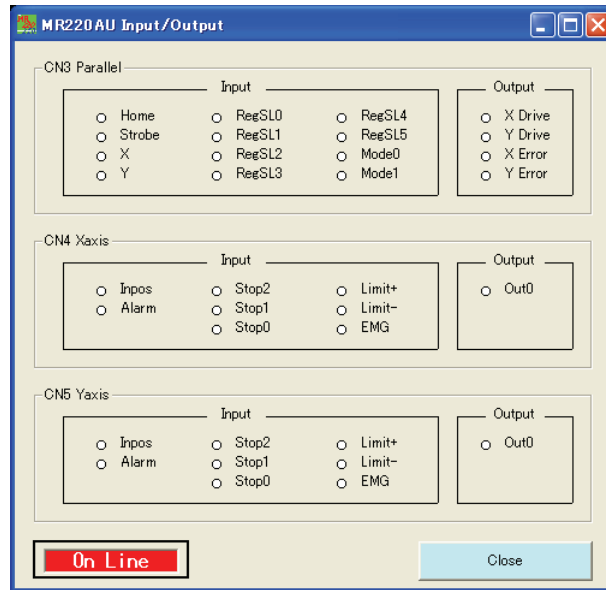

Input signal status of each axis in CN4, 5 turns on a light when the signal is active. For instance, if Limit Active Level is low in mode setting, limit signal (nLMT+/-) turns on a light when the signal is short-circuited with GEX. The input signal of CN3 parallel I/F turns on a light when the input signal is short-circuited with GEX. The output signal turns on a light when the output signal is ON (output transistor is ON). The user can alter ON/OFF by double-click on an output signal name.

6.6 Error List

Errors displayed at the bottom of main screen are as follows:

Code	Error Message	Contents
208	SOFTWARE LIMIT + ERROR	Software limit + occurs.
209	SOFTWARE LIMIT - ERROR	Software limit - occurs.
210	HARDWARE LIMIT + ERROR	nLMT+ signal is active.
211	HARDWARE LIMIT - ERROR	nLMT- signal is active.
212	ALARM ERROR	nALARM signal is active in Enable.
213	EMG ERROR	EMG is low level (GEX short-circuited)
214	PROGRAM ERROR	Program error
215	HOME ERROR	Home search error of the motor control unit
401	Break signal was received.	Break signal was received.
402	Frame error	Frame error
403	Port Overrun error	Port overrun
404	Recive buffer Overflow	Receive buffer overflow
405	Parity error	Parity error
406	Send buffer Full	Send buffer is full.
407	Device control block of Port was received.	Unexpected error that device control block (DCB) of port was received.
408	There is no response.	Command cannot be received.
501	X Axis is already driving now.	Another button to drive X axis is pressed during driving of X axis.
502	Y Axis is already driving now.	Another button to drive Y axis is pressed during driving of Y axis.
503	Please select Axis.	Each button of Home Search or Index/Program is pressed when an axis is not selected in main screen.
504	Please input number from 0 to 63 for REG.	The number other than 0~63 is input in register number.
505	Please input number.	Other than number is input.
506	Please input number within the limits.	The number beyond the input range is input.

When an error occurs, online mode may change to offline mode occasionally. In this case, offline is caused by a communication fault. Try out connections like File (F) > Upload > Parameter > X-Axis, it may returns to online.

7. Remote Box Operations

Remote box (MR200RB) is the tool to write driving mode, parameters and programs to MR210AU/220AU without PC. In addition, program execution, home search and jog feed can be performed.

Connect the cable (1.5m, included) to RS232C connector (CN2) of the motor control unit and power on the motor control unit, the user can operate the remote box.

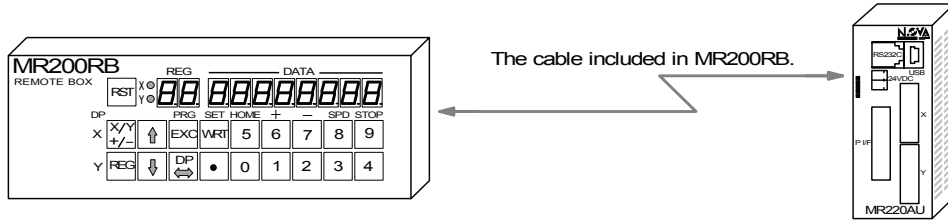

Remote box mainly performs two operations as shown below, data edit and drive operation. Register number is displayed in REG when used in data edit and **dp** (drive operation) is displayed when used in drive operation. When power is on, drive operation is selected (dp display). Data edit and drive operation can be switched by DP key.

	Operation	REG Display
Data Edit	<ul style="list-style-type: none"> Driving mode, Parameters and Programs writing One command execution 	Register Number
Drive Operation	<ul style="list-style-type: none"> Current Position Display Jog Feed Home Search Program Execution 	dp

Operation panel of the remote box is as follows:

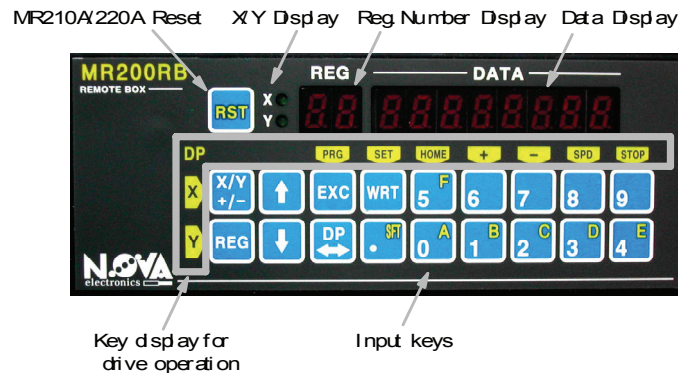

MR210AU/220AU Reset
Resets the MR210AU/220AU.

X/Y Display
Displays the currently selected axis.

Register Number Display
The number of the currently selected register is displayed when used in data editor **dp** is displayed when used in drive operation.

Data Display
The data of each register is displayed when used in data edit or the current position of the selected axis is displayed when used in drive operation.

Input Keys

- X/Y: Switches the axis. When inputting numbers, it is used to switch signs and when inputting modes, it is used to switch values.
- REG: Uses to input the register number which the user wants to display. When data is written, the user can abort data writing by pressing this key, and the value returns to the previous one.
- ↑ ↓: Increases and decreases the displayed register number.
- EXC: Executes the displayed command. However, only ABS, INC, OUT, OTP and HOM1~4 commands are available.
- DP: Switches data edit and drive operation.
- WRT: Uses to write (register) a value when used in data edit.

Key Display for Drive Operation

Displays the function of keys for drive operation on the left and top of input keys in yellow. The upper row of keys is for X axis and the lower is for Y axis.

7.1 Data Edit Operation

Data edit can write and change driving mode, parameters and programs. When data edit operation is performed, the register number from 00 to 95 is displayed in REG. When dp is displayed in REG, it is drive operation, so press DP key to switch to data edit.

7.1.1 Register Select

Each axis has registers from 00 to 95 and there are two ways to display the desired register number as follows:

- Press REG key and input the register number in two digits. Ex. REG 0 4 ----- REG4
- Press ↑ ↓ keys to increase and decrease the register number.

If the ↑ ↓ key is shortly pressed, the number is incremented or decremented by one, and pressed the keys longer, the number is incremented or decremented continuously. However, when ABS, INC commands are registered in the register, the position data is first displayed and the mode data is displayed by pressing the key shortly, then next register is displayed by each pressing the key.

7.1.2 Register Configuration











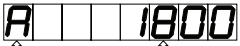
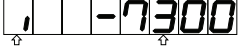

Register configuration displayed by the remote box is as follows:

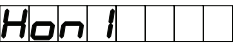
REG Number	Contents	Data Type		Remark
		Number Data	Mode Data	
00 : 63	Driving programs	●	●	
64~70	Blank			
71	Driving mode 1		●	
72	Driving mode 2		●	
73	Axis input signal filter			cannot be changed
74	Speed multiplier (1~500)	●		
75	—			
76	Acceleration rata (1~8000)	●		
77	Deceleration rate (1~8000)	●		
78	Start speed (1~8000)	●		
79	Drive speed 1 (1~8000)	●		
80	Drive speed 2 (1~8000)	●		
81	Drive speed 3 (1~8000)	●		
82	Drive speed 4 (1~8000)	●		
83	Home search high-speed (1~8000)	●		
84	Home search low-speed (1~8000)	●		
85	Home search mode 1		●	
86	Home search mode 2		●	
87	Home search offset (-8388608~+8388607)	●		
88	Software limit+ (-8388608~+8388607)	●		
89	Software limit- (-8388608~+8388607)	●		
90	Post timer 1 (1~65535)	●		
91	Post timer 2 (1~65535)	●		
92	Post timer 3 (1~65535)	●		
93	Driving end pulse width (1~65535)	●		
94	Pulse scale numerator	●		cannot be changed
95	Pulse scale denominator	●		cannot be changed

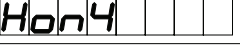
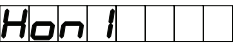
[Note] Remote box has no scaling function for driving pulse. Position data of REG00~63 and parameters of REG87, 88 and 89 are all the pulse values. The parameters of REG94, 95 cannot be changed.

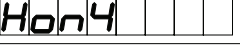
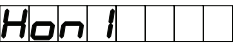
7.1.3 Writing of Driving Programs

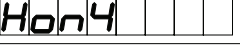
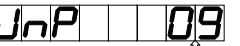
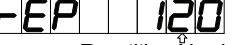
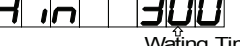
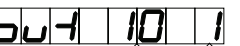
Driving programs are registered in the register number 00~63. Each command display and input procedure is described below. See chapter 4 for each command detail.

Command	Display	Input Procedure																						
		Input Operation	Description																					
ABS INC	<p>ABS  ABS Display Absolute Position</p> <p>INC  INC Display Relative Position</p> <p>Mode  ABS/INC 0:INC, 1:ABS Drive Speed 1, 2, 3, 4 Post Timer 0, 1, 2, 3 End P 0:Disable, 1:Enable Both 0:Disable, 1:Enable</p> <p>In mode display, decimal point lights in all the digits.</p>	1	Press WRT.	Status becomes command input and ABS blinks.																				
		2	Select command by ↑ ↓ keys.	ABS:  INC: 																				
		3	Press WRT.	Command is determined.																				
		4	Input the position data (pulse value) by 10 keys.	Negative value can be input by +/- keys.																				
		5	Press WRT.	The position data is determined and mode is displayed.																				
		6	Set each mode by +/- and . keys.	+/- key switches the blinking value. . key shifts the selected item.																				
		7	Press WRT.	Position data flushes twice to inform registration completion.																				
HOM	Select any of HOM1~4 commands depends on disable/enable of EndP (End Pulse) or Both (Y axis simultaneously).	1	Press WRT.	Status becomes command input and ABS blinks.																				
	<table border="1" data-bbox="343 1142 805 1388"> <thead> <tr> <th></th> <th>Display</th> <th>End P</th> <th>Both</th> </tr> </thead> <tbody> <tr> <td>HOM1</td> <td></td> <td>Disable</td> <td>Disable</td> </tr> <tr> <td>HOM2</td> <td></td> <td>Enable</td> <td>Disable</td> </tr> <tr> <td>HOM3</td> <td></td> <td>Disable</td> <td>Enable</td> </tr> <tr> <td>HOM4</td> <td></td> <td>Enable</td> <td>Enable</td> </tr> </tbody> </table>		Display	End P	Both	HOM1		Disable	Disable	HOM2		Enable	Disable	HOM3		Disable	Enable	HOM4		Enable	Enable	2	Select command by ↑ ↓ keys.	Select any of HOM1 ~ HOM4.
		Display	End P	Both																				
	HOM1		Disable	Disable																				
HOM2		Enable	Disable																					
HOM3		Disable	Enable																					
HOM4		Enable	Enable																					
		3	Press WRT.	Display flushes twice to inform registration completion.																				
				Note: When Y axis, HOM3, 4 cannot be selected.																				
JMP REP TIM	<p>JMP  REG to Jump</p> <p>REP  Repetition Numbers</p> <p>TIM  Waiting Time</p>	1	Press WRT.	Status becomes command input and ABS blinks.																				
		2	Select command by ↑ ↓ keys.																					
		3	Press WRT.	Command is determined.																				
		4	Input values by 10 keys.	Input numbers are displayed from the right side of DATA.																				
		5	Press WRT.	Display flushes twice to inform registration completion.																				
OUT IJP OTP	<p>OUT  Output Port 0(OFF)/1(ON)</p> <p>IJP  Input Port REG to Jump</p> <p>OTP  Output Port Pulse Width</p>	1	Press WRT.	Status becomes command input and ABS blinks.																				
		2	Select command by ↑ ↓ keys.																					
		3	Press WRT.	Command is determined.																				
		4	Input the first (left side) digit by 10 keys.																					

	<p>[Note] When using the remote box, set the pulse width of OTP command within the range from 0 to 99 (msec). If the number beyond the range is already registered on PC, the pulse width is not displayed.</p>	5	Press · key.	Waits for input of the second (right side) digit.
		6	Input the second (right side) digit by 10 keys.	
		7	Press WRT.	Display flushes twice to inform registration completion.
RPE NOP END	RPE <input type="text" value="rPE"/> NOP <input type="text" value="noP"/> END <input type="text" value="End"/>	1	Press WRT.	Status becomes command input and ABS blinks.
		2	Select command by ↑ ↓ keys.	
		3	Press WRT.	Display flushes twice to inform registration completion.

When the user wants to abort the input, press REG key, and the data returns to the one before input.

[Note] Position data must be input as pulse value. Remote box has no scaling function for driving pulse.

7.1.4 Writing of Driving Mode and Parameters

Driving mode and parameters are registered in the register number 71~95. Display and input procedure is described below. See chapter 3 for each mode and parameter.

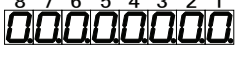
Parameter/ Mode	REG	Display	Input Procedure			
			Input Operation		Description	
Parameter	74	Each parameter is displayed in DATA.	1	Press WRT.	Status becomes input.	
	:		84	2	Input values by 10 keys.	
	:			3	Press WRT.	Display flushes twice to inform registration completion.
	87		:	95		
Mode	71	<p style="text-align: center;">DATA Display</p> <p style="text-align: center;">8 7 6 5 4 3 2 1</p>  <p>Please refer to "■ Mode Display" regarding items displayed in the 1~8 digits of DATA display in each register.</p>	1	Press WRT.	Status becomes input and the mode of DATA display 1 is selected.	
	72		2	Set each mode by +/- key and *key.	+/- key switches the selected value. *key shifts the selected item.	
	85		3	Press WRT.	Display flushes twice to inform registration completion.	
	86					

■ Mode Display

REG71 Driving Mode 1 ----- Display Contents of each digit in DATA

REG DATA
71 00000000

- 1 Limit Stop 0: Instant Stop, 1: Deceleration Stop
- 2 Limit Signal Level 0: GEX Short-circuited, 1: Open
- 3 Inposition 0: Disable, 1: Enable
- 4 Inposition Signal Level 0: GEX Short-circuited, 1: Open
- 5 Alarm 0: Disable, 1: Enable
- 6 Alarm Signal Level 0: GEX Short-circuited, 1: Open

REG72 Driving Mode 2 ----- Display Contents of each digit in DATA

REG DATA
72 00 100000

- 1 Near Home Signal(STOP0) Level 0: GEX Short-circuited, 1: Open
- 2 Home Signal(STOP1) Level 0: GEX Short-circuited, 1: Open
- 3 Z-phase Signal(STOP2) Level 0: GEX Short-circuited, 1: Open
- 4 Driving End Pulse 0: Disable, 1: Enable
- 5 Deceleration Rate 0: Acceleration Value, 1: Deceleration Value
- 6 Software Limit 0: Enable, 1: Disable (Note: Level is opposite.)
- 7 Power On Home Search Start 0: Disable, 1: Enable
- 8 Power On Program Start 0: Disable, 1: Enable

REG85 Home Search 1 ----- Display Contents of each digit in DATA

REG DATA
85 0000 10 10

- 1 Step 1 Enable 0: Disable, 1: Enable
- 2 Step 1 Direction 0:+, 1:-
- 3 Step 2 Enable 0: Disable, 1: Enable
- 4 Step 2 Direction 0:+, 1:-
- 5 Step 3 Enable 0: Disable, 1: Enable
- 6 Step 3 Direction 0:+, 1:-
- 7 Step 4 Enable 0: Disable, 1: Enable
- 8 Step 4 Direction 0:+, 1:-

REG86 Home Search 2 ----- Display Contents of each digit in DATA

REG DATA
86 00000001

- 1 Position Counter Clear 0: Disable, 1: Enable
- 2 - (Fixed to 0.)
- 3 Using Limit Signal 0: Disable, 1: Enable
- 4 DCC 0: Disable, 1: Enable
- 5 DCC Level 0:ON Pulse, 1:OFF Pulse

DATA Digits			DCC Pulse Width (μ sec)
8	7	6	
0	0	0	10
0	0	1	20
0	1	0	100
0	1	1	200
1	0	0	1000
1	0	1	2000
1	1	0	10000
1	1	1	20000

7.1.5 One Command Execution

Only one command of the register commands, which is displayed in data edit, is performed. Select an axis by X/Y key and press EXC key, the command of the currently displayed register is executed; however, the executable commands are only ABS, INC, OUT, OTP and HOM1~4. When other command is registered, no operation is performed by EXC key. Although this function usually performs for only one axis, if Both is set in X axis, ABS, INC or HOM1~4 command is simultaneously performed for both X and Y axes by EXC key of X axis.

7.2 Drive Operation

Drive operation performs jog feed, home search and program execution. When dp is displayed in REG, it is drive operation. When the register number is displayed, press DP key to switch to drive operation.

In drive operation, the current position of the selected axis is displayed in DATA.

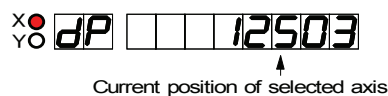

As shown on the left side of input keys in yellow, the upper row of keys is for X axis and the lower is for Y axis. Each key function is shown on the top of input keys in yellow. However, DP key has only the function to switch data edit and drive operation.

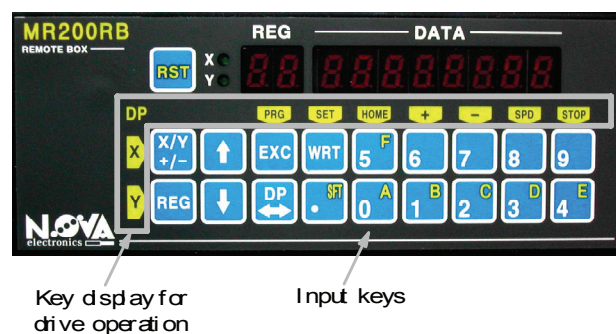

7.2.1 Home Search

Keys for home search are as follows:

Display in Yellow	Input Key	Operation
X HOME	5	X axis Home Search Execution
Y HOME	0	Y axis Home Search Execution

It is possible to operate both X and Y-axes simultaneously. If the user wants to abort home search, press STOP key of each axis.

[Note] Driving mode, parameters and home search mode must be configured before execution of home search. Or home search can fail to perform.

7.2.2 Jog Feed

Jog feed by the remote box operates to drive in the specified direction while pressing the key. In addition, drive speed can be switched.

Display in Yellow	Input Key	Operation
X +	6	X Axis Jog Feed in the +direction
X -	7	X Axis Jog Feed in the -direction
Y +	1	Y Axis Jog Feed in the +direction
Y -	2	Y Axis Jog Feed in the -direction
X SPD	8	Drive speed switches 1, 2, 3, 4 by each pressing the key. Drive speed 1~4 is the values set in REG79~82.
Y SPD	3	Drive speed 0 outputs single pulse. Press the key, the current registered speed is displayed first, then press again, the speed is switched.

7.2.3 Program Execution

Registered driving programs are executed from the specified register number.

Program execution can perform for only X axis, only Y axis and for both X and Y axes simultaneously. While driving X axis, Y axis cannot be executed and while driving Y axis, X axis cannot be executed.

Operations for program execution are as follows:

	Input Operation	Description
1	Press EXC key.	Program execution starts.
2	Press X/Y key to specify the axis.	A selection indicator switches from X axis → Y axis → X/Y axes by each pressing X/Y key.
3	Press 10 keys to input the register number.	Input the register number 0~63 to start execution by 10 keys.
4	Press EXC key.	Program execution starts.

Example: Execute X axis from the register number 10.

EXC → [X/Y] → 1 → 0 → EXC

If the user wants to abort program execution, press STOP key (X: 9, Y: 4).

While running, the current position of X axis is displayed; however, when X axis ends and Y axis is running, the current position of Y axis is displayed.

7.2.4 Current Position Writing

The current position writing (teaching) functions to register the current position as ABS command in the register. ABS command is written to the register number which is displayed in data edit before drive operation (dp display). Therefore, it is necessary for current position writing to display the register which the user wants to register in data edit in advance.

Operations for current position writing are as follows:

	Input Operation	Description
1	Display the register which the user wants to register the current position in data edit.	The current position is written to the displayed register.
2	Press DP key to switch drive operation.	
3	Drive the axis to the position to be written by +, - key of each axis.	Drive speed can be switched.
4	Press X/Y key to select the axis.	The light of the selected axis turns on. Current position writing performs each axis, and cannot perform X and Y axes simultaneously.
5	Press WRT key.	The current position data blinks to confirm the writing, if DP key is pressed at this time, the writing is canceled.
6	Press WRT key again.	It returns to data edit (register display) and data flushes twice to inform the current position is written as ABS command. When the user tries to write another axis, repeat #2~6.

Mode Change

Current position writing is written as ABS command, at this time, the mode is automatically set to ABS, Drive speed: 1, Post timer: 0, End P: 0 and Both: 0. Please change the mode when needed.

Press ↑ key, then press WRT key while the mode is displayed, the user can change each bit of the currently configured mode.

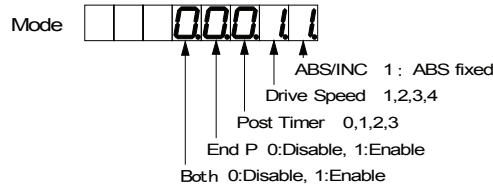

8. Input/Output Signal Connection

Each connector position and pin number of MR220AU are shown below. **Please be careful not to connect a wrong pin number. Reverse connection of power connector (CN1) or supplying any voltage/current other than specified to each signal may cause the destruction of the internal circuit.**

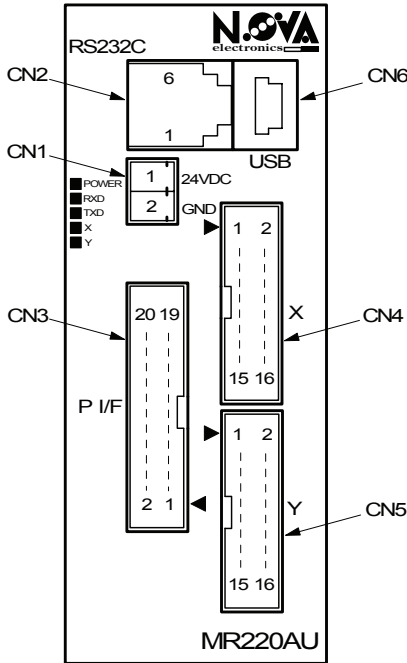

Connector	Connector Type	Other Side Connector Type
CN1	Power Connector	MC1.5/2-G-3.5(PHOENIX) or equivalent
CN2	RS-232C Connector	6P Modular Connector
CN3	Parallel I/F Connector	20P MIL Standard 2.54mm Ribbon Connector
CN4	X axis I/O Connector	16P MIL Standard 2.54mm Ribbon Connector
CN5	Y axis I/O Connector	16P MIL Standard 2.54mm Ribbon Connector
CN6	USB Connector	Mini USB B Connector

Fig.8.1 MR220AU Front Panel

MR210AU does not have CN5.

8.1 CN1 Power Connector

Connect the DC24V power supply to the terminal in accordance with the polarity.



Pin Number	Signal
1	+24V
2	GEX (0V)

8.2 CN2 RS232C Serial I/F Connector

RS232C serial communication connector. Connect the accessory cable to the port of PC or the remote box, and the user can perform program edit or manual operation through PC or the remote box (MR200RB).

Pin Number	Signal	I/O	Contents
1	TXD	Output	Send data
2	RXD	Input	Received data
3	GND		Signal ground
4			nothing is connected
5			nothing is connected
6			nothing is connected



For reference, the internal wiring diagram of the accessory RS232C cable is as follows:

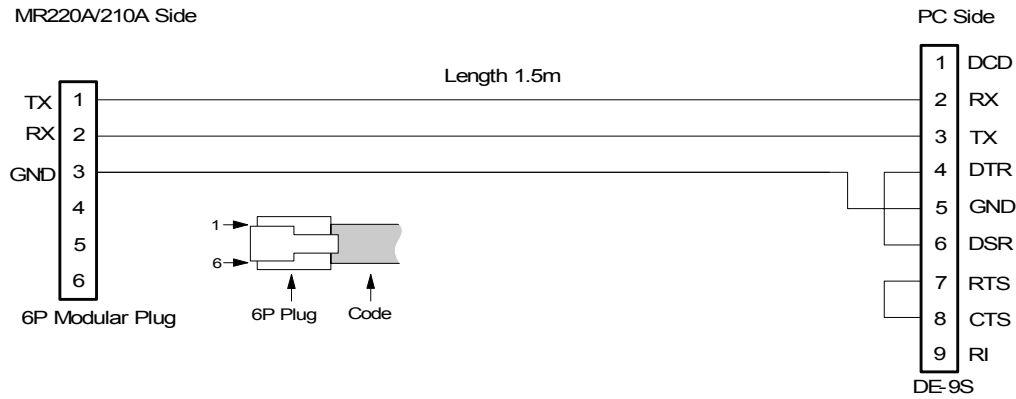

Fig.8.2 RS232C Serial Communication Cable (included)

8.3 CN3 Parallel I/F Connector

Connect this parallel interface to a PLC or mechanical contacts, the user can drive the program registered in MR220AU/210AU or index data. See chapter 5 for more details on driving. In this manual, Turning ON/OFF is used for input/output signals. Turning an input signal ON means the signal is short-circuited with GEX by a mechanical contact or open collector output. And turning an output signal ON means the output transistor of an open collector turns ON.

Pin No.	Signal	I/O	Contents	Circuit	Description
1	RESET	Input	Reset	A1	1
2	HOME	Input	Home search start strobe	A1	2
3	STROBE	Input	Drive start strobe	A1	3
4	X /SCANY+	Input	X axis designation /Scan2 Y+	A1	4
5	Y /SCANY-	Input	Y axis designation /Scan2 Y-	A1	4
6	REGSL0/RUN+ /SCANX+	Input	Register designation 0 /Run+ /Scan2 X+	A1	5
7	REGSL1/RUN- /SCANX-	Input	Register designation 1 /Run- /Scan2 X-	A1	5
8	REGSL2/SPD0	Input	Register designation 2 /Drive speed 0	A1	5
9	REGSL3/SPD1	Input	Register designation 3 / Drive speed 1	A1	5
10	REGSL4 /SCAN	Input	Register designation 4 /Scan	A1	5
11	REGSL5/STOP	Input	Register designation 5 /Drive stop	A1	5
12	MODE0	Input	Driving mode designation 0	A1	6
13	MODE1	Input	Driving mode designation 1	A1	6
14	XDRIVE/END	Output	X axis driving /Driving end pulse	B1	7
15	YDRIVE/END	Output	Y axis driving /Driving end pulse	B1	7
16	XERROR	Output	X axis error	B1	8
17	YERROR	Output	Y axis error	B1	8
18	GEX		Ground		
19	GEX		Ground		
20	VEX		Power output (DC24V, under 100mA)		

Input Signal Circuit A1 (CN3 control input signal)

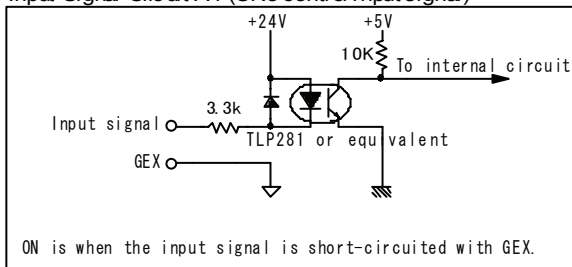

Output Signal Circuit B1 (CN3 control output signal)

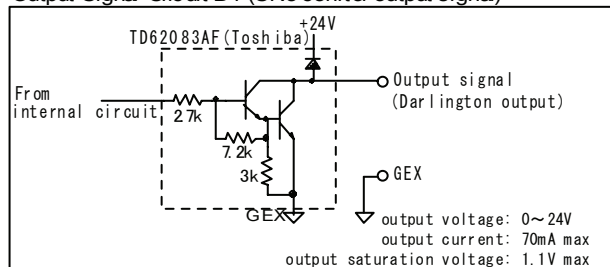

Description 1 : RESET Pin1 Input Reset

All the internal operations are reset. Turns ON for 20msec or more. It can also be used as an emergency stop signal.

Description 2 : Home Pin 2 Input Home search start strobe

Turning on starts home search. When both X (4) and Y (5) axes are ON, home search simultaneously starts for X and Y axes. When only one axis is ON, home search starts for the one axis. This strobe signal must be ON for more than 10msec, or return back to OFF after the confirmation of nDRIVE/END signal ON. However, if the user uses nDRIVE/END signal as driving end pulse, HOME signal must be ON for more than 10msec. See chapter 5.1.

[Note] When using scan driving 2, do not turn this signal ON.

Description 3 : STROBE Pin 3 Input Drive Start Strobe

Strobe signal in index mode and program mode. Select a register number and X/Y axis then turn this signal ON, and driving starts. This strobe signal must be ON for more than 10msec, or return back to OFF after the confirmation of nDRIVE/END signal ON. However, if the user uses nDRIVE/END signal as driving end pulse, this STROBE signal must be ON for more than 10msec. See chapter 5.2, 5.5.

Description 4 : X/SCANY+ Pin 4 Input X axis designation / Scan Drive 2: Y+

X/SCANY- Pin 5 Input X axis designation / Scan Drive 2: Y-

Specifies an axis when in index mode or program mode. Turning the specified axis ON selects the axis. This axis designation signal must be ON before STROBE signal turns ON.

When in scan driving 2 mode, turning SCANY+ (4) ON outputs drive pulses in Y+ direction and turning SCANY- (5) outputs drive pulses in Y- direction. See chapter 5.3.

Description 5 : REGSL0/RUN+/SCANX+ Pin 6 Input Register designation 0 / Run+ /Scan Drive 2: X+

REGSL1/RUN-/SCANX- Pin 7 Input Register designation 1 / Run- /Scan Drive 2: X-

REGSL2/SPD0 Pin 8 Input Register designation 2 / Drive Speed 0

REGSL3/SPD1 Pin 9 Input Register designation 3 / Drive Speed 1

REGSL4 /SCAN Pin 10 Input Register designation 4 /Scan

REGSL5/STOP Pin 11 Input Register designation 5 / Drive Stop

Specifies a register number to be executed in index mode or program mode from REG00 to 63. REGSL0 is the lowest bit and REGSL5 is the highest bit. See chapter 5.2 for more details on how to specify.

RUN+ (6) and RUN- (7) are used in scan driving 1 (SCAN (10) = OFF) or continuous driving. Specify (4, 5) the axis to drive and turns RUN+ (6) ON, and drive pulses are output in + direction, or turn RUN- (7) ON, and drive pulses are output in - direction. Drive speed can be specified by SPD0, 1 (8, 9) for this time.

Drive Speed Designation

Drive Speed	SPD1(9)	SPD0(8)
Drive Speed 1	OFF	OFF
Drive Speed 2	OFF	ON
Drive Speed 3	ON	OFF
Drive Speed 4	ON	ON

[Note] If drive speed designation is changed during driving Drive Speed changes immediately. Drive Speed can be changed with Serial Communication Command during driving with Parallel Interface. So if Drive Speed is change with Parallel Interface and Serial Communication Command, the actual Driving Speed is different from the commanded one with Parallel Interface.

When using scan driving 2 (SCAN (10) = ON), turning SCANX+ (6) ON outputs drive pulses in X+ direction and turning SCANX- (7) ON outputs drive pulses in X - direction. See chapter 5.3.

STOP (11) drive stop signal is the function to stop driving by turning this signal ON with the axis designation. As shown in the table below, the operation differs depending on driving mode. To function STOP signal, turn the signal ON for more than 10msec.

Driving mode	Operation in STOP signal ON
Index driving	Aborts driving of ABS, INC commands while running. Note1
Scan driving 1, 2	not available
Continuous driving	Stops continuous driving.
Program driving	Stops the program. When drive command is running, it aborts the driving. Note1
Home search	Aborts home search.

[Note1] This STOP signal shares with the register designation signal (REGSL5). When the signal is ON for register designation before driving starts, turn STROBE signal OFF and turn REGSL5/STOP signal (11) OFF and again turn it ON, and driving will stop as shown in the diagram below. When driving stops, turn back STOP signal to OFF.

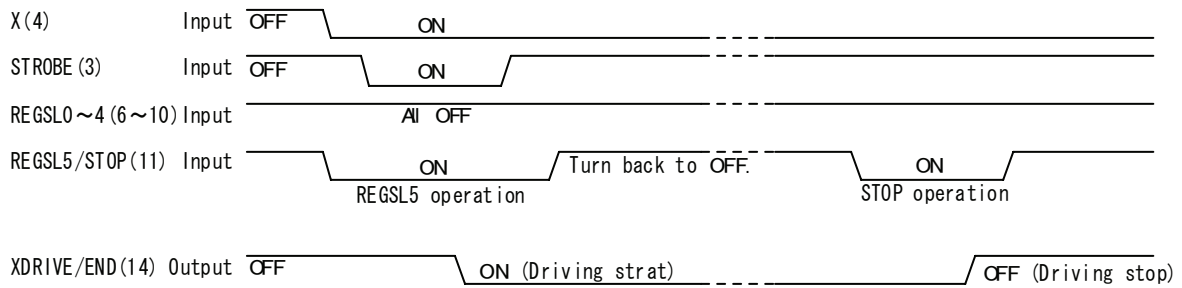

Fig.8.3 Example of the REG32 index drive and aborting the drive by STOP signal

Description 6 : MODE0 Pin12 Input Driving mode designation 0
 MODE1 Pin13 Input Driving mode designation 1

Specifies driving mode for parallel I/F.

MODE1(13)	MODE0(12)	Driving Mode	For reference
OFF	OFF	Index driving	Chapter 5.2
OFF	ON	Scan driving Scan driving 1: SCAN(10)=OFF Scan driving 2: SCAN(10)=ON	Chapter 5.3
ON	OFF	Continuous driving	Chapter 5.4
ON	ON	Program driving	Chapter 5.5

Description 7 : XDRIVE/END Pin14 Output X axis driving / Driving end pulse
 YDRIVE/END Pin15 Output Y axis driving / Driving end pulse

Basically this output signal turns ON when driving pulses are output. However, depending on driving mode for parallel I/F or mode setting registered in the motor control unit, it differs as follows:

DRIVE/END(14,15) Output Signal Operation

Parallel I/F Operation Mode	When Driving end pulse = Invalid in mode setting of the motor control unit.	When Driving end pulse = Valid in mode setting of the motor control unit.
Home Search	Turns ON while running home search and turns OFF after the end of driving.	Turns OFF while running home search and outputs driving end pulse after the end of driving.
Index Driving	Turns ON while outputting driving pulse and turns OFF after the end of driving.	Outputs driving end pulse after completion of the command execution which End Pulse is enabled.
Scan Driving	Turns ON while outputting driving pulse and turns OFF after the end of driving.	Turns OFF while driving and outputs driving end pulse after the end of driving.
Continuous Driving	Turns ON while outputting driving pulse and turns OFF after the end of driving.	Turns OFF while driving and outputs driving end pulse after the end of driving.
Program Driving	Turns ON while executing program and turns OFF after the end of program.	Outputs driving end pulse after completion of the command execution which End Pulse is enabled in the program.

Description 8 : XERROR Pin16 Output X axis error output
 YERROR Pin17 Output Y axis error output

Turns ON when error occurs in the control of each axis.

8.4 CN4, 5 Axis I/O Connector

CN4 is for X axis and CN5 is for Y axis of input/output signals. CN4 and CN5 are completely the same pin assignments. MR210AU does not have CN5.

“n” in the table indicates X in CN4 and Y in CN5.

Pin No.	Signal	I/O	Contents	Circuit	Description
1	nP+P	Output	Driving pulse positive output in the + direction	B2	9
2	nP+N	Output	Driving pulse negative output in the + direction	B2	9
3	nP-P	Output	Driving pulse positive output in the - direction	B2	9
4	nP-N	Output	Driving pulse negative output in the - direction	B2	9
5	nOUT0	Output	General output 0 / Deviation counter clear output	B1	10
6	nINPOS	Input	Servo positioning completion	A1	11
7	nALARM	Input	Servo alarm	A1	12
8	GEX		Ground		
9	nSTOP2	Input	Encoder Z-phase	A1	13
10	nSTOP1	Input	Home	A1	13
11	nSTOP0	Input	Near home	A1	13
12	nLMT+	Input	Limit in the + direction	A1	14
13	nLMT-	Input	Limit in the - direction	A1	14
14	EMG	Input	Emergency stop	A1	15
15	GEX		Ground		
16	VEX		Power output for a sensor (+24V)		16

Output Signal Circuit B1 (CN4, 5 General Output Signal)

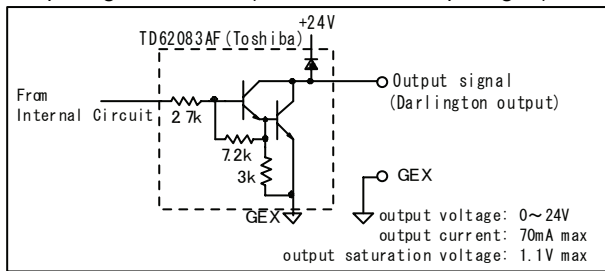

Output Signal Circuit B2 (CN4, 5 Driving Pulse Output)

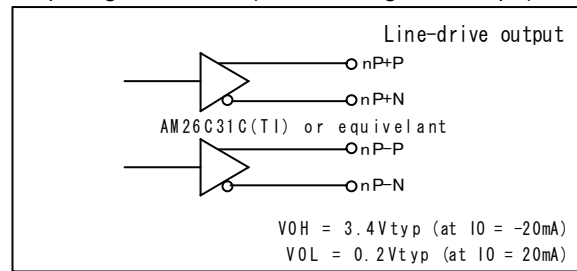

Input Signal Circuit A1 (CN4, 5 Input Signal)

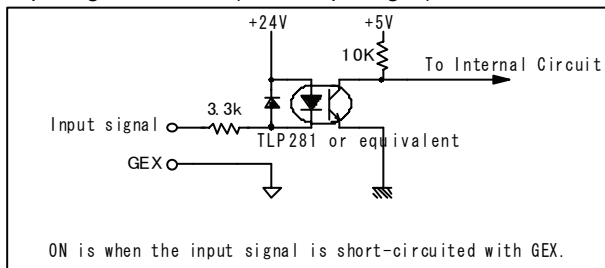

Description 9 :

nP+P	Pin1	Output	Driving pulse positive output in the + direction (n=X, Y)
nP+N	Pin2	Output	Driving pulse negative output in the + direction
nP-P	Pin3	Output	Driving pulse positive output in the - direction
nP-N	Pin4	Output	Driving pulse negative output in the - direction

Driving pulse output signal is output from differential line-drive (AM26C31 or equivalent) output.

nP+N is the reverse output of nP+P and nP-N is the reverse output of nP-P. At resetting, positive output (nP+P, nP-P) becomes low level and reverse output (nP+N, nP-N) becomes hi level. A connection example with a motor driver is shown as follows:

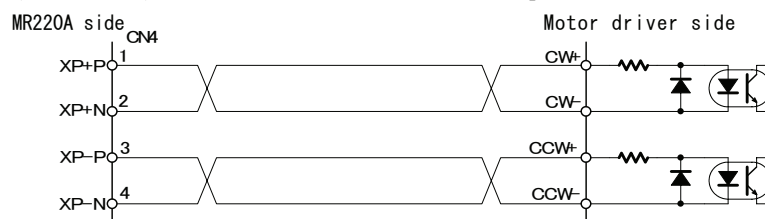

Description 10 : nOUT0 Pin5 Output General output 0 / Deviation counter clear output (n=X, Y)

This general output can be turned ON/OFF in the driving program. OUT command (output port ON/OFF) and OTP command (output port ON pulse) are prepared. When deviation counter clear operation is enabled (Enable) in home search mode setting, after completion of home search at step 3 (Z-phase search), the pulse output selected by deviation counter clear pulse width is output from nOUT0 signal in the level selected by deviation counter clear level.

Description 11 : nINPOS Pin6 Input Servo Positioning Completion (n=X, Y)

Input signal for a servo motor driver to connect Inposition output. When the user needs to wait for inposition, connect this. When using the signal, inposition for servo driver must be enabled in driving mode and the logical level must be set. For more details on operation, see chapter 3.1 “Servo Inposition Enable and Logical Level”.

Description 12 : nALARM Pin7 Input Servo Alarm (n=X, Y)

Input signal for a servo motor driver to connect Alarm output. When using the signal, servo alarm must be enabled in driving mode and the logical level must be set. For more details on operation, see chapter 3.1 “Servo Alarm Enable and Logical Level”.

Description 13 : nSTOP2 Pin9 Input Encoder Z-phase (n=X, Y)
nSTOP1 Pin10 Input Home
nSTOP0 Pin11 Input Near home

Input signal for home search. See chapter 3.3 “Home Search Mode Setting” for home search operation.

Description 14 : nLMT+ Pin12 Input Limit in the + direction (n=X, Y)
nLMT- Pin13 Input Limit in the - direction

nLMT+ input signal is the over limit signal in the + direction. When the signal is activated during output of drive pulse in the + direction, driving stops by decelerating or instantly. nLMT - input signal is the over limit signal in the - direction. When the signal is activated during output of drive pulse in the - direction, driving stops by decelerating or instantly. After stop, driving in the opposite direction can be performed even though these signals are active. Decelerating stop/Instant stop for limit stop or active logical level can be selected by mode setting. A connection example for over limit signals and home signal is shown as follows:

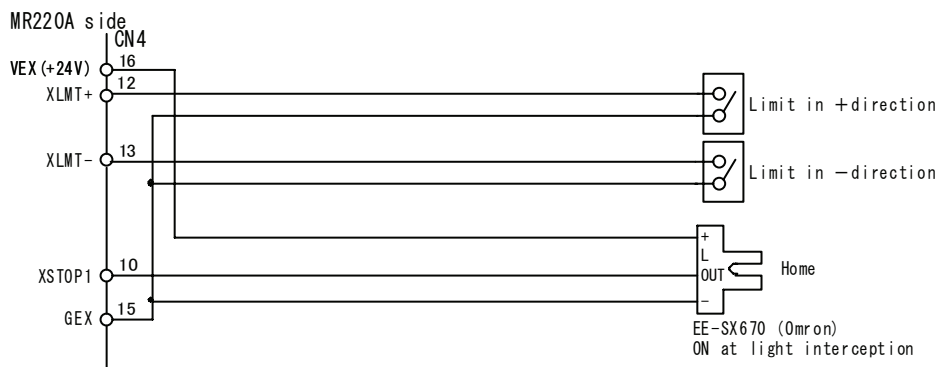

Description 15 : EMG Pin14 Input Emergency stop

Turn EMG input signal ON, and the user can stop all the driving axes instantly. This signal cannot select the logical level. Normally turn it OFF (open). To operate emergency stop, turn it ON (GEX short-circuited).

Description 16 : VEX Pin16 Power output for a sensor

+24V power output for a limit or home sensor to supply power. Be sure to use under 100mA. VEX power output is each output to CN3, 4, 5 connectors, which must be under total of 300mA.

9. Package Dimensions

Motor control unit

The following is the package dimension of MR210AU and MR220AU.

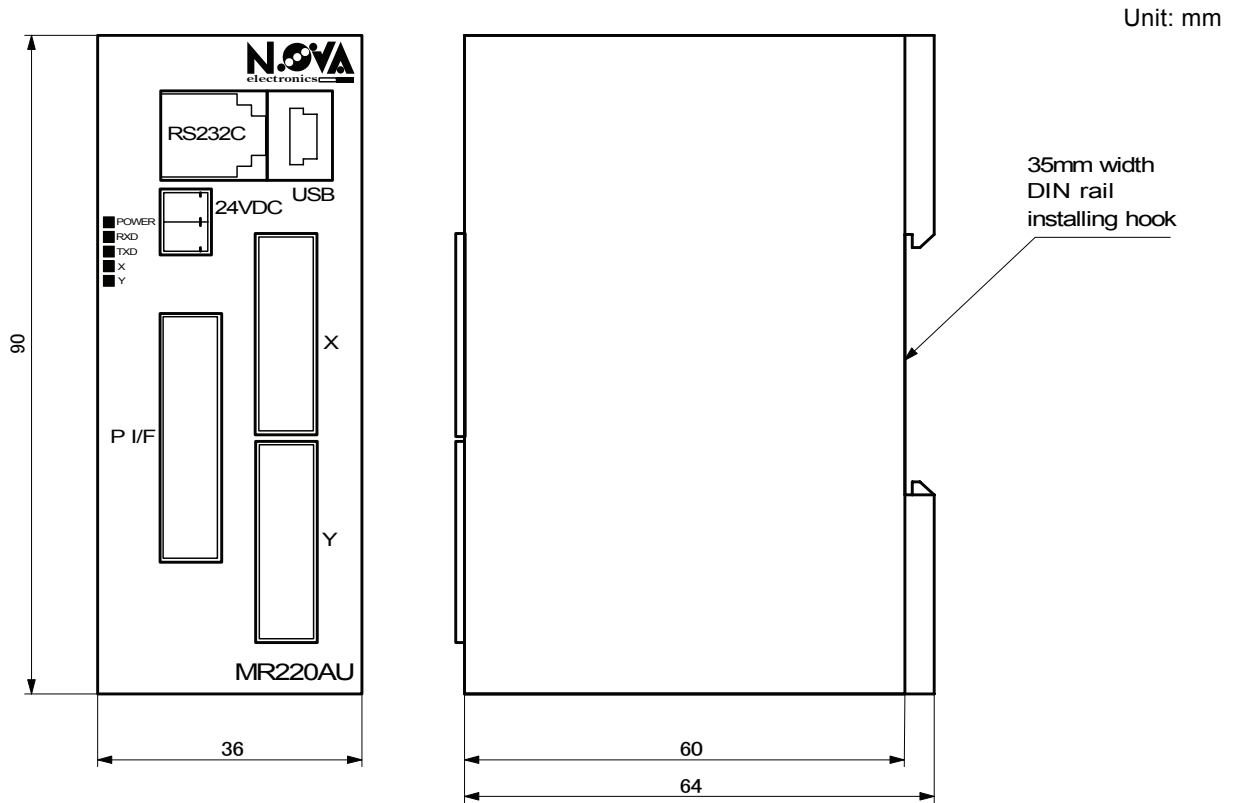

LED Indicator

Operations of LED indicator on the upper left corner are shown as follows:

LED Number	Name	Contents
LED1	POWER	Turns on a light during power-on.
LED2	RXD	Blinks during data receiving by serial communication (RS232C, USB).
LED3	TXD	Blinks during data sending by serial communication (RS232C, USB).
LED4	X	Turns on a light during driving of X axis and blinks at the error.
LED5	Y	Turns on a light during driving of Y axis and blinks at the error.

LED4, 5 turn on a light for 0.2 seconds for a indicator test at power-on or resetting.

Remote box MR200RB (Optional extra)

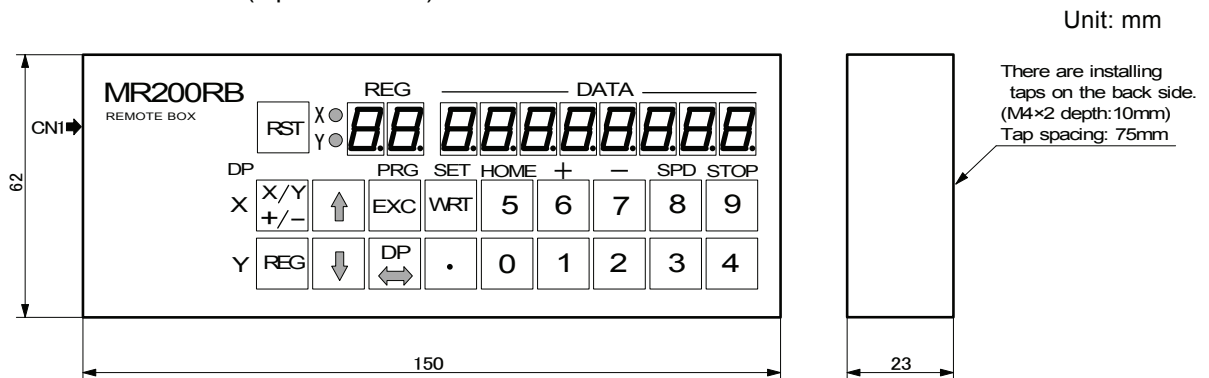

10. Specifications

Specifications	MR210AU	MR220AU									
Control Axis	1 axis	2 axes (independently programmable for each axis.)									
Controllable Motor	Stepper motor or pulse type servo motor										
Index Pulse Registration Numbers	64 for each axis										
Index Pulse Setting Range	-8388608~+8388607(Relative / Absolute value can be specified.) with Pulse Scaling Function										
Drive Speed Registration Numbers	4										
Drive Speed Setting Range	1pps~4Mpps (1~8000 × multiplier 1~500)										
Acceleration/Deceleration Curve	Constant speed, Linear Acceleration (Trapezoid)										
Driving Mode	<ul style="list-style-type: none"> • Home search • Scan driving • Continuous driving • Index driving • Program driving 										
Home Search Driving Mode	Automatically executes High-speed near home search (Step1) → Low-speed home search (Step2) → Low-speed Z-phase search (Step3) → High-speed offset drive (Step4). Search direction for each step and enable/disable can be specified.										
Program Function	<ul style="list-style-type: none"> • Memory media EEPROM • Steps 64 • Commands 12 commands <table border="1" style="margin-left: 40px;"> <tr> <td>Drive</td> <td>ABS INC HOM</td> <td>Absolute Position Move Relative Position Move Home Search</td> </tr> <tr> <td>I/O</td> <td>IJP OUT OTP</td> <td>Input Condition Jump Output Port ON/OFF Output Port ON Pulse</td> </tr> <tr> <td>Program Control</td> <td>JMP REP RPE END TIM NOP</td> <td>Jump Repetition Start Repetition End Program End Timer No Operation</td> </tr> </table> <ul style="list-style-type: none"> • Power On Program Start Function 		Drive	ABS INC HOM	Absolute Position Move Relative Position Move Home Search	I/O	IJP OUT OTP	Input Condition Jump Output Port ON/OFF Output Port ON Pulse	Program Control	JMP REP RPE END TIM NOP	Jump Repetition Start Repetition End Program End Timer No Operation
Drive	ABS INC HOM	Absolute Position Move Relative Position Move Home Search									
I/O	IJP OUT OTP	Input Condition Jump Output Port ON/OFF Output Port ON Pulse									
Program Control	JMP REP RPE END TIM NOP	Jump Repetition Start Repetition End Program End Timer No Operation									
Remote Box (Optional Extra) MR200RB	<ul style="list-style-type: none"> • Driving mode, Parameter and Program Writing • Driving operations (Jog, Program execution and Home search are available) 										
Control Interface	<ul style="list-style-type: none"> • Parallel I/F • RS-232C • USB (USB Standard 2.0 compliant) 	<ul style="list-style-type: none"> • Parallel I/F • RS-232C • USB (USB Standard 2.0 compliant) 									
General Output	1 point	2 points (1 point for each axis)									
Power Input	DC24V										
Consumption Current	Max. 0.25A when input/output signal is open.										
Temperature Range for Driving	0 ~ 45°C (No Condensation)										
Package Dimensions	90mm (Height) × 36mm (Width) × 64mm (Depth)										
Mass	96g	102g									
Accessory	CN1: MC1.5/2-ST-3.5(PHOENIX) or equivalent 1 CN3: 20P MIL standard 2.54mm connector 1 CN4: 16P MIL standard 2.54mm connector 1 RS-232C cable (1.5m) 1 USB cable (1.8m) 1	CN1: MC1.5/2-ST-3.5(PHOENIX) or equivalent 1 CN3: 20P MIL standard 2.54mm connector 1 CN4,5: 16P MIL standard 2.54mm connector 2 RS-232C cable (1.5m) 1 USB cable (1.8m) 1									
System Requirements for the Operating Program	OS: Windows 2000, XP, Vista, 7										