

mitsubishi

Mitsubishi Industrial Robot

CR750-D/CR751-D series and CRnD-700 series

INSTRUCTION MANUAL

CC-Link Interface

MELFA

BFP-A8701-E



Safety Precautions

Always read the following precautions and the separate "Safety Manual" before starting use of the robot to learn the required measures to be taken.



CAUTION

All teaching work must be carried out by an operator who has received special training. (This also applies to maintenance work with the power source turned ON.)
→Enforcement of safety training



CAUTION

For teaching work, prepare a work plan related to the methods and procedures of operating the robot, and to the measures to be taken when an error occurs or when restarting. Carry out work following this plan. (This also applies to maintenance work with the power source turned ON.)
→Preparation of work plan



WARNING

Prepare a device that allows operation to be stopped immediately during teaching work. (This also applies to maintenance work with the power source turned ON.)
→Setting of emergency stop switch



CAUTION

During teaching work, place a sign indicating that teaching work is in progress on the start switch, etc. (This also applies to maintenance work with the power source turned ON.)
→Indication of teaching work in progress



CAUTION

Provide a fence or enclosure during operation to prevent contact of the operator and robot.
→Installation of safety fence



CAUTION

Establish a set signaling method to the related operators for starting work, and follow this method.
→Signaling of operation start



CAUTION

As a principle turn the power OFF during maintenance work. Place a sign indicating that maintenance work is in progress on the start switch, etc.
→Indication of maintenance work in progress



CAUTION

Before starting work, inspect the robot, emergency stop switch and other related devices, etc., and confirm that there are no errors.
→Inspection before starting work

The points of the precautions given in the separate "Safety Manual" are given below. Refer to the actual "Safety Manual" for details.



Use the robot within the environment given in the specifications. Failure to do so could lead to a drop or reliability or faults. (Temperature, humidity, atmosphere, noise environment, etc.)



Transport the robot with the designated transportation posture. Transporting the robot in a non-designated posture could lead to personal injuries or faults from dropping.



Always use the robot installed on a secure table. Use in an instable posture could lead to positional deviation and vibration.



Wire the cable as far away from noise sources as possible. If placed near a noise source, positional deviation or malfunction could occur.



Do not apply excessive force on the connector or excessively bend the cable. Failure to observe this could lead to contact defects or wire breakage.



Make sure that the workpiece weight, including the hand, does not exceed the rated load or tolerable torque. Exceeding these values could lead to alarms or faults.



Securely install the hand and tool, and securely grasp the workpiece. Failure to observe this could lead to personal injuries or damage if the object comes off or flies off during operation.



Securely ground the robot and controller. Failure to observe this could lead to malfunctioning by noise or to electric shock accidents.



Indicate the operation state during robot operation. Failure to indicate the state could lead to operators approaching the robot or to incorrect operation.



When carrying out teaching work in the robot's movement range, always secure the priority right for the robot control. Failure to observe this could lead to personal injuries or damage if the robot is started with external commands.



Keep the jog speed as low as possible, and always watch the robot. Failure to do so could lead to interference with the workpiece or peripheral devices.



After editing the program, always confirm the operation with step operation before starting automatic operation. Failure to do so could lead to interference with peripheral devices because of programming mistakes, etc.



Make sure that if the safety fence entrance door is opened during automatic operation, the door is locked or that the robot will automatically stop. Failure to do so could lead to personal injuries.



Never carry out modifications based on personal judgments, non-designated maintenance parts. Failure to observe this could lead to faults or failures.



When the robot arm has to be moved by hand from an external area, do not place hands or fingers in the openings. Failure to observe this could lead to hands or fingers catching depending on the posture.



Do not stop the robot or apply emergency stop by turning the robot controller's main power OFF. If the robot controller main power is turned OFF during automatic operation, the robot accuracy could be adversely affected.

■ Revision History

Print date	Instruction manual No.	Revision content
2008-08-08	BFP-A8701	<ul style="list-style-type: none">• First print
2009-06-15	BFP-A8701-A	<ul style="list-style-type: none">• (Notes) were added in Introduction.• The robot system variables (M_In8,M_In16,M_Out8 and M_Out16) were added.
2011-12-27	BFP-A8701-B	<ul style="list-style-type: none">• Dip switch SW1 explanation was added.• CR751-D/CR750-D was added.
2012-03-13	BFP-A8701-C	<ul style="list-style-type: none">• The supplement about CR751-D/CR750-D was added. (Introduction, Table 3.1 1)
2012-04-11	BFP-A8701-D	<ul style="list-style-type: none">• The error in writing was corrected.
2012-11-27	BFP-A8701-E	<ul style="list-style-type: none">• Notes about transmission delay time were added to the communication cable.• The signal table was corrected. (Error in writing)

■ Introduction

Thank you very much for purchasing this product for Mitsubishi Electric Corporation's SD series industrial robots. CC-Link (Control & Communication Link) interface is an add-on option that is used in combination with CRnD-700 series controllers to add CC-Link field network functionality to robot controllers. Please make sure to read this document thoroughly and understand its information before start using the CC-Link interface.

Notes) In the software version P7th edition or later the updating cycle of the CC-Link interface was accelerated. (the CR750-D/CR751-D controller is also included.)

Although it changes with the structure of the user program, the standard of improvement in the speed is about one to 5 times. Therefore, in the existing robot system or the robot system constructed by the same specification as existing, the processing timing of the I/O signal will differ .

If the interlock of the I/O signal is not taken, the gap occurs to the timing of the signal and it may be impossible for the robot system to operate normally. The accelerated updating cycle can be returned to the origin by setting up "0" to the parameter: CCREFCYC. This is effective if the timing of the I/O signal has a bad influence on operation of the robot system.

Refer to " Table 3.2 3 List of Robot Parameters Used in CC-Link " for the details of the parameter.

- No part of this document may be reproduced without express permission of Mitsubishi Electric Corporation.
- Please note that the information in this manual is subject to change without notice in the future.
- Although this manual has been prepared to contain accurate information, please contact us if you find any errors or have questions.
- The product names used in this manual are trademarks or registered trademarks of respective owners.

CONTENTS

1. BEFORE USE	1
1.1. HOW TO USE THE INSTRUCTION MANUAL	1
1.2. GENERAL NAME AND ABBREVIATED NAME	2
2. FLOW OF OPERATIONS	3
2.1. FLOWCHART	3
3. FUNCTIONS AND SPECIFICATION OF THE CC-LINK INTERFACE	4
3.1. WHAT IS CC-LINK?	4
3.2. SPECIFICATION OF THE CC-LINK INTERFACE CARD	5
3.3. HARDWARE OF THE CC-LINK INTERFACE CARD	10
3.3.1. CARD OVERVIEW	10
3.3.2. DIP SWITCH	10
3.3.3. LED	12
4. ITEMS TO BE CHECKED BEFORE USING THIS PRODUCT	13
4.1. CHECKING THE PRODUCT	13
4.2. DEVICES TO BE FURNISHED BY THE CUSTOMER	13
5. HARDWARE SETTINGS	15
5.1. SETTINGS OF THE CC-LINK MASTER STATION	15
6. CONNECTIONS AND WIRING	16
6.1. MOUNTING THE CC-LINK INTERFACE CARD IN THE CONTROLLER	16
6.1.1. CR750-D/CR751-D CONTROLLER	16
6.1.2. CR1D-700 CONTROLLER	17
6.1.3. CR2D-700 CONTROLLER	18
6.1.4. CR3D-700 CONTROLLER	19
6.2. CONNECTION BETWEEN CC-LINK INTERFACE CARD AND MASTER STATION	20
6.2.1. CONNECTION OF ONE-TOUCH CONNECTOR AND CABLE ONLY FOR CC-LINK	20
6.2.2. CONNECTION OF CC-LINK MASTER-STATION UNIT AND CABLE ONLY FOR CC-LINK	21
6.2.3. CONNECTION OF THE ONE-TOUCH CONNECTOR AND THE CC-LINK INTERFACE CARD	22
6.2.4. CC-LINK COMMUNICATION CABLE WIRING OF TWO OR MORE SET CONNECTION	23
6.2.5. MEASURE AGAINST NOISE	24
6.3. CHECKING CONNECTIONS	26
7. BASIC COMMUNICATION PROCEDURE	27
7.1. SETTING THE PARAMETER OF CC-LINK MASTER STATION	28
7.2. SET THE PARAMETER OF THE ROBOT CONTROLLER	30
7.2.1. SETUP OF PARAMETER ABOUT CC-LINK INTERFACE CARD	30
7.2.2. SETUP OF SPECIAL I/O PARAMETER	31
7.3. CREATING A MASTER STATION CC-LINK PROGRAM	32
7.3.1. SIGNAL MAP OF MASTER STATION AND ROBOT	32
7.3.2. INSTALLATION OF SAMPLE RUDDER PROGRAM	32
7.3.3. FLOW CHART OF SAMPLE RUDDER PROGRAM	33
7.4. CREATE THE ROBOT PROGRAM NO. 1	34
7.5. START THE ROBOT PROGRAM NO. 1 FROM THE MASTER STATION	34
7.6. EXAMPLE OF CHANGE OF SYSTEM CONFIGURATION	35
7.6.1. ADD THE 2ND ROBOT CONTROLLER	35
7.6.2. ADD THE ROBOT CONTROLLER TO THE SYSTEM WHICH FOUR SLAVE STATIONS ARE CONNECTED	37
8. TROUBLESHOOTING	39

8.1.LIST OF ERRORS	39
8.2.AN E7730 ERROR HAS OCCURRED AND CC-LINK DOES NOT ESTABLISH A LINK.....	39
8.3.WHEN 7760 ERRORS (ABNORMALITIES IN CC-LINK INITIALIZATION) OCCUR.....	40
9. APPENDIX.....	41
9.1.SAMPLE LADDER PROGRAM.....	41

1. Before use

This chapter describes items to be checked and precautions to be taken before start using the CC-Link interface.

1.1. How to Use the Instruction Manual

This manual is organized as follows and describes functions that have been added to or changed in the CC-Link interface. For information about the functions provided for standard robot controllers and how to operate them, refer to the instruction manual that comes with the robot controller you purchased.

Table 1.1-1 Contents of the Instruction Manual

Chapter	Title	Description
1	Before Using the CC-Link Interface	Chapter 1 describes how to use this manual (CC-Link Interface Instruction Manual). Please read this manual thoroughly before actually starting to use the CC-Link interface.
2	Flow of Operations	Chapter 2 describes the operations required to configure a CC-Link system. Make sure to perform all of the required operations.
3	Functions and Specification of the CC-Link Interface	Chapter 3 describes the functions and specification of the robot CC-Link interface.
4	Items to Be Checked Before Using This Product	Chapter 4 provides a list of items that come with the CC-Link interface and the devices that need to be furnished by the customer. Please verify that the CC-Link interface package you purchased comes with the standard accessories and is compatible with your system's robot controller version.
5	Hardware Settings	Chapter 5 describes how to perform hardware settings for communication between the CC-Link interface and the master station.
6	Connections and Wiring	Chapter 6 describes how to connect the CC-Link interface and the master station using cables.
7	Basic Communication Procedure	Chapter 7 describes a series of operations using the newly installed CC-Link interface, configured and connected as described in Chapters 4 to 6, from creating a master station's CC-Link program to starting robot program No. 1. Learn how to perform the basic operations following the instructions given for each step as reference.
8	Troubleshooting	Chapter 8 describes how to resolve problems that may occur when using the CC-Link interface, such as malfunctions and errors. Please refer to this chapter as needed.
9	Appendix	Chapter 9 describes a sample ladder program that can be entered when using the CC-Link interface as well as how to monitor data with the RT ToolBox2 (personal computer support software). Please refer to this chapter as needed.

1.2. General name and abbreviated name







Table 1.2-1 General name and abbreviated name

General / abbreviated name	Details
Cyclic transmission	Remote input and output, a transmission means to communicate the details of the remote register periodically
Transient transmission	A transmission method to specify the partner to any timing and to communicate by 1:1
Master station	The station which controls the data link system The one station is required for the one system.
Standby master station	The station for backup which succeeds data link control when the master disconnected data link faulty by the abnormalities, such as sequencer CPU and the power supply
Local station	The station which has sequencer CPU and can communicate with the master station and other local stations
Remote I/O station	The station only treating the information on the bit unit
Remote device station	The station treating the information on the bit unit, and the information on the word unit
Intelligent device station	The station treating the information on the bit unit, and the information on the word unit, and also the transient transmission
Remote I/O net mode	Special mode which transmits and receives the data at the remote I/O station and the high speed
Remote net mode	The mode which can communicate with all the stations for CC-Link
SB (link special relay)	Information on the bit unit which shows the operating state and data link state of the unit of the master station and the local station
SW (link special register)	Information on the 16-bit unit which shows the operating state and data link state of the unit of the master station and the local station
RX (remote input)	Information inputted by bit unit into the master station from the slave station
RY (remote output)	Information outputted by bit unit into the master station from the slave station
RWw (remote register for the writing)	Information outputted to the remote device station, the local station, and the intelligent device station from the master station by 16 bits unit
RWr (remote register for reading)	Information inputted to the remote device station, the local station, and the intelligent device station from the master station by 16 bits unit

2. Flow of Operations

The flowchart below shows the flow of operations necessary for configuring a CC-Link interface system. Use it as a reference to perform the required operations in the correct order.

2.1. Flowchart

- 1 Determining Specification for CC-Link Control..... See Chapter 3 of this manual.
Once you understand the CC-Link specification, specify the interfaces required for signals to be communicated within your system via CC-Link communication (e.g., assignment of dedicated I/O signals, specification of general-purpose I/O signals).

- 2 Checking Products See Chapter 4 of this manual.
Check the product you have purchased and prepare other products as needed.

- 3 Hardware Settings and Wiring..... See Chapters 5 and 6 of this manual.
Set up the CC-Link interface card as well as the master station. After you have made the settings, install the CC-Link interface card in the robot controller, and then wire the installed CC-Link interface card and the master station.

- 4 Creating a Ladder Program for the Master Station See Section 7.1 of this manual.
Create a ladder program for the master station so that it can be linked to the robot controller.* If the robot controller is started without running a ladder program stored in the master station, an E7730 error (CC-Link local station link error) occurs.

- 5 Setting Robot Controller Parameters..... See Section 7.2 of this manual.
Set dedicated I/O signals for communication between the master station and the robot controller. With this setting, it becomes possible to control the robot controller from the master station.

- 6 Creating Robot Programs..... See Section 7.3 of this manual.
Create robot programs according to the specification determined in Operation 1 above.

- 7 Performing CC-Link Control See Section 7.4 of this manual.
Run the ladder program stored in the master station and perform control via the CC-Link communication.

- 8 Completion of Operations

3. Functions and Specification of the CC-Link Interface

3.1. What Is CC-Link?

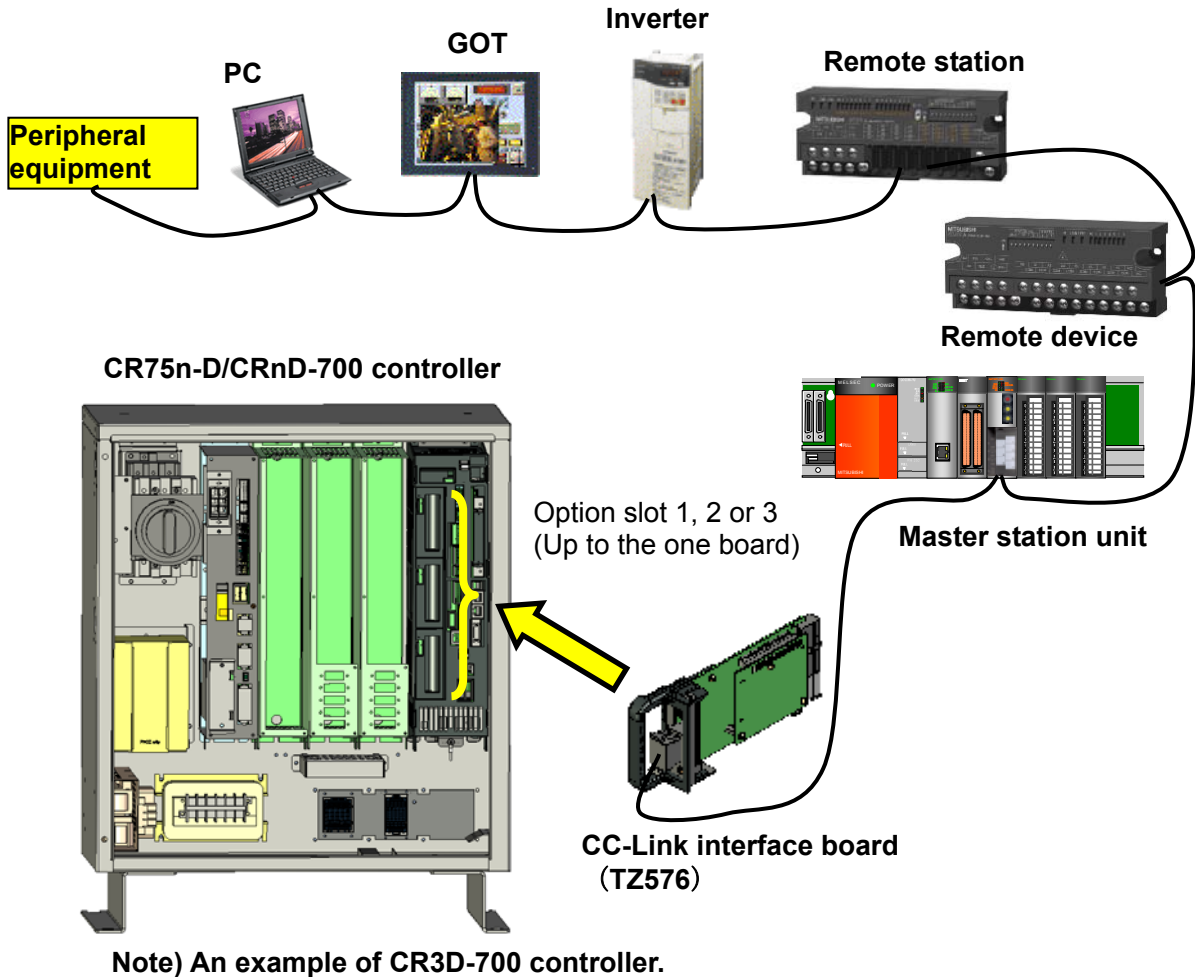

Table 3.1-1 CC-Link Network Configuration Diagram

CC-Link is a field network (*1) that provides not only simple bit control but also additional functions such as data control and message transmission/reception in order to accommodate the continuous advances in the functionality of various control devices. CC-Link supports cyclic transmission of not only bit data but also word data, facilitating communication with intelligent devices such as inverters, indicators and other I/O devices. Distributed systems can be built easily by setting up an n:n cyclic transmission network to which a master station and several local stations are connected. The best communication distance and speed can be selected in a flexible manner according to your system requirements. The optimal system can be built by selecting the most suited devices from the rich product lines of the CC-Link partner manufacturers.

This CC-Link interface card operates as an intelligent device station.

(*1) Please visit the Web site of the CC-Link Partner Association (<http://www.cc-link.org/>) for more information about CC-Link.

3.2. Specification of the CC-Link Interface Card

Table 3.2-1 General Specification (Specification of HR575 Card)

Item		Specification	Remarks
Communication function		Both bit data and word data can be transmitted.	Word data is used in the registers.
Type name of CC-Link interface card		TZ576	
Mountable option slot		1, 2, or 3	Use one of the slots
Number of mountable cards		1 card	It is not allowed to insert multiple cards.
Version corresponding to CC-Link		Ver.2	The extended cyclic setup is possible
Station type		Intelligent device station	Transient transmission is not supported.
Supported station functionality		Local station	Master station functionality is not available.
Station number		Can be set between station numbers 1 and 64	Set using the dip switches on the card.
Baud rate		10 M, 5 M, 2.5 M, 625 k, 156 kbps	If two or more station occupancy, it becomes the continuation station number.
Number of occupied stations		Can be set to occupy 1, 2, 3, or 4 stations.	
Extended cyclic setup		Can be set to 1, 2, 4, or 8 multiple.	
Number of I/O points	Remote input (RX)	896 max.	The last two points cannot be used.
	Remote output (RY)	896 max.	
	Remote register (RW _r)	128 max.	One register consists of 16 bits.
	Remote register (RW _w)	128 max.	
	Transient transmission	Not supported	
Parameter		Initial value	
Special I/O	STOP2	-1, -1	Refer to "Table 3.2 3 List of Robot Parameters Used in CC-Link" for details.
	DIODATA	-1, -1	
Common	CCERR	0	
	E7730	0	
	CCINFO	1, 1, 1	
	CCSPD	4	
	CCCLR	0	
	CCFIX	1	
	CCFIL	1000, 200	
CCREFCYC	1		
MELFA-BASIC	I/O signal access	M_In/ M_Inb/ M_In8 / M_Inw/ M_In16 M_Out/ M_Outb/ M_Out8/ M_Outw/ M_Out16	
	Register access	M_DIn, M_DOut	

Table 3.2-2 I/O point per robot controller

Item		Extended cyclic setup							
Occupancy station	Signal	1 fold setup		2 fold setup		3 fold setup		4 fold setup	
One station	I/O signal	32	point	32	point	64	point	128	point
	Register	4	point	8	point	16	point	32	point
Two-station	I/O signal	64	point	96	point	192	point	384	point
	Register	8	point	16	point	32	point	64	point
Three-station	I/O signal	96	point	160	point	320	point	640	point
	Register	12	point	24	point	48	point	96	point
Four-station	I/O signal	128	point	224	point	448	point	896	point
	Register	16	point	32	point	64	point	128	point

Table 3.2-3 List of Robot Parameters Used in CC-Link

Item	Function
STOP2	Set the input number for stopping the robot program from the CC-Link master station to the 1st element. Set the output number which indicates that the robot program is stopping to the 2nd element
DIODATA	Set the register input number when specifying the program number and OVRD to the 1st element. Set the program number, the error number, and the register output number that outputs the number of the lines to the 2nd element.
CCERR	If the CC-Link master station is not turned on or if doing the operations of the robot stand alone before setting the parameter of the master station, the 7750 errors (the cc-Link master-station parameter is unusual) or the 7730 errors (the cc-Link link is unusual) occur This parameter enables reset of error temporarily. 0: If the link is abnormal, always error 1: Reset is possible * This parameter is the power supply reset needlessness of the robot controller.
E7730	This parameter enables reset of 7730 errors (the cc-Link link is unusual) temporarily. 0: If the link is abnormal, always error 1: Reset is possible * This parameter is the power supply reset needlessness of the robot controller.
CCINFO	There are the three elements of this parameter and they set up the number of CC-Link, the number of occupancy station, and the extended cyclic setup separately. (Element 1 = Number : 1 to 64 stations) (Element 2 = Number of occupancy station : 1 to 4 stations) (Element 3 = Extended cyclic setup : Set up 1, 2, 4, or the 8 fold.)
CCSPD	Set up the transmission speed of CC-Link. (0: 156k / 1: 625k / 2: 2.5M / 3: 5M / 4: 10M)
CCCLR	When the abnormalities in the data link occur, specify whether the input signal is held or it clears. 1: Hold 0: Clear
CCFIX	Set up whether the CC-Link signal number is fixed or not. 0: Use the signal number of the specified station number. (Ex.) Set the station number as 3. I/O signal number = from No. 6064 / Register number = from No. 6008 1: Use the signal number from No. 6000 regardless of the station number. (Ex.) Set the station number as 3. I/O signal number = from No. 6000 / Register number = from No. 6000.
CCFIL	Set up the master-station parameter abnormal detection filter and the data link abnormal detection filter. The unit is ms. If only the time specified by each abnormal condition is being continued, the 7750 errors and the 7730 errors occur.

Item	Function
CCREFCYC	<p>Change the update cycle of the CC-Link interface. High-speed mode/Compatibility mode = 1/0 In the software version P7th edition or later the updating cycle of the CC-Link interface was accelerated. If "0" is set up, it will operate in same updating cycle as before. This is available if the compatibility with the robot system constructed by the software version prior to P7 edition is necessary. The updating cycle of the input-output signal was sped up in the following software versions: CRnD-700 series controller: Ver.P7 or later CR750-D/CR751-D series controller: S3 or later</p>

Table 3.2-4 List of Robot Program Commands Used in CC-Link

Item	Function
M_In	Reads 1-bit data of the specified input signal
M_Out	Writes 1-bit data to the specified output signal
M_Inb/ M_In8	Reads 8-bit data from the specified input signal
M_Outb/ M_Out8	Writes 8-bit data to the specified output signal
M_Inw/ M_In16	Reads 16-bit data from the specified input signal
M_Outw/ M_Out16	Writes 16-bit data to the specified output
M_Din	Reads data of the specified input register
M_DOut	Writes data to the specified output register

Table 3.2-5 Signal table

(1) In case of the parameter "CCFIX" is "1" in CC-Link Ver.2

Station number	Occupancy station	Extended cyclic setup	Remote signal		Remote register	
			Input	Output	Input	Output
0(Master)	-	-	-	-	-	-
1 to 64	One station	1 fold	6000 to 6031	6000 to 6031	6000 to 6003	6000 to 6003
		2 fold	6000 to 6063	6000 to 6063	6000 to 6007	6000 to 6007
		4 fold	6000 to 6095	6000 to 6095	6000 to 6015	6000 to 6015
		8 fold	6000 to 6127	6000 to 6127	6000 to 6031	6000 to 6031
	Two station	1 fold	6000 to 6063	6000 to 6063	6000 to 6007	6000 to 6007
		2 fold	6000 to 6095	6000 to 6095	6000 to 6015	6000 to 6015
		4 fold	6000 to 6191	6000 to 6191	6000 to 6031	6000 to 6031
		8 fold	6000 to 6383	6000 to 6383	6000 to 6063	6000 to 6063
	Three station	1 fold	6000 to 6095	6000 to 6095	6000 to 6011	6000 to 6011
		2 fold	6000 to 6159	6000 to 6159	6000 to 6023	6000 to 6023
		4 fold	6000 to 6319	6000 to 6319	6000 to 6047	6000 to 6047
		8 fold	6000 to 6639	6000 to 6639	6000 to 6095	6000 to 6095
	Four station	1 fold	6000 to 6127	6000 to 6127	6000 to 6015	6000 to 6015
		2 fold	6000 to 6223	6000 to 6223	6000 to 6031	6000 to 6031
		4 fold	6000 to 6447	6000 to 6447	6000 to 6063	6000 to 6063
		8 fold	6000 to 6895	6000 to 6895	6000 to 6127	6000 to 6127

***The last two points cannot be used.**

(2) In case of the parameter "CCFIX" is "1" in CC-Link Ver.1

Station number	Occupancy station	Extended cyclic setup	Remote signal		Remote register	
			Input	Output		
0(Master)	-	-	-	-	-	-
1 to 64	One station	1 fold only	6000 to 6031	6000 to 6031	6000 to 6003	6000 to 6003
	Two station		6000 to 6063	6000 to 6063	6000 to 6007	6000 to 6007
	Three station		6000 to 6095	6000 to 6095	6000 to 6011	6000 to 6011
	Four station		6000 to 6127	6000 to 6127	6000 to 6015	6000 to 6015

***The last two points cannot be used.**

Table 3.2-6 Table of CC-Link Signals

(The numbers in the table indicate the numbers of the I/O signals handled by the robot controller.)

Station number	Remote signal		Remote register	
	Input	Output	Input	Output
0 (master)				
1	6000 to 6031	6000 to 6031	6000 to 6003	6000 to 6003
2	6032 to 6063	6032 to 6063	6004 to 6007	6004 to 6007
3	6064 to 6095	6064 to 6095	6008 to 6011	6008 to 6011
4	6096 to 6127	6096 to 6127	6012 to 6015	6012 to 6015
5	6128 to 6159	6128 to 6159	6016 to 6019	6016 to 6019
6	6160 to 6191	6160 to 6191	6020 to 6023	6020 to 6023
7	6192 to 6223	6192 to 6223	6024 to 6027	6024 to 6027
8	6224 to 6255	6224 to 6255	6028 to 6031	6028 to 6031
9	6256 to 6287	6256 to 6287	6032 to 6035	6032 to 6035
10	6288 to 6319	6288 to 6319	6036 to 6039	6036 to 6039
11	6320 to 6351	6320 to 6351	6040 to 6043	6040 to 6043
12	6352 to 6383	6352 to 6383	6044 to 6047	6044 to 6047
13	6384 to 6415	6384 to 6415	6048 to 6051	6048 to 6051
14	6416 to 6447	6416 to 6447	6052 to 6055	6052 to 6055
15	6448 to 6479	6448 to 6479	6056 to 6059	6056 to 6059
16	6480 to 6511	6480 to 6511	6060 to 6063	6060 to 6063
17	6512 to 6543	6512 to 6543	6064 to 6067	6064 to 6067
18	6544 to 6575	6544 to 6575	6068 to 6071	6068 to 6071
19	6576 to 6607	6576 to 6607	6072 to 6075	6072 to 6075
20	6608 to 6639	6608 to 6639	6076 to 6079	6076 to 6079
:	:	:	:	:
63	7984 to 8015	7984 to 8015	6248 to 6251	6248 to 6251
64	8016 to 8047	8016 to 8047	6252 to 6255	6252 to 6255

**CAUTION**

In case of the inside signal point of the robot is exceeded, be careful of the point decreasing.

If the parameter "CCFIX" is set as "0" in CC-Link Ver.2, access from the signal number corresponding to the station number. For this reason, the following cares are required if the station number becomes large.

In the 8 fold setup by four-station occupancy of the robot, the signal point number of I/O signal is 896, and for registers is 128 words.

However, when the number is set as the 64 stations, the permissible signal points in the robot are the remaining 32 points (8016-8047) and the 4 words (6252-6255).

For this reason, since the set-up point cannot be used, be careful.

3.3. Hardware of the CC-Link Interface Card

This section describes the settings that are performed by using the rotary switches and DIP switches on the CC-Link interface card.

3.3.1. Card overview

(1) General Layout of the Card

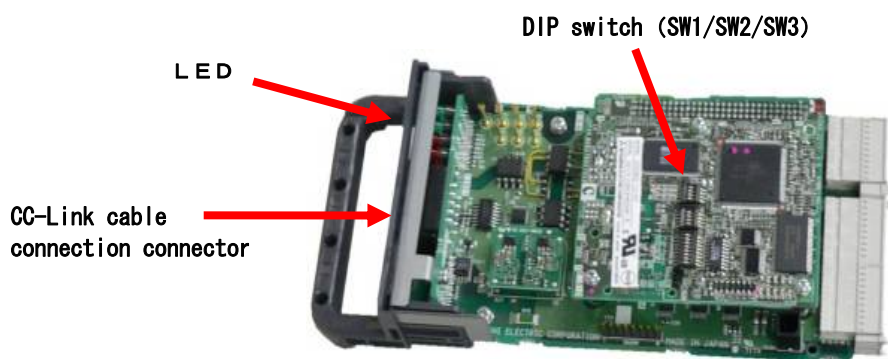

Figure 3.3-1 General Layout of the Card

3.3.2. DIP switch

There are the three DIP switches (SW1 / SW2 / SW3) on the CC-Link interface card (TZ576). The item which can be set up with each DIP switch is shown in the following.



Table 3.3-1 Function of DIP switch (SW1)

Switch	OFF	ON	Factory setting	Description	
SW1	1	ON (fixation)		ON	
	2	Ver.1 mode	Ver.2 mode	ON	Specify the version of CC-Link. In case of the Ver.2 mode, the extended cyclic setup is possible.
	3	OFF (fixation)		OFF	
	4	OFF (fixation)		OFF	

Please change neither SW2 nor SW3 like an initial value (turn off all).
The initial state of each switch is shown in the following.

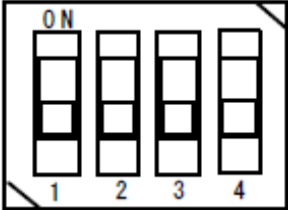

Figure 3.3-2 State of initialization of dip switch (SW2)

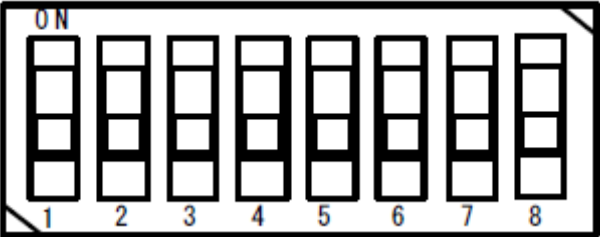

Figure 3.3-3 State of initialization of dip switch (SW3)

3.3.3. LED

There is eight LED on the CC-Link interface card (TZ576), and the operating state of the interface card can be confirmed by each lighting / blink / lights-out.

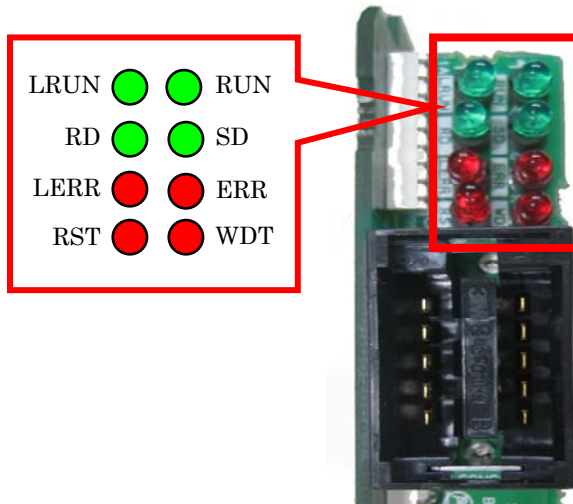

Figure 3.3-4 Layout of LEDs

Table 3.3-2 Description of LED

LED name	Conditions for turning on	
LRUN	Lighting	During data link
RD	Lighting	During data receiving
LERR	Lighting	Self-station communication error
	Blink	The DIP switch is changed during turning on the power supply
RST	Lighting	During reset processing execution of the interface card
RUN	Lighting	Operation is normally
	Lighting	Watch dog timer error
SD	Lighting	During data sending
ERR	Lighting	Turn on at the following error occurrence. The communication of all station are abnormal The setup of the DIP switch is abnormal The master station overlaps on the same line. The details of the parameter are abnormal. The data link monitor timer operated The cable is disconnected The noise is effect to the transmission way
		Blink
WDT	Lighting	Watch dog timer error

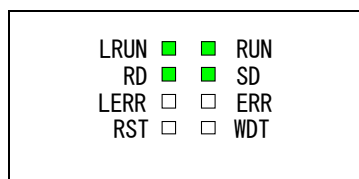

Figure 3.3-5 The LED lighting state at normal

4. Items to Be Checked Before Using This Product

4.1. Checking the Product

The product you purchased consists of the following items as standard. Please verify that the package contains all the items.

Table 4.1-1 List of the Standard Items in the Package

No. ^{Note1)}	Name	Type	Quantity
①	Instruction Manual (this manual) ^{Note2)}	BFP-A8701	1
②	CC-Link interface card	TZ576	1
③	Ferrite core	E04SR301334	2
④	On-line connector for communication	A6CON-LJ5P	1
⑤	Terminator	A6CON-TR11	1
⑥	One-touch connector plug for communication	A6CON-L5P	2
⑦	Cable clamp	AL5	2
⑧	Cable clamp	AL4	2

Note1) The number of the table is equivalent to the number of following figure.

Note2) This manual is included in instruction-manual CD-ROM attached to the product.

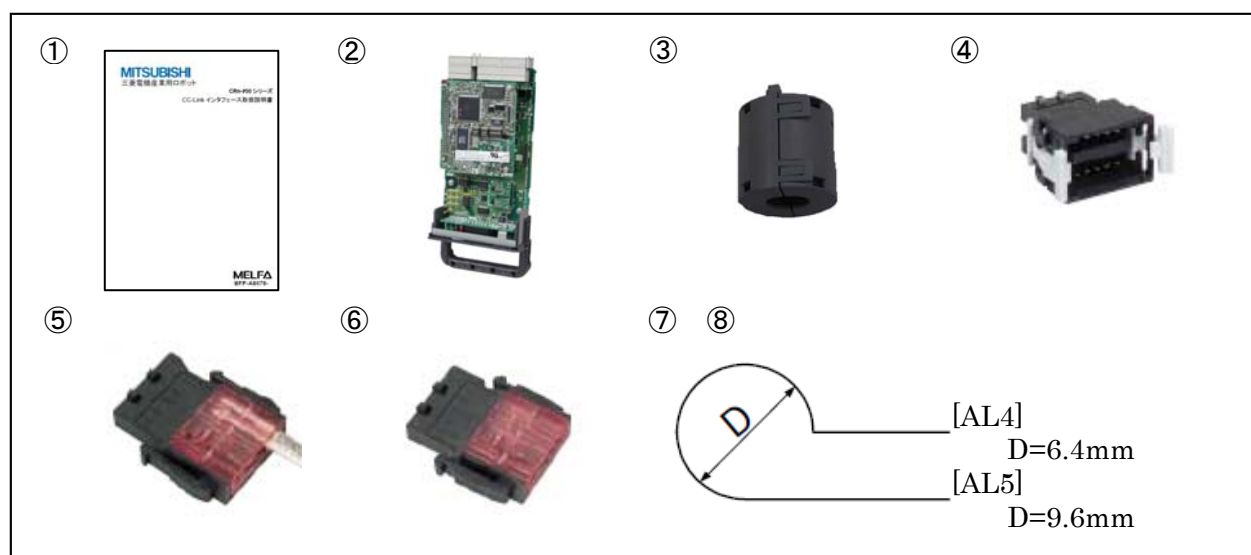

Figure 4.1-1 Items Contained in the Package

4.2. Devices to Be Furnished by the Customer

When using Mitsubishi Electric CC-Link interface card, the devices listed in Table 4.2 below must be furnished by the customer.

Table 4.2-1 Equipment prepared of the customer

Device to be furnished	Condition
Master station	The master station corresponding to the intelligent device station
Communication cable *1)	The cable only for CC-Link Performance of the CC-Link system cannot be guaranteed except the cable only for CC-Link. The maximum cable total extension and the cable length for the station have restriction. Note) If extended cyclic setting is set up more than double, transmission delay time will become long. Refer to the instruction manual of CC-Link for details.

*1) For details, refer to "the cc-Link association (<http://www.cc-link.org/>)."

5. Hardware Settings

5.1. Settings of the CC-Link Master Station

The details of the setting of the master station are shown in the following. For details, please refer to "the cc-Link system master local unit user's manual (volume on details)."

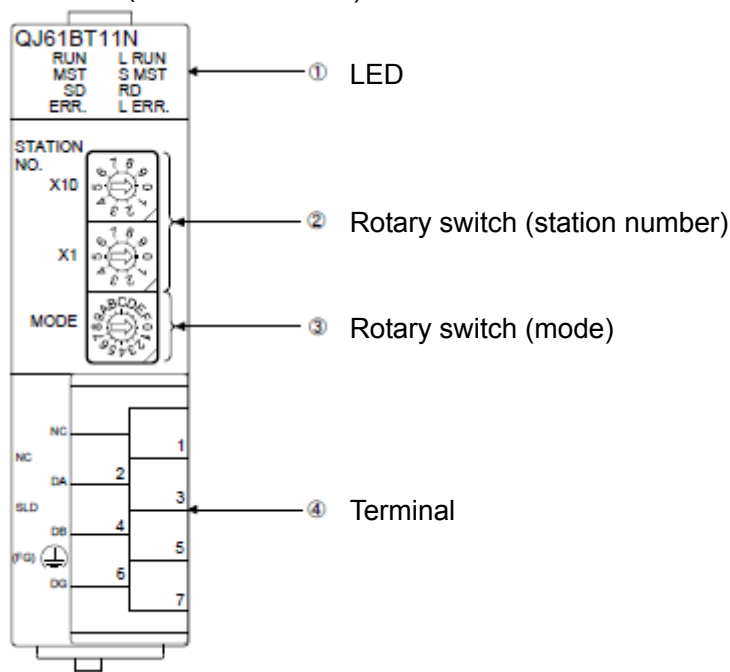

Figure 5.1-1 The outline of the CC-Link master-station unit (Q series)

As shown in Table 5-1, set up the rotary switch of the CC-Link master-station unit. For details, please refer to "the cc-Link system master local unit user's manual (volume on details)."

Table 5.1-1 The setup of the CC-Link master-station unit (Q series)

Item		Details of setting	At shipping	Example of setting
Rotary switch	② Station number	X10 : Set the ten digit of a station number	0	0
		X1 : Set the ten digit of a station number	0	0
	□ Mode	Set the mode 0 : Transmission speed 156kbps 1 : Transmission speed 625kbps 2 : Transmission speed 2.5Mbps 3 : Transmission speed 5Mbps 4 : Transmission speed 10Mbps	0	4

Notice) When the mode of the master station is changed, change the parameter "CCSPD" of the robot controller.

6. Connections and Wiring

6.1. Mounting the CC-Link Interface Card in the Controller

For more information about how to mount the CC-Link interface card, refer to the "Installing Optional Devices" in "Controller Setup and Basic Operations to Maintenance" in the instruction manual of the corresponding controller. Install only one CC-Link interface card in either of the option slots 1-3 of the robot controller. In case of the two or more sheets are installed, the 7720 errors (equipped with two or more cc-Link cards) occur.

6.1.1. CR750-D/CR751-D controller

Remove one interface cover of the option slots two in the robot controller rear, and mount the CC-Link interface card there. Please use the handle of the interface card at mounting of the interface card.

<CR750-D controller rear>

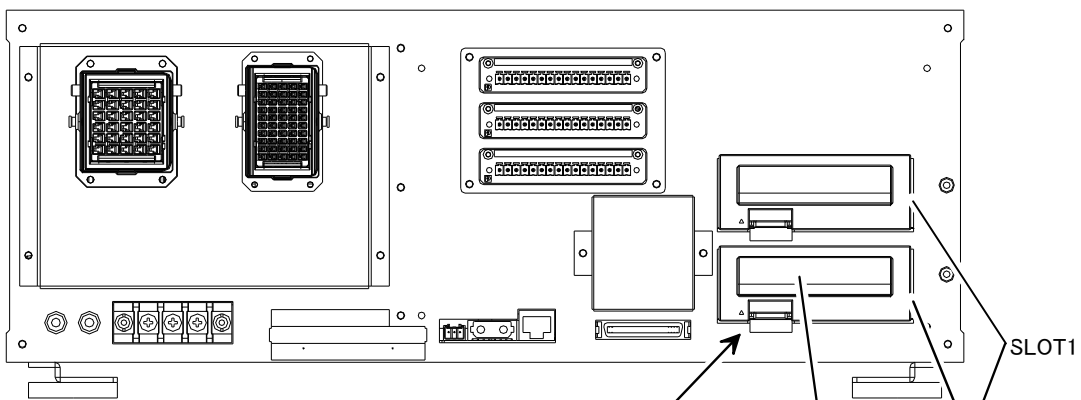

<CR751-D controller front>

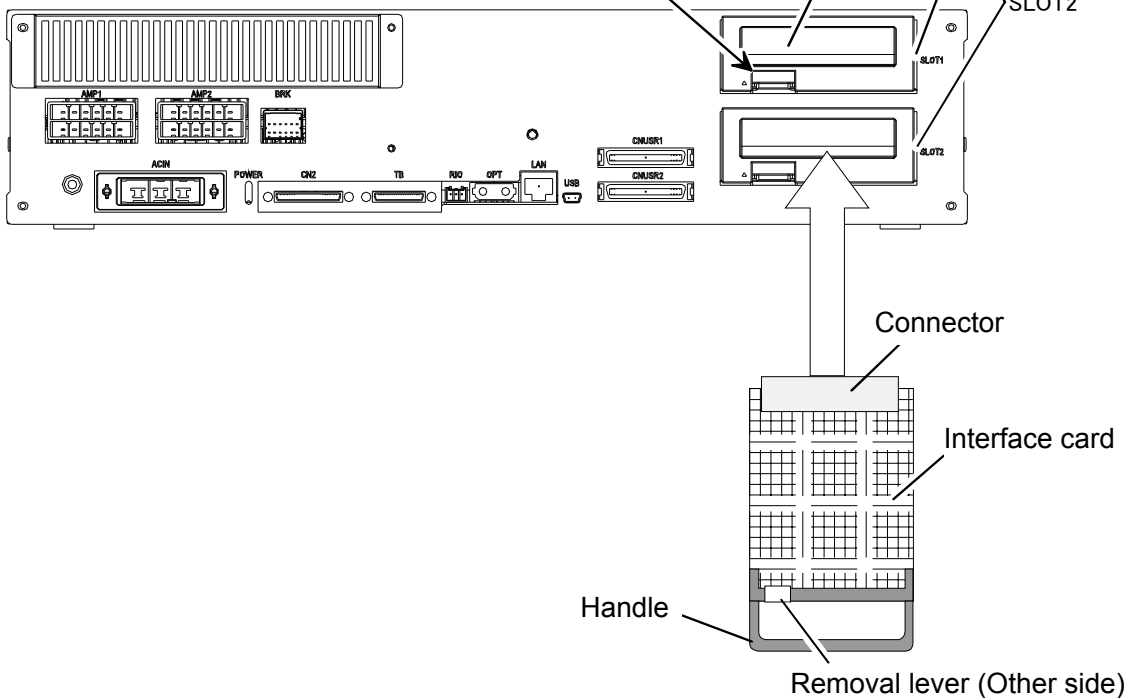

Figure 6.1-1 Mounting of the CC-Link interface card (CR750-D/CR751-D controller)

6.1.2. CR1D-700 controller

Remove one interface cover of the option slots 1 in the robot controller rear, and mount the CC-Link interface card there. Please use the handle of the interface card at mounting of the interface card.

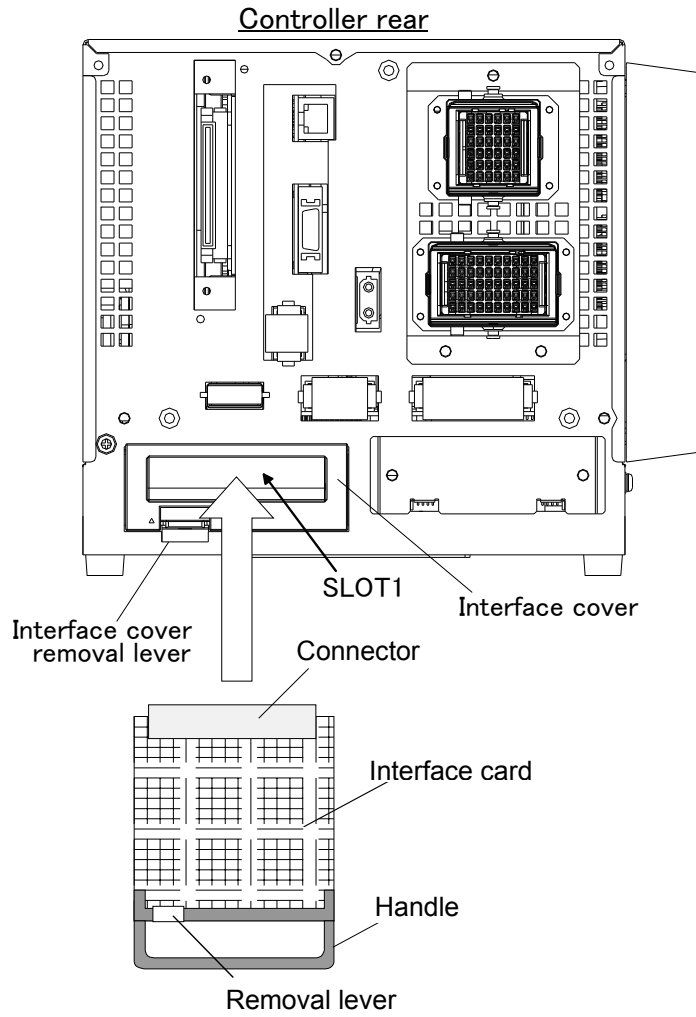

Figure 6.1-2 Mounting of the CC-Link interface card (CR1D controller)

6.1.3. CR2D-700 controller

Remove one interface cover of the option slots 1-3 in the robot controller rear, and mount the CC-Link interface card there. Please use the handle of the interface card at mounting of the interface card.

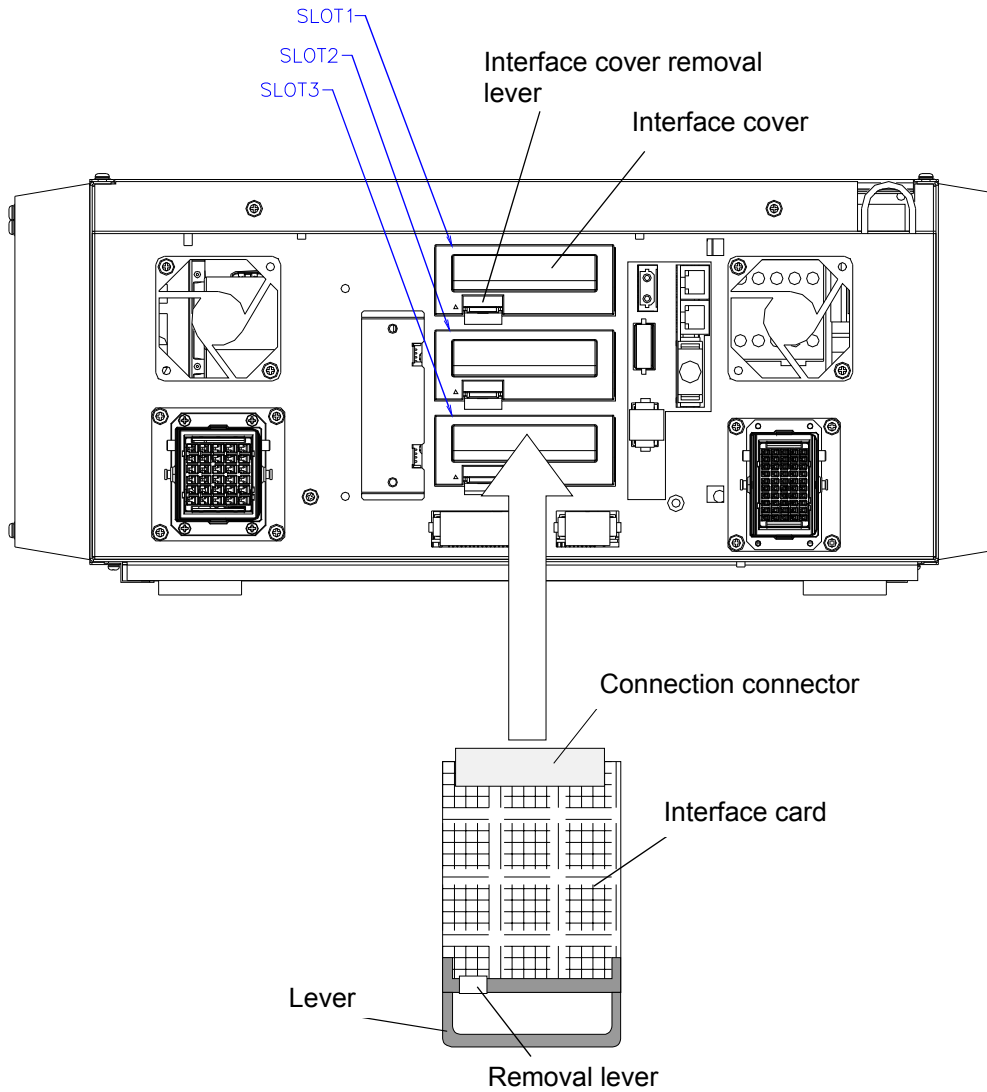

Figure 6.1-3 Mounting of the CC-Link interface card (CR2D controller)

6.1.4. CR3D-700 controller

Open the door of the robot controller.

The R700CPU unit is installed in the right end. Remove one interface cover of the option slots 1-3 in the CPU unit, and mount the CC-Link interface card there.

Please use the handle of the interface card at mounting of the interface card.

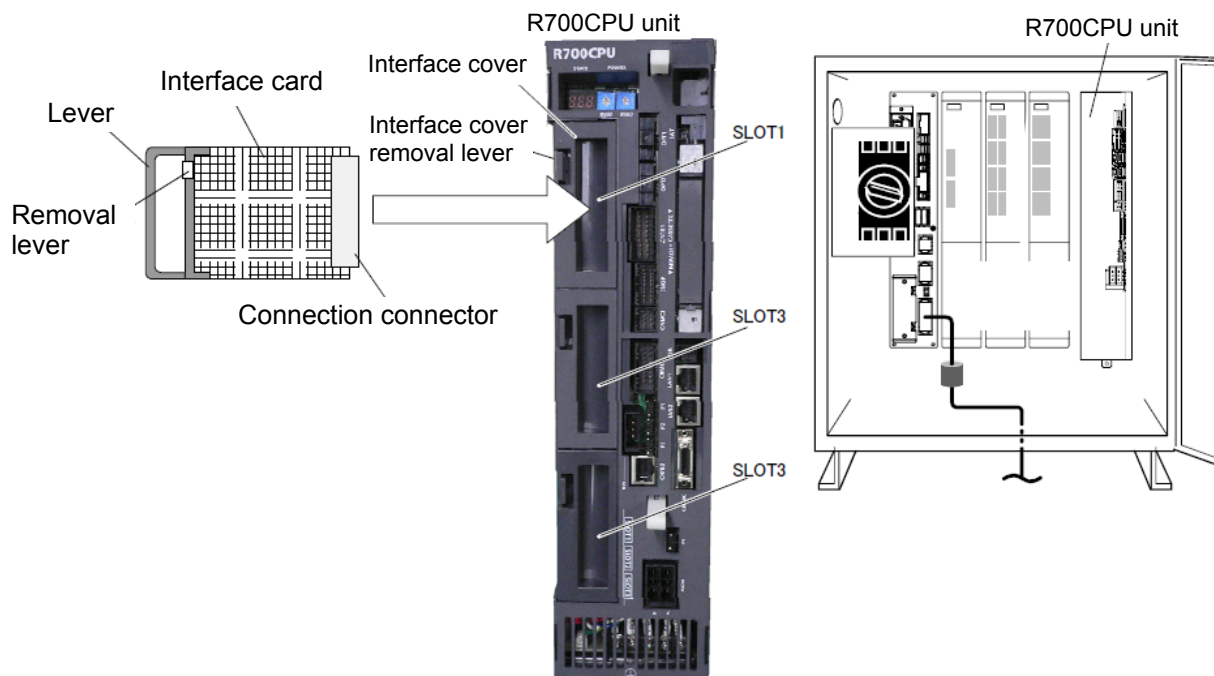

Figure 6.1-4 Mounting of the CC-Link interface card (CR3D controller)

6.2. Connection Between CC-Link Interface card and Master Station

Explain the connection method for the CC-Link interface card mounted in the robot controller, and the CC-Link master-station unit.

6.2.1. Connection of one-touch connector and cable only for CC-Link

Connection method of the cable for CC-Link only prepared by the customer and one-touch connector attached to this product is shown in the following.

- (1) Peel covering of the cable only for CC-Link (It is not necessary to peel covering of the internal cable)

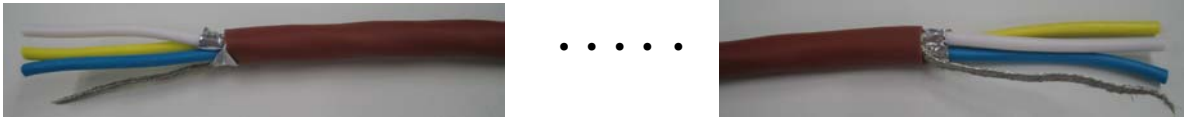

- (2) Insert the electric wire of the cable for CC-Link to the one-touch connector.

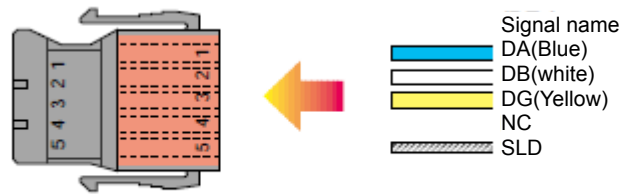
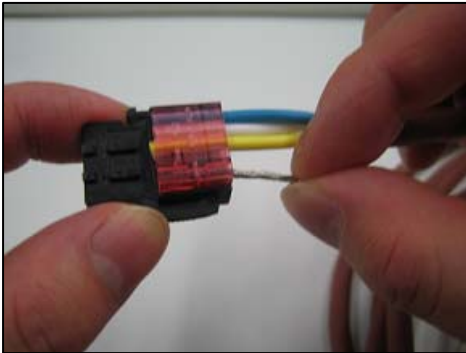

- (3) Close the connector with pliers



- (4) Complete



6.2.2. Connection of CC-Link master-station unit and cable only for CC-Link

The connection method of the CC-Link master-station unit prepared by the customer and the CC-Link cable is shown in the following.

- (1) Stick another side of the CC-Link cable by pressure.

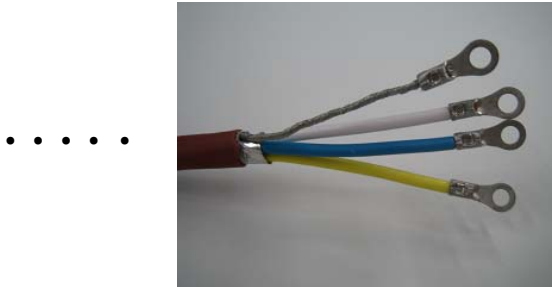

- (2) Connect the shield line to the SLD terminal in the terminal of the master-station unit. Refer to the lower right figure

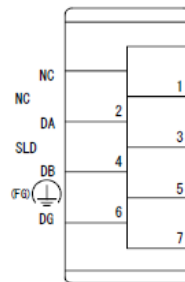
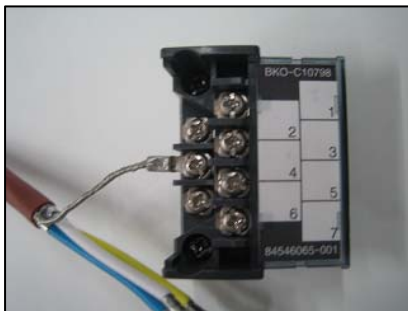

- (3) Connect the electric wire to DA, DB and DG in the terminal of the master-station unit.

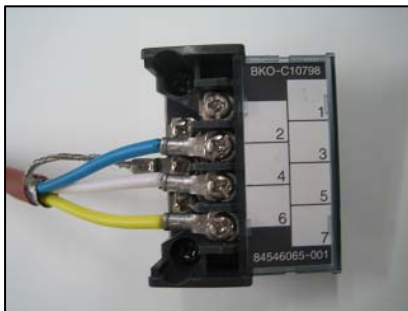

- (4) Connect the terminal to the master-station unit.

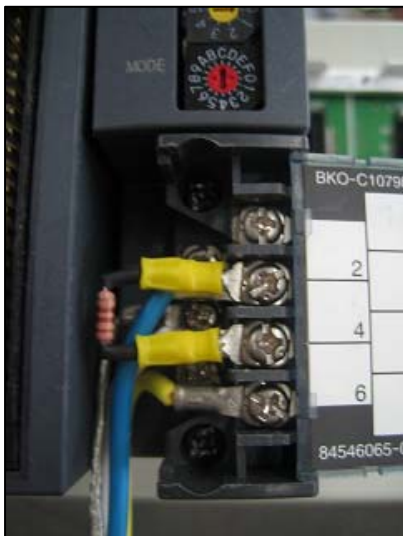

⚠ Point

Installation of the terminator is required for the both ends of the CC-Link network.

Connect the terminator to the both ends of the equipment connected to the CC-Link network. Be careful that the resistance differs with the kind of cable.

6.2.3. Connection of the one-touch connector and the CC-Link interface card

The connection method of the one-touch connector (cable only for cc-Link) and the CC-Link interface card is shown in the following.

- (1) Connect the one-touch connector to the on-line connector for communication. Also connect the terminator if needed.



- (2) Connect the on-line connector for communication (connected communication cable) to the CC-Link interface card.

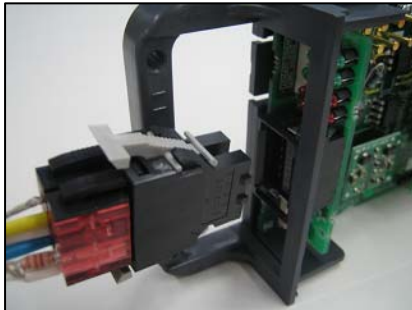

By the operations so far, it becomes the following system configurations.

An example of CR3D-700 controller

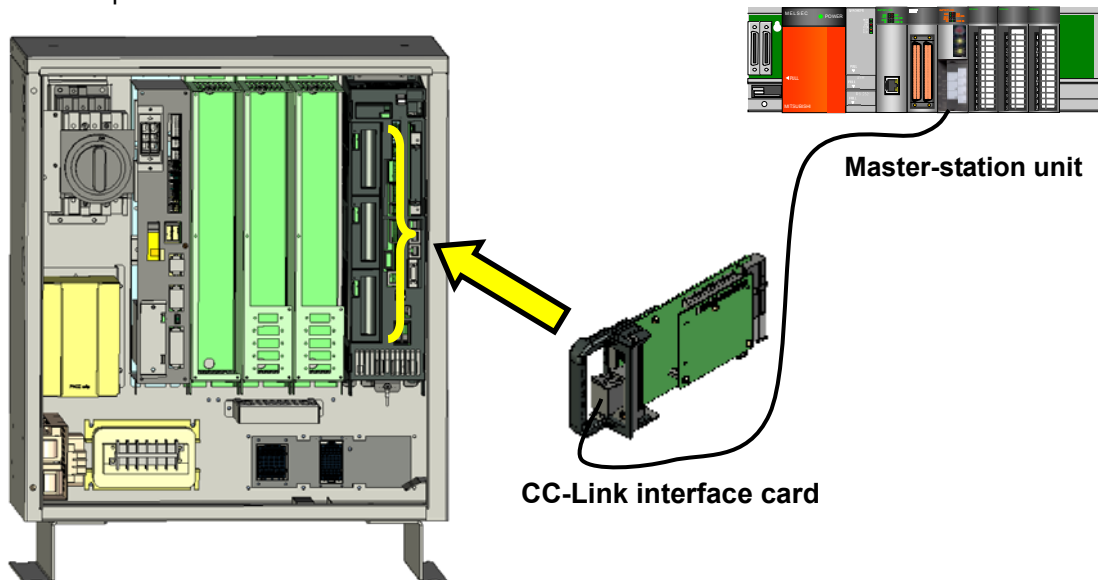

Figure 6.2-1 The 1 to 1 connection structure figure of the robot controller and the CC-Link master station (CR3D-700 controller)

6.2.4. CC-Link communication cable wiring of two or more set connection

If two or more slave stations connected, prepare one more CC-Link cable connected to the one-touch connector, and connect as shown in the following



Figure 6.2-2 The example of one-touch connector connection for two or more station connection

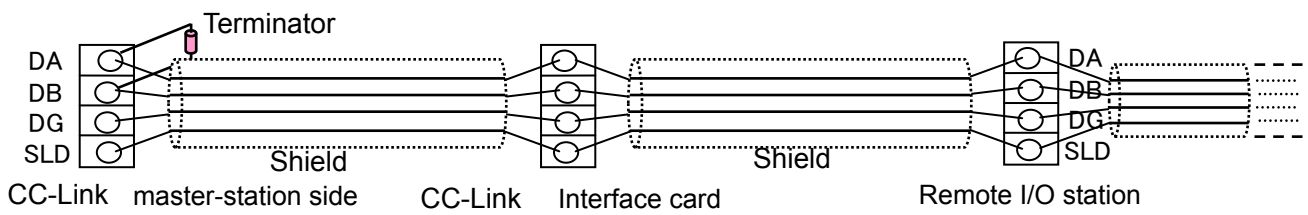

Figure 6.2-3 The example of CC-Link cable connection for two or more station connection

6.2.5. Measure against noise

Because of the measure against the noise, please peel the sheath of the CC-Link cable, and the ground clamp of the metal braid section at the case, and mount the ferrite core (recommendation article: E04SR301334 * SEIWA ELECTRIC MFG.) on less than 30cm from the clamp position. The connection method by controller is shown in the following.

(1) CR750-D/CR751-D controller

<CR750-D controller rear>

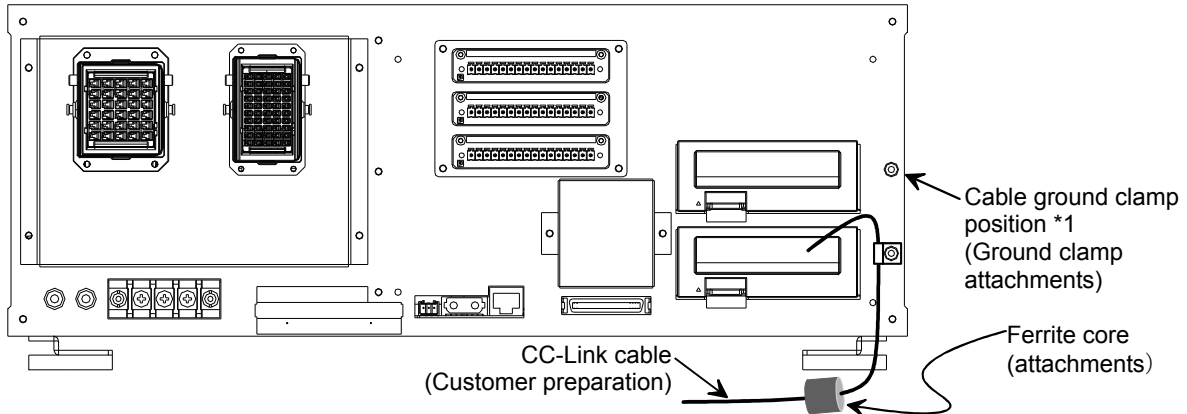

<CR751-D controller front >

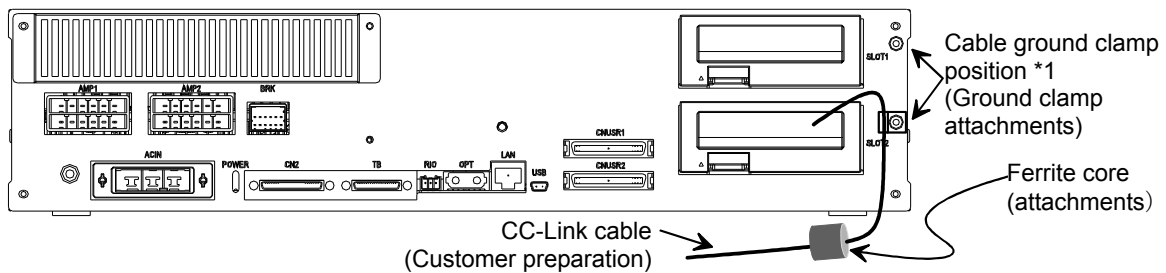

Figure 6.2-4 Connection of the CC-Link cable (CR750-D/CR751-D controller)

(2) CR1D-700 controller

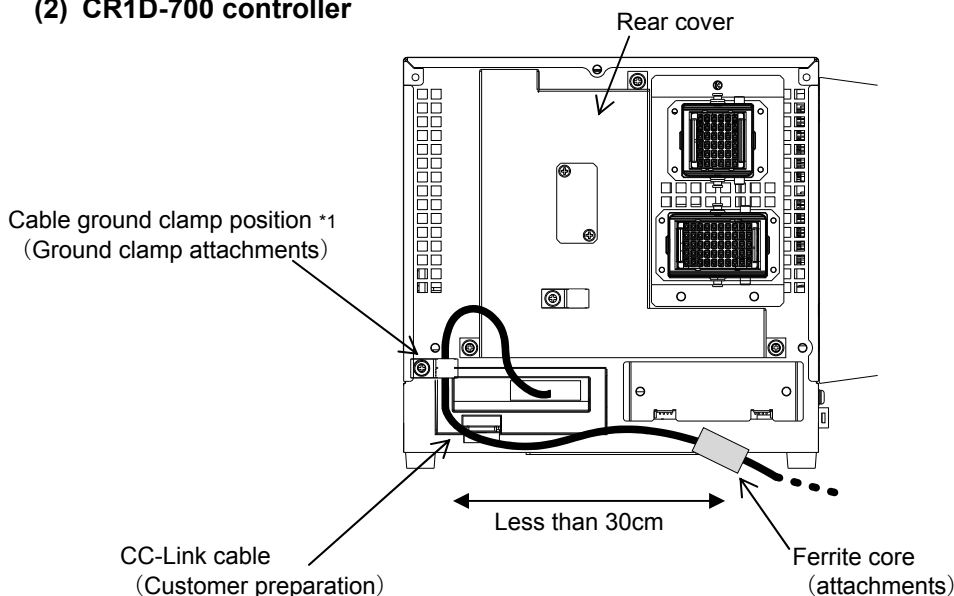

Figure 6.2-5 Connection of the CC-Link cable (CR1D-700 controller)

(3) CR2D-700 controller

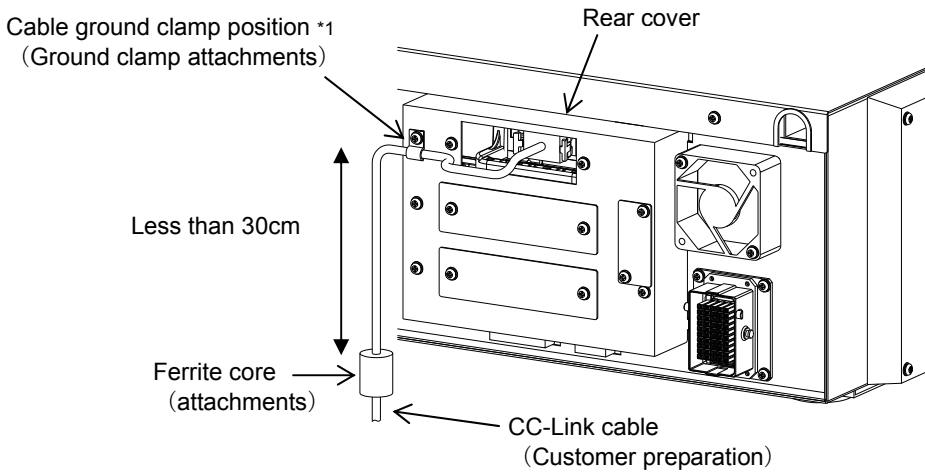

Figure 6.2-6 Connection of the CC-Link cable (CR2D -700 controller)

(4) CR3D-700 controller

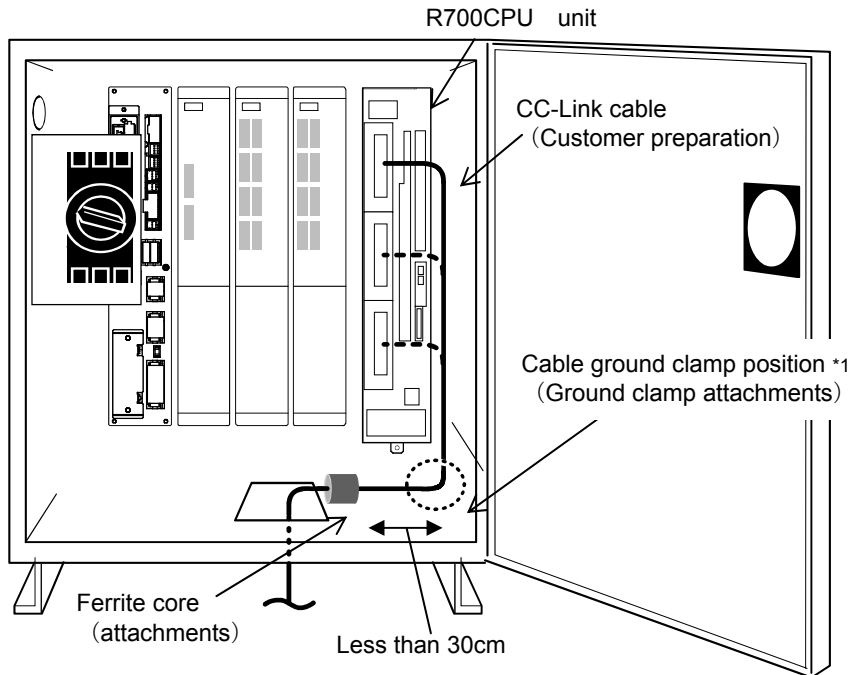
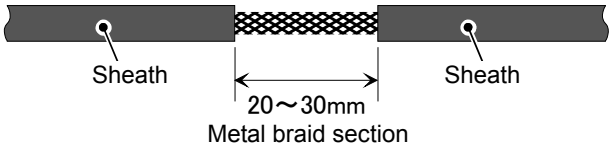

Figure 6.2-7 Connection of the CC-Link cable (CR3D -700 controller)

*1)
Cable ground clamp position
The cable peels the sheath and grounds the metal braid section to the case.



6.3. Checking Connections

Check the following connections again before using the CC-Link interface card.

Table 6.3-1 Checking Connections

No.	Check item	Check
1	Is the CC-Link interface card securely installed in slot of the controller?	
2	Are the CC-Link cables between the CC-Link interface card and the external devices you provided connected properly?	
3	Are the rotary switches and DIP switches on the card set correctly?	
4	Is a terminal resistor installed?	
5	Is the ferrite core attached?	

7. Basic Communication Procedure

This chapter describes the operations from creating a master station's CC-Link program to establishing a communication by running the sample ladder program provided with this product, using a system configured with one CC-Link interface card connected to one PLC master station module (one-to-one connection).

The sample ladder program provided starts up robot program No. 1.

*** For information about communication via the personal computer CC-Link interface board, refer to the instruction manual of the personal computer CC-Link interface board.**

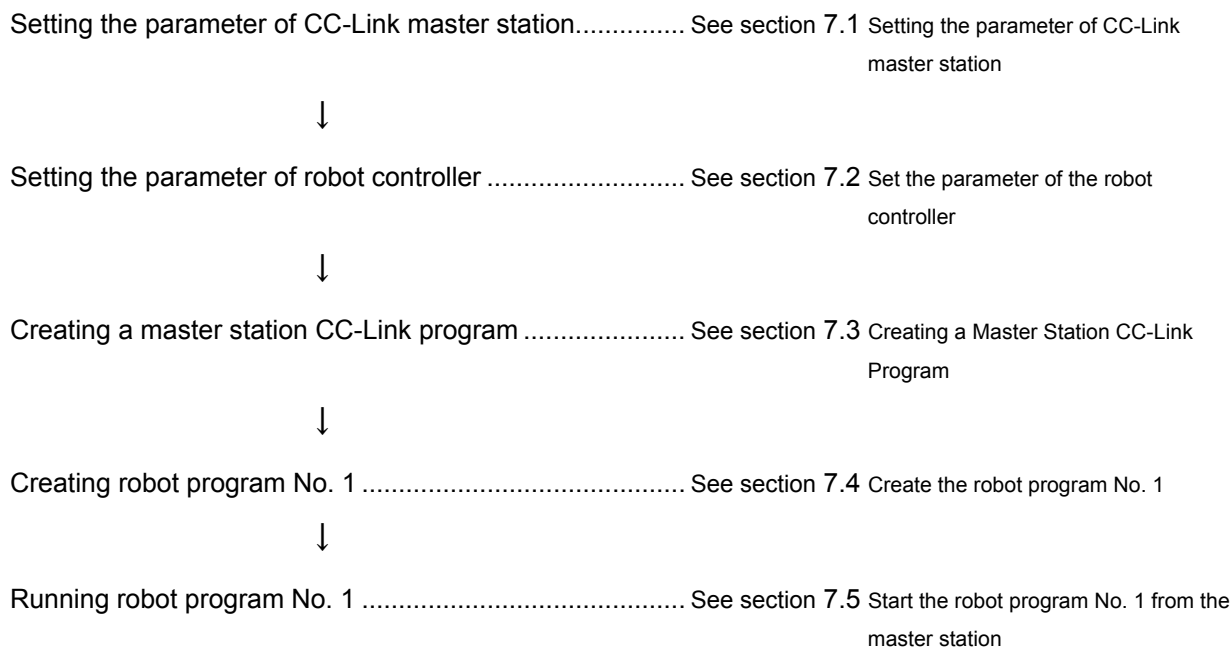

7.1. Setting the parameter of CC-Link master station

Set it as the CC-Link master station that the robot's CC-Link interface card exists on the CC-Link network. In case of Q series of the MELSEC sequencer, explain to the example the case that the utility for setting the parameter for CC-Link communication is used.

In addition, please refer to "the cc-Link system master local unit user's manual (volume on details)" for the details of the parameter setup which uses GX Developer.

- (1) Connect the MELSEC sequencer with the personal computer by the USB cable, the RS-232C cable, etc.
- (2) Start GX Developer
- (3) Select [on-line]-[PC read-out] from the menu, select the kind of connected cable, and read the parameter and the program on GX Developer.
- (4) Select the [parameter] icon in the left frame of GX Developer, and double-click the [network parameter].

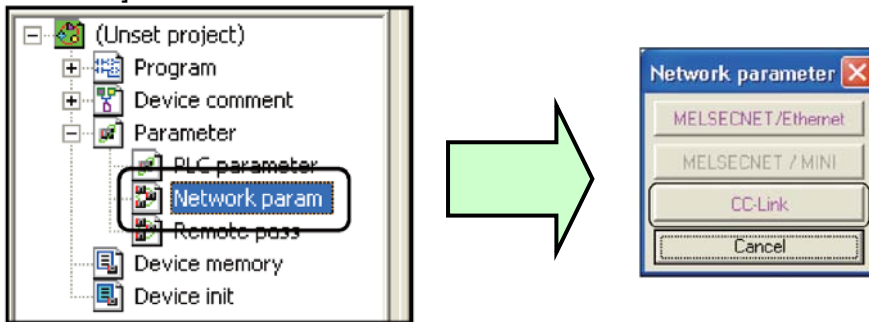

- (5) Click the [CC-Link] button on the displayed "network parameter selection" screen.
- (6) Set up the following on the displayed "network parameter setting" screen.

No.	Item	Details	Initial value	Setting example
1	Head I/O No.	The CC-Link master station specifies the head I/O number of the unit which shows the mounting position on the base board of the MELSEC sequencer.	Blank	0060
2	Number of connection (Range: 1-64)	Set up all the number of connection of the slave station connected on the CC-Link network.	64	1
3	Remote input/output	Set up the device for refreshment of data communications with slave station.	Blank	X1000 Y1000
4	Remote register		Blank	W0 W1000
5	Station information	Set up the type of remote station and local station which connected.	Button	Refer to the following page

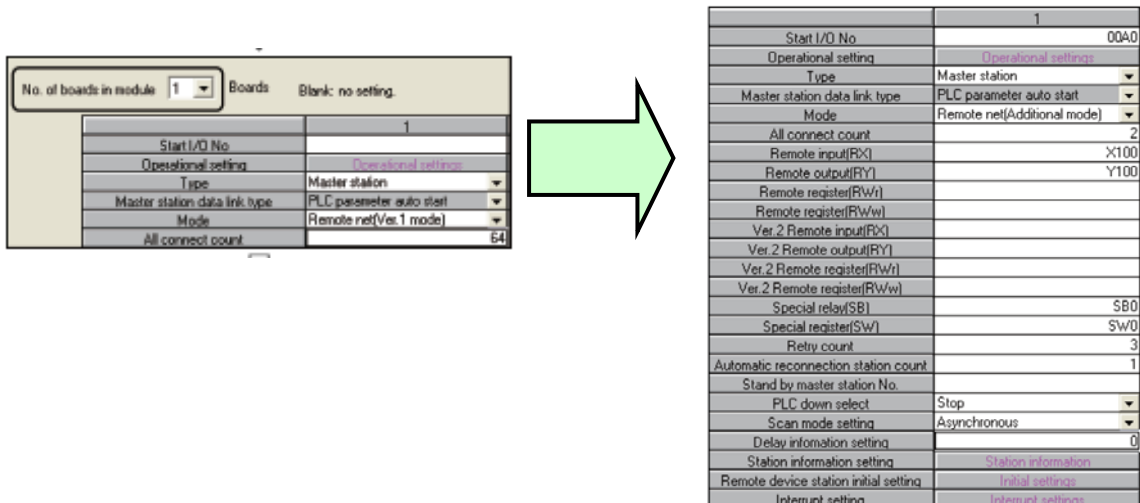

(7) Click the "Station information" button and set up the slave station.

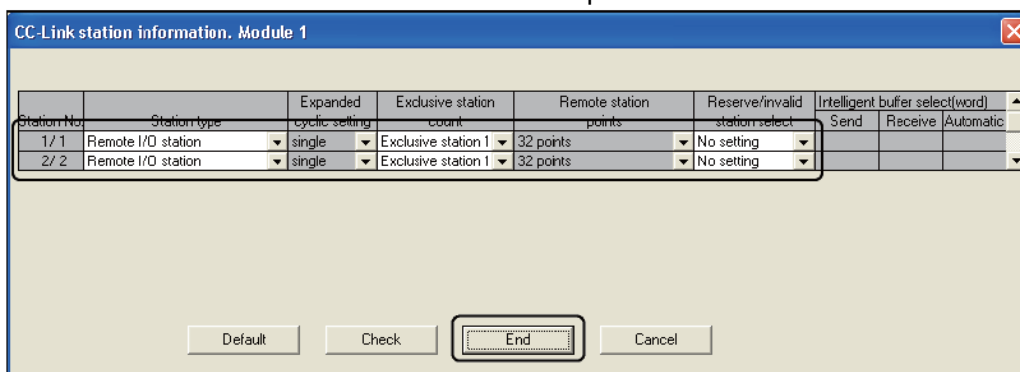

No.	Item	Details	Initial value	Setting example
1	Station classification Ver.1 remote I/O station Ver.1 remote device station Ver.1 intelligent device station Ver.2 remote device station Ver.2 intelligent device station	The robot's CC-Link interface card specifies the "Ver.2 intelligent device station." In case of the 2nd switch (cc-Link version) of DIP switch SW1 on the CC-Link interface card is turned "OFF", specify the "Ver.1 intelligent device station."	Ver.1 remote I/O station	Ver.2 intelligent device station
2	Extended cyclic setup 1 fold setup 2 fold setup 4 fold setup 8 fold setup	Since the CC-Link version is "Ver.2" in initial setting, the multiple setup is possible. By changing the multiple setup, it is possible to increase the point of remote I/O which can communicate, and the register.	1 fold setup	1 fold setup
3	Number of occupancy stations One-station occupancy Two-station occupancy Three-station occupancy Four-station occupancy	Specify the number of the stations which the slave station occupies. The a maximum of four stations can be occupied.	One-station occupancy	One-station occupancy
4	Reservation / invalid station specification With no setup Reservation station Invalid station	In case of the slave station has connected on the CC-Link network, select the "No setup." In the future, the "reservation station" will be specified about the slave station which is due to be connected (extension). And, the slave station which the error does not detect at the time of error occurrence specifies the "invalid station."	With no setup	With no setup

(8) If all are set up, confirm that no error by click [error-checking] button.

(9) Click the [finishing of the setting] button, and click the [finishing of setting] button on the "network parameter setting screen."

(10) Click [on-line]-[PC write-in] from the menu of GX Developer, and write the parameter in the MELSEC sequencer.

In addition, please refer to "the parameter setup by GX Developer" of "the cc-Link system master local unit user's manual (volume on details)" for the details about the setup.

7.2. Set the parameter of the robot controller

Explain the setting method of the special I/O parameter required to execute the sample rudder program shown in appendix, and operate the CC-Link interface card.

Please refer to separate manual "Detailed description of the function and operation" for details of the robot controller parameter.

7.2.1. Setup of parameter about CC-Link interface card

To operate the CC-Link interface card, set the parameter shown below. Make the station number, the number of occupancy stations, the extended cyclic setup, etc. the same as the setup of the slave station.

Table 7.2-1 Parameter for CC-Link interface cards

Parameter name	Function	Setting value
CCINFO	Set up the station number of CC-Link, the number of occupancy stations, and the extended cyclic setup. (Element 1 = station number : 1 to 64) (Element 2 = number of occupancy stations : 1 to 4) (Element 3 = extended cyclic setup : 1, 2, 4, or 8)	1 , 1 , 1
CCSPD	Set the transmission speed of CC-Link. (0: 156k / 1: 625k / 2: 2.5M / 3: 5M / 4: 10M)	4 (*1)
CCFIX	Set up whether the CC-Link signal number is fixed or not. 0: Use the signal number of the specified station number. (Ex.) Set the station number as 3. I/O signal number = from No. 6064 / Register number = from No. 6008 1: Use the signal number from No. 6000 regardless of the station number. (Ex.) Set the station number as 3. I/O signal number = from No. 6000 / Register number = from No. 6000.	1 (*2)

(*1) It is the setting value assumed to have set the [MODE] setup (rotary switch) of the master-station unit to "4."

(*2) In case of the system changed into this interface card, from the previous CC-Link interface card (HR575), it becomes compatibility by setting it as "0."

7.2.2. Setup of special I/O parameter

To execute in the appendix sample rudder program, so the MELSEC sequencer control the robot controller, set up the special I/O parameter as shown below. After the setup turn off the power supply once of robot controller, because of to enable the parameter.

Table 7.2-2 Special I/O parameter

Parameter name	Item	Setting value	Name	Details
IOENA	Input	6000	Operation rights input signal	Sets the validity of the operation rights for the external signal control.
	Output	6000	Operation rights output signal	Outputs the operation rights valid state for the external signal
ATEXTMD	Output	6001	Remote mode output	This output indicates that the key switch on the operation panel is set to AUTO (Ext.), which is a remote operation mode.
SRVON	Input	6002	Servo ON input signal	This input turns ON the servo power supply for the robot.
	Output	6002	In servo ON output signal	This output turns ON when the servo power supply for the robot is ON.
SLOTINIT	Input	6003	Program reset	This input cancels the paused status of the program and brings the executing line to the top. Executing a program reset makes it possible to select a program.
	Output	6003	Program selection enabled output	Outputs that in the program selection enabled state.
PRGOUT	Input	6004	Program No. output request	The program number for task slot 1 is output to the numerical output (IODATA).
	Output	6004	Program No. output signal	The "program number output in progress" status is output to the numerical output.
PRGSEL	Input	6005	Program selection input signal	Designates the setting value for the program No. with numeric value input signals.
START	Input	6006	Start input	This input starts a program.
	Output	6006	Operating output	This output indicates that a program is being executed.
ERRRESET	Input	6007	Error reset input signal	Releases the error state.
	Output	6007	Error occurring output signal	Outputs that an error has occurred.
STOP2 (*1)	Input	6008	Stop input	This input stops the program being executed.
	Output	6008	Pausing output	This output indicates that the program is paused.
SRVOFF	Input	6009	Servo OFF input signal	This input turns OFF the servo power supply for the robot.
	Output	6009	Servo ON disable output signal	This output indicates a status where the servo power supply cannot be turned ON.
DIODATA (*2)	Input Register	6000	Numeric value input	The specified numeric values are loaded.
	Output Register	6000	Numeric value output	The numeric values of the specified items are output.

(*1) The Skip input No. 0 is being fixed to the remote input No. 0. Therefore use the parameter "STOP2" for stop input signal of CC-Link

(*2) In CC-Link, it is possible to specify the program number and the OVRD value with the parameter "DIODATA" (the register input, the register output).

In the rising edge of the signal assigned to the parameter "PRGSEL" or "OVRDSEL", the numerical value of the input register is set as the "program number" and the "OVRD value." However, in case of the parameter "IODATA" is set, be careful the higher priority is IODATA. And, the "program number" and the "error number" are outputted to the specified output register in the rising edge of the signal assigned to the parameter "PRGOUT", "ERROUT", etc. In case of the parameter "IODATA" is set, it is outputted also to the specified signal number.

7.3. Creating a Master Station CC-Link Program

This section describes the procedure for creating a program that allows the CC-Link master station module to communicate using a one-to-one connection with the CC-Link interface card of the robot.

7.3.1. Signal map of master station and robot

With the specified station number or setting values of the parameter "CCFIX", the refreshment device of the signal number and the master station used by the robot program changes. Here, the signal map in the one station, the one-station occupancy, and the 1 fold setup which were set up in Chapter 7.1 is shown in "Table 7.3-1".

Please refer to chapter 7.6 Example of change of system configuration for changing the station number, the number of occupancy stations, the extended cyclic setup, etc.

Table 7.3-1 Signal allocation map of the master station and the robot (remote signal)

Station number	Master station	□	Robot	Robot	□	Master station
	Refreshment device		Input	Output		Refreshment device
0 (master)	-		-	-		-
1	Y1000 ~ Y100F	□	6000 ~ 6015	6000 ~ 6015	□	X1000 ~ X100F
	Y1010 ~ Y101F		6016 ~ 6031	6016 ~ 6031		X1010 ~ X101F



Cautions

The last two points of the remote signal cannot be used.

With the specification of CC-Link, it becomes impossible to use the two last of the remote signal which the robot controller occupies. For example, in case of station-number of the robot controller is set as 1 and one occupancy and the 1 fold setup, the point of the remote signal which can be used is the 32 points, but please keep in mind that the point which can actually be used becomes the 30 points (from No. 6000 to No. 6029) since the two tail ends cannot use it.

Table 7.3-2 Signal allocation map of the master station and the robot (register)

Station number	Master station	□	Robot	Robot	□	Master station
	Refreshment device		Input	Output		Refreshment device
0 (master)	-		-	-		-
1	W1000 ~ W1003	□	6000 ~ 6003	6000 ~ 6003	□	W0 ~ W3

7.3.2. Installation of sample rudder program

Install in the MELSEC sequencer the sample rudder program attached to the appendix. The installation method is shown in the following.

Please refer to "the cc-Link system master local unit user's manual (volume on details)" for the details of the rudder program.

- (1) Create the circuit of the sample rudder program in GX Developer.
- (2) Click [on-line]-[PC write-in] from the menu, select the "program" and click [execution] button.

7.3.3. Flow chart of sample rudder program

The flow chart explains the details of processing of the sample rudder program attached to the appendix.

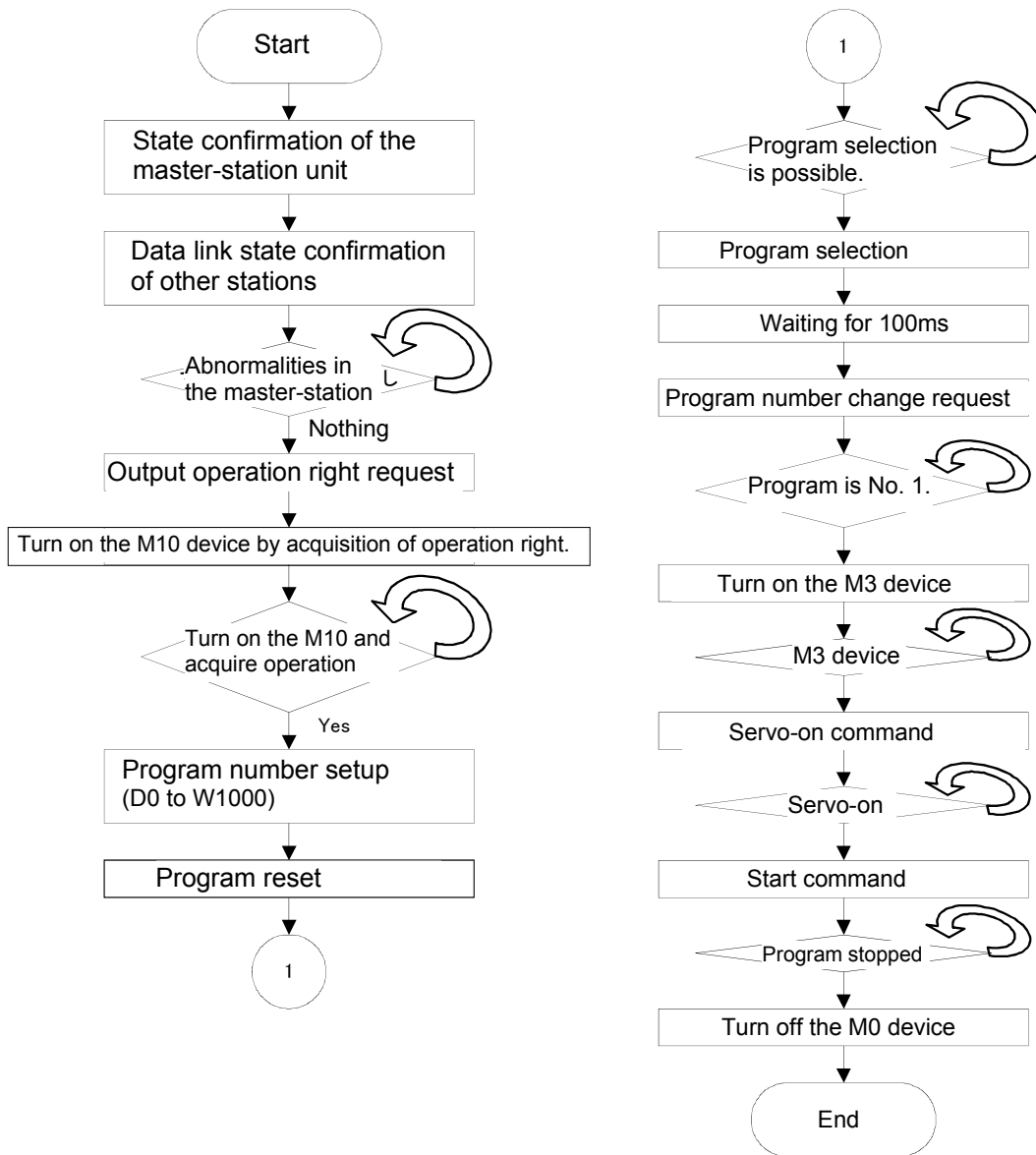

7.4. Create the robot program No. 1

Use RT ToolBox2 (personal computer support software) or the teaching pendant, and create the robot program No. 1.

Refer to separate manual "Detailed description of the function and operation" for the creation method.

The simple example of the program shown in the following

Mov PHOME	' Move to the safety point.
Dly 1	' Wait for the 1 second
Mov P1,-100	' Approach with 100mm to P1
M_Out(6016)=1	' Turn on the output signal No. 6016
Cnt 1,0,0	' Continuation trajectory operation
Mov P1	' Move to P1
M_Out(6017)=1	' Turn on the output signal No. 6017
HClose 1	' Hold the work
Dly 0.5	" Wait for the 1 second
M_Out(6018)=1	' Turn on the output signal No. 6018
Cnt 1	' Continuation trajectory operation
Mov P1,-100	' Approach with 100mm to P100
M_Out(6019)=1	' Turn on the signal for confirmation of move to P2
Mov PHOME	' Move to the safety point
M_DOut(6000)=123	' Output to the register
Hlt	' Program stop
End	' End of the program

This example of the robot program is the example which outputs No. 6019 from the output signal No. 6016 for each operation, and finally outputs "+123" to the output register.

7.5. Start the robot program No. 1 from the master station

Start the robot program No. 1 by the circuit of the sample rudder program.

The procedure is shown in the following.

- (1) Turn on the power supply of the MELSEC sequencer and the robot controller.
- (2) If the key switch in the operation panel of the robot controller is changed to "Automatic", the robot program No. 1 will start automatically.
- (3) If the last of the robot program No. 1 has the "Hlt" command, the robot program will stop automatically.
- (4) If the key switch of the operation panel is changed to "Automatic"->"Manual"-> "Automatic", the robot program No. 1 will be started again.



Cautions

The program is executed when the key switch is changed to "Automatic."

The sample rudder program is programmed to start the robot program No. 1, if the key switch in the operation panel of the robot controller is set to "Automatic."

Fully confirm that neither the interference object nor the worker is in the robot's circumference before changing the key switch to "Automatic."

7.6. Example of change of system configuration

Explain the details which change the system configuration into two or more connection of slave stations from 1 to 1 connection.

7.6.1. Add the 2nd robot controller

The procedure of setup of when adding one robot controller to the master station and one robot controller system is shown in the following.

Table 7.6-1 The CC-Link setting conditions of two robot controllers

Robot controller	Station type	Station number	Number of occupancy	Extended cyclic setup	Reservation / invalid station
1st station	Ver.2 intelligent device station	1	1	1	No setup
2nd station	Ver.2 intelligent device station	2	2	4	No setup

(1) Change the network parameter of the MELSEC sequencer

a) Change the number of connection from "1" to "2"

The screenshot shows the 'Network parameter' window. On the left, the 'All connect count' is set to 1. A green arrow points to the right, where the 'All connect count' is set to 2, and this row is highlighted with a red box. Other parameters like 'Start I/O No' (0060), 'Type' (Master station), and 'Mode' (Remote net(Ver.2 mode)) remain unchanged.

b) Click the [Station information] button, and set up the conditions of the slave station.

Station No.	Station type	Expanded cyclic setting	Exclusive station count	Remote station points	Reserve/invalid station select	Intelligent buffer select(word)		
						Send	Receive	Automatic
1/1	Ver.2Intelligent device station	single	Exclusive station 1	32 points	No setting	64	64	128
2/2	Ver.1Remote I/O station	single	Exclusive station 1	32 points	No setting			

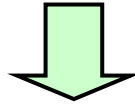

Station No.	Station type	Expanded cyclic setting	Exclusive station count	Remote station points	Reserve/invalid station select	Intelligent buffer select(word)		
						Send	Receive	Automatic
1/1	Ver.2Intelligent device station	single	Exclusive station 1	32 points	No setting	64	64	128
2/2	Ver.2Intelligent device station	quadruple	Exclusive station 2	192 points	No setting	64	64	128

c) Click [on-line]-[PC write-in] from the menu, and write the parameter in the MELSEC sequencer.

(2) Change the parameter of the 2nd robot controller from the initial value.

The screenshot shows the 'Parameter name : CCINFO' window. On the left, the 'Robot#' is 1 and the values for parameters 1, 2, and 3 are all 1. A green arrow points to the right, where the values for parameters 1, 2, and 3 are changed to 2, 2, and 4 respectively.

Click the [Writing] button and turn off the power supply of the robot controller once.

Allocation of the refreshment device of the signal number and master station which are used by the robot program in this system is as follows.

Table 7.6-2 Signal allocation map of the master station and the robot (remote signal)

Station number	Master station	□	Robot	Robot	□	Master station
	Refreshment device		Input	Output		Refreshment device
0 (master)	-		-	-		-
1 (robot 1) 32 point	Y1000 ~ Y100F		6000 ~ 6015	6000 ~ 6015		X1000 ~ X100F
	Y1010 ~ Y101F		6016 ~ 6031	6016 ~ 6031		X1010 ~ X101F
2 (robot 2) 192 point	Y1020 ~ Y102F	□	6000 ~ 6015	6000 ~ 6015	□	X1020 ~ X102F
	Y1030 ~ Y103F		6016 ~ 6031	6016 ~ 6031		X1030 ~ X103F
	Y1040 ~ Y104F		6032 ~ 6047	6032 ~ 6047		X1040 ~ X104F
	Y1050 ~ Y105F		6048 ~ 6063	6048 ~ 6063		X1050 ~ X105F

	Y10C0 ~ Y10CF		6160 ~ 6175	6160 ~ 6175		X10C0 ~ X10CF
	Y10D0 ~ Y10DF		6176 ~ 6191	6176 ~ 6191		X10D0 ~ X10DF

* The last two points cannot use each robot.
 No. 6030 and No. 6031 cannot use the robot 1.
 No. 6190 and No. 6191 cannot use the robot 2

Table 7.6-3 Signal allocation map of the master station and the robot (register)

Station number	Master station	□	Robot	Robot	□	Master station
	Refreshment device		Input	Output		Refreshment device
0 (master)	-		-	-		-
1 (robot 1) 4 point	W1000 ~ W1003		6000 ~ 6003	6000 ~ 6003		W0 ~ W3
2 (robot 2) 32 point	W1004 ~ W1007	□	6000 ~ 6003	6000 ~ 6003	□	W4 ~ W7
	W1008 ~ W100B		6004 ~ 6007	6004 ~ 6007		W8 ~ W0B

	W1020 ~ W1023		6028 ~ 6031	6028 ~ 6031		W20 ~ W23

7.6.2. Add the robot controller to the system which four slave stations are connected.

The procedure of setup of when adding one robot controller to the master station and four slave station system is shown in the following.

Table 7.6-4 CC-Link setting conditions of slave station and robot controller

Robot controller	Station type	Station number	Number of occupancy	Extended cyclic setup	Reservation / invalid station
—	Ver.1 remote I/O station	1	1	1	No setup
—	Ver.1 remote device station	2	2	1	No setup
—	Ver.2 remote device station	4	3	2	No setup
—	Ver.2 intelligent device station	7	4	4	No setup
1st station	Ver.2 intelligent device station	11	3	1	No setup

- (1) Change the network parameter of the MELSEC sequencer
 - a) Change the number of connection from "4" to "5"

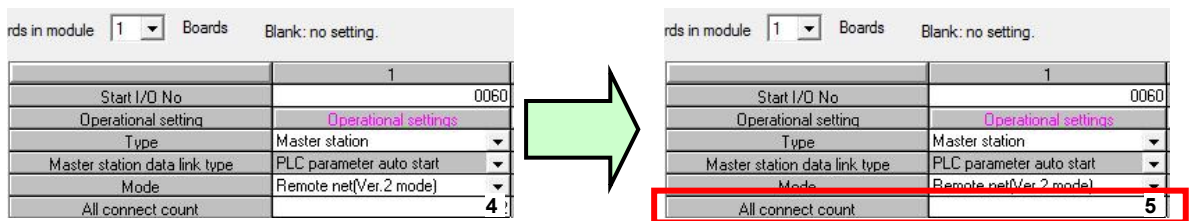

- b) Click the [Station information] button, and set up the conditions of the slave station.

The image shows two screenshots of the 'Station information' table. The top screenshot shows the initial configuration with 4 stations. A green arrow points to the bottom screenshot, where a new station (5/11) has been added and is highlighted with a red box.

Station No.	Station type	Expanded cyclic setting	Exclusive station count	Remote station points	Reserve/invalid station select	Intelligent buffer select(word)		
						Send	Receive	Automatic
1/1	Ver.1Remote I/O station	single	Exclusive station 1	32 points	No setting			
2/2	Ver.1Remote device station	single	Exclusive station 2	64 points	No setting			
3/4	Ver.2Remote device station	double	Exclusive station 3	160 points	No setting			
4/7	Ver.2Intelligent device station	quadruple	Exclusive station 4	448 points	No setting	64	64	128
5/11	Ver.2Intelligent device station	single	Exclusive station 3	96 points	No setting	64	64	128

- c) Click [on-line]-[PC write-in] from the menu, and write the parameter in the MELSEC sequencer.

- (3) Change the parameter of the robot controller from the initial value.

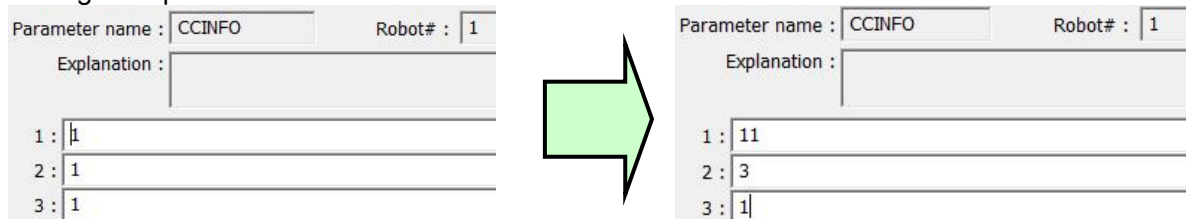

Click the [Writing] button and turn off the power supply of the robot controller once.

Allocation of the refreshment device of the signal number and master station which are used by the robot program in this system is as follows.

Table 7.6-5 Signal allocation map of the master station and the robot (remote signal)

Station number	Master station	□	Robot	Robot	□	Master station
	Refreshment device		Input	Output		Refreshment device
0 (master)	-		-	-		-
1	-		-	-		-
2	-		-	-		-
4	-		-	-		-
7	-		-	-		-
11 (robot 1) 96 point	Y12C0 ~ Y12CF	□	6000 ~ 6015	6000 ~ 6015	□	X12C0 ~ X12CF
	Y12D0 ~ Y12DF		6016 ~ 6031	6016 ~ 6031		X12D0 ~ X12DF
	Y12E0 ~ Y12EF		6032 ~ 6047	6032 ~ 6047		X12E0 ~ X12EF
	Y12F0 ~ Y12FF		6048 ~ 6063	6048 ~ 6063		X12F0 ~ X12FF

	Y1300 ~ Y130F		6064 ~ 6079	6064 ~ 6079		X1300 ~ X130F
Y1310 ~ Y131F	6080 ~ 6095	6080 ~ 6095	X1310 ~ X131F			

* The last two points cannot use each robot.
No. 6094 and No. 6095 cannot use the robot.

Table 7.6-6 Signal allocation map of the master station and the robot (register)

Station number	Master station	□	Robot	Robot	□	Master station
	Refreshment device		Input	Output		Refreshment device
0 (master)	-		-	-		-
1	-		-	-		-
2	-		-	-		-
4	-		-	-		-
7	-		-	-		-
11 (robot 1) 12 point	W1060 ~ W1063	□	6000 ~ 6003	6000 ~ 6003	□	W60 ~ W63
	W1064 ~ W1067		6004 ~ 6007	6004 ~ 6007		W64 ~ W67

	W1068 ~ W106B		6008 ~ 6011	6008 ~ 6011		W68 ~ W6B

8. Troubleshooting

Please read this chapter first if you suspect that some failure has occurred.

8.1. List of Errors

Table 8.1-1 List of Errors

Error No.	Error message	Cause	Action
7700	CC-Link card is illegal (Error Code).	CC-Link card is illegal.	Please exchange the CC-Link card.
7710	Cannot set a CC-Link master station.	A master station is already set by the rotary switch.	Set the rotary switch to other than 0.
7720	Two CC-Link interface cards are mounted.	Mount one card in slot 2.	It is not allowed to install two cards. Install only one card.
7730	CC-Link data link error (local station connection error)	There is a line error or the master station's parameter settings are invalid.	Review the line and parameters (see Section 8.2).
7750	A (CC-Link) cable is not connected or parameters do not match.	A cable is not connected or parameters do not match.	Reset the power and start again.
7760	CC-Link initialization error	The master station's parameters do not match.	Correct the parameters, and then start again.
7780	A CC-Link register number is outside the range.	A register number entered is outside the allowable range.	Enter the correct value.
7781	A signal number for CC-Link was specified.	A signal number for CC-Link was specified.	Install a CC-Link interface card.

*Refer to "the cc-Link system master local unit user's manual (volume on details)" for the details of the CC-Link error code.

Refer to 8.3 When 7760 errors (abnormalities in cc-Link initialization) occur for the error which is not indicated to the error code of the above-mentioned manual.

8.2. An E7730 Error Has Occurred and CC-Link does not Establish a Link

Please confirm the next item, when you cannot solve, even if measures.

- 1) Are the setup of rotary switch (MODE) on the CC-Link master-station unit and the setup of the parameter "CCSPD" in agreement?
- 2) Is the terminator connected?
- 3) Is the CC-Link communication cable equipped with the ferrite core at the place of many noises ?
- 4) The check of the status confirmation by LED, the short circuit of the CC-Link unit by the tester, etc. is possible. Please refer to "open field network CC-Link troubleshooting guidance" for the check method.

8.3. When 7760 errors (abnormalities in cc-Link initialization) occur

Please confirm the next item, when you cannot solve, even if measures.

Please refer to the following table, in case of there is no error code shown in the tail end of the error message in the parenthesis in "the cc-Link system master local unit user's manual (volume on details)."

Table 8.3-1 Error code of abnormalities at CC-Link initialization

Error code	Details of the error	Cause and measures
D010	Initial signal timeout	The error in communication with the robot controller and the CC-Link interface card. Since the circuit on the CC-Link interface card or the connector section of the option slot has possibilities, such as damage and the short circuit, please ask the maker.
D020	Abnormalities in the sum check of the TZ576 card	
D030	Abnormalities in the sum check of system construction	
D040	Abnormalities in the reversal sum check of system construction	
D050	Timeout of existence confirmation	
B9FF	Abnormalities in the handshake with the TZ576 card	

9. Appendix

9.1. Sample Ladder Program

The example of the sample rudder program for Q series sequencers of MELSEC is shown below. This sample rudder program is programmed to operate program No. 1 automatically, if the mode of the controller is changed to "Automatic".

