



ES52

Auto Start Engine Controller

Installation and User Manual for the ES52 Auto Start Engine Controller.

Full Version

File: ES52rev2.63.doc
October 24, 2006

Thank You For Purchasing This DynaGen Product

Please Read Manual Before Installing Unit

Receipt of Shipment and Warranty Return Information

Upon receipt of shipment, carefully remove the unit from the shipping container and thoroughly examine the unit for shipping damage. In case of damage, immediately contact the carrier and request that an inspection report be filed prior to contacting DynaGen.

All returned items are to be shipped prepaid and include a Return Material Authorization (RMA) number issued by DynaGen. RMA forms are available by contacting DynaGen Technical Support through the contact methods listed below.

Limited Warranty

DynaGen will repair or replace any ES52 controller which proves to be defective under normal and proper use within **Three Years** from the date of shipment. This constitutes the only warranty and no other warranty shall be implied.

We welcome your comments and suggestions. Please contact us at:

DynaGen Technologies Inc.
Phone: 1-888-396-2436
(902) 562 0133
Fax: (902) 567 0633
Email: support@dynagen.ca
WEB SITE: www.dynagen.ca

Table of Contents

INTRODUCTION	4
SPECIFICATIONS	5
WIRING INSTALLATION GUIDELINES	6
Wiring instructions, types and sizes	6
Wiring guidelines	7
Terminal description	8
General Wiring Diagram	10
Outline Dimension Drawing	11
ADJUSTMENTS AND SETUP PROCEDURES	12
Select the engine speed range	13
<u>Oil switch verification</u> - oil switch enabled or disabled	13
Select a timer function	14
Adjusting <u>Timer</u> setting	15
Setup Mode Calibration	15
<u>Crank/Rest time</u> calibration	16
<u>Crank Disconnect</u> calibration	16
<u>Over-speed</u> calibration	17
Select the maximum number of <u>Crank Tries</u>	17
Warmup	17
LED INDICATIONS	18
TROUBLESHOOTING GUIDELINES	19

INTRODUCTION

The ES52 provides automatic start/stop and protection control for all types of engine-driven equipment. Simplicity of use, safety, features, versatility and over-all quality are paramount, providing the most cost-effective and reliable solution available. Ours came to be one of the smallest controllers available, with the best value per dollar-cost, backed by a 3 year warranty.

The ES52 maintains backward compatibility to the extent that it can replace similar products without substantial rewiring. Functionally, however, it is loaded with unique features:

- "No speed signal" detection: Should the frequency of the speed sensing signal go to zero while the engine is running, or fail to appear during cranking, a No Speed Failure is asserted, and specifically indicated. **NOTE**: Speed signal detection during cranking can be disabled via an on board jumper. In some cases when using generator mains as speed signal source it is require to disable this shutdown (when residual is very low).
- Differential speed sensing inputs (for twisted-pair connection): Very effective interference prevention by means of noise cancellation.
- Excellent EMI handling: Software detection of, and recovery from, noise corruption.
- REPLACEABLE RELAYS; Replaceable relays provided within on board sockets. Relays Rated 20 Amps at 30 VDC
- REPLACEABLE FUSE; On board replaceable 20A fuse, mini-fuse (standard automotive type).
- Reversed supply protection; No requirement for series diode on supply.
- 3.3V to 30V, -40°C. to +85°C. operation: Works anywhere, anytime.
- Zero Speed Restart™ : Prevents starter pinion wear by ensuring that no engagement of the starter is possible unless the speed is zero.
- Oil Bypass Failure: Waits 15 seconds from start for 1-3 crank tries, and 20 seconds for more than 3 crank tries, before enabling Low Oil pressure monitoring. Requires no user setting.
- Four Timer Functions : Glow Plug, *Smart Choke™* , Air-Gate and Slow.
- Rest-Time indication: Provides feedback between crank attempts.
- WARMUP: Turns an output on, which can control a load device. Warmup timer output is provided on all ES52 units via terminal 19. Warmup timer is a fixed 2 minutes.
- SMALL SIZE; 3.302" x 3.342" x 1.842" 0.67lbs

SPECIFICATIONS

Operating VDC limits:	(3.3VDC min.- 30VDC max.) Provided minimum 8VDC Present at Starting.
Standby current draw:	12.2mA at 12VDC (12.4mA at 24VDC)
Operating current draw:	140mA at 12VDC (80mA at 24VDC)
Reverse polarity protected:	Internal protection will prevent damage to unit under a reverse polarity condition. Re-connect power leads properly, and normal operation will resume.
Speed sensing input accepts:	Generator AC output directly
Speed sensing maximum rating:	Withstands Line voltage (300 V.A.C.)
Operating temperature range:	-40 ^o C ⇒ +85 ^o C
Operating humidity range:	0 ⇒ 95% non-condensing
Fuel & Crank contact output:	10 Amps max. each, continuous sourcing(+bat) output
Annunciation outputs:	Sourcing (+bat) outputs (300ma max. per output)
Lamp Test terminal:	Close to + Battery to test LEDs
Actual unit weight:	0.67 lb. (0.30kg)
Shipping weight:	1 lb. (0.45kg)
Unit dimensions:	3.302" x 3.342" x 1.8"
Shipping dimensions:	4" (10.16cm) x 4" (10.16cm) x 3" (7.62cm)

WIRING INSTALLATION GUIDELINES

Danger: Never work on the engine while its power is on. This controller does not generate a warning signal prior to automatic engine start. Warning signs should be placed on engine equipment indicating this important safety measure.

INSTRUCTIONS

Following these instructions will help avoid common installation problems during wiring and setup.

- Battery must be disconnected before any wiring connections are made.
- Wire length from the engine to the controller should not exceed 6 meters (20 feet).

Wiring size and type should be as specified below. **Use stranded wire**, since solid wire has a tendency to crack, break and loosen over time.

TYPES AND SIZES

Terminal	Wire Size	Current max.	Function
CON 1	Harness Supplied	100mA	Speed signal connection via on board connector
1	18	100mA	LED Test Switch
2	18	7mA	Oil Pressure Switch
3	18	7mA	High Temperature Switch
4	18	7mA	Auxiliary Input Switch
5	14	10 A	Starter Solenoid/Pilot Relay
6	12	20 A	Battery negative (-)
7	12	20 A	Auto Switch
8	12	20 A	RSC1 (remote start contact connection)
9	12	20 A	RSC2 (remote start contact connection)
10	12	20 A	Start/Stop Connection
11	14	10 A	Fuel Solenoid/Pilot Relay
12	18	300mA	Timer Output
13 ⇒ 18	18	300mA	Annunciation Outputs
19	18	300mA	Warmup Output
20	18	300mA	<u>Annunciator Common Ground Only</u> (DO NOT use this as main ground connection)

WIRING GUIDELINES

1. DO NOT use wire smaller than 18 AWG.
2. The connections supplying DC power to the ES52 panel should preferably run directly from the battery posts with no splices or other connections except a 25A fuse connecting the positive line directly to the +Battery terminal. Avoid, as much as possible, using chassis (aluminum or iron engine parts) as return conductor for battery negative voltage; copper wiring is recommended. Failure to follow the above may result in erratic operation, due to large voltage drops across wiring connections.
3. DO NOT short Crank output or Fuel outputs to ground, as this will cause on board 20Amp fuse to blow and may result in damage to the ES52'S onboard relays.
4. When replacing fuse, removable terminals and relays, only use factory recommended parts.
5. DO NOT use AC coil slave relays from controller outputs. Use intermediate relays of suitable size and coil rating.
NOTE: All ES52 engine controllers are shipped standard with 12VDC coil relays for +12 VDC systems. If the engine controller is used in a +24 VDC system, the onboard relays MUST be replaced with 24VDC coil relays.
6. DO NOT exceed the maximum rated current and voltage on each of the controller outputs. Do not exceed 10 amps for the Fuel output and 10 amps for the Crank output, and 300ma for the annunciation and timer outputs.
7. The annunciation and timer outputs are internally protected against overload and short circuit (fault) NOTE: When a fault appears on one of the annunciation outputs, only that specific output becomes un-operable, all other annunciation outputs and all the front panel LED's continue to operate. When fault is removed, the unit is restarted, and the output resumes proper operation.
8. Two wires must be connected for the speed signal NOTE: A mating connector complete with 8 feet of cabling is provided as standard with each unit.
9. Diodes are provided across Fuel, Crank, and annunciation outputs, to protect the outputs from inductive kick-back. Diodes should be placed across slave relay contacts when used to actuate any inductive loads, such as solenoids, to protect the contacts from damage caused by arcing. In addition to prolonging the useful life of the relays, placing such diodes will help reduce generated electrical noise.
10. To verify the operation of engine controller outputs, measure voltage (i.e. meter in volts) when outputs should be ON.

TERMINAL DESCRIPTION

Term #	Description
CON1	Speed signal input for crank disconnect, engine run, and over-speed sensing. Be sure to use twisted pair wiring for this connection. An 8-foot wiring harness is supplied as standard. 300 VAC max. input voltage.
1	Lamp test. Connecting +12/24 VDC to lamp test activates all of the front panel LED's. NOTE: <i>Annunciation outputs DO NOT activate under led test.</i>
2	Oil pressure switch. For proper operation, oil input must be connected to ground or +12/24 VDC via an oil switch. This switch must be the N.O. type, close on failure (low pressure)
3	Temperature switch. For proper operation, temperature input must be connected to ground or +12/24 VDC via a temperature switch. This switch must be the N.O. type, close on failure (high temperature).
4	The Auxiliary input. For proper operation, Aux. Input must be connected to ground or +12/24 VDC via a sensor switch. This switch must be the N.O. type, close on failure.
5	Crank output provides 10A maximum. Crank output closes to +12/24 VDC during cranking, and opens when the engine has started, or during crank rest.
6	Battery ground connection for the controller module. A good ground connection, directly from the battery , is required for proper operation.
7	Auto terminal. When +12/24 VDC is applied; the controller is in the standby mode waiting for a Start/Stop signal (+12/24 VDC applied to Start/Stop).
8	RSC1, provided for the connection of one lead from the remote start contacts
9	RSC2, provided for the connection of other lead from the remote start contacts
10	(Start/Stop) terminal. When +12/24 VDC is applied, the controller proceeds to starting the engine.
11	Fuel output provides 10A maximum. Fuel output closes to +12/24 VDC when start signal is actuated, and opens when either an Engine failure is detected or when stop signal is applied.
12	The Timer output provides 300mA maximum. This output has one of four possible functions (Glow Plug, Slow, Air-gate, Choke). This output closes to +12/24 VDC when activated.
13	Low Oil pressure output provides 300mA maximum. Oil output closes to +12/24 VDC when the engine shuts down due to a Low Oil pressure condition. Flashing Low Oil output indicates an Auxiliary Input failure.
14	High water temperature output provides 300mA maximum. Temperature output closes to +12/24 VDC when the engine shuts down due to a high temp condition.
15	Over-crank output provides 300mA maximum. Over-crank output closes to +12/24 VDC when the engine shuts down due to an Over-crank failure.
16	Over-speed output provides 300mA maximum. Over-speed output closes to +12/24 VDC on an Over-speed failure and is open otherwise. Flashing output indicates Loss of Speed Signal.
17	Engine running output provides 300mA maximum. Engine Running output closes to +12/24 VDC when the engine starts (speed > crank disconnect setting), and opens when the engine stops. Flashing output indicates Crank Rest period.

18	Engine failure output provides 300mA maximum. Engine failure output activates on any failure (closes to +12/24 VDC when activated).
19	Warmup output provides 300mA protection. Output turns on after controller has been running for 2 minutes and 10 seconds.
20	Common ground -for annunciation outputs only. DO NOT USE AS MAIN GROUND TO CONTROLLER UNIT.

General Wiring Diagram

ATTENTION

All ES52 Controllers come with 12VDC Relays for 12V systems.
For 24V systems replace with 24VDC Relays.

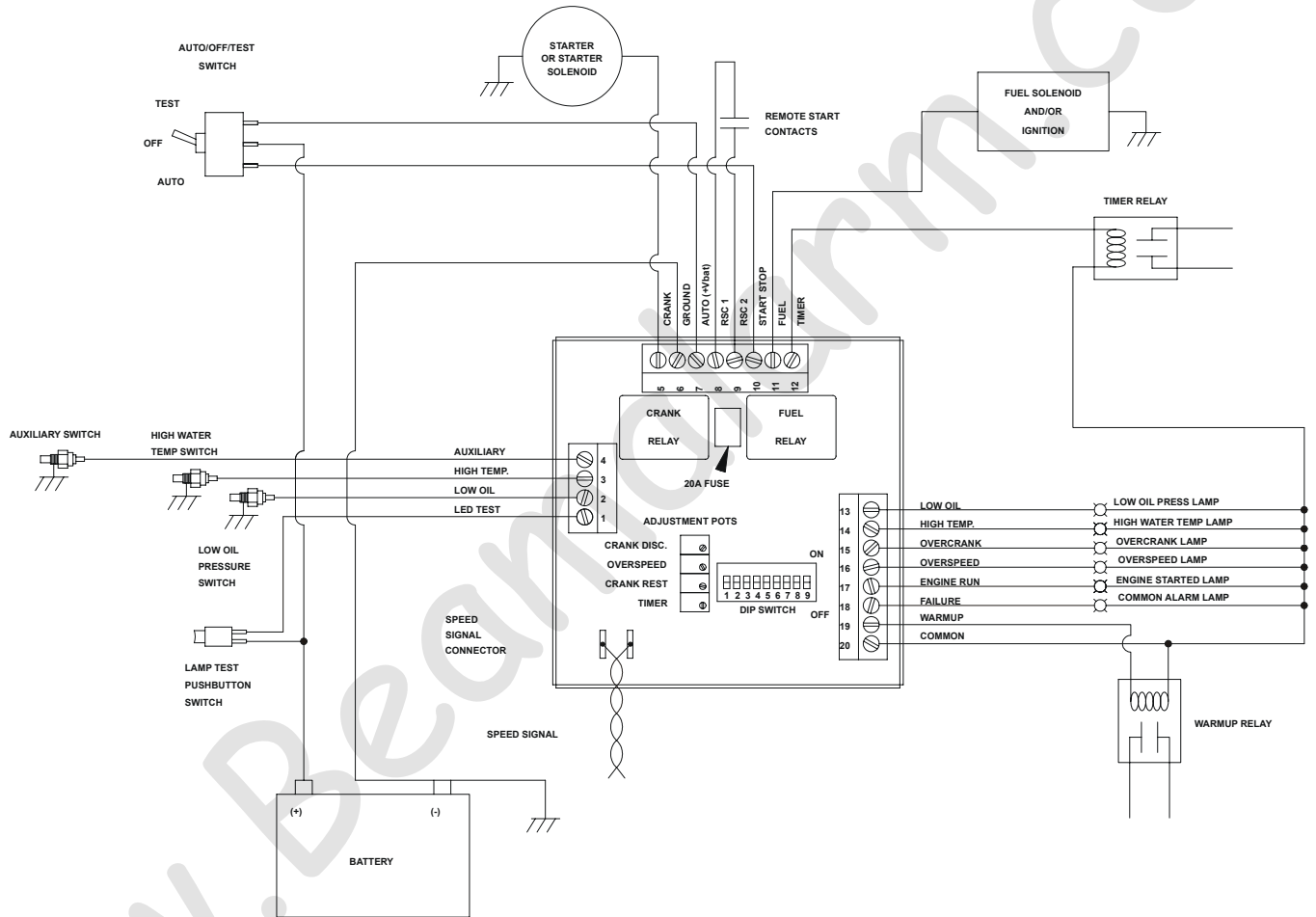

ES52 GENERAL WIRING DIAGRAM

ES52 Outline Dimensions

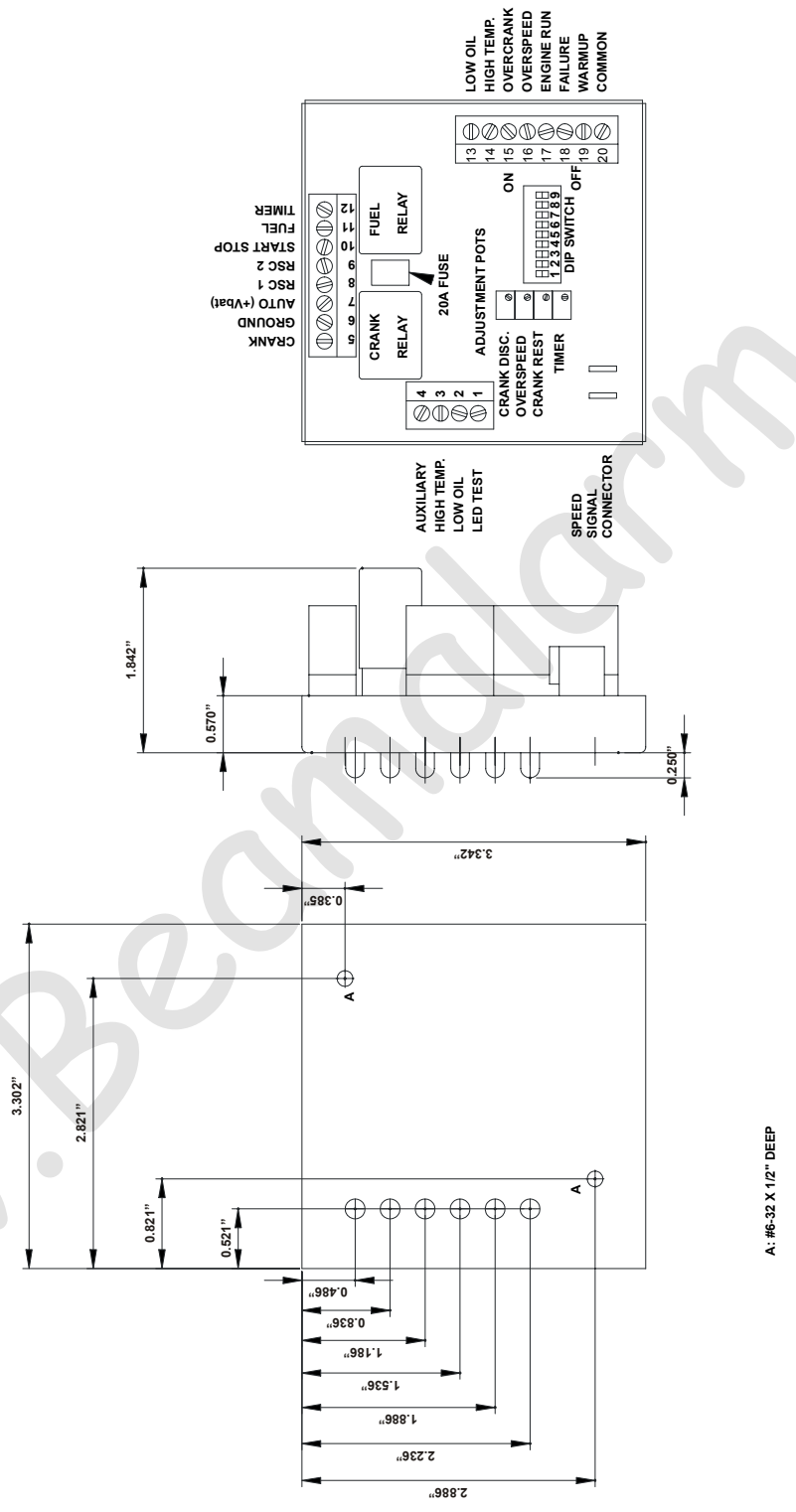

A: #6-32 X 1/2" DEEP

ADJUSTMENTS AND SETUP PROCEDURES





Warning: The following procedures will require engine operation. Be sure to follow all safety guidelines and wiring procedures.

NOTE:

“Potentiometer” is abbreviated as “pot” throughout. To increase a pot’s setting, turn it clockwise; to decrease it, counter-clockwise. On board Pots are 20 turns nominal, therefore turn pots fully 20 turns to ensure that you are at either the minimum or maximum setting. The rear of the ES52 controller contains four adjustable pots, and nine DIP switches.

"Oil BypassTM" period refers to the delay period (fixed at 15 seconds for 1-3 crank tries and 20 seconds for more than 3 crank tries) immediately after the Engine Running LED illuminates (Engine starts). During this period the oil input is bypassed (ignored).

Potentiometers are shown below as they appear on the rear of the ES52 series units

1. Crank Disconnect	1 
2. Over-Speed	2 
3. Crank/Rest Time	3 
4. Timer time	4 

CRANK TRIES				SPEED SETTING				TIMER				
S1	S2	S3	#	S4	S5	Range	CRDC	OVSP	S7	S8	Setting	
on	on	on	setup	off	off	lo	12 - 140	44 - 300				
off	on	on	6	on	on	hi	60 - 4156	300 - 8492				
on	off	on	5	CRDC - Crank Disconnect (Hz)					off	off	Glow Plug	
off	off	on	4	OVSP - Overspeed (Hz)					on	off	Airgate	
on	on	off	3	S6 OIL VERIFICATION					off	on	Choke	
off	on	off	2	on Enabled					on	on	Slow	
on	off	off	1	off Disabled					on	on	Slow	
off	off	off	- single crank attempt - 4 to 256 sec									
LOSS OF SPEED WHILE CRANKING				S9 on-Enabled off-Disabled								

Label on Rear of ES52 series units.

The steps for calibration of the ES52 controller to a specific system are as follows:

1. Select the Engine Speed Range (DIP switches 4, 5)
2. Oil Switch Verification - oil switch enabled or disabled (DIP switch 6)
3. Select a Timer function - (DIP switches 7 & 8)
4. Adjusting Timer setting - (Only needed for Slow and Glow Plug functions)
5. Selecting Setup Mode (DIP switches 1, 2 & 3)
6. Crank/rest time calibration
7. Crank Disconnect calibration
8. Over-speed calibration
9. Selecting the maximum number of Crank Tries (DIP switches 1, 2 & 3)

1: SELECTING THE ENGINE SPEED RANGE

Two speed ranges are provided to permit greatest accuracy when adjusting Crank Disconnect and Over-speed settings. The speed ranges are selectable from DIP switches 4 and 5.

Generator output: When using generator output (50 or 60 Hz) speed range 1(LO) is required.

Flywheel Alternator: When using a flywheel alternator speed range 1(LO) will be required. Refer to engine's specification for number of poles attached to flywheel. i.e. 1 pole (60Hz), 2 poles (120 Hz) , & 4 poles (240 Hz).

Engine Alternator: An engine alternator would require speed range 1(LO) or 2(HI). Refer to engine's specification for pulley ratio and number of poles before selecting range.

Magnetic pickup: A magnetic pickup would require speed range 2(HI).

Range	SW 4	SW 5	Crank Disconnect (Hz)	Over-speed (Hz)
1(LO)	OFF	OFF	12 - 140 Hz	44 – 300 Hz
2(HI)	ON	ON	60 - 4156 Hz	300 - 8492 Hz

Selecting the Proper Speed Range

2: OIL SWITCH VERIFICATION

The oil pressure switch must be the type that opens when oil pressure is normal, and closes on Low Oil pressure (failure condition or engine stopped). **DIP switch 6 must be set to the ON position if you wish to enable oil verification, and set to the OFF position if oil verification is to be disabled.** If DIP switch 6 is ON, prior to Cranking, the controller will attempt to verify that the pressure switch is connected and operating properly by checking if the circuit is closed. If the oil pressure switch does not work or the wire fails to make the connection, the engine will be prevented from starting, and the ES52 will assume a 'wait and see' mode (indicated by a steady Low Oil and flashing Engine Running LED). As soon as the oil pressure switch closes, Cranking will proceed as usual. (If the engine starts, the controller will check for a Low Oil failure condition only after the *Oil BypassTM* period). *Notice that if this verification was not performed, a 'bad connection' of the oil switch might go unnoticed until such time as oil runs out, and engine damage occurs!*

Note:

- i) Oil circuit verification is only performed: a) On the first Cranking attempt b) If the engine has been previously running, and more than 5 minutes of rest has elapsed.
- ii) If DIP switch 6 is set to the off position, the ES52 does not provide oil verification. The ES52 goes immediately into cranking; it will then check for a low oil failure condition after the oil bypass period has elapsed.

SW 6	Oil switch verification
ON	Enabled
OFF	Disabled

3: SELECTING A TIMER FUNCTION:

The timer function is configurable from DIP switches 7 & 8. The output terminal associated with this timer setting is terminal #12. It has four configurable functions, of which two are adjustable:

Glow Plug: The Glow Plug timer is **adjustable from 0 - 32 seconds**. Glow Plug is a timing function used with Diesel engines. This output is energized on every Crank attempt for a set time *prior* to Cranking engine.

Choke: The choke function is used on gasoline engines having an electric choke. The choke output is energized 2½ seconds into the cranking cycle, but only on even numbered Crank attempts (Exception; single crank attempt mode allows choke). If engine speed remains above Crank Disconnect setting, Choke output is turned off; but as soon as speed falls below Crank Disconnect, it is re-applied. This ON/OFF regulation will continue, if necessary, as long as the *Oil BypassTM* period is in effect.

Air-gate: The air-gate output is used to control an air damper and only actuates for a **fixed 10 seconds** immediately after an Over-speed Failure occurs. This feature is used for some Diesel engines that cannot be stopped quickly enough by merely shutting off the Fuel in the event of an Over-speed condition. An electrically operated air damper is installed at the air intake, which effectively ‘gags’ the engine to a stop. Refer to engine’s manual for more information.

Slow: This function is **adjustable from 0 - 256 seconds** via the “Timer” pot. The “Timer” output energizes when engine speed goes above Crank Disconnect speed (engine starts), and remains so for the prescribed duration. It is called “Slow” because it would, presumably, be used to tell a *governor* to ‘go slowly’; for such applications as irrigation pumps, where running slowly for the first minute or two prevents ‘water hammer’.

The timer settings are as specified in the following table.

SW 7	SW8	Timer function	Adjustable Time
OFF	OFF	Glow Plug	0 - 32 seconds
ON	OFF	Air-gate	Not Adjustable(10 sec.)
OFF	ON	Choke	Not Adjustable
ON	ON	Slow	0 - 256 seconds

4: ADJUSTING TIMER (Glow Plug and ‘Slow’ only, as Air-gate and Choke do not use pot) (0 - 32 seconds For Glow Plug and 0 - 256 seconds for slow)

For the **Glow Plug setting (DIP switches 7 & 8 off)**:

- a) Remove wires connected to the Timer terminal #12 and Crank terminal # 5.
- b) Apply power to Start/Stop terminal # 10.
- c) Measure the time the “Timer” LED remains ON.
- d) Remove power from Start/Stop terminal # 10.
- e) Increase or decrease pot setting as required. Resolution is 1.6 seconds/turn.
- f) Return to step b.

For the **slow setting (DIP switches 7 & 8 on)**:

- a) Apply power to Start/Stop terminal # 10.
- b) Allow the engine to Crank and start, Engine Running LED turns ON.
- c) The “Timer” LED will illuminate, measure the time that the LED remains ON.
- d) Increase or decrease pot setting as required pot resolution is 12.8 seconds/turn.
- e) Return to step a.

Re-connect wires to the Timer terminal #12 and Crank terminal # 5 before proceeding to Step 5.

5: SETUP MODE CALIBRATION: Setup mode allows for much easier calibration of Over-speed, Crank Disconnect and Crank/Rest time. When the unit is removed from Setup Mode, the Over-speed and Crank-Disconnect pot settings will be increased by 15% of calibrated values. **NOTE:** If setup mode is used skip to page 17

To enter **Setup Mode**: Set DIP switches 1, 2 & 3 to the ON position. During setup mode the following conditions apply:

- Crank time defaults to present potentiometer value. The maximum crank time is 36 seconds.
- Crank/Rest calibration - Apply power to Auto, and over crank LED will flash. The time between flashes indicates the Crank/Rest time. Adjust pot accordingly to increase or decrease Crank/Rest time.
- Crank-Disconnect and Over-speed pot calibration - apply power to Start/Stop. Follow procedure outlined in Step - 7. (Crank Disconnect Calibration) and Step 8. (Over-Speed Calibration).
- *Choke* and *Slow* “Timer” functions are disabled.
- On completion, reset DIP switches 1, 2 & 3 to give desired crank tries.

6: Crank/Rest Time Calibration: The Crank/Rest Time pot controls the maximum allowable cranking time per Cranking attempt, as well as the rest time between Crank attempts; it is adjustable from 4 to 36 seconds.

Note: The rest time only begins when engine speed reaches zero

To adjust Crank/Rest time:

- a) Apply power to Auto terminal # 7.
- b) Remove wire connected to Fuel terminal #11 (Fuel/Ignition). For gasoline engines you may remove the wire from the spark plug.
- c) Initiate Cranking by applying power to Start/Stop terminal #10.
- d) Measure the Amount of time the starter remains engaged. Turn pot clockwise to increase (the resolution is approx. 1.6 seconds per turn). After the starter turns off, the unit enters crank/rest mode, indicated by flashing running LED.
- e) Remove power from Start/Stop terminal, to prevent another start. Re-calibrate pot and repeat step c to confirm proper setting.

7: Crank Disconnect Calibration: The Crank Disconnect potentiometer adjusts the speed at which the controller safely disengages the starter. To adjust Crank Disconnect:

- a) Turn Over-speed pot fully **clockwise** 20+ turns.
- b) Turn Crank Disconnect pot fully **clockwise** 20+ turns.
- c) Remove wire connected to Fuel terminal #11 (Fuel/Ignition). For gasoline engines you may remove the wire from the spark coil.
- d) Initiate Cranking by applying power to Start/Stop terminal #10.
- e) Turn Crank Disconnect pot counter-clockwise until the green LED turns ON and Crank disengages (engine will stall due to missing Fuel/Ignition circuit).
- f) Remove power from Start/Stop terminal # 10.
- g) Reconnect wire to Fuel terminal # 11 (Fuel/Ignition) or reconnect spark coil wire - The resolution is 6.4 HZ/turn in speed range 1(LO) and 204.8 HZ/turn in speed range 2(HI).

Note: To proceed to STEP 9, you must ensure the controller positively detects engine start-up. If the running LED turns on momentarily and engine stalls (loss of speed: flashing Over-speed), try decreasing the Crank Disconnect pot (counter-clockwise) one half turn.

Loss of Speed While Cranking: (begins 3 seconds into crank cycle) - In the event there is a loss of speed, while cranking or running, the unit will shut down, and this is indicated by a **flashing Over-speed LED**. The Loss of Speed While Cranking function can be disabled via DIP switch # 9. When the DIP switch is in the UP or ON position, the Loss of Speed While Cranking function is enabled. When the DIP switch is in the DOWN or OFF position, the Loss of Speed While Cranking function is disabled. **NOTE: The Loss of Speed feature is maintained during all running conditions.**

Note: If unit is configured for Generator Output, there may not be enough residual voltage during cranking. The following values are minimal recommended voltages for speed signal:

20 HZ - .075 V (75mV)

60 HZ - .6V (600mV)

4500 HZ - .8V (800 mV)

8: Over-speed calibration: The Over-speed pot controls the speed at which an Over-speed failure shutdown is to be asserted. To adjust Over-speed:

- a) Start engine by applying power to Start/Stop terminal #10, allow engine to reach normal operating speed.
- b) Turn Over-speed pot counter-clockwise, slowly, until an Over-speed failure occurs.
- c) Remove power from Start/Stop terminal # 10.
- d) Turn Over-speed pot to required setting - Resolution is 12.8 HZ/turn in speed range 1(LO) and 409.6 HZ/turn in speed range 2(HI).

9: SELECTING THE MAX. NUMBER OF CRANK TRIES:

The Crank tries are adjustable from DIP switch positions 1, 2 and 3. Select the Crank tries most appropriate for your application. **Note** that an extended Crank attempt range is available, which extends the Crank time to a time spanning from 4 to 256 seconds.

CRANK ATTEMPTS	SWITCH 1	SWITCH 2	SWITCH 3	TIME RANGE
SETUP	ON	ON	ON	4 - 36 sec
6	OFF	ON	ON	4 - 36 sec
5	ON	OFF	ON	4 - 36 sec
4	OFF	OFF	ON	4 - 36 sec
3	ON	ON	OFF	4 - 36 sec
2	OFF	ON	OFF	4 - 36 sec
1	ON	OFF	OFF	4 - 36 sec
1	OFF	OFF	OFF	4 - 256 sec

10: WARMUP

A Warmup timer is provided on all ES52 series engine controllers. Terminal 19 is the Warmup timer output. This output energizes 2 minutes after the engine running LED turns on. (i.e. Speed above crank disconnect setting). When a stop signal is initiated, the Warmup output turns off.

This Warmup output can be used to control a load device, which allows a generator to warmup before connecting the load.

LED INDICATIONS

FRONT PANEL LED INDICATIONS

What the LED's look like	Condition/Failure
No LED's ON.	"Ready" unit waiting for start signal, +12/24 VDC to Auto terminal. "OFF", no +12/24 VDC to Auto terminal.
Low Oil, steady	Low Oil Pressure Failure
Low Oil, flashing	Auxiliary Input Failure
High Temperature, steady	Over-temperature Failure
Over-crank, steady	Engine would not start after specified Crank tries.
Over-Speed, steady	Speed Signal present above Over-Speed setting
Over-speed, flashing Was engine Cranking? Was engine Running?	No speed signal available while Cranking The speed signal was Zero while running. The engine has stalled, or the speed signal has been lost..
Engine Running, steady	Engine Controller is in running mode of operation.
Engine Running, flashing	Crank-rest period. Cranking will resume soon.
"Timer", steady Is Over-speed LED ON? Is Engine Running LED ON? Is the engine Cranking? If the engine is not cranking or running	10 second Air-gate timer Slow timer feature, (pot adjustable) Choke feature Glow Plug timer feature (pot adjustable)
Low Oil steady while Engine Running Flashing	Oil switch is not closed (miss-wired or not Installed). Engine will crank when oil switch verifies.
Over-speed and over crank LED's flash alternately	Invalid speed range - check DIP switches 4 & 5 Crank disconnect set too high

TROUBLESHOOTING GUIDELINES

TROUBLE	POSSIBLE CAUSE	SUGGESTED ACTION
Unit does not operate when powered to test mode	Power leads to unit are reversed	Confirm correct wiring for ground and +bat, and re-attempt testing.
	Bad ground connection from engine to controller unit.	Run wire directly from battery - to the ground terminal #6 on controller unit.
Engine starts and immediately goes into Over-speed shutdown	Over-speed pot setting too low	Increase Over-speed pot setting to desired value.
	Improper speed range setting	Check to ensure that controller is set to proper speed range (Dip SW 4 & 5)
Engine does not crank	Battery is low or terminals are dirty	Clean terminals and re-charge battery
	Crank circuitry wiring improperly connected	Refer to engine control wiring section and check crank connections
	Bad ground connection from engine to controller	Run wire directly from battery - to the ground terminal #6 on controller unit.
	Crank relay damaged. Or on board fuse is blown	Check wiring, on board 20A fuse and relay. Replace fuse, relay and re-test controller again
Engine cranks but does not start	Out of fuel	Check fuel level, add fuel if necessary
	Ignition control wiring not installed properly	Refer to engine control wiring section and check ignition connections
	Fuel relay damaged	Check fuel relay and replace if damaged.
Engine starts but shuts down after "Oil Bypass TM " period" due to low oil/high temp/extra	Oil/temp/extra input wiring improperly connected.	Check wiring for proper connections.
Engine starts, but running LED does not illuminate.	Improper speed range setting	Check to ensure that controller is set to proper speed range (DIP switches 4,5)
	Fault (short or overload) on one of the annunciator outputs	Check for fault, once fault is corrected then operation resumes.
	Crank disconnect POT set too high	Decrease crank disconnect pot setting
Annunciation output not working	Fault (short or overload) on one of the annunciator outputs	Check for fault, once fault is corrected then annunciation operation resumes.
Annunciation output not working	Fault (short or overload) on one of the annunciator outputs	Check for fault, once fault is corrected then annunciation operation resumes.
Timer LED and timer output does not activate	Timer pot set to zero	Increase timer pot setting, turn pot clockwise
Timer LED works O.K. but timer output does not activate	Fault (short or overload) on timer output.	Check for fault, once fault is corrected then output operation resumes.
Flashing Over-speed LED	Speed signal improperly connected, missing, or damaged.	Check speed signal wiring; replace damaged speed signal source.
	Crank output damaged, not working	Check wiring and replace controller
	Starter or starter solenoid damaged	Replace/repair damaged starter or starter solenoid.
Flashing Over-speed LED using Generator output	Not enough residual voltage during cranking.	Cut jumper next to DIP switch # 8, or set DIP switch # 9 to OFF if present on model
Alternating flashing of over-speed & over-crank	Crank disconnect set too high	Check crank disconnect
	Wrong speed range	Check speed range
Flashing run LED & solid oil LED	Oil switch not closed as it should be	Check oil switch wiring.
		Turn DIP switch #6 OFF to disable oil verification.
Solid oil LED immediately on start-up, without engine actually cranking or starting.	False speed signal being detected by controller. This problem can sometimes occur in installations where there is AC power from inverters near generator output lines connected to the speed signal cable.	Avoid running AC lines from inverter in same conduit as generator output lines.
		Install a small step down transformer between the speed sensing wires and the generator output.
		If the neutral from the generator output is not grounded, attach it to ground at generator.

TECHNICAL NOTES ON FREQUENTLY ASKED QUESTIONS

1. 10A Diode On Auto/Off/Test Switch On All Units With Cool-Down Or Energize To Stop Feature:

When using a single switch for auto/off /test on any ES50 series controller that has the cool-down feature, a 10A diode must be installed between test and auto with the band pointing to the auto terminal. This diode allows power to go to the auto terminal as well as the test terminal when the switch is put in test position. It is necessary to have the auto terminal powered as well as the test terminal when the unit is used in the test/manual mode. The diode offers a one-way jumper that only lets the current go from test to auto and not from auto to test. If the controller is to be used in a two-switch configuration with one being for auto and one for test, the Auto Switch has to be ON as well as the test switch when the unit is to be used in test/manual. If only the test terminal is provided with power, the unit will not operate properly.

Diode Connections For Using Auto/Off/Test Switch

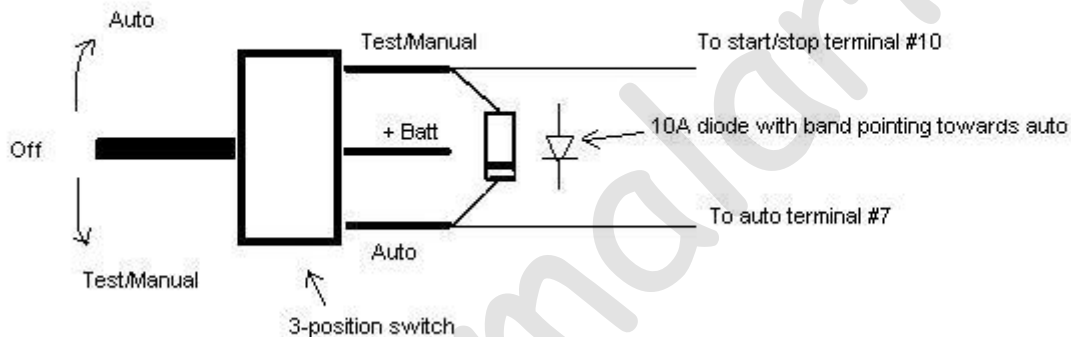

2. Controller Memory Clear Time

The ES52 needs 10 seconds for its memory to clear. When the power to the controller is turned off and then back on again without waiting a few seconds to clear the memory, a loss of speed will be indicated by the ES52 because the controller remains in run mode and senses that the generator has stopped. This would be indicated by a Flashing Overspeed LED. By leaving the ES52 OFF for 10 seconds before it is returned to the Auto setting the memory will be cleared and it will function as intended.

3. Step-Down Transformer Use On Speed Sensing Cable With Inverter Systems

In some applications engine controllers are used on generators where there is no utility connection and inverters are used to provide AC power instead of a utility. Inverters can produce harmonics that can cause small AC signals to appear on wires that are near any power lines being fed by the inverter. If the generator output wires are located close to a line being powered by an inverter, a small AC signal can appear on the generator output lines when the inverter is on. This signal can cause the engine controller to react as if the generator is running if the speed sensing wires are connected to the generator output lines. This small AC signal can cause the controller to appear to have a Low Oil Failure when the remote start contacts are closed or the controller is put in the manual/test mode. The controller may think the generator is already running and immediately check to make sure there is oil pressure. Since the engine really hasn't started yet, there is no oil pressure and the controller sees a low oil fault. This is seen as the Oil LED turning on solid even before the engine starts to engage the starter.

Without this false speed signal the controller will not look for oil pressure until the engine has started to run and the crank disengages if oil verification is disabled. Simply installing a small transformer between the generator output and the speed sensing terminals on the controller can eliminate this false speed signal. This transformer should be rated for 120 or 240 volts on the input or primary coil (depending on the generator output voltage you are using for speed sensing), and have an output voltage of around 12VAC on the secondary of the transformer. The two wires from the secondary of the transformer are connected to the two wires of the speed sensing terminals on the ES52 controller. The step-down transformer acts to reduce the false speed signal on the line to a level that the engine controller will not recognize as the engine running. A common size transformer that would serve this purpose would be 24VA.

Step Down Transformer Connections On Speed Sensing Cable

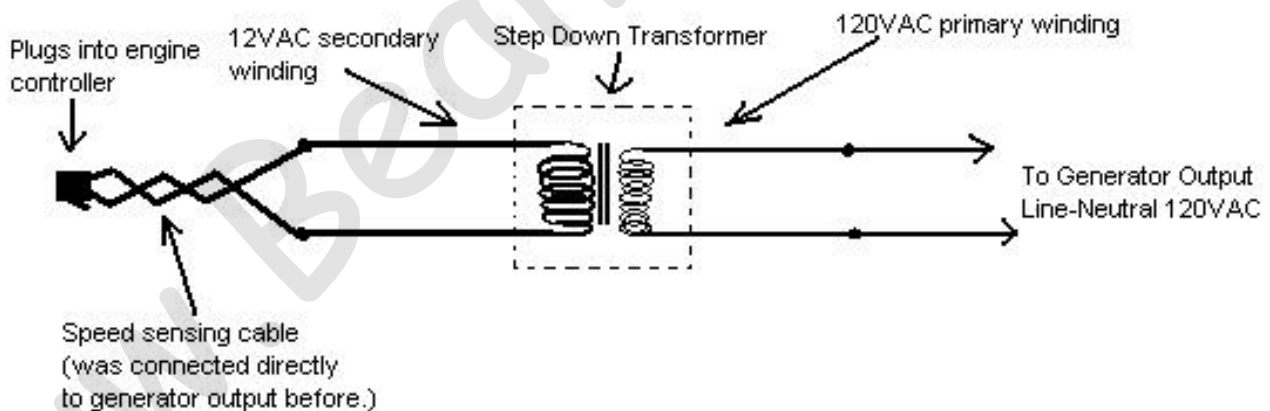

CALIBRATED

TIMER: _____
CR REST: _____
CR DISCONNECT: _____
OVERSPEED: _____
CRANK TRIES: _____