



*Thinking of you*  
**Electrolux**



EWT1276EOW

**EN** WASHING MACHINE

USER MANUAL



## CONTENTS

1. SAFETY INFORMATION.....	3
2. SAFETY INSTRUCTIONS.....	4
3. PRODUCT DESCRIPTION.....	5
4. CONTROL PANEL.....	6
5. PROGRAMME CHART.....	7
6. CONSUMPTION VALUES.....	9
7. OPTIONS.....	10
8. SETTINGS.....	12
9. BEFORE FIRST USE.....	12
10. DAILY USE.....	12
11. HINTS AND TIPS.....	16
12. CARE AND CLEANING.....	17
13. TROUBLESHOOTING.....	20
14. TECHNICAL DATA.....	23

## WE'RE THINKING OF YOU

Thank you for purchasing an Electrolux appliance. You've chosen a product that brings with it decades of professional experience and innovation. Ingenious and stylish, it has been designed with you in mind. So whenever you use it, you can be safe in the knowledge that you'll get great results every time.

Welcome to Electrolux.

Visit our website for:



Get usage advice, brochures, trouble shooter, service information:  
**[www.electrolux.com](http://www.electrolux.com)**



Register your product for better service:  
**[www.registerelectrolux.com](http://www.registerelectrolux.com)**



Buy Accessories, Consumables and Original spare parts for your appliance:  
**[www.electrolux.com/shop](http://www.electrolux.com/shop)**

## CUSTOMER CARE AND SERVICE

Always use original spare parts.

When contacting our Authorised Service Centre, ensure that you have the following data available: Model, PNC, Serial Number.

The information can be found on the rating plate.



Warning / Caution-Safety information



General information and tips



Environmental information

Subject to change without notice.

## 1. SAFETY INFORMATION

Before the installation and use of the appliance, carefully read the supplied instructions. The manufacturer is not responsible if an incorrect installation and use causes injuries and damages. Always keep the instructions with the appliance for future reference.

### 1.1 Children and vulnerable people safety

- This appliance can be used by children aged from 8 years and above and persons with reduced physical, sensory or mental capabilities or lack of experience and knowledge if they have been given supervision or instruction concerning use of the appliance in a safe way and understand the hazards involved.
- Do not let children play with the appliance.
- Keep all packaging away from children.
- Keep all detergents away from children.
- Keep children and pets away from the appliance door when it is open.
- Cleaning and user maintenance shall not be made by children without supervision.

### 1.2 General Safety

- Do not change the specification of this appliance.
- Obey the maximum load volume of 7 kg (refer to the “Programme chart” chapter).
- The operating water pressure (minimum and maximum) must be between 0,5 bar (0,05 MPa) and 8 bar (0,8 MPa).
- The ventilation openings in the base (if applicable) must not be obstructed by a carpet.
- The appliance is to be connected to the water mains using the new supplied hose-sets. Old hose sets must not be reused.
- If the supply cord is damaged, it must be replaced by the manufacturer, its Authorised Service Centre or similarly qualified persons in order to avoid a hazard.

- Before maintenance, deactivate the appliance and disconnect the mains plug from the mains socket.
- Do not use water spray and steam to clean the appliance.
- Clean the appliance with a moist soft cloth. Only use neutral detergents. Do not use abrasive products, abrasive cleaning pads, solvents or metal objects.

## 2. SAFETY INSTRUCTIONS

### 2.1 Installation

- Remove all the packaging and the transit bolts.
- Keep the transit bolts. When you move the appliance again you must block the drum.
- Always be careful when you move the appliance because it is heavy. Always wear safety gloves.
- Do not install or use a damaged appliance.
- Obey the installation instruction supplied with the appliance.
- Do not install or use the appliance where the temperature is less than 0 °C or where it is exposed to the weather.
- Make sure that the floor where you install the appliance is flat, stable, heat resistant and clean.
- Do not install the appliance where the appliance door can not be fully opened.
- Make sure that there is air circulation between the appliance and the floor.
- Adjust the feet to have the necessary space between the appliance and the carpet.

### 2.2 Electrical Connection

- The appliance must be earthed.
- Always use a correctly installed shockproof socket.
- Make sure that the electrical information on the rating plate agrees with the power supply. If not contact an electrician.
- Do not use multi-plug adapters and extension cables.

- Make sure not to cause damage to the mains plug and to the mains cable. Should the mains cable need to be replaced, this must be carried out by our Authorised Service Centre.
- Connect the mains plug to the mains socket only at the end of the installation. Make sure that there is access to the mains plug after the installation.
- Do not touch the mains cable or the mains plug with wet hands.
- Do not pull the mains cable to disconnect the appliance. Always pull the mains plug.
- Only for UK and Ireland: The appliance has a 13 amp mains plug. If it is necessary to change the fuse in the mains plug, use a 13 amp ASTA (BS 1362) fuse.
- This appliance complies with the E.E.C. Directives.

### 2.3 Water connection

- Make sure not to cause damage to the water hoses.
- Before you connect the appliance to new pipes or pipes not used for a long time, let the water flow until it is clean.
- The first time you use the appliance, make sure that there is no leakage.

### 2.4 Use



#### **WARNING!**

Risk of injury, electrical shock, fire, burns or damage to the appliance.

- Use this appliance in a household only.

- Obey the safety instructions on the detergent packaging.
- Do not put flammable products or items that are wet with flammable products in, near or on the appliance.
- Make sure that you remove all metal objects from the laundry.
- Do not put a container to collect possible water leakage under the appliance. Contact the Authorised Service Centre to ensure which accessories can be used.

## 3. PRODUCT DESCRIPTION

### 3.1 Appliance overview

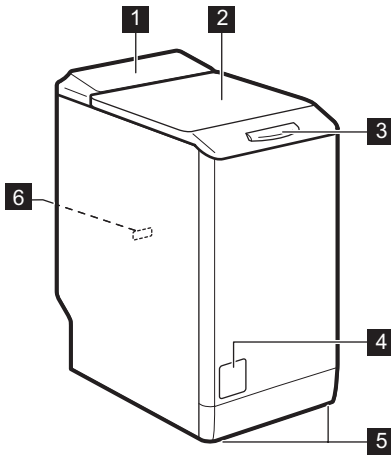

- 1** Control panel
- 2** Lid
- 3** Lid handle
- 4** Drain pump filter
- 5** Feet for the appliance level
- 6** Rating plate

## 2.5 Disposal



### **WARNING!**





Risk of injury or suffocation.



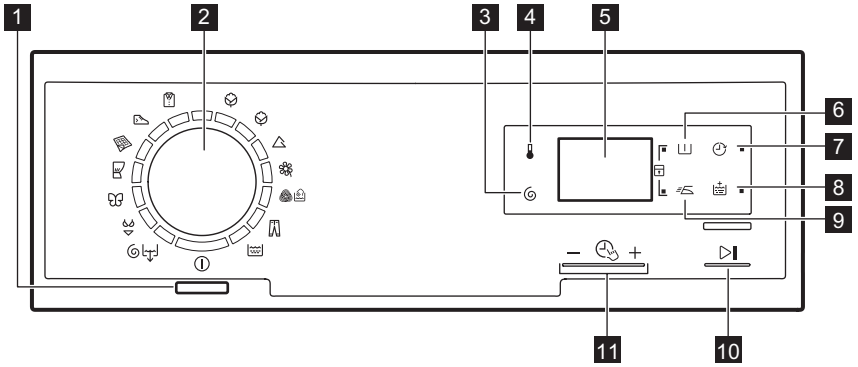



- Disconnect the appliance from the mains supply.
- Cut off the mains cable and discard it.
- Remove the door catch to prevent children and pets to get closed in the appliance.

## 4. CONTROL PANEL

### 4.1 Control panel description



- 1 On Off button 
- 2 Programme knob
- 3 Spin reduction touchpad 
- 4 Temperature touchpad 
- 5 Display
- 6 Prewash touchpad 

- 7 Delay start touchpad 
- 8 Extra rinse touchpad 
- 9 Easy iron touchpad 
- 10 Start/Pause touchpad 
- 11 Time Manager touchpads -   +



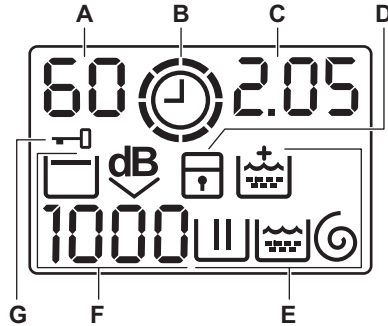







## 4.2 Display



- A)** The Temperature area:
- 88: Temperature indicator
  - : Cold water indicator
- B)** ⌚: Time Manager indicator.
- C)** The time area:
- 1.25: the programme duration
  - 2h: the delay start
  - E20: the alarm codes
  - E r r: the message of error
  - 0: the programme is completed.
- D)** 🚫: the child safety lock indicator.
- E)** Washing indicators:
- 🧺: the washing phase
  - 🌊: the rinses phase
  - 🌀: the spin phase
  - 🚰: the Extra rinse permanent option.
- F)** The spin area:
- 1888: the Spin speed indicator
  - : the No Spin indicator
  - 🧺: the Rinse Hold indicator
  - 🔇: the Extra Silent indicator.
- G)** 🚪: the Lid locked indicator

## 5. PROGRAMME CHART

Programme Temperature range	Maximum load Maximum spin speed	Programme description (Type of load and soil level)
<b>Washing programmes</b>		
🌀 Cottons 90°C - Cold	7 kg 1200 rpm	<b>White cotton and coloured cotton.</b> Normal soil and light soil.
🧺 Cottons Eco 1) 60°C - 40°C	7 kg 1200 rpm	<b>White cotton and colour-fast cotton.</b> Normal soil. The energy consumption decreases and the time of the washing programme is extended.
🔺 Synthetics 60°C - Cold	3 kg 1200 rpm	<b>Synthetic items or mixed fabric items.</b> Normal soil.

Programme Temperature range	Maximum load Maximum spin speed	Programme description (Type of load and soil level)
 Delicates 40°C - Cold	3 kg 1200 rpm	<b>Delicate fabrics as acrylics, viscose, polyester items.</b> Normal soil.
 Wool/ Handwash 40°C - Cold	1 kg 1200 rpm	<b>Machine washable wool, hand washable wool and delicate fabrics</b> with «hand washing» care symbol. <sup>2)</sup>
 Jeans 60°C - Cold	3 kg 1200 rpm	<b>Items in denim and jersey.</b> Also for dark coloured items.
 Rinse	7 kg 1200 rpm	To rinse and spin the laundry. <b>All fabrics.</b>
 Spin/ Drain <sup>3)</sup>	7 kg 1200 rpm	To spin the laundry and to drain the water in the drum. <b>All fabrics.</b>
 Lingerie 40°C - Cold	1 kg 800 rpm	Special programme for very delicate items, as lingerie, bras and underwear etc.
 Silk 30°C	1 kg 800 rpm	Special programme for <b>silk and mixed synthetic items.</b>
 Curtains 40°C - Cold	3 kg 800 rpm	Special programme for <b>curtains.</b> The prewash phase is activated automatically. <sup>4)</sup>
 Duvet 60°C - 30°C	2 kg 800 rpm	Special programme for one <b>synthetic blanket, duvet, bedspread</b> and so on.
 Sport 30°C	2.5 kg 800 rpm	<b>Synthetic and delicate items.</b> Light soil items or items to refresh.
 5 Shirts 30°C	1.5 kg 800 rpm	<b>Synthetic and mixed fabric items.</b> Light soil items and items to freshen up. For 5 - 6 shirts.

**1) Standard programmes for the Energy Label consumption values.** According to regulation 1061/2010, these programmes are respectively the «Standard 60°C cotton programme» and the «Standard 40°C cotton programme». They are the most efficient programmes in terms of combined energy and water consumption for washing normally soiled cotton laundry.



The water temperature of the washing phase may differ from the temperature declared for the selected programme.

**2)** During this cycle the drum rotates slowly to ensure a gentle washing. It can seem that the drum doesn't rotate or doesn't rotate properly. Consider this as a normal functioning of the appliance.

**3)** Set the spin speed. Make sure it agrees with the laundry. If you set No Spin option the only drain phase is available.

**4)** Do not use any detergent for prewash phase to rinse only with water.



Programme options compatibility

Programme								
	■	■	■	■	■	■	■	■
	■	■	■		■	■		■
	■	■	■	■	■	■	■	■
	■	■	■	■	■	■		■
	■	■	■	■		■		
	■	■	■		■	■		■
	■	■	■			■		■
	■	■				■		
	■	■	■	■		■		
	■	■				■		
	■	■	■			■		■
	■					■		
	■	■				■		
	■	■				■		

1) Set the spin speed. Make sure it agrees with the laundry. If you set No Spin option the only drain phase is available.

## 6. CONSUMPTION VALUES



The data of this table are approximate. Different causes can change the data: the quantity and type of laundry, the water and ambient temperature.



At programme start the display shows the duration programme for the maximum load capacity. During the washing phase the programme duration is automatically calculated and can be greatly reduced if the laundry load is lower than the maximum load capacity (e.g. Cotton 60°C, maximum load capacity 7 kg, the programme duration exceeds 2 hours; real load 1 kg, the programme duration don't reach 1 hour). When the appliance is calculating the real programme duration a dot blinks in the display.

Programmes	Load (kg)	Energy consumption (kWh)	Water consumption (litre)	Approximate programme duration (minutes)	Remaining moisture (%) <sup>1)</sup>
Cottons 60 °C	7	1,16	58	197	53
Cottons 40 °C	7	0,61	56	192	53
Synthetics 40 °C	3	0,45	46	105	35
Delicates 40 °C	3	0,55	46	90	35
Wool/Handwash 30 °C	1	0,35	50	65	30
<b>Standard cotton programmes</b>					
Standard 60 °C cotton	7	1,08	48	259	53
Standard 60 °C cotton	3.5	0,70	40	179	53
Standard 40 °C cotton	3.5	0,65	40	179	53

<sup>1)</sup> At the end of spin phase.

Off Mode (W)	Left On Mode (W)
0,48	0,48
The information given in the chart above are in compliance with the EU Commission regulation 1015/2010 implementing directive 2009/125/EC.	

## 7. OPTIONS

### 7.1 Temperature

Set this option to change the default temperature.

Indicator  = cold water.

The display shows the set temperature.

### 7.2 Spin

With this option you can decrease the default spin speed.

The display shows the indicator of the set speed.

**Additional spin options:**

**No Spin**

- Set this option to remove all spin phases.
- Set it for very delicate fabrics.
- The rinse phase uses more water for some washing programmes.
- The display shows the indicator  .

#### **Rinse Hold**

- Set this option to prevent the laundry creases.
- The washing programme stops with the water in the drum. The drum turns regularly to prevent the laundry creases.
- The lid stays locked. You must drain the water to unlock the lid.
- The display shows the indicator  .

**i** To drain the water refer to 'At the end of the programme'.

**Extra Silent**

- Set this option to remove all spin phases and to perform a silent washing.
- The rinse phase uses more water for some washing programmes.
- The washing programme stops with the water in the drum. The drum turns regularly to prevent the laundry creases.
- The lid stays locked. You must drain the water to unlock the lid.
- The display shows the indicator **dB**.

**i** To drain the water refer to 'At the end of the programme'.

**7.3 Prewash**

With this option you can add a prewash phase to a washing programme.

Use this option for heavy soil.

When you set this option the programme duration increases.

The related indicator comes on.

**7.4 Delay Start**

With this option you can delay the start of a programme from 30 minutes to 20 hours.

The display shows the related indicator.

**7.5 Extra Rinse**

With this option you can add some rinses to a washing programme.

Use this option for persons allergic to detergents and in areas where the water is soft.

The related indicator comes on.

**7.6 Easy Iron**

The appliance carefully washes and spins the laundry to prevent the creases.

The appliance decreases the spin speed, uses more water and adapts the programme duration to the type of laundry.

The related indicator comes on.

**7.7 Time Manager**

When you set a washing programme, the display shows the default duration.

Press **-** or **+** to decrease or increase the programme duration.

The Time Manager is available only with the programmes in the table.

In-di-ca-tor						
	■	■			■	
	■	■	■		■	■
	■	■			■	
	■	■	■	■	■	■
	■	■			■	
	■ <sup>3)</sup>	■ <sup>3)</sup>	■		■ <sup>3)</sup>	■
	■	■			■	
	■	■	■ <sup>3)</sup>	■ <sup>3)</sup>	■	■ <sup>3)</sup>

1) If available.

2) Shortest: to fresh the laundry.

3) Programme default duration.

4) Longest: Increasing the programme duration gradually decreases the energy consumption. The optimized heating phase saves energy and the longer duration maintains the same washing results (specially for normal soil).



## 8. SETTINGS

### 8.1 Child Lock

With this option you can prevent that the children play with the control panel.

- To **activate/deactivate** this option, press  and  at the same time until the indicator  **comes on/goes off**.

You can activate this option:

- After you press : the options and the programme knob are locked.
- Before you press : the appliance cannot start.

### 8.2 Permanent Extra Rinse

With this option you can permanently have an extra rinse when you set a new programme.



## 9. BEFORE FIRST USE

- Put a small quantity of detergent in the compartment for washing phase.
- Set and start a programme for cotton at the highest temperature without laundry.

- To **activate/deactivate** this option press  and  at the same time until the indicator  **comes on/goes off**.

### 8.3 Acoustic signals

The acoustic signals operate when:

- The programme is completed.
  - The appliance has a malfunction.
- To **deactivate/activate** the acoustic signals, press  and  at the same time for 6 seconds.



If you deactivate the acoustic signals, they continue operate when the appliance has a malfunction.

## 10. DAILY USE



### WARNING!

Refer to Safety chapters.

### 10.1 Loading the laundry

- Open the appliance lid.
- Push the button **A**.  
The drum opens automatically.
- Put the laundry in the drum, one item at a time.
- Shake the items before you put them in the appliance.  
Make sure not to put too much laundry in the drum.
- Close the drum and the lid.

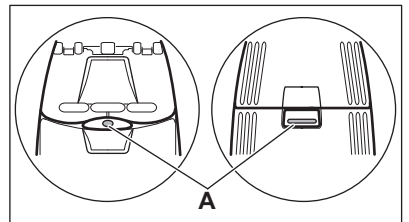

### CAUTION!

Before you close the lid of your appliance, make sure that you close the drum correctly.

### 10.2 Using detergent and additives

Measure out the detergent and the fabric conditioner.

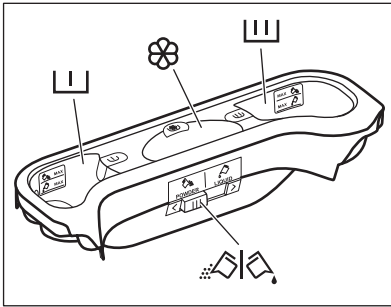

### 10.3 Detergent compartments

	Detergent compartment for prewash phase. The marks MAX are the maximum levels of the quantity of detergent (powder or liquid).
	Detergent compartment for washing phase. The marks MAX are the maximum levels of the quantity of detergent (powder or liquid).
	Compartment for liquid additives (fabric conditioner, starch). The mark <b>M</b> is the maximum level for the quantity liquid additives.
	Flap for powder or liquid detergent.

### 10.4 Liquid or powder detergent

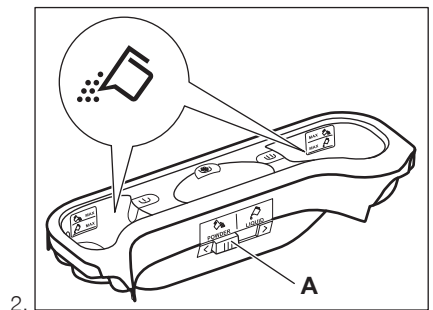
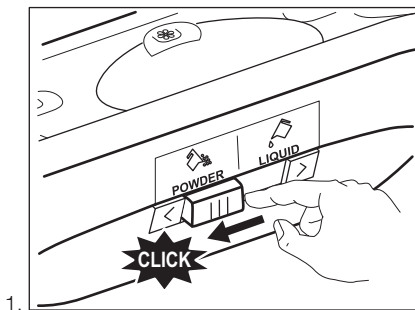

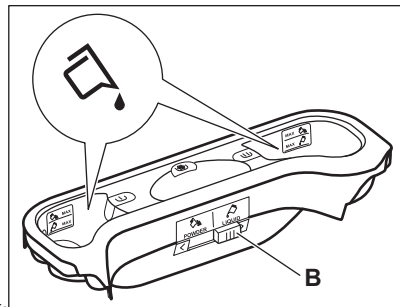
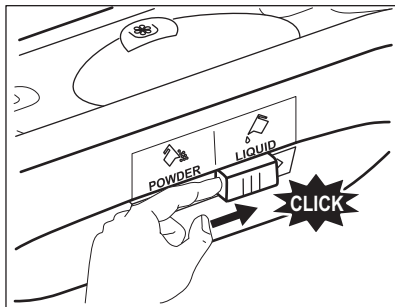

- 3.
  - 4.
- Position **A** for powder detergent (factory setting).
  - Position **B** for liquid detergent.



**When you use the liquid detergent:**

- Do not use gelatinous or thick liquid detergents.
- Do not put more liquid than the maximum level.

### 10.5 Activating the appliance

Press the  button to activate or deactivate the appliance. A tune sounds when the appliance is activated.

### 10.6 Setting a programme

1. Turn the programme knob and set the programme:
  - The related programme indicator comes on.
  - The indicator of the  flashes.
  - The display shows the level of the Time Manager, the programme duration and the indicators of the programme phases.
2. If necessary, change the temperature, the spin speed, the cycle duration or add available options. When you activate an option, the indicator of the set option comes on.





If you set something incorrect, the display shows the message **E r r**.

### 10.7 Starting a programme without the delay start

Press .

- The indicator of  stops to flash and stays on.

- The indicator  starts to flash on the display.
- The programme starts, the lid locks, the display shows the indicator .
- The drain pump can operate for a short time when the appliance fills with water.



After approximately 15 minutes from the start of the programme:

- The appliance adjusts automatically the programme duration agree with the laundry load.
- The display shows the new value.

### 10.8 Starting a programme with the delay start

1. Press  again and again until the display shows the delay you want to set.

The related indicator comes on the display.

2. Press .

- The appliance starts the countdown.

- When the countdown is completed, the programme starts automatically.



You can cancel or change the set of the delay start before you press the . To cancel the delay start:

- Press to set the appliance to pause.
- Press until the display shows .
- Press again to start the programme immediately.

## 10.9 Interrupting a programme and changing the options

You can change only some options before they operate.

1. Press .
- The indicator flashes.
2. Change the options.
  3. Press again.
- The programme continues.

## 10.10 Cancelling a programme

1. Press the button for some seconds to cancel the programme and to deactivate the appliance.
2. Press the same button again to activate the appliance. Now, you can set a new washing programme.



Before starting the new programme the appliance drains the water. Make sure that the detergent is still in the detergent compartment, if not fill the detergent again.

## 10.11 Opening the door when the delay start operates

While the delay start operates, the appliance door is locked and the display shows the indicator .

1. Press to pause the appliance.
  2. Wait until the door lock indicator goes off.
  3. Open the door.
  4. Close the door.
  5. Press again.
- The delay start continues to operate.

## 10.12 Opening the door when the programme operates

While the programme operates, the appliance door is locked and the display shows the indicator .



### CAUTION!

If the temperature and level of the water in the drum are too high, you cannot open the door.

1. Press the button for some seconds to deactivate the appliance.
2. Wait for some minutes and then open carefully the appliance door.
3. Close the appliance door.
4. Set the programme again.

## 10.13 At the end of the programme





- The appliance stops automatically.
- The acoustic signal operates (if it is activated).
- In the display comes on.
- The indicator of the goes off.
- The lid lock indicator goes off.
- You can open the lid.
- Remove the laundry from the appliance. Make sure that the drum is empty.
- Close the water tap.
- Press the button for some seconds to deactivate the appliance.

- Keep the lid ajar, to prevent the mildew and odours.

**The washing programme is completed, but there is water in the drum:**

- The drum turns regularly to prevent the creases in the laundry.
- The lid lock indicator  is on. The lid stays locked.
- You must drain the water to open the lid.

**To drain the water:**

1. Press . The appliance drains the water and spins.
2. To make the appliance drain only, set . If necessary, decrease the spin speed.
3. When the programme is completed and the lid lock indicator  goes off, you can open the lid.
4. Press the button  for some seconds to deactivate the appliance.

## 11. HINTS AND TIPS



**WARNING!**

Refer to Safety chapters.

### 11.1 The laundry load



- Divide the laundry in: white, coloured, synthetics, delicates and wool.
- Obey the washing instructions that are on the laundry care labels.
- Do not wash together white and coloured items.
- Some coloured items can discolour with the first wash. We recommend that you wash them separately for the first times.
- Button up pillowcases, close zippers, hooks and poppers. Tie up belts.
- Empty the pockets and unfold the items.
- Turn inside out multilayered fabrics, wool and items with painted illustrations.
- Remove hard stains.
- Wash with a special detergent heavy soil stains.



The appliance drains and spins automatically after approximately 18 hours (except for Wool programme).

### 10.14 AUTO Stand-by option

The AUTO Stand-by option automatically deactivates the appliance to decrease the energy consumption when:

- You do not use the appliance for 5 minutes before you press . Press the button  to activate the appliance again.
- After 5 minutes from the end of the washing programme Press the button  to activate the appliance again. The display shows the end of the last set programme. Turn the programme knob to set a new cycle.

- Be careful with the curtains. Remove the hooks or put the curtains in a washing bag or pillowcase.
- Do not wash in the appliance laundry without hems or with cuts. Use a washing bag to wash small and/or delicate items (e.g. underwired bras, belts, tights, etc. ).
- A very small load can cause balance problems with the spin phase. If this occurs, adjust manually the items in the tub and start the spin phase again.

### 11.2 Stubborn stains

For some stains, water and detergent is not sufficient.

We recommend that you remove these stains before you put the items in the appliance.

Special stain removers are available. Use the special stain remover that is applicable to the type of stain and fabric.



### 11.3 Detergents and additives

- Only use detergents and additives specially made for washing machines:
  - powder detergents for all types of fabric,
  - powder detergents for delicate fabrics (40 °C max) and woollens,
  - liquid detergents, preferably for low temperature wash programmes (60 °C max) for all types of fabric, or special for woollens only.
- Do not mix different types of detergents.
- To help the environment, do not use more than the correct quantity of detergent.
- Obey the instructions that you find on the on packaging of these products.
- Use the correct products for the type and colour of the fabric, the programme temperature and the level of soil.
- If your appliance has not the detergent dispenser with the flap device, add the liquid detergents with a dosing ball (supplied by the detergent's manufacturer).

### 11.4 Ecological hints

- Set a programme without the prewash phase to wash laundry with normal soil.
- Always start a washing programme with the maximum load of laundry.
- If necessary, use a stain remover when you set a programme with a low temperature.
- To use the correct quantity of the detergent, check the water hardness of your domestic system

### 11.5 Water hardness

If the water hardness in your area is high or moderate, we recommend that you use a water softener for washing machines. In areas where the water hardness is soft it is not necessary to use a water softener.

To know the water hardness in your area, contact your local water authority.

Use the correct quantity of the water softener. Obey the instructions that you find on the packaging of the product.

## 12. CARE AND CLEANING



**WARNING!**  
Refer to Safety chapters.

### 12.1 External cleaning

Clean the appliance only with soap and warm water. Fully dry all the surfaces.



**CAUTION!**  
Do not use alcohol, solvents or chemical products.

### 12.2 Descaling

If the water hardness in your area is high or moderate, we recommend that you use a water softener for washing machines.

Regularly examine the drum to prevent limescale and rust particles.

To remove rust particles use only special products for washing machine. Do this separately from the laundry wash.



Always obey the instructions that you find on the packaging of the product.

### 12.3 Maintenance wash

With the low temperature programmes it is possible that some detergent stays in the drum. Make regularly a maintenance wash. To do this:

- Remove the laundry from the drum.
- Set the cotton programme with the highest temperature with a small quantity of detergent.

## 12.4 Cleaning the detergent dispenser

1.

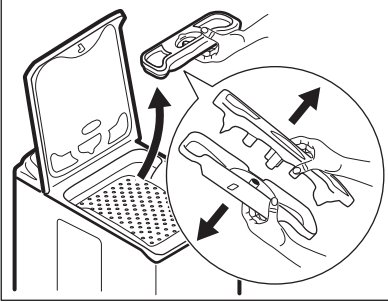

2.

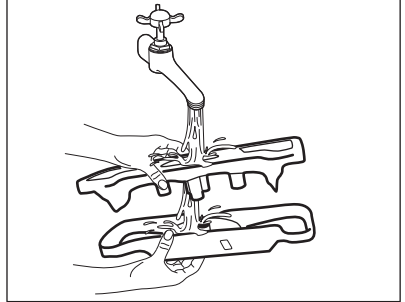

3.

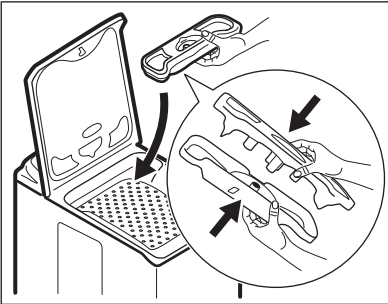

## 12.5 Cleaning the drain filter



### **WARNING!**

Do not clean the drain filter if the water in the appliance is hot.

1.

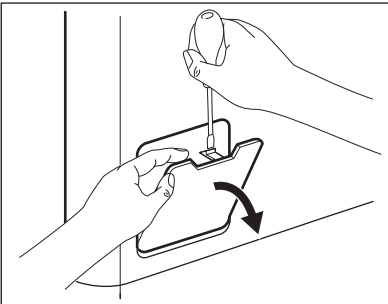

2.

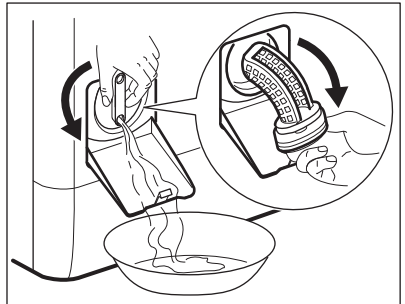

3.

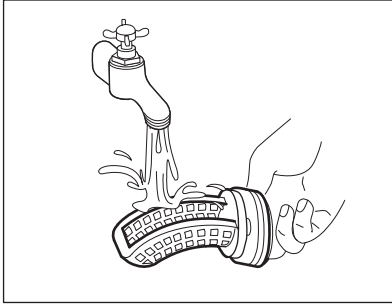

4.

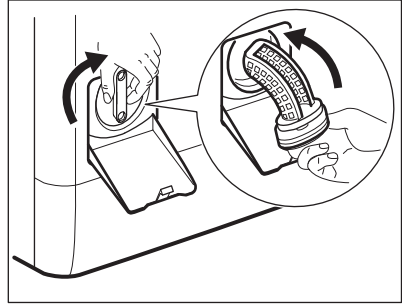

5.

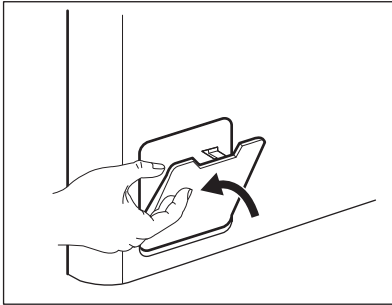

## 12.6 Cleaning the inlet hose and the valve filter

1.

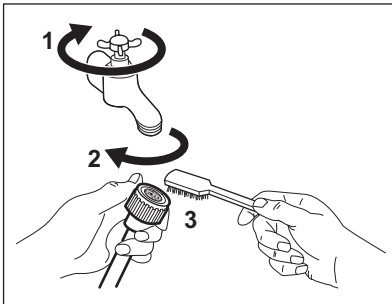

2.

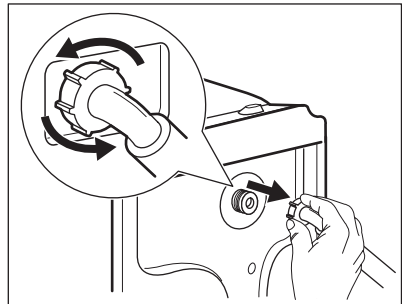

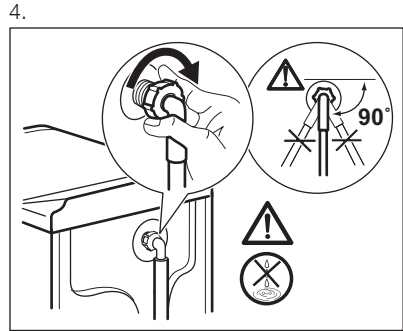
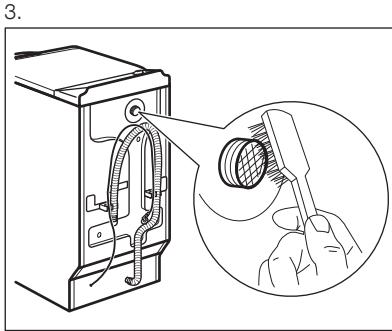

### 12.7 Emergency drain

Because of a malfunction, the appliance cannot drain the water.

If this occurs, do steps (1) through (5) of 'Cleaning the drain filter'. If necessary, clean the pump.

### 12.8 Frost precautions

If the appliance is installed in an area where the temperature can be less than 0° C, remove the remaining water from the inlet hose and the drain pump.

1. Disconnect the mains plug from the mains socket.
2. Close the water tap.
3. Put the two ends of the inlet hose in a container and let the water flow out of the hose.
4. Empty the drain pump. Refer to the emergency drain procedure.
5. When the drain pump is empty, install the inlet hose again.



#### **WARNING!**

Make sure that the temperature is more than 0 °C before you use the appliance again. The manufacturer is not responsible for damages caused by low temperatures.

## 13. TROUBLESHOOTING



#### **WARNING!**

Refer to Safety chapters.

### 13.1 Introduction

The start of the appliance does not occur or it stops during operation.

First try to find a solution to the problem (refer to the table). If not, contact the Authorised Service Centre.

**With some problems, the acoustic signals operate and the display shows an alarm code:**

- **E10** - The appliance does not fill with water properly.
- **E20** - The appliance does not drain the water.
- **E40** - The appliance door is open or not closed correctly. Please check the door!

- **EHO** - The mains supply is unstable.  
Wait until the mains supply is stable.

**WARNING!**

Deactivate the appliance before you do the checks.

### 13.2 Possible failures

<b>Problem</b>	<b>Possible solution</b>
The programme does not start.	Make sure that the mains plug is connected to the mains socket.
	Make sure that the appliance lid is closed.
	Make sure that there is not a damaged fuse in the fuse box.
	Make sure that the Start/Pause has been pressed.
	If the delay start is set, cancel the setting or wait for the end of countdown.
	Deactivate the Child Lock function if it is on.
The appliance does not fill with water properly.	Make sure that the water tap is open.
	Make sure that the pressure of the water supply is not too low. For this information, contact your local water authority.
	Make sure that the water tap is not clogged.
	Make sure that the filter of the inlet hose and the filter of the valve are not clogged. Refer to "Care and cleaning".
	Make sure that the inlet hose has no kinks or bends.
	Make sure that the connection of the water inlet hose is correct.
The appliance does not fill with water and drain immediately.	Make sure that the drain hose is in the correct position. The hose may be too low.
The appliance does not drain the water.	Make sure that the sink spigot is not clogged.
	Make sure that the drain hose has no kinks or bends.
	Make sure that the drain filter is not clogged. Clean the filter, if necessary. Refer to 'Care and cleaning'.
	Make sure that the connection of the drain hose is correct.
	Set the drain programme if you set a programme without drain phase.
	Set the drain programme if you set an option which ends with water in the tub.

<b>Problem</b>	<b>Possible solution</b>
The spin phase does not operate or the washing cycle lasts longer than usually.	Set the spin programme.  Make sure that the drain filter is not clogged. Clean the filter, if necessary. Refer to 'Care and cleaning'.
	Adjust manually the items in the tub and start the spin phase again. This problem may be caused by balance problems.
There is water on the floor.	Make sure that the couplings of the water hoses are tight and there is not water leakages.  Make sure that the drain hose have no damages.
	Make sure you use the correct detergent and the correct quantity of it.
You cannot open the appliance lid.	Make sure that the washing programme is finished.  Set the drain or the spin programme if there is water in the drum.
The appliance makes an unusual noise.	Make sure the levelling of the appliance is correct. Refer to 'Installation'.  Make sure that the packaging and/or the transit bolts are removed. Refer to 'Installation'.  Add more laundry in the drum. The load may be too small.
The cycle is shorter than the time displayed.	The appliance calculates a new time according to the laundry load. See the 'Consumption Values' chapter.
The cycle is longer than the time displayed.	An unbalanced laundry load increases the duration time. This is a normal behaviour of the appliance.
The washing results are not satisfactory.	Increase the detergent quantity or use a different detergent.  Use special products to remove the stubborn stains before you wash the laundry.  Make sure that you set the correct temperature.  Decrease the laundry load.
You cannot set an option.	Make sure that you press only the wanted touch button(s).

After the check, activate the appliance. The programme continues from the point of interruption.

If the problem occurs again, contact the Authorised Service Centre.



If the display shows other alarm codes. Deactivate and activate the appliance. If the problem continues, contact the Authorised Service Centre.

## 14. TECHNICAL DATA

Dimension	Width/ Height/ Depth/ Total depth	400 mm/ 890 mm/ 600 mm/ 600 mm
Electrical connection	Voltage	230 V
	Overall power	2200 W
	Fuse	10 A
	Frequency	50 Hz
Level of protection against ingress of solid particles and moisture ensured by the protective cover, except where the low voltage equipment has no protection against moisture		IPX4
Water supply pressure	Minimum	0,5 bar (0,05 MPa)
	Maximum	8 bar (0,8 MPa)
Water supply <sup>1)</sup>		Cold water
Maximum Load	Cotton	7 kg
Energy Efficiency Class		A++
Spin Speed	Maximum	1200 rpm

<sup>1)</sup> Connect the water inlet hose to a water tap with a 3/4" thread.

## 15. ENVIRONMENTAL CONCERNS

Recycle the materials with the symbol .  
Put the packaging in applicable containers to recycle it. Help protect the environment and human health and to recycle waste of electrical and electronic appliances. Do not dispose appliances marked with the symbol  with the household waste. Return the product to your local recycling facility or contact your municipal office.

[www.electrolux.com/shop](http://www.electrolux.com/shop)



108840302-A-192014

