

Washing Machine  
User's Manual

D2 8101 ES  
D2 8101 E

# BEKO



# Please read this manual first!

Dear Customer,

We hope that your product which has been manufactured in modern facilities and passed through a strict quality control procedure will give you the best results. Therefore, we advise you to read through this manual carefully before using your product and keep it for future reference.

## This operation manual will...

...help you use your machine in a fast and safe way.

- Please read the Operation Manual before installing and starting your machine.
- Particularly follow the instructions related to safety.
- Keep this Operating Manual within easy reach. You may need it in the future.
- Please read all additional documents supplied with this machine.

Please note that this Operating Manual may be applicable for several other models. Differences between models will be identified in the manual.

## Explanation of symbols

Throughout this Operation Manual the following symbols are used:

- ⓘ Important information or useful hints about usage.
- ⚠ Warning for hazardous situations with regard to life and property.
- ⚡ Warning for supply voltage.



This appliance's packaging material is recyclable. Help recycle it and protect the environment by dropping it off in the municipal receptacles provided for this purpose. Your appliance also contains a great amount of recyclable material. It is marked with this label to indicate the used appliances that should not be mixed with other waste. This way, the appliance recycling organised by your manufacturer will be done under the best possible conditions, in compliance with European Directive 2002/96/EC on Waste Electrical and Electronic Equipment. Contact your town hall or your retailer for the used appliance collection points closest to your home. We thank you doing your part to protect the environment.

# TABLE OF CONTENTS

<b>1 Your Washing Machine</b>	<b>4</b>	Auxiliary functions .....	19
Overview .....	4	Time display .....	19
Specifications .....	5	Starting the Program .....	20
<b>2 Warnings</b>	<b>6</b>	Progress of program .....	20
General Safety .....	6	Changing the selections after the program has started .....	21
First Use .....	6	Switching the machine to standby mode 21	
Intended use .....	6	Child-proof lock .....	21
Safety instructions .....	7	Ending the program through canceling .. 22	
If there are children in your house... ..	7	Program in rinse hold mode.....	22
<b>3 Installation</b>	<b>8</b>	End of program .....	22
Removing packaging reinforcement.....	8	<b>6 Quick instructions for daily use</b>	<b>23</b>
Opening the transportation locks .....	8	<b>7 Cleaning and care</b>	<b>25</b>
Appropriate installation location .....	8	Detergent drawer.....	25
Adjusting the feet.....	8	The door and the drum.....	25
Connecting to the water supply. ....	9	Outer cabinet and control panel.....	25
Connecting to the drain .....	9	Inlet water filters.....	25
Electrical connection .....	10	Draining any remaining water and cleaning the pump filter .....	26
Destroying the packaging material .....	10	<b>8 Solution suggestions for problems</b>	<b>28</b>
Disposing of the old machine.....	10		
<b>4 Initial preparations for washing</b>	<b>11</b>		
Sorting the laundry .....	11		
Preparing clothes for washing.....	11		
Correct load capacity .....	11		
Loading door .....	12		
Detergents and softeners .....	12		
<b>5 Selecting a Program and Operating Your Machine</b>	<b>14</b>		
Control panel.....	14		
Display symbols.....	15		
Turning the machine on .....	15		
Program selection.....	15		
Additional programs .....	16		
Special programs .....	16		
Temperature selection.....	16		
Spin Speed selection.....	17		
Program and consumption table.....	18		

# 1 Your Washing Machine

---

## Overview

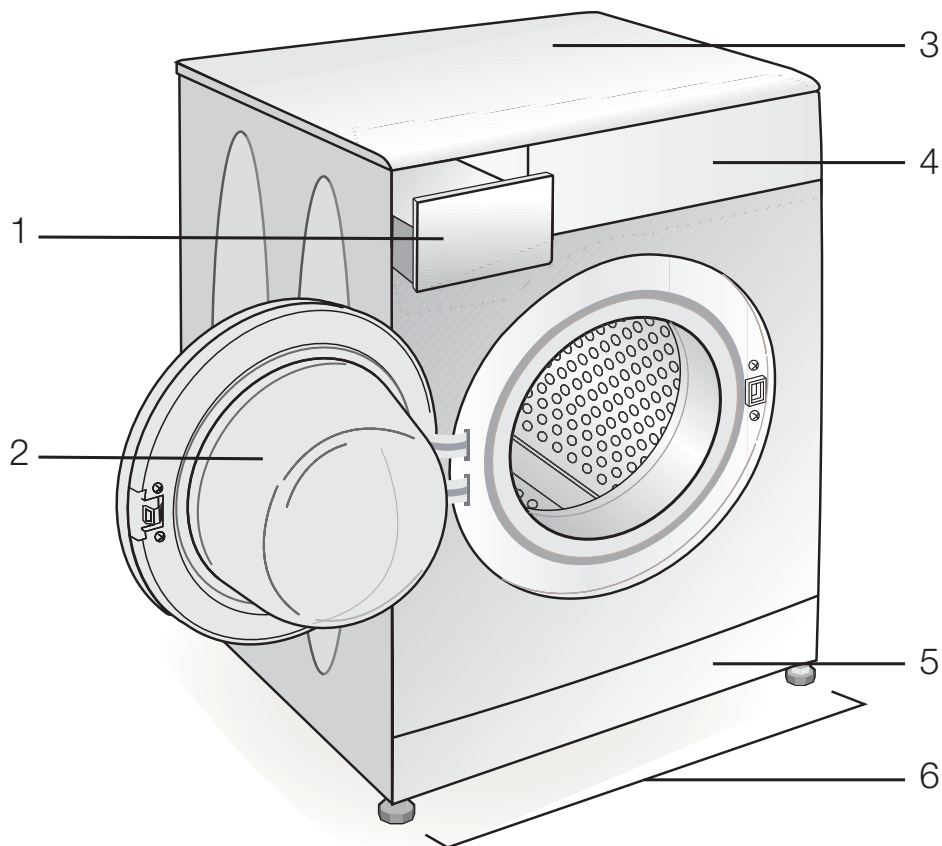

1 - Detergent Drawer

2 - Door

3 - Top Lid

4 - Control Panel

5 - Filter Cap

6 - Height-adjustable feet

## Specifications

Models	D2 8101 E	D2 8101 ES
Maximum dry laundry capacity (kg)	8	8
Height (cm)	84	84
Width (cm)	60	60
Depth (cm)	59	59
Net Weight ( $\pm 4$ kg)	74	74
Electricity (V/Hz.)	220-240 V / 50Hz	
Total Current (A)	10	10
Total Power (W)	2000-2350	
Spinning cycle (rpm max.)	1000	1000

Specifications of this appliance may change without notice to improve the quality of the product. Figures in this manual are schematic and may not match your product exactly.

Values stated on the machine labels or in the documentation accompanying it are obtained in laboratory in accordance with the relevant standards. Depending on operational and environmental conditions of the appliance, values may vary.

## 2 Warnings

---

Please read the following information. Otherwise, there may be the risk of personal injury or material damage. Moreover, any warranty and reliability commitment will become void.

### General Safety

- Never place your machine on a carpet covered floor. Otherwise, lack of airflow from below of your machine may cause electrical parts to overheat. This may cause problems with your washing machine.
- If the power cable or mains plug is damaged you must call Authorized Service for repair.
- Check water hoses for wear. Do not use old/used water inlet hoses. These may cause stains on your laundry.
- Fit the drain hose into the discharge housing securely to prevent any water leakage and to allow machine to take in and discharge water as required. It is very important that the water intake and drain hoses are not folded, squeezed, or broken when the appliance is pushed into place after it is installed or cleaned.
- Your washing machine is designed to continue operating in the event of a power interruption. You cannot cancel any program by pressing the "On/Off button." Your machine will not resume its program when the power restores. Press the "Start/ Pause/Cancel" button for 3 seconds to cancel the program (See, Cancelling a Program)
- There may be some water in your machine when you receive it. This is from the quality control process and is normal. It is not harmful to your machine.
- Some problems you may encounter may be caused by the software. Press "Start/Pause/Cancel" button

for 3 seconds to cancel the program set in your machine before calling the authorized service.

### First Use

- To prepare your machine for washing, carry out your first washing process without loading your machine and with detergent under "Cottons 90°C" program.
- Ensure that the cold and hot water connections has been made correctly when installing your machine. Otherwise, your laundry may come out hot at the end of the washing process and may wear out.
- If the current fuse or circuit breaker is less than 16 Amperes, please have a qualified electrician install a 16 Ampere fuse or circuit breaker.
- While using with or without a transformer, do not neglect to have the grounding installation laid by a qualified electrician. Our company shall not be liable for any damages that may arise when the machine is used on a line without grounding.
- To make your machine ready for use, please be sure that the tap water supply and water drainage systems are appropriate before calling the authorized service. If they are not, call a qualified plumber to have any necessary arrangements carried out.

### Intended use

- This product has been designed for home use.
- The appliance may only be used for washing and rinsing of textiles that are marked accordingly.
- Only detergents, softeners and supplements suitable for washing machines may be used.
- Observe the care instructions labelled on textile products and any other instructions given by

companies that produce detergents for your machine.

- This appliance is not intended for use by persons (including children) with reduced physical, sensory or mental capabilities, or lack of experience and knowledge, unless they have been given supervision or instruction concerning use of the appliance by a person responsible for their safety.

## **Safety instructions**

- This appliance must be connected to an earthed outlet protected by a fuse of suitable capacity.
- The supply and draining hoses must always be securely fastened and remain in an undamaged state.
- Fit the draining hose to a washbasin or bathtub securely before starting up your machine. There may be a risk of being scalded due to high washing temperatures!
- Never open the door or remove the filter while there is still water in the drum. Otherwise, there may be the risk of flooding and possible injury due to the hot water.
- Never force open the locked door! The door will be ready to open just a few minutes after the washing cycle comes to an end.
- Unplug the machine when it is not in use.
- Never wash down the appliance with a water hose! There is the risk of electric shock! Always disconnect from the mains by unplugging before cleaning.
- Never touch the plug with wet hands. Never unplug by pulling on the cable, always pull out from the plug only. Do not operate the machine if the power cord or plug is damaged.
- Never attempt to repair the machine yourself. Otherwise, you may be putting yours and other's lives in danger.
- For malfunctions that cannot

be solved by information in the operating manual:

Turn off the machine, unplug it, turn off the water tap and contact an authorized service agent.

## **If there are children in your house...**

- Electrical appliances may be dangerous for the children. Keep children away from the machine when it is operating. Do not let them tamper with the machine.
- Close the door when you leave the area where the machine is located.
- Store all detergents in a safe place out of reach of the children.

## 3 Installation

### Removing packaging reinforcement

Tilt the machine to remove the packaging reinforcement. Remove the packaging reinforcement by pulling the ribbon.



### Opening the transportation locks

ⓘ Transportation safety bolts must be removed before operating the washing machine! Otherwise, the machine will be damaged!

1. Loosen all the bolts with a spanner until they rotate freely ("C")



2. Remove transportation safety bolts by turning them gently.

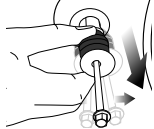

3. Fit the covers (supplied in the bag with the Operation Manual) into the holes on the rear panel. ("P")

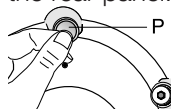

ⓘ Keep the transportation safety

bolts in a safe place to reuse when the washing machine needs to be moved again in the future.

- ⓘ Never move the appliance without the transportation safety bolts properly fixed in place!

### Appropriate installation location

Install the appliance in environments which have no risk of freezing, in a stable and level position.

- ⓘ The floor must be capable of carrying the load on it!
- ⓘ If the washing machine and a drier are placed on top of each other, their approximate weight together may reach 180 kg when they are full.

Important:

- Do not place the appliance on top of the power cable.
- Keep at least 1cm distance from the edges of other furniture.
- Place the machine on a firm surface; do not position it on a long pile rug or such like surfaces.

### Adjusting the feet

ⓘ Do not use any tools to loosen the lock nuts. Otherwise, they can be damaged.

1. Manually (by hand) loosen the lock nuts on the feet.
2. Adjust them until the machine stands level and firm.
3. Important: Tighten all lock nuts up again.

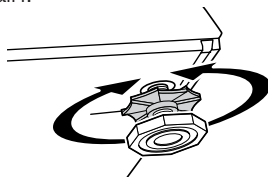



## Connecting to the water supply.

Important:

- The water supply pressure required to run the machine must be 1-10 bar (0,1 – 1,0 MPa). Attach a pressure-reducing valve if the water pressure is higher.
- Connect the special hoses supplied with the machine to the water intake valves on the machine. The hose bearing the “red” sign (90°C max) is the hot water inlet and the hose bearing the “blue” sign (25°C max) is for the cold water inlet.

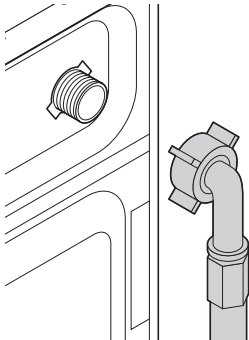

- If you are going to use your double water-inlet machine as a single (cold) water-inlet unit, you must install the stopper\*, supplied with your machine to the hot water valve. If you want to use both water inlets of the product, you can connect the hot water hose after removing the stopper and gasket group from the hot water valve.

\* Applies for the products supplied with a blind stopper group.

- Open the taps completely after making the hose connection to check if there is any water leakage at the connection points. Turn off the tap and remove the nut in case of any leakage. Retighten the nut carefully after checking the seal. To prevent any water leakage and any other damage to be caused by it, keep the taps closed when the machine is not in use.

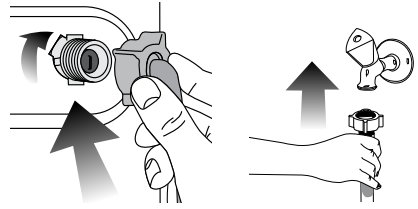

- Models with a single water inlet should not be connected to the hot water tap. Laundry may be damaged or the appliance may switch to protection mode and not work.

When returning the appliance to its place after maintenance or cleaning, care should be taken not to fold, squeeze or block the hoses.

## Connecting to the drain

The water discharge hose can be attached to the edge of a washbasin or bathtub. The drain hose should be firmly fitted into the drain as to not loosen in its housing.

Important:

- The end of the drain hose can be directly connected to the wastewater drain or to the washbasin. The fitting must be secured in all types of connections. Your house may be flooded if the hose falls out of its housing during water discharging.
- The hose should be attached to a height of at least 40 cm, and 100 cm at most.

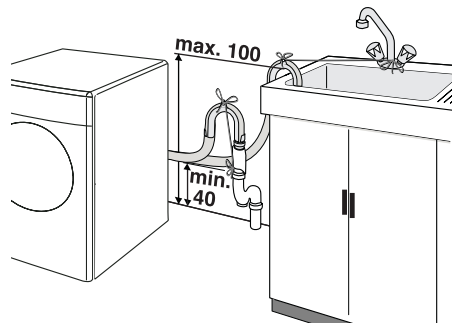

- In case the hose is elevated after laying it on the floor level or close to the ground (less than 40 cm above the ground), water discharge becomes more difficult and the laundry may come out wet. Therefore, the heights described in the figure should be followed.
- To prevent dirty water refilling the machine, and to allow for easy discharge, the end of the hose must not be submerged in the drain water. The end of the hose must be able to take in air. The hose should be pushed into the drainage for more than 15 cm. If it is too long you may have it shortened.
- The end of the hose should not be bent, it should not be stepped on and it must not be folded between the drain and the machine.
- The length of the hose is too short, you may add an extension hose to the original section. The length of the hose must not be longer than 3.2 m after coming out of the machine. To avoid water leakage failures, the connection between the extension hose and the drain hose of the product must be fitted well with an appropriate clamp as not to come off and leak.

## Electrical connection

Connect the machine to an earthed outlet protected by a fuse of suitable capacity.

Important:

- Connection should comply with national regulations.
- Power cord plug must be within easy reach after installation.
- The voltage and the allowed fuse protection are specified in the section "Technical Specifications".
- The specified voltage must be equal to your mains voltage.
- Connection via extension cords or multi-plugs should not be made.

⚠ A damaged power cable must be replaced by a qualified electrician.

⚠ The appliance must not be operated unless it is repaired! There is the risk of electric shock!

## Destroying the packaging material

Packaging material can be dangerous to children. Keep the packaging materials out of reach of children or dispose them by classifying according to waste directives. Do not dispose them together with normal domestic waste. Packaging materials of your machine are manufactured from recyclable materials.

## Disposing of the old machine

Dispose of your old appliance in an environmental friendly manner.

- You may refer to your local agent or solid waste collection center in your municipality to learn how to dispose of your machine.

Before disposing of your old washing machine, cut off the mains plug and make the door lock unusable.

## 4 Initial preparations for washing

### Sorting the laundry

- Sort the laundry according to type of fabric, color, and degree of soiling and permissible water temperature. Always follow the advice on the garment labels.

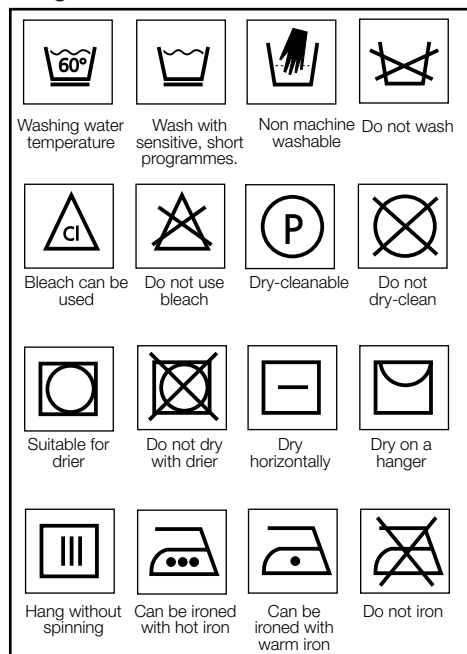

### Preparing clothes for washing

Laundry items with metal attachments such as, bras, belt buckles and metal buttons will damage the machine. Remove metal attachments or place the items in a clothing bag, pillow case, or something similar.



- Empty pockets and remove all foreign objects such as coins, pens and paper clips. If possible, turn pockets out and brush.
- Place small items like infants' socks and nylon stockings, etc. in a laundry bag, pillow case or something similar. This will also save your laundry from getting lost.
- Place curtains in the machine with care. Remove curtain rails and pullers.
- Fasten zippers, sew loose buttons and mend rips and tears.
- Wash "machine washable" or "hand washable" labelled products only with an appropriate programme.
- Do not wash colours and whites together. New, dark coloured cottons may release a lot of dye. Wash them separately.
- Tough stains must be treated properly before washing. If you are not sure, check with a dry cleaner.
- Use only dyes/colour changers and lime removers suitable for machine wash. Always follow the instructions on the packaging.
- Wash trousers and delicate clothes turned inside out.
- Keep laundry items made of Angora wool in the freezer for a few hours before washing. This will reduce pilling.

### Correct load capacity

- The maximum load capacity depends on the type of laundry, the degree of soiling and the washing programme you wish to use.
- i** The machine adjusts the amount of water according to the amount of laundry placed inside.
- i** Please follow the information in the "Programme Selection Table". Washing results will degrade when the machine is overloaded.

Following weights are given as examples.

Laundry type	Weight (gr.)
Bathrobe	1200
Napkin	100
Duvet cover	700
Bed Sheet	500
Pillowcase	200
Tablecloth	250
Towel	200
Evening gown	200
Underclothing	100
Men's overalls	600
Men's shirt	200
Men's pyjamas	500
Blouse	100

## Loading door

The door is locked during programme operation. The door can be opened after some time following the programme end.

- Open the door.
- Place laundry items loosely in the machine.
- Push the door until it clicks into place tightly. Ensure that no items are caught in the door.

## Detergents and softeners

### Detergent drawer

The detergent drawer is composed of three compartments:

The detergent dispenser may be in two different types according to the model of your machine.

- (I) for prewash
- (II) for main wash
- (III) siphon
- (☼) for softener

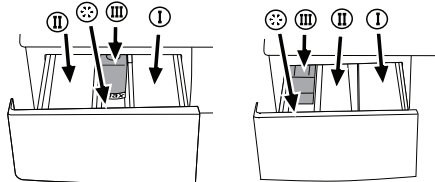

## Detergent, softener and other cleaning agents

Add detergent and softener before starting the washing programme.

Never open the detergent dispenser drawer while the washing programme is running!

When using a programme without pre-wash, no detergent should be put into the pre-wash compartment (Compartment no. I).

A programme without pre-wash should be selected if a detergent bag or a dispensing ball is going to be used. You can place the detergent bag or the dispensing ball directly among the laundry in your machine.

## Choosing the detergent type

The type of detergent to be used depends on the type and colour of fabric.

- Use different detergents for coloured and white clothes.
- Wash woolens with a special detergent specifically for woolens.
- Use only detergents manufactured specifically for automatic washing machines.

## Detergent quantity

The amount of washing detergent to be used depends on the amount of laundry, the degree of soiling and water hardness.

- Do not use amounts exceeding the quantities recommended on the package to avoid problems of excessive foam, poor rinsing, financial savings and finally, environmental protection.
- Use small amounts of detergent at a suitable measure for small amounts of laundry or for only slightly soiled laundry.
- Use exact measures for highly concentrated detergents.

	Detergent quantity
for prewashing	1/2 measure
for main washing	1 measure
with hard water	an additional 1/2 measure

### Softener

Put the softener into the softener compartment of the detergent dispenser.

- Use the proportions recommended on the packet.
- Never exceed the (> max <) level marking; otherwise, the softener will be wasted without being used.
- If the softener has lost its fluidity, dilute dense softener with water before placing it in the detergent drawer.

### Liquid detergent

When using liquid or gel washing detergents, please note the following:

- The liquid detergent may leave stains on your laundry if time delay feature is selected.
- Do not use liquid detergent if you want to wash using the time delay feature.
- Do not use liquid detergent for the main wash in a cycle with pre-wash.
- Use the detergent manufacturer's measuring cup and follow the instructions on the package.

### Starch

- Add liquid starch, powder starch or the fabric dye into the softener compartment as instructed on the package.
- Never use fabric softener and starch together in the same washing cycle.
- Wipe the inside of the drum after using starch.

### Eliminating lime formation

- When required, use only appropriate lime removers developed specifically for washing machines and always follow the instructions on the package.

## 5 Selecting a Program and Operating Your Machine

### Control panel

Figure 2

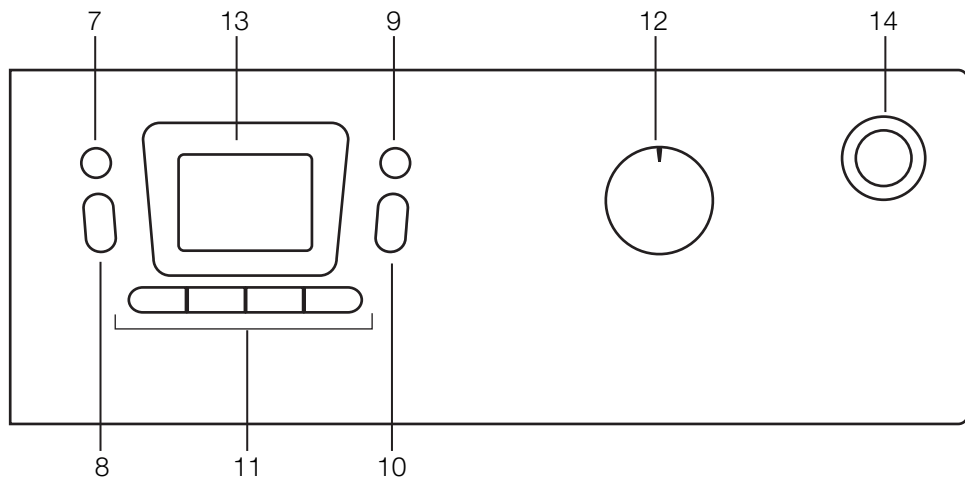

7 - Spin Speed Adjustment Button  
8 - Time Delaying Button (+/-)  
9 - Temperature Adjustment Button  
10 - Start/Pause/Cancel Button

11 - Auxiliary Function Buttons  
12 - Program Selection Knob  
13 - Display  
14 - On/Off Button

## Display symbols

Figure 3

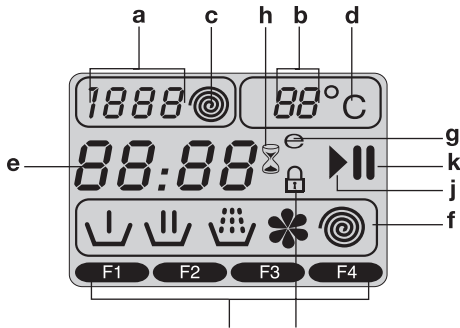

- 13.a - Spin Speed Indicator
- 13.b - Temperature Indicator
- 13.c - Spin Symbol
- 13.d - Temperature Symbol
- 13.e - Remaining Time and Delaying Time Indicator
- 13.f - Program Indicator
- Symbols (pre-wash/main wash/rinse/softener/spin)
- 13.g - Economy Symbol
- 13.h - Time Delaying Symbol
- 13.i - Door Locked Symbol
- 13.j - Start Symbol
- 13.k - Standby Symbol
- 13.l - Auxiliary Function Symbols

## Turning the machine on

Plug in your machine. Turn the tap on completely. Check if the hoses are connected tightly. Place the laundry in the machine. Add detergent and softener. Press the "On/Off" button (Figure 2-14).

## Program selection

Select the appropriate program from the program table according to type, amount and degree of soiling of the laundry and washing temperatures. Turn the Program Selection Knob (Figure 2-12) to the program mode that you wish to wash your laundry. The recommended temperature and spin speed for the selected program

appear. Press "Start/Pause/Cancel" button (Figure 2-10) to start the program.



## Main programs

Depending on the type of textile, the following main programs are available: Each of these main programs comprise of a complete washing process, including washing, rinsing and, if required, spin cycles.

- ⚠ When selecting the program you are going to use, always consider type of fabric, color, degree of soiling and permissible water temperature.
- ⚠ Always select the lowest required temperature. Higher temperature means higher power consumption.
- 📖 For further program details, see "Program Selection Table"

### • Pamuklu (Cottons)

You can wash your durable clothes with this program. Your laundry will be washed with vigorous washing movements during a longer washing cycle. It is recommended for your cotton items (such as bed sheets, duvet and pillowcase sets, bathrobes, underclothing, etc.).

### • Sentetik (Synthetics)

You can wash your less durable clothes on this program. Gentler washing movements and a shorter washing cycle is used compared to the "Cottons" program. It is recommended for your synthetic clothes (such as shirts, blouses, synthetic/cotton blended garments, etc.). For curtains and lace, the "Synthetic 40" program with pre-wash and anti-creasing functions selected is recommended. Detergent should not be put in the pre-wash compartment. Less detergent should be

put in the main wash compartment as loose knit fabrics (lace) foam too much due to its meshed structure.

#### • **Yünlü (Woollens)**

You can wash your machine-washable woolen garments on this program. Wash by selecting the proper temperature according to the labels of your clothes. It is recommended to use appropriate detergents for woollens.

### **Additional programs**

For special cases, there are also extra programs available:

**ⓘ** Additional programs may differ according to the model of your machine.

#### • **Bebek**

Increased hygiene is provided by a longer heating period and an additional rinse cycle. It is recommended for baby clothes and clothes worn by allergic people.

#### • **Eide Yıkama (Hand wash)**

You can wash your woolen/delicate clothes that bear “not machine-washable” labels for which hand wash is recommended on this program. It washes the laundry with very tender washing movements without damaging your clothes.

#### • **Express**

This program is used to wash lightly soiled and unstained cotton garments in a short time.

#### • **Express 14**

You can use this program to quickly wash a small number of lightly soiled and unstained cotton garments. E.g.: bathrobes, duvet covers, sport wear, daily clothes and etc. used only once.

#### • **Darkcare**

Use this programme to wash your dark coloured laundry, or the coloured laundry that you do not want them get faded. This programme washes your laundry with low mechanical movements and at low temperature. We recommend you to use liquid detergent or woolen shampoo for dark coloured laundry.

#### • **Mix 40**

You can use this program to wash cottons and synthetics together. There is no need to sort them.

#### • **Intensive**

You can wash your durable and heavily soiled clothes on this program. In this program, your clothes will be washed for a longer time and an extra rinse cycle will be made compared to the “Cottons” program. You can use it for your heavily soiled clothes that you wish to be rinsed gently.

#### • **Shirts**

You can use this program to wash the shirts made of cotton, synthetic and synthetic blended fabrics.

#### • **Perde (Curtain)**

You can use this program to wash your lace and curtains. It provides less creasing on lace and curtains thanks to the special spin profile of the program. Less detergent should be put in the main wash compartment as loose knit fabrics (lace) foam too much due to its meshed structure.

Never put detergent in the prewash compartment. Prewash is applied to remove the particles (such as dust or soot) on the lace/curtains, which can be removed easily.

**ⓘ** It is recommended to use special detergents for curtains in this program.

### **Special programs**

For specific applications, select any of the following programs:

#### • **Durulama (Rinse)**

This program is used when you want to rinse or starch separately.

#### • **Sıkma+Pompa (Spin + Drain)**

This program spins with maximum possible rpm in the default setting after the water drains from the machine.

**ⓘ** Use a lower spin speed for delicate laundries.

### **Temperature selection**

Whenever a new program is selected, the temperature anticipated for that



program appears on the temperature indicator (13b).

To change the temperature, press the temperature button (Figure 2-9). Temperature decreases in 10° increments.

Cold selection is shown with “-” symbol.



When the “Temperature” button is pressed after Cold is selected, the maximum temperature of the program you have selected will be displayed. To decrease the temperature, press the “Temperature” button again.

90°C	Normally soiled, white cottons and linens. (Ex.: coffee table covers, tablecloths, towels, bed sheets)
60°C	Normally soiled, fade proof colored linens, cottons or synthetic clothes (Ex.: shirts, nightgowns, pajamas) and lightly soiled white linen clothes (Ex.: underwear)
40°C 30°C Cold	Blended clothes including synthetics and woolens as well as delicates.

### Economy Symbol

Shows energy saving programs and temperature selections.

As "Intensive" and "Hygiene" programs are long programs with higher temperature selections to ensure hygiene, “Economy” Symbol (Figure 3-13g) will not light up.

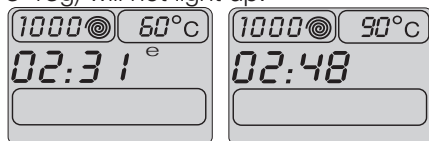

### Spin Speed selection

Whenever a new program is selected, the maximum spin speed of the selected program is displayed on the spin speed indicator (Figure 3-13a).

To decrease the spin speed, press the “Spin” button (Figure 2-7). Spin speed decreases gradually. Then, rinse hold and no spin options are shown respectively.

Rinse hold is shown with “LJ” and no spin is shown with “--” symbols.

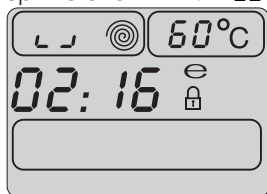

If you are not going to unload your clothes immediately after the cycle, you may use rinse hold function in order to prevent your clothes become wrinkled when there is no water in the machine. With this function, your laundry is kept in the final rinsing water. If you want to spin your laundry after the rinse hold function:

- Adjust the spin speed.
- Press “Start/Pause/Cancel” button. Program resumes. Your machine drains the water and spins your laundry.

You can use no spin function in order to drain the water without spinning at the end of the program.

## Program and consumption table

EN						Auxiliary functions						
Programme (°C)		Max. Load (kg)	Water Consumption (l)	Energy Consumption (kWh)	Max. Speed***	Ön Yıkama	Hızlı Yıkama	Rinse Plus	Kırışık Azaltma	İlave Su	Rinse Hold	Selectable temperature range °C
Pamuklu	90	8	61	2.70	1600	•	•	•	•	•	•	90-Cold
Pamuklu	60**	8	59	1.36	1600	•	•	•	•	•	•	90-Cold
Pamuklu	40	8	72	0.75	1600	•	•	•	•	•	•	90-Cold
Yorgan	40	-	60	0.60	1000							60-40
Bebek	90	8	73	2.70	1600			*			•	90-30
Sentetik	60	4	55	1.00	1000	•	•	•	•	•	•	60-Cold
Sentetik	40	4	55	0.52	1000	•	•	•	•	•	•	60-Cold
Mix 40	40	4	55	0.62	1000	•	•	•	•	•	•	40-Cold
Yünlü	40	2	56	0.30	1000			•		•	•	40-Cold
Perde	40	2	67	0.50	800	*		*	*		•	40-Cold
Elde Yıkama	30	1.5	40	0.25	1000							30-Cold
Express	90	8	70	2.00	1400			•			•	90-Cold
Express	60	8	70	1.15	1400			•			•	90-Cold
Express	30	8	80	0.20	1400			•			•	90-Cold
Express 14	30	2	35	0.10	1400			•			•	30-Cold

• : Selectable

\* : Automatically selected, not cancellable.

\*\* : Energy Label program (EN 60456)

\*\*\* If maximum spin speed of your machine is lower, selection may be made until maximum spin speed.

- : See program description for maximum load.

**i** The auxiliary functions in the table vary according to the model of your machine.

**i** Water and power consumption and program duration differ from the table subject to changes in water pressure, water hardness and temperature, ambient temperature, type and amount of laundry, selection of auxiliary functions, and changes in supply voltage.

**i** Program duration will be displayed on the screen of your machine according to your selection.

## Auxiliary functions

### Auxiliary Function Selection Buttons

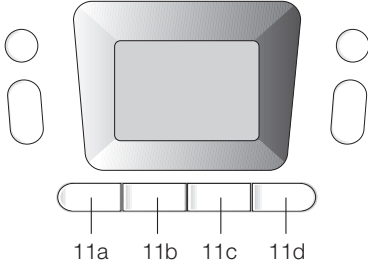

- Depending on the program, you can select the desired auxiliary function by pressing the buttons 11a, 11b, 11c, 11d.
- Select the required auxiliary functions before starting the program.
- Some combinations cannot be selected together. Ex.: Pre-wash (Figure 2-11a) and Quick Wash (Figure 2-11b).
- Symbol of the selected auxiliary function (Figure 3-13l) will light up.

### Auxiliary function selection

If an auxiliary function that should not be selected together with a previously selected function is chosen, the first selected function will be cancelled and the last auxiliary function selection will remain active.

Ex.: If you want to select pre-wash first and then quick wash, pre-wash will be cancelled and quick wash will remain active.

Auxiliary function that is not compatible with the program cannot be selected. (see, "Program Selection Table")

#### • Ön Yıkama (Prewash)

When you select this function (11a), the display will indicate "F1" symbol.

- A pre-wash is only worthwhile for heavily soiled laundry. Without pre-wash you save energy, water, detergent and time.
- Pre-wash without detergent is recommended for lace and curtains.

#### • Hızlı Yıkama (Quick Wash)

With this function (11b), the wash time is shortened. "F2" symbol lights up on the display.

- Use this function for smaller amounts or slightly soiled laundries.

#### • Rinse Plus

When this function (11c) is selected, washing and rinsing is performed with plenty of water. "F3" symbol lights up on the display.

#### • İlave Su (Plus water)

When this function is selected, washing and rinsing is made with plenty of water in "Cottons", "Synthetics", "Delicates" and "Woolens" programs.

- ☑ Use this function for delicate laundries that crease easily.
- ☑ Whenever you select this auxiliary function, load your machine with half of the maximum laundry specified in the program table.

#### • Kırışık Azaltma (Anti-Creasing)

With this function (11d), drum movement will be lessened to prevent creasing and spinning speed is limited. In addition, washing is carried out at a higher water level. "F4" symbol lights up on the display.

- Use this function for delicate laundries that crease easily.
- ☑ Whenever you select this auxiliary function, load your machine with half of the maximum laundry specified in the program table.

### Time display

The display shows the time remaining for the program to complete while a program is running. Time is displayed in hours and minutes as "01:30".

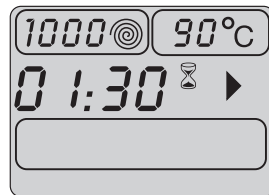

## Time delay

With the “Time delay” function you can delay the program start up to 24 hours. Setting can be made in intervals of 30 minutes.

1. Open the loading door, place the laundry inside and fill detergent drawer.
2. Set the washing program, temperature, spin speed and, if required, select the auxiliary functions.
3. Press “Time delaying” buttons “+” and “-” (Figure 2-8) to set your desired time delay. The Time delaying symbol (Figure 3-13h) will flash.
4. Press “Start/Pause/Cancel” button (Figure 2-10). Then the time delay starts to count down. The Time delaying symbol (Figure 3-13h) will light up. The Start symbol (Figure 3-13j) will light up. The “:” in the middle of the displayed time delay will start to flash.
  - More laundry may be loaded or taken out during the time delay period. At the end of the time delay countdown process, time delaying symbol (Figure 3-13h) fades and the washing starts as the program duration is displayed.

## Changing the delay time

If you want to change the time during the countdown:

1. Press “Start/Pause/Cancel” button (Figure 2-10). “:” in the middle of the screen will stop flashing. The Standby symbol (Figure 3-13k) will light up. The Time delaying symbol (Figure 3-13h) will flash. The Start Symbol (Figure 3-13j) will fade.
2. Press “Time delaying” buttons “+” or “-” (Figure 2-8) to set your desired time delay.
3. Press “Start/Pause/Cancel” button (Figure 2-10). The Time delaying symbol (Figure 3-13h) will light up. The Standby symbol (Figure 3-13k)

will fade. The Start symbol (Figure 3-13j) will light up.

4. The “:” in the middle of the displayed time delay will start to flash.

## Canceling the time delay

If you want to cancel the time delay countdown and start the program immediately:

1. Press “Start/Pause/Cancel” button (Figure 2-10). The “:” in the middle of the displayed time delay will stop flashing.
2. Start symbol (Figure 3-13j) will fade. The standby symbol (Figure 3-13k) and the time delaying symbol (Figure 3-13h) will flash.
3. Press time delaying button “-” (Figure 2-8) to decrease the desired time delay. Program duration after 30 minutes shall be displayed.
4. Press Start/Pause/Cancel Button (Figure 2-10) to start the program.

## Starting the Program

1. Press Start/Pause/Cancel button (Figure 2-10) to start the program.
2. The start symbol (Figure 3-13j) which indicates that the program has started will light up.
3. The door locks and the door locked symbol (Figure 3-13i) will light up.
4. The Symbol of the relevant step (prewash, main wash, rinse, softener and spin) that the program has started from will light up (Figure 3-13f).

## Progress of program

The progress of a running program is shown through a number of symbols on the screen.

- At the beginning of each program step, the relevant symbol in the series of symbols will light up and thus, at the end of the program, all symbols will remain lit up. The symbol that lights up at the far right of the series of symbols indicates the step that is being carried out.

### Pre-wash

When "prewash" auxiliary function is selected, prewash symbol will light up to indicate the beginning of prewash step.

### Main wash

Main wash symbol will light up to indicate that the main wash cycle has started.

### Rinse

Rinse symbol lights up at the beginning of the rinse step.

### Softener

Softener symbol lights up at the beginning of softener step.

### Spin

Spin symbol will light up at the beginning of the final spin, during "Spin" and "Pump" special programs.

- If the machine is not spinning, the program may be in rinse hold mode or the automatic spin correction system has been activated due to an excessive unbalanced distribution of laundry in the machine.

## Changing the selections after the program has started

The selected spin speed and program temperature fade out. An empty frame appears.

When the "Program selection" button is brought to the appropriate position, rpm and temperature data reappear.

## Switching the machine to standby mode

The machine is switched to standby mode by pressing "Start/Pause/Cancel" button (Figure 2-10) momentarily. The Standby symbol (Figure 3-13k) which indicates the machine is in standby mode lights up and the start symbol (Figure 3-13j) that shows the program has started and is still continuing fades out.



## Selecting or canceling an auxiliary function in pause mode

Auxiliary functions can be cancelled or selected in accordance with the step the program is at.

## Adding/removing laundry in pause mode

The door can be opened if the water level is suitable. The door locked symbol (Figure 3-13i) will light up until the door is suitable for opening. This symbol will fade out as soon as the door is allowed to open. Laundry may be added / taken out by opening the door.

## Door lock

The Door Locked Symbol (Figure 3-13i) lights up when the loading door is locked. This symbol will flash until the door is allowed to open. Do not force the door at this stage. This symbol will fade out as soon as the door is allowed to open. You may open the door after the symbol fades out.

## Child-proof lock

Protect the appliance from being tampered by children by means of the child-proof lock. In this case, no change can be made in the running program.

- ① Your machine can be turned on and off with On/Off button while the child-proof lock is activated. In this case, your machine will resume its program with child-proof lock activated.

The machine is switched to child-lock by pressing the 2nd and 4th auxiliary functions for 3 sec. "C:on" (Child-proof lock is activated) label appears on the display.

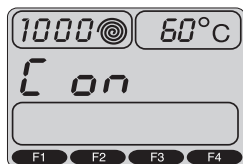

The same symbol will also be displayed whenever any button is pressed while the machine is child-locked.

To deactivate the child-proof lock, press the 2nd and 4th auxiliary function buttons for 3 sec.

“C:OFF” (Child-proof lock is deactivated) label appears on the screen.

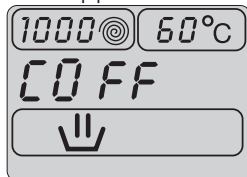

### Ending the program through canceling

“Start/Pause/Cancel” button (Figure 2-10) is pressed for 3 seconds to cancel the program. Start symbol (Figure 3-13j) will flash during cancellation. After cancellation, the symbol of the corresponding step at which the cancellation was made will remain lit and “End” will appear on the screen.

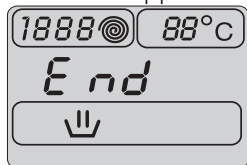

### Program in rinse hold mode

- This process is shown with the flashing Spin Symbol (Figure 3-13c) and the lit up Standby Symbol (Figure 3-13k).

If you wish to spin when the machine is in this mode:

Adjust the spin speed. Press “Start/Pause/Cancel” button (Figure 2-10).

The program continues, pumps out the water and spins. The Standby Symbol (Figure 3-13k) fades out and Start Symbol (Figure 3-13j) lights up.

If you want to discharge the water only without spinning:

Press “Start/Pause/Cancel” button (Figure 2-10). The Standby symbol (Figure 3-13k) will fade. The Start symbol (Figure 3-13j) will light up. The program continues and only drains the water.

### End of program

When the program is finished, the symbols of the relevant steps will remain lit up and the auxiliary function, spin and temperature data selected at the start-up of the program will remain selected. “End” will appear on the display.

## 6 Quick instructions for daily use

### Preparation

1. Turn the tap on completely. Check that the hose is connected tightly.
2. Place the laundry in the machine.
3. Add detergent and softener.

### Starting

1. Press the "On/Off" button.
2. Select the programme and the temperature.
3. If desired (according to your machine's model):
  - select any auxiliary function,
  - adjust the spin speed,
  - set the time delay,
4. Close the loading door.
5. Press "Start/Pause/Cancel" button.

The display shows the time remaining for the programme to complete if time delay is not set.

The display shows the time remaining for the programme to start if the time delay is set.

6. Check if the Door Locked Symbol lights up on the screen.

The Door Locked Symbol (Figure 3-2i) will light up if time delay is not set.

The Door Locked Symbol (Figure 3-2i) will fade if time delay is set.

### Cancelling a programme

1. Press and hold the "Start/Pause/Cancel" button for about 3 seconds; the Start symbol will start flashing.
2. The machine can discharge all the water or can take in water for 3 times at most to cool down the clothes and complete discharging process.

### Adding more laundry

- This is only possible under the following conditions:
  - during time delay,
- ① You may add or remove laundry during the time delay (until the programme starts). At the beginning of a washing cycle (machine allows

adding more laundry during a future step only if the water level is low enough to open the loading door or if the temperature in the machine is low).

In order to add laundry after the start-up of the programme:

1. Press "Start/Pause/Cancel" button.
2. Open the loading door and put in more laundry.
3. Close the loading door.
4. Press "Start/Pause/Cancel" button.

### Programme is in rinse hold mode

- ① This process is shown with the flashing spin symbol and the standby symbol which is lit up.

If you wish to spin when the machine is in this mode:

1. Adjust the spin speed.
2. Press "Start/Pause/Cancel" button. The programme continues, pumps out the water and spins.
3. The standby symbol fades out and the start symbol lights up.

If you want to discharge the water without spinning:

1. Press "Start/Pause/Cancel" button.
2. The standby symbol fades out and the start symbol lights up.
3. The programme continues and only pumps out the water.

### Re-spinning the laundry

The control system for an unbalanced load can pause the spinning in cases when the distribution of the laundry in the drum is not balanced.

If you want to re-spin the clothes:

1. Distribute the laundry in your machine for a balanced load.
2. Select the spin programme.
3. Adjust the spin speed.

### After the programme is finished

Programme indicator symbols on the screen will remain lit after the programme is finished. "End" will appear

on the screen.

1. Open the loading door and take out the laundry when the door locked symbol on the display fades out.
2. Press the "On/Off" button.
3. Turn the water tap off.
4. Remove any folds in the rubber seal on the loading door and check for debris.
5. Leave the loading door and detergent drawer open to dry.



## 7 Cleaning and care

### Detergent drawer

Remove any powder residue buildup in the drawer. To do this;

1. Press the dotted point on the siphon in the softener compartment and pull towards you until the compartment is removed from the machine.

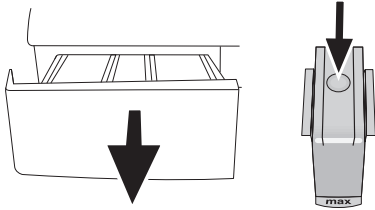

- i** If more than a normal amount of water and softener mixture starts to gather in the softener compartment, the siphon must be cleaned.
2. Wash the dispenser drawer and the siphon with plenty of lukewarm water in a washbasin. Wear protective gloves or use an appropriate brush to avoid touching the residues in the drawer when cleaning.
3. Replace the drawer into its housing after cleaning. Check if the siphon is in its original location.

### The door and the drum

After each wash:

- Check if there are any foreign substances in the drum.
- Open the hole in the bellow with the aid of a toothpick if it is clogged.

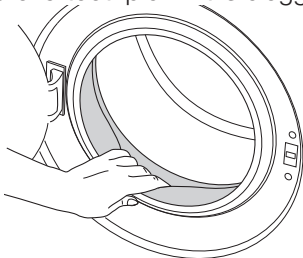

- i** Foreign metal substances in your

machine can cause rust stains. In such cases:

Clean the drum with a stainless steel cleaning agent. Never use steel wool or wire wool.

### Outer cabinet and control panel

When necessary:

- Wipe the exterior panels of your machine with soapy water or mild detergent. Dry it with a soft cloth.
  - Use only a soft and damp cloth to clean the control panel.
- i** Never use a sponge or scrubbing material. These will damage the painted and plastic parts.

### Inlet water filters

There is a filter at the end of each water intake valve at the back side of the machine and also at the end of each water intake hose where they are connected to the tap. These filters prevent the foreign substances and dirt in the water to enter into the machine. Filters should be cleaned as they get dirty.

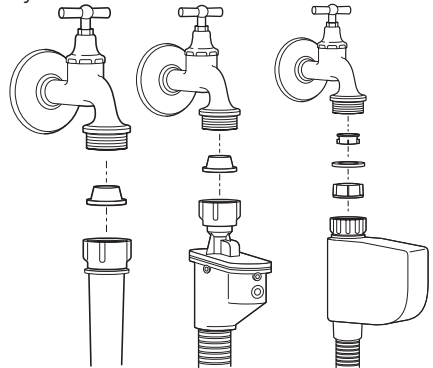

- Close the taps.
- Remove the nuts of the water intake hoses to clean the surfaces of the filters on the water intake valves with an appropriate brush.
- If the filters are very dirty, you can pull them out by means of pliers and

- clean them.
- Take out the filters on the flat ends of the water intake hoses together with the gaskets and clean thoroughly under streaming water.
- Replace the gaskets and filters carefully and tighten the hose nuts by hand.

## Draining any remaining water and cleaning the pump filter

Filter system in your machine prevents solid items such as buttons, coins and fabric fibers clogging the pump propeller during discharging of the washing water. Thus, a good water discharger is achieved and the pump life is extended.

- If your machine fails to drain the water, the pump filter may be clogged. You may have to clean it every 2 years or whenever it is blocked plugged. Water must be drained off to clean the pump filter.

In addition, water may have to be drained off completely in the following cases:

- before transporting the machine (e.g. when moving house)
- when there is the danger of frost

In order to clean the dirty filter and discharge the water;

1- Disconnect or unplug the machine from the power supply.

⚠ There may be water at 90°C in the machine. Therefore, the filter must be cleaned only after the inside water is cooled down to avoid hazard of scalding.

2- Open the filter cap. The filter cap may be composed of one or two pieces according to the model of your machine. If it is composed of two pieces, press the tab on the filter cap downwards and pull the piece out towards yourself.

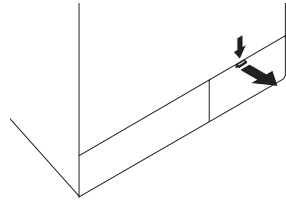

If it is composed of one piece, hold it from both sides and open it by pulling out.

- ④ You can remove the filter cover by slightly pushing the kick plate downwards with a screwdriver, through the gap above the filter cover.

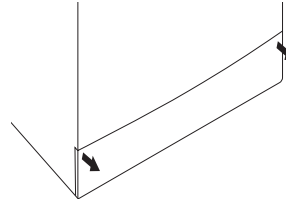

3- An emergency drain hose is supplied with some of our models. Others are not supplied with this item.

If your product is supplied with an emergency drain hose, do the following as shown in the figure below:

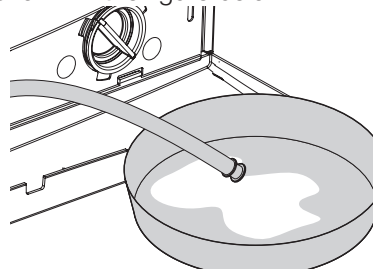

- Pull out the pump outlet hose from its housing.
- Place a large container at the end of the hose. Drain the water off into the container by pulling out the plug at the end of the hose. If the amount of water to be drained off is greater than the volume of the container, replace the plug, pour the water out,

- then resume the draining process.
- After draining process is completed, replace the plug into the end of the hose and fit the hose back into its place.

If your product is not supplied with an emergency drain hose, do the following as shown in the figure below:

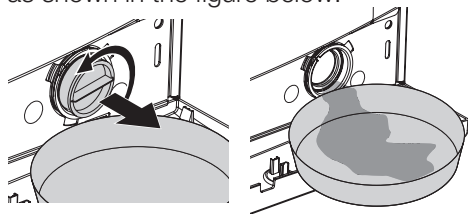

- Place a large container in front of the filter to receive water flowing from the filter.
- Loosen pump filter (anticlockwise) until water starts to flow out of it. Direct the flowing water into the container you have placed in front of the filter. You can use a piece of cloth to absorb any spilled water.
- When there is no water left, turn the pump filter until it is completely loose and remove it.
- Clean any residues inside the filter as well as fibers, if any, around the propeller region.
- If your product has a water jet feature, be sure to fit the filter into its housing in the pump. Never force the filter while replacing it into its housing. Fit the filter fully into its housing; otherwise, water may leak from the filter cap.

4- Close the filter cap.  
Close the two-piece filter cap of your product by pushing the tab on it.

Close the one-piece filter cap of your product by fitting the tabs on the bottom into their positions and pushing the upper part of it.

## 8 Solution suggestions for problems

Cause	Explanation / Suggestion
Programme cannot be started or selected.	
Machine may have switched to self protection mode due to an infrastructure problem (such as line voltage, water pressure, etc.).	Bring your machine to factory settings by turning the programme selection knob. (see, Ending the programme through Cancelling)
Water in the machine.	
There may be some water in your machine when you receive it. This is from the quality control process and is normal.	It is not harmful to your machine.
There is water coming from the bottom of the machine.	
There might be problems with hoses or the pump filter.	<ul style="list-style-type: none"> <li>- Make sure that the seals of the water inlet hoses are securely fitted.</li> <li>- Tightly attach the drain hose to the tap.</li> <li>- Make sure that the pump filter is completely closed.</li> </ul>
Machine does not fill with water	
<ul style="list-style-type: none"> <li>- Tap may be turned off.</li> <li>- Water inlet hose might be bent.</li> <li>- Water inlet filter might be clogged.</li> <li>- The loading door may be ajar.</li> </ul>	<ul style="list-style-type: none"> <li>- Open the inlet water taps fully.</li> <li>- Flatten the water intake hose.</li> <li>- Clean the water intake filter.</li> <li>- Close the loading door.</li> </ul>
Machine does not discharge water.	
<ul style="list-style-type: none"> <li>- Water outlet hose might be clogged or twisted.</li> <li>- Pump filter may be clogged.</li> </ul>	<ul style="list-style-type: none"> <li>- Clean or flatten the hose.</li> <li>- Clean the pump filter.</li> </ul>
Machine vibrates or shakes.	
<ul style="list-style-type: none"> <li>- Machine feet might not be adjusted.</li> <li>- Transportation safety bolts might have not been removed.</li> <li>- There may be a small amount of laundry in the machine.</li> <li>- The machine may be overloaded or the clothes may be distributed unevenly.</li> <li>- There machine might be touching a solid surface.</li> </ul>	<ul style="list-style-type: none"> <li>- Adjust the machine feet.</li> <li>- Remove the transportation safety bolts.</li> <li>- Add more laundry to the machine.</li> <li>- Reduce the amount of laundry in the machine or balance the load by hand.</li> <li>- Ensure that nothing touches the machine.</li> </ul>
Machine stops shortly after the programme starts.	
Machine can stop temporarily due to low voltage.	It will resume operating when the voltage is back to the normal level.
The water being taken in is directly discharged.	
Improper position of the drain hose.	Connect the water draining hose as described in the operation manual.
No water can be seen in the machine during washing.	
This is not a problem. The water level is not visible from the outside of the machine.	

The door is jammed.	
<ul style="list-style-type: none"> <li>- Water level might be above the lower level of the door.</li> <li>- Machine might be heating up the water or it may be at the spinning cycle.</li> <li>- Due to an electrical mechanism, the door can only be opened a few minutes after the programme has stopped.</li> </ul>	<ul style="list-style-type: none"> <li>- Run either the “Pump” or “Spin” programme.</li> <li>- Wait until the process is over.</li> <li>- Wait until the process is over.</li> </ul>
Machine fills with water when a process is cancelled.	
Inside of machine may be hot.	For safety reasons, water should be cycled in and out a couple times.
It continuously spins. Remaining time does not count down. (On models with display)	
There may be an imbalance of laundry in the machine.	<ul style="list-style-type: none"> <li>- The automatic spin correction system might have been activated due to the unbalanced distribution of the laundry in the drum.</li> <li>- The laundry in the drum may be clustered (bundled laundry in a bag). Laundry should be rearranged and re-spun.</li> <li>- No spinning is performed when the laundry is not evenly distributed in the drum to prevent any damage to the machine and to its environment.</li> </ul>
Washing time takes longer than the time specified in the manual	
<ul style="list-style-type: none"> <li>- Water pressure may be low.</li> <li>- Supply voltage may be low.</li> <li>- Input temperature of water may be low.</li> <li>- There may be an imbalance of laundry in the machine.</li> <li>- Number of rinses and/or amount of rinse water might have increased.</li> </ul>	<ul style="list-style-type: none"> <li>- The machine will wait until there is sufficient amount of water, which will lengthen the washing time to avoid poor washing results due to insufficient water.</li> <li>- Washing time is extended to avoid poor washing results when the supply voltage is low.</li> <li>- Cycle time is extended to heat up the water when the input water is cold. Also, washing time can be lengthened to avoid poor washing results.</li> <li>- The automatic spin correction system might have been activated due to the unbalanced distribution of the laundry in the drum.</li> <li>- The laundry in the drum may be clustered (bundled laundry in a bag).</li> <li>- Laundry should be rearranged and re-spun.</li> <li>- No spinning is performed when the laundry is not evenly distributed in the drum to prevent any damage to the machine and to its environment.</li> <li>- Water amount is increased to obtain a better rinse and a rinse cycle is added when necessary.</li> </ul>

It continuously washes. Remaining time does not count down.	
<p>In the case of a paused countdown while taking in water:</p> <ul style="list-style-type: none"> <li>- Timer will not countdown until the machine is filled with the correct amount of water. (On models with display)</li> <li>- Time might have gotten stuck during heating step. (On models with display)</li> </ul> <p>In the case of a paused countdown at the spinning step: There may be an imbalance of laundry in the machine. (On models with display)</p>	<ul style="list-style-type: none"> <li>- The machine will wait until there is sufficient amount of water to avoid poor washing results due to lack of water. Then the timer will start to count down.</li> <li>- Time will not count down until the selected temperature for the programme is attained.</li> <li>- The automatic spin correction system might have been activated due to the unbalanced distribution of the laundry in the drum.</li> <li>- The laundry in the drum may be clustered (bundled laundry in a bag). Laundry should be rearranged and re-spun.</li> <li>- No spinning is performed when the laundry is not evenly distributed in the drum to prevent any damage to the machine and to its environment.</li> </ul>
It did not spin.	
<ul style="list-style-type: none"> <li>- There may be an imbalance of laundry in the machine. Therefore, the programme might have been completed without spinning.</li> <li>- The machine will not spin if the water has not completely drained.</li> </ul>	<ul style="list-style-type: none"> <li>- The automatic spin correction system might have been activated due to the unbalanced distribution of the laundry in the drum.</li> <li>- The laundry in the drum may be clustered (bundled laundry in a bag). Laundry should be rearranged and re-spun.</li> <li>- No spinning is performed when the laundry is not evenly distributed in the drum to prevent any damage to the machine and to its environment.</li> <li>- Check the filter.</li> <li>- Check the drain hose.</li> </ul>
Washing performance is poor: Laundry turns grey	
<ul style="list-style-type: none"> <li>- Using insufficient amount of detergent for a long time,</li> <li>- Washing at low temperatures for a long time,</li> <li>- Using insufficient amount of detergent for hard waters (soil can stick to the laundry),</li> <li>- Using excessive amount of detergent (detergent can stick to the laundry).</li> </ul>	<ul style="list-style-type: none"> <li>- Use the recommended amount of detergent appropriate for water hardness and the laundry.</li> <li>- Select the proper temperature for the laundry to be washed.</li> <li>- If the water hardness is high, using an insufficient amount of detergent can cause laundry to turn grey over time.</li> <li>- It is difficult to eliminate such greyness once it occurs.</li> </ul>
Washing performance is poor: Stain could not be removed, not cleaned. Laundry could not be whitened.	
<ul style="list-style-type: none"> <li>- Insufficient amount of detergent used.</li> <li>- Excessive laundry loaded into machine</li> <li>- Wrong programme and temperature might have been selected.</li> <li>- Improper detergent may have been used.</li> <li>- Wrong type of detergent used.</li> </ul>	<ul style="list-style-type: none"> <li>- Use recommended amount of detergent appropriate for the laundry.</li> <li>- Do not load the machine in excess.</li> <li>- Select the proper programme and temperature for the laundry to be washed.</li> <li>- Put the detergent in the correct compartment.</li> <li>- Do not mix detergent with bleaching agents.</li> </ul>

<ul style="list-style-type: none"> <li>- Washing performance is poor: Oily stains appear on laundry.</li> <li>- Washing performance is poor: Bad odour</li> </ul>	
<ul style="list-style-type: none"> <li>- Oily accumulations on the drum may have stuck to the laundry.</li> <li>- Oily accumulations on the drum may have stuck to the laundry.</li> </ul>	<ul style="list-style-type: none"> <li>- Such odours and bacteria layers are formed on the drum as a result of continuous washing at lower temperatures and/or in short programmes.</li> <li>- Leave the detergent dispenser drawer as well as the loading door of the machine ajar after each washing. Thus, a humid environment favorable for bacteria cannot be created inside the machine.</li> <li>- Machine must be operated empty either at 60°C or 90°C programme with detergent every 6 months.</li> </ul>
<b>Colour of the clothes faded.</b>	
<ul style="list-style-type: none"> <li>- Excessive laundry loaded into machine.</li> <li>- Detergent may have gotten damp.</li> <li>- A higher temperature might have been selected.</li> </ul>	<ul style="list-style-type: none"> <li>- Do not load the machine in excess</li> <li>- Store detergent in a closed and dry location.</li> <li>- Do not keep them under high temperatures.</li> <li>- Select the proper programme and temperature according to the type and soiling degree of the laundry.</li> </ul>
<b>It does not rinse well.</b>	
<ul style="list-style-type: none"> <li>- The amount, brand and storage conditions of the detergent used might not be appropriate.</li> <li>- Detergent might have been put in the wrong compartment.</li> <li>- Machine filter may be clogged.</li> <li>- Drain hose may be folded.</li> <li>- Intermediate spins may be skipped.</li> </ul>	<ul style="list-style-type: none"> <li>- Store detergent in a closed and dry location. Do not keep them under high temperatures.</li> <li>- If detergent is put in the prewash compartment although prewash cycle is not selected, machine can take this detergent during rinsing or softener step.</li> <li>- Check the filter.</li> <li>- Check the drain hose.</li> <li>- There may be an imbalance of laundry in the machine.</li> <li>- The laundry in the drum may be clustered (bundled laundry in a bag). Laundry should be rearranged and re-spun.</li> <li>- No spinning is performed when the laundry is not evenly distributed in the drum to prevent any damage to the machine and to its environment.</li> </ul>
<b>Clothes stiffened.</b>	
<ul style="list-style-type: none"> <li>- Insufficient amount of detergent used.</li> <li>- The detergent may have been placed into the wrong compartment; the detergent may be mixed with the softener.</li> </ul>	<ul style="list-style-type: none"> <li>- If the water hardness is higher, using insufficient amount of detergent can cause the laundry to become stiff in time. Use appropriate amount of detergent according to the water hardness.</li> <li>- If detergent is put in the prewash compartment although prewash cycle is not selected, machine can take this detergent during rinsing or softener step.</li> <li>- Do not mix the softener with detergent when putting in the compartment.</li> <li>- Wash and clean the drawer with hot water.</li> </ul>

Clothes do not smell like the softener.	
<ul style="list-style-type: none"> <li>- Insufficient amount of detergent used.</li> <li>- The detergent was placed into the wrong compartment; the detergent was mixed with the softener.</li> </ul>	<ul style="list-style-type: none"> <li>- If the water hardness is higher, using insufficient amount of detergent can cause the laundry to become stiff in time. Use appropriate amount of detergent according to the water hardness.</li> <li>- If detergent is put in the prewash compartment although prewash cycle is not selected, machine can take this detergent during rinsing or softener step.</li> </ul> <p>Do not mix the softener with detergent when putting in the compartment. Wash and clean the drawer with hot water.</p>
Detergent residue in the dispensing drawer.	
<ul style="list-style-type: none"> <li>- Detergent may have been put in wet dispenser drawer.</li> <li>- Detergent may have gotten damp.</li> <li>- Water pressure might be low</li> <li>- The detergent in the main wash compartment might have gotten wet while taking in the prewash water..</li> <li>- Detergent might be mixed with the bleaching agent.</li> </ul>	<ul style="list-style-type: none"> <li>- Dry the detergent drawer before putting in detergent.</li> <li>- Store detergent in a closed and dry location.</li> <li>- Do not keep them under high temperatures.</li> <li>- The detergent dispenser outlet (holes) may have a problem.</li> <li>- There might be problems with the detergent dispenser valves.</li> <li>- Do not mix the softener with detergent when putting in the compartment.</li> </ul>
There is detergent left on the laundry.	
<ul style="list-style-type: none"> <li>- Excessive laundry loaded into machine.</li> <li>- Wrong programme and temperature might have been selected.</li> <li>- Wrong detergent may have been used.</li> </ul>	<ul style="list-style-type: none"> <li>- Do not load the machine in excess.</li> <li>- Select the proper programme and temperature for the laundry to be washed.</li> <li>- Use wool detergents for woolsens.</li> </ul>
There is too much foam	
<ul style="list-style-type: none"> <li>- You may not be using proper detergent for automatic washing machines.</li> <li>- Excessive amount of detergent may have been used.</li> <li>- Too much detergent may have been used for a small amount of lightly soiled laundry.</li> <li>- Detergent may have been stored improperly.</li> <li>- Type of material being washed (lace items will cause excessive foam due to their meshed structure).</li> <li>- Detergent might have been put in the wrong compartment.</li> <li>- Softener being released early.</li> </ul>	<ul style="list-style-type: none"> <li>- Use only automatic washing machine detergents in your washing machine.</li> <li>- Use only sufficient amount of detergent.</li> <li>- Use only sufficient amount of detergent.</li> <li>- Store detergent in a closed and dry location.</li> <li>- Do not store in excessively hot places.</li> <li>- Use smaller amounts of detergent for lace items.</li> <li>- If you put detergent in the prewash compartment although you have not selected a prewash cycle, the machine can take this detergent during rinsing or softener step.</li> <li>- Too much softener was put in.</li> </ul> <p>The detergent dispenser is problematic. Water is siphoned (pulling the softener into the washer early) during the fill or rinse cycles. Valves are problematic.</p>
There is foaming over the detergent drawer	
Too much detergent was used	Mix 1 tablespoonful softener and ½ liter water and pour into the main wash compartment of the detergent drawer.



Machine does work. Nothing is displayed on the screen.	The plug might not be plugged in the mains outlet.	Check the plug.
	Fuse may have blown.	Check the fuse.
	Electricity may be cut off.	Check the supply power.
	The "On/Off" button might have not been pressed.	Press this button.
The machine did not start after the program was selected and the "Start/Pause/Cancel" button was pressed.	The front door may be ajar.	
The Rinse Symbol amongst the Program Indicator Symbols is flashing. (Subject to the model of your machine, water cut-off symbol may light up too)	Water may have been cut off.	You can restart your machine by pressing the "Start/Pause/Cancel" button for a short time after ensuring that the water is not cut off.