

# satBox - ultra

S7090PVR



**DishTV S7090PVR**

500GB Hard Drive Freeview Recorder  
(Dual Tuner)



# User Manual



## Welcome

Thank you for choosing this DishTV Freeview Satellite Digital Set Top Box. You will be able to receive all Freeview Satellite digital TV channels and radio channels, as well as detailed Freeview program information with the Freeview 8 Day Electronic Program Guide, can also be tuned to non-freeview satellite channels.

For more information about Freeview visit [www.freeviewnz.tv](http://www.freeviewnz.tv)

It's really simple to use; With easy to understand on-screen menus which are operated from the remote control.



A Freeview Digital Set Top Box gives you access to over 15 free to air digital channels, without a subscription or contract. For more information on Freeview please visit [www.freeviewnz.tv](http://www.freeviewnz.tv)



This product is capable of receiving and decoding Dolby Digital Plus.

Manufactured under license from Dolby Laboratories. Dolby and the double-D symbol are trademarks of Dolby Laboratories.



This product has an HDMI connector so that you can watch high definition TV via an HDMI lead when connected to an HD Ready TV.

HDMI, the HDMI logo and High-Definition Multimedia Interface are trademarks or registered trademarks of HDMI Licensing LLC.

## Warranty & Product Registration

Please register your product to assist with warranty and product updates.  
To do this please visit [www.dishtv.co.nz](http://www.dishtv.co.nz) and click on **Warranty & Registration**

# What's in the box?

Your new set top box



Remote control



**STANDBY BUTTON**

Power On / Standby

Loop Cable



2 x AAA batteries



AV Cable



Quickstart Guide

## Rear view

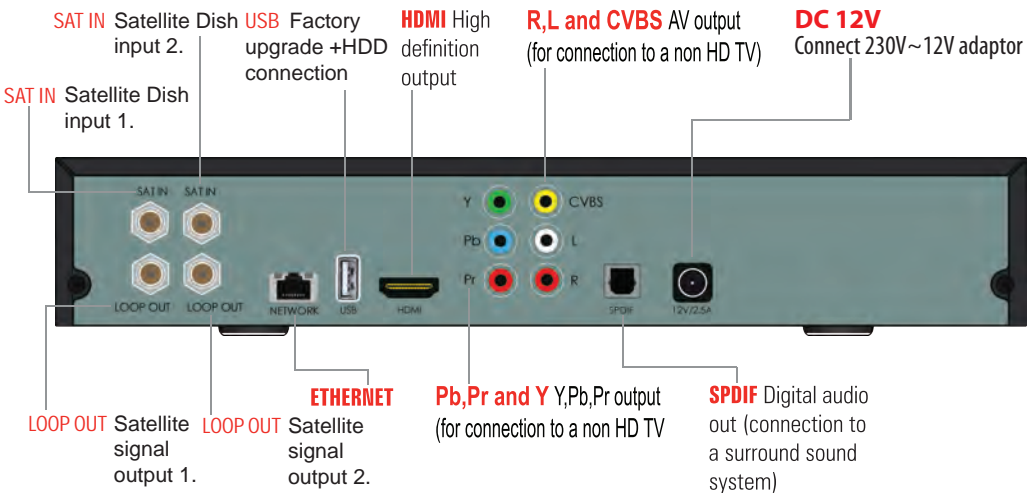

## Contents

### Contents

	Page
Your Remote Control	5
Connecting your satBox	6
Getting Started	7
<b>Main Menu</b>	8
<b>User Settings</b>	
- Favourite View	9
- Organizer	9
- User Preference	10
<b>Installation</b>	
- Tuning Wizard	
- Blind Scan	11
- Satellite Scan	12
- System Setting	13
- Country Setup	14
- Factory Default	14
- S/W upgrade via OTA	14
<b>System Configuration</b>	
- Wakeup Timer	15
- Version	15
<b>ESG</b>	16
<b>Recall List</b>	16
<b>Media Manager</b>	
- Thumbnail Browser	17
- Recorded Book List	18
- Media Information	18
- File Transfer	19
- PVR Playback from USB	20
<b>Common Interface</b>	21
<b>Connectivity</b>	22
- eNet Buttons/ eMail	
- eWeather/ eMap	23
<b>Recording</b>	24
- Timer Recording	
- Instant Recording/ Wake Up Timer	25
<b>Recordings Library</b>	26
<b>Bookmarking</b>	27
<b>Editing Recordings</b>	28
<b>Firmware Upgrade</b>	29
<b>Frequently Asked Questions</b>	30
<b>Troubleshooting/ Check Signal</b>	31
<b>Technical Specifications</b>	32
<b>Warranty</b>	33

# Your remote control

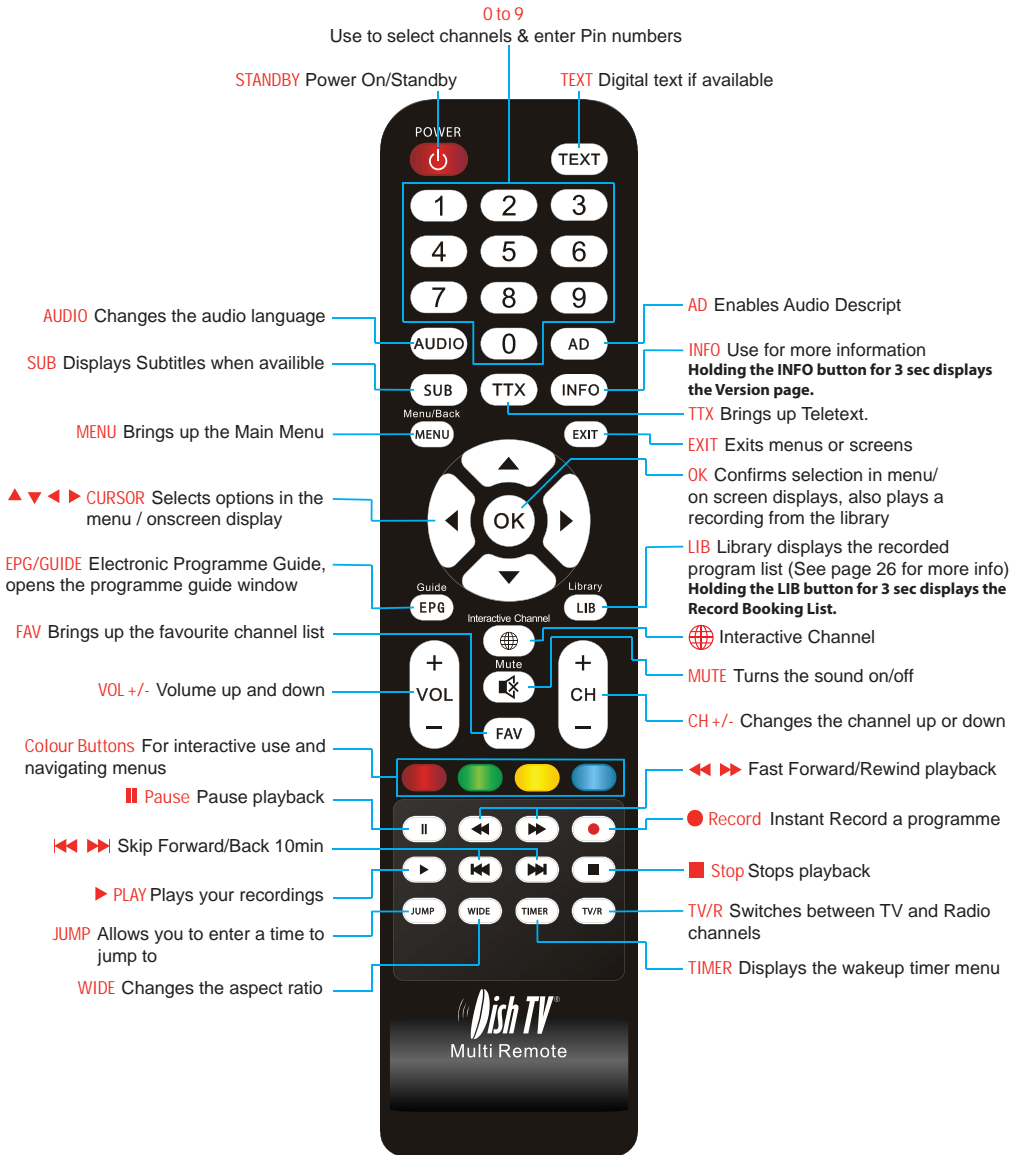

## Connecting up

Connect the supplied LNB Loop cable between the LNB 1 Loop Out connection (on the rear panel) and the LNB 2 In connection.

This links the two tuners together to allow you to record two channels and watch a third.

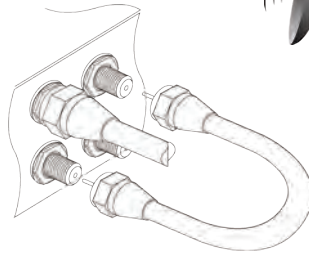

### Connecting to a HD Ready TV

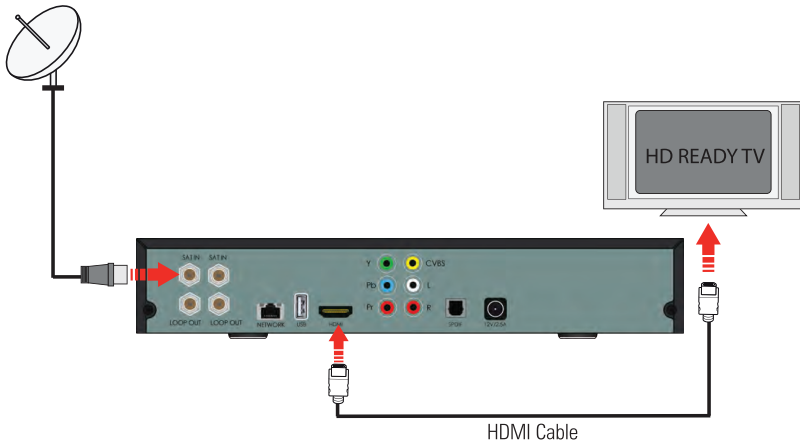

Connect that cable that comes from your Satellite dish to the SAT IN socket in the back of your set top box.

Connect the AV cable that came with your set top box between the yellow red and white sockets on the back panel of your set top box and the AV input on your TV.

### Other connections

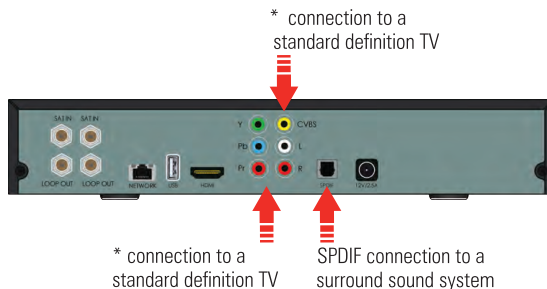

\* It is not possible to view programmes in high definition when using a standard definition TV connection.

## Getting started

1

### Put batteries in the remote control

Open the battery cover of the remote control and put two AAA size batteries so the '+' and '-' marks on the batteries match the '+' and '-' marks inside the remote control. Replace the battery cover.

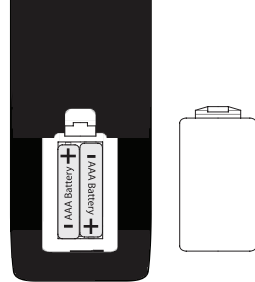

2

### Plug in and switch on

Switch your TV on and select the correct video input.

Switch the satBox ultra on and wait for it to boot up.

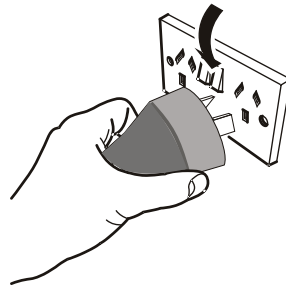

3

### The first time install screen

The Country setup install screen should appear on your TV\*. Set the Region closest to you.(this is only to receive ads for your area on TV1) and press OK.

An auto scan will now start, please do not push any buttons until it has finished. Once it has finished if the signal from your dish is good TV1 will appear and you can start using your satBox Ultra.



\* If the Country Setup screen does not appear go to the **Menu** select **Installation** then **Factory Default**. The default pin/password is 0000.

Please make sure you don't have a USB device plugged in while going through the setup process. Once you are setup you can then plug your device in.

## Main Menu

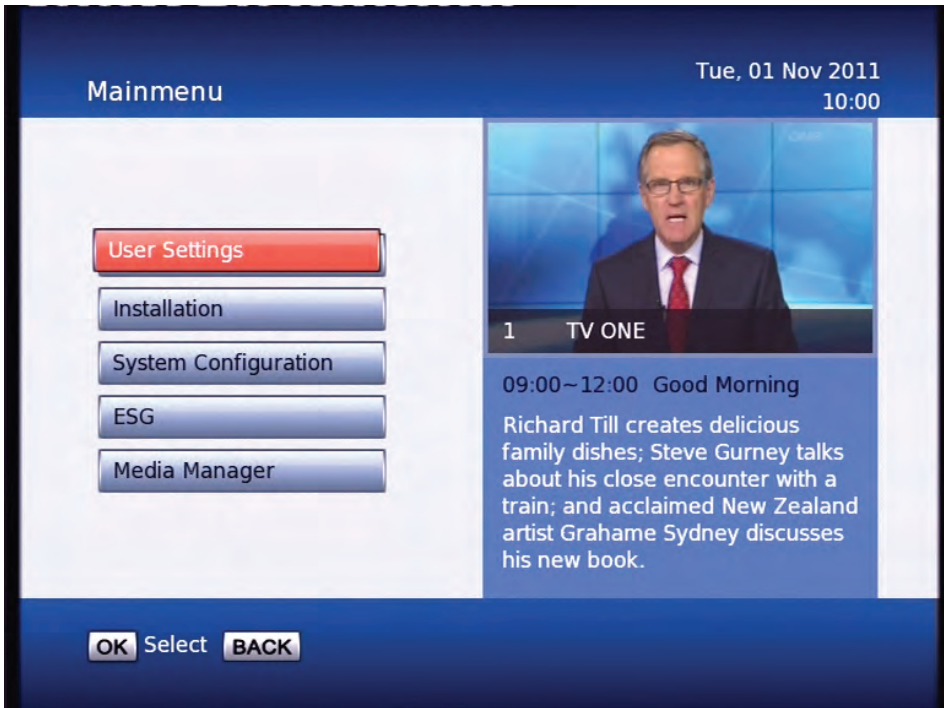

### Main Menu:

All other settings and tuning menus are selected from this main menu.

This menu is the gateway for all other menus.

You can invoke the main menu by pressing the **MENU** button.

This main menu contains several options:

**User Settings**

**Installation**

**System Configuration**

**ESG**

**Media Manager**

You can toggle between the options by using **UP/DOWN** or **LEFT/RIGHT** arrow keys in the center of the remote

To enter a sub menu from the main menu press the **OK** button.



## Main Menu - User Settings - Favourite View/Organizer

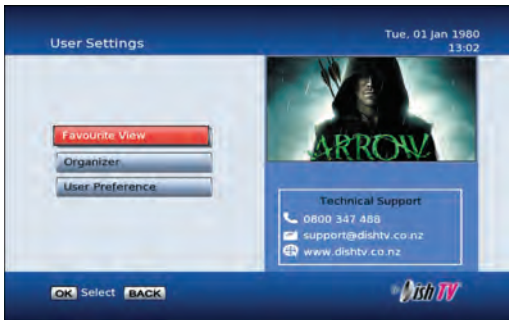

### Favourite View:

To enter this menu you will be prompted for your password (Default is 0000)

This menu allows you to view your favourite channel list and allows you to classify channels and group them together to be viewed through favourites later. These groups can then be accessed via the **FAV** button on your remote. Use the number keys on your remote according to the numbers on the right hand side of the screen to add or remove channels from your favourite group.

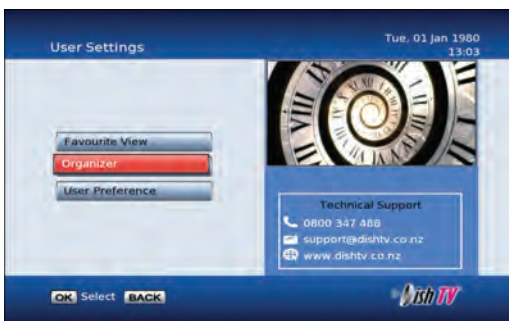

### Organizer:

To enter this menu you will be prompted for your password (Default is 0000)

In this menu you will have the options to **Lock**, **Skip** or **Delete** your channels from the list.

**Lock:** Allows you to lock a selected channel. Once a channel is set to **Lock** you will need to enter your password to view the channel.

**Skip:** Means when browsing with P+/- the selected channel will be skipped over, but is still able to be accessed by pressing the channel number button.

**Delete:** Deletes a channel off the list.

**NOTE:** Due to freeview standards channels cannot be moved around.

## Main Menu - User Settings - User Preference

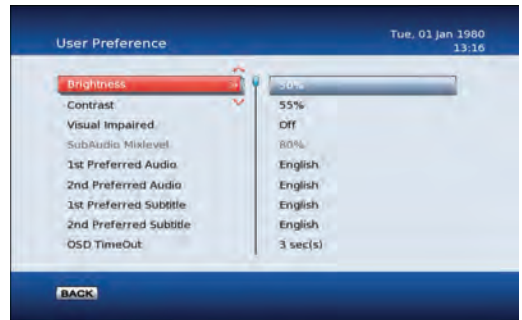

### User Preference:

**NOTE: To adjust a preference use the right arrow on your remote not the OK button. The OK button will save the changes you have made.**

Here you can adjust your **Brightness** and **Contrast** levels.

**Visual Impaired** - This option turns descriptive audio on/off. This setting is for the sight impaired.

**OSD TimeOut or On-Screen-Display timeout** - This option will adjust how long the information banners will stay on the bottom of your screen, these banners appear each time you change channel.

**Parental Rating** - To enter this option you will be prompted for your password (Default is 0000). Here you can change the password. (Passwords can only be 4 numbers.) You can also set the parental rating using the **YELLOW** and **BLUE** buttons on your remote.

**Recording Start Offset** - This option will adjust how many minutes before your program the unit will start recording. This is very handy when programs are not running on time so you don't miss part of your program.

**Recording Stop Offset** - This option will adjust how many minutes after your program the unit will stop recording. This is very handy when programs are not running on time so you don't miss part of your program.

**Auto Time Shift Mode** - When this option is on the unit will time-shift continually. Each time you change channel the previous time shift will be deleted and it will start again on that channel.

**Time Shift Mode** - When this option is on the unit will time-shift only when the Pause button is pushed.

**Time Shift Duration** - Here you can set the maximum length of your time shift.

**Load Date & Time** - It is best to leave this set to Optus D1 to keep the correct time for NZ.

## Main Menu - Installation - Tuning Wizard - Blind Scan

To enter this menu you will be prompted for your password (Default is 0000)

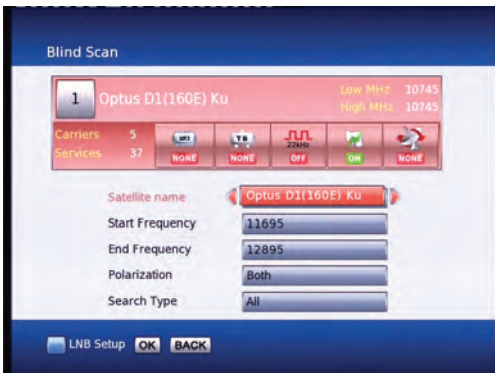
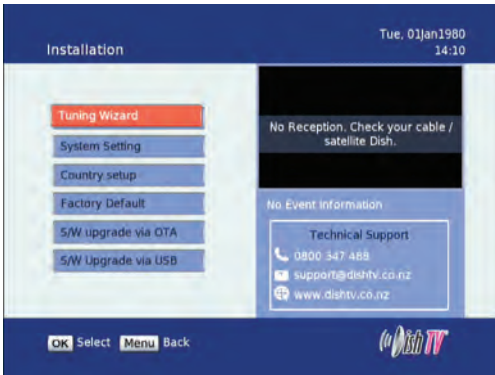

### Blind Scan

Allows you to specify what frequency range to scan. You can also select the polarity, or to scan FTA or scrambled channels.



Pressing the **BLUE** button will take you into the LNB setup menu and allow you to adjust LNB settings.

Before scanning, LNB frequency, DiSEqC and positioner details, if used, need to be set for each satellite. Press **OK** once correct settings are completed. You will be returned to the Blind Scan page.

## Main Menu - Installation - Tuning wizard - Satellite Scan



### Satellite Scan:

From here you can set all the necessary parameters i.e. LNB settings, DiSEqC, tone switch and positioner details for each satellite. All options are displayed along the bottom of the window and accessed through there. Allows you to scan a specific frequency.

Pressing the **YELLOW** button and selecting LNB setup brings you to the page shown in the screenshot on the right hand side. From here you can set the LNB settings, DiSEqC, tone switch and positioner details. Press **OK** to save changes and go back to the Satellite Scan page.

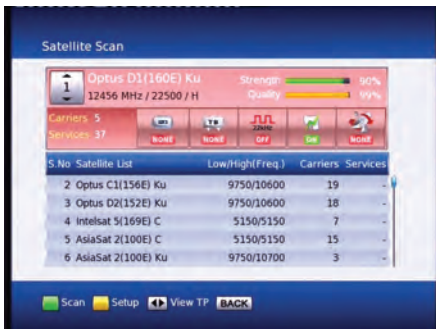

From here by pressing the **GREEN** button will do a full satellite scan, using the existing TP or Carriers in the list.

To scan just one transponder, view the transponder list by using the left/right navigation keys. The Carrier list page will display as show in the screenshot below.

Once in the Carrier list, use the up/down navigation keys to select the desired TP. Then press the **GREEN** button to perform the scan.

To add an additional TP press the **YELLOW** button and select **Add Carrier**. Type in the new TP details and press **OK** to scan. Press **Exit** to return to normal viewing once completed.

If your dish is connected and correctly aligned to the satellite you wish to scan you should get a good signal **Strength** and **Quality** reading at the top of the page. Once you have these readings you can push the **GREEN** button to start the scan.

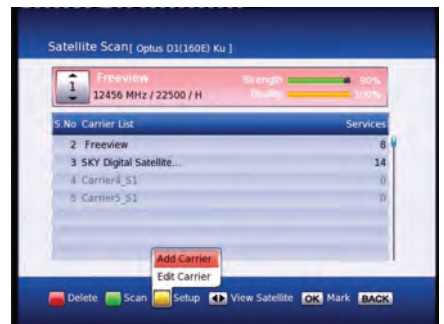

## Main Menu - Installation - System Setting



**Note:** To adjust a setting use the right arrow on your remote. To select a setting use the OK button.

**Digital Video** – Here you have the option of Auto, HDMI and DVI. DVI is HDMI video but no sound. It is best to keep this setting to HDMI. The resolution will always be 576i.

**HD Resolution** – This lets you change the output resolution of the receiver. Here you have the option of 1080i, 720p, 576p, 576i, 1080p, Native. All resolutions operate at 50Hz.

**HDMI Output Mode** – Here you can choose between Compressed Audio and UnCompressed Audio.

**HDCP** – This option turns HDCP on/off.

**Aspect Ratio** – This is to set the output picture shape depending on your TV. If you have a modern LCD or Plasma TV or a wide screen, then you most likely need to set it to 16:9. If you have an older square TV then 4:3 Panscan will most likely suit.

**LPM in stand-by** – This option turns Low Power mode on/off

**4 AM S/W upgrade** - With this option set to on your receiver will automatically update to the latest software at 4am. (When the software is broadcast)

**RF Mode** – With this setting you can adjust the RF output frequency if its conflicting with another unit or broadcast.

**Hearing Impaired** – This option is to turn subtitles on/off.



## Main Menu - Installation - Country Setup/ Factory Default/ S/W upgrade via OTA

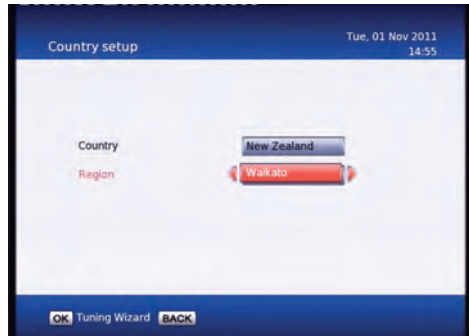
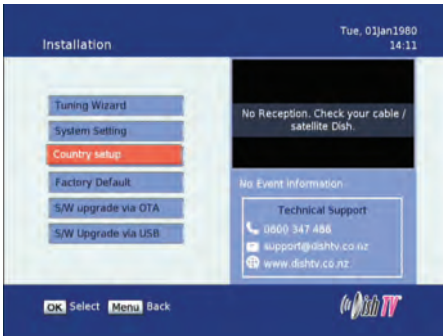

### Country Setup

Here you can change your Region. Setting this to the nearest region to you will ensure you view the Ads for your area.

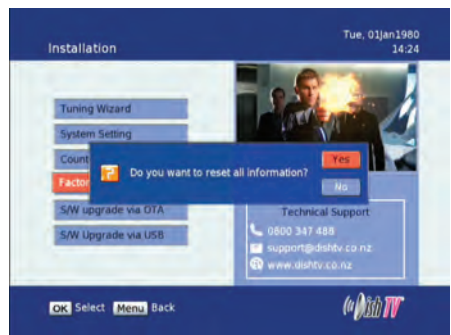
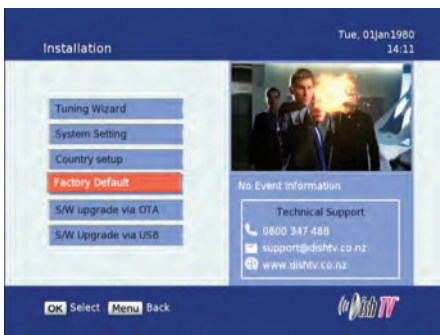

### Factory Default

This will reset all settings back to factory, deleting all channels and user settings. Default password is 0000.

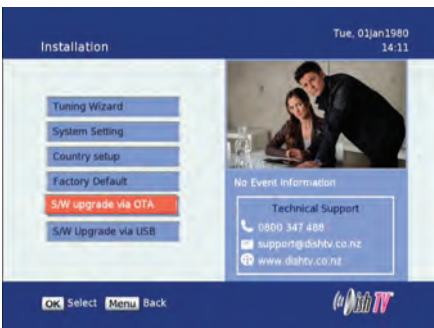

### S/W Upgrade via OTA

This option can be used only if an Over The Air software update is broadcasted via satellite. The software will only be broadcast for a few weeks when there is a major update needed. But if **Auto OTA Search** in the settings menu is set to on, you won't need to use this option.

### S/W Upgrade via USB

This option can be used only when you have a software update on a USB device currently plugged into your unit. This will start the update for you, loading the software to your unit.

## Main Menu - System Configuration - Wakeup Timer/Version

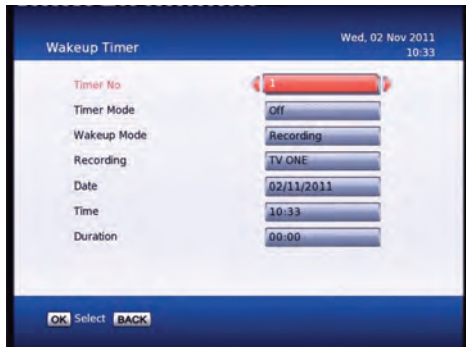

### Wakeup Timer

You can set a service to be recorded at a specific time. Even if the digital receiver is in standby mode, it will start recording at a specified time. When the recording comes to the end, the unit will stay in standby until you press the standby button. A maximum of 8 timers can be set at once.

1. Set the **Timer Mode** to **Once**, **Daily** or **Weekly** to make a recording. If this option is set to **Off**, the timer will not operate.
2. Set the **Wakeup Mode** to Recording, Services or Message. If you only want the unit to wake up on a channel at the set time without recording, set this to Services
3. Set the channel you want to record, or set the message you want to appear at the set day and time.
4. Set the **Date** option to a desired date, on which the digital receiver will turn on. Use the left, right buttons on your remote to navigate and change. The date format is Day/Month/Year.
5. Set the start **Time** option to a desired time, at which the recording will be started. Use the left, right and number buttons on your remote to navigate and change. The time format is Hour:Minute.
6. Set the **Duration** option to a desired length of time, in which the recording will be finished. Use the left, right and number buttons on your remote to navigate and change.



### Version

This is an information page only. Here you can find your units Software/ Firmware version.



## Main Menu - ESG



### ESG

The ESG is an Electronic Service Guide. This is in addition to the freeview EPG (accessed using the EPG button). Usually you will only use the ESG for non-freeview satellite channels. The ESG will be displayed when selecting the ESG option from the Main Menu. It will list the available services and when focus is set to the current service then its corresponding current and next events are displayed.



When in the ESG schedule dialog and the **INFO** button is pressed on the selected event a short description is shown above, pressing the **INFO** button again will give an extended description of the selected event that will be displayed.

### Recall List

The Recall List is a feature available that allows you to bring up a horizontal list of selectable thumbnails, which shows all the channels you have been watching since last turning on your unit.

To bring up the Recall List, simply hold down the **EXIT** button for 3 seconds.





## Main Menu - Media Manager - Thumbnail Browser

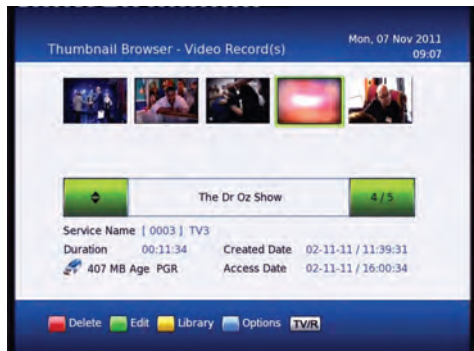

Here you can browse through your recorded programs as thumbnails, the title and information for your recording is displayed below for the selected thumbnail/recording. The information displayed includes the duration of your recording, the size, the age rating (eg G, PGR, AO), the recordings created date and also the access date. The access date is the date and time the recording was last viewed. If the access date is blank this means the recording has not yet been viewed. The thumbnail browser can be accessed from the library by pushing the LIB button.

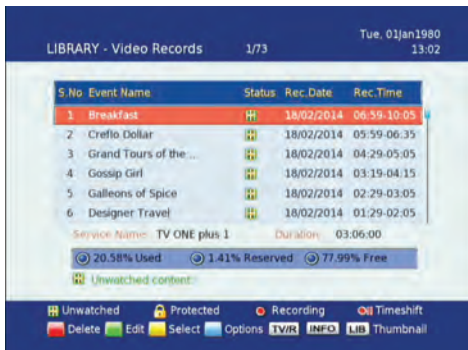

If you push the **Yellow** button when in the thumbnail browser, this will take you to the recording library where you can view your recordings by title. Here you can select and delete multiple recordings.

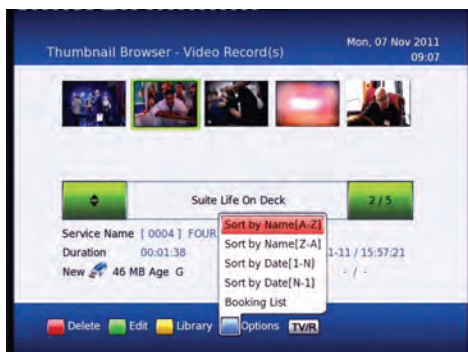

By pushing the **Blue** button you will see the sort by options. You can also go directly to the recording booklist using the blue button and selecting **Booking List**.

## Main Menu - Media Manager - Recorded Book List/Media Information

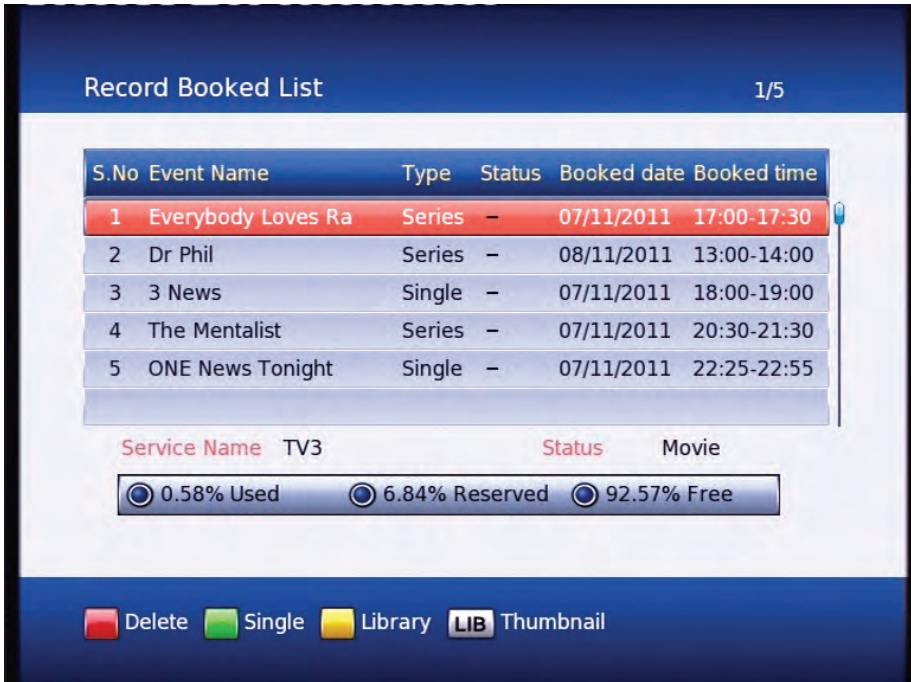

Record Booked List 1/5

S.No	Event Name	Type	Status	Booked date	Booked time
1	Everybody Loves Ra	Series	-	07/11/2011	17:00-17:30
2	Dr Phil	Series	-	08/11/2011	13:00-14:00
3	3 News	Single	-	07/11/2011	18:00-19:00
4	The Mentalist	Series	-	07/11/2011	20:30-21:30
5	ONE News Tonight	Single	-	07/11/2011	22:25-22:55

Service Name TV3      Status Movie

0.58% Used     
  6.84% Reserved     
  92.57% Free

To view the **Record Booked List**, Hold down the **LIB** button for 3 seconds while viewing a channel. Or if you are in the library press the **Options** button (**Blue**) and select it in the options list that appears. Here you can view all your programs waiting to record. You can use the **Red** button on your remote to delete a booking. The **Green** button on your remote will change the selected booking between a single record or a series booking. The **Yellow** button will take you to the recordings library. A max of 16 bookings can be made. (This limit may be increased in the future.)



Media Information Mon, 07 Nov 2011  
15:42

S.No	Interface	Disc	Drive	File System	Drive Type
1	SATA	Disc	G:	Proprietary	Recorder

Video Titles      5      Total Space      211Hours  
 Audio Titles      0      Used Space      0.58%  
 Photo Titles      0      Free Space      92.57%  
 Reserved space      6.84%

 

### Media Information

This window provides your storage device information. In this window you can select which Hard Drive you wish to format (Internal/ External) and just press the **RED** button to format your storage device.

**Formatting will remove all your recordings.**

## Main Menu - Media Manager - File Transfer

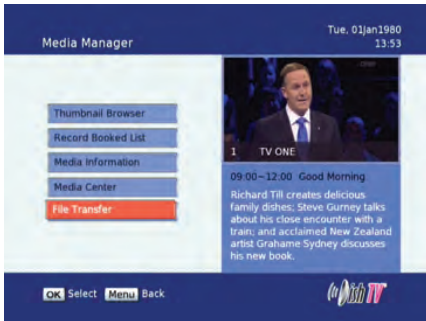

**File Transfer** can be accessed from the Main Menu - Media Manager, where you will see the File Transfer option.

Here you can transfer your recorded programs that you have stored on the internal hard drive of your S7090PVR unit to a removable external USB Hard Drive\* (SATA to USB).

If already copied to the removable external USB Hard Drive\*, it can be transferred back to the internal Hard Drive at a later date (USB to SATA).

Once “File Transfer” is selected you will see two Menu options “SATA to USB” and “USB to SATA”, depending which way you wish to transfer your files. Selecting one will show you a window similar to that on the right...

Here the **RED** button on the remote lets you mark a recording or several recordings. The **GREEN** button on the remote to start the copying process for what you select or the **YELLOW** button to start the moving process for recordings selected.



By pressing the **GREEN** button you will have the choice to copy files over, this will leave the recording on the Drive you are copying from and duplicate it at the new location.

By pressing the **YELLOW** button you will have the choice to move files over, this will remove it from original Drive and shift it over to the other device in the process.



The total copying/ moving time will take a few minutes on average to complete per selected recording. With the status of the transfer shown as a percentage in the transfer window.

Transferring files between “SATA” and “USB”, can only be done with content recorded on the S7090PVR. Alternate files types from outside sources will be unable to be played/ transferred on to the S7090PVR unit. (Excluding JPEG which can be viewed from the USB device in “Photo Viewer”, but not transferred over)



**\*External USB Hard Drive will need to be formatted to FAT32.**

## Main Menu - Media Manager - Media Center - PVR Playback from USB

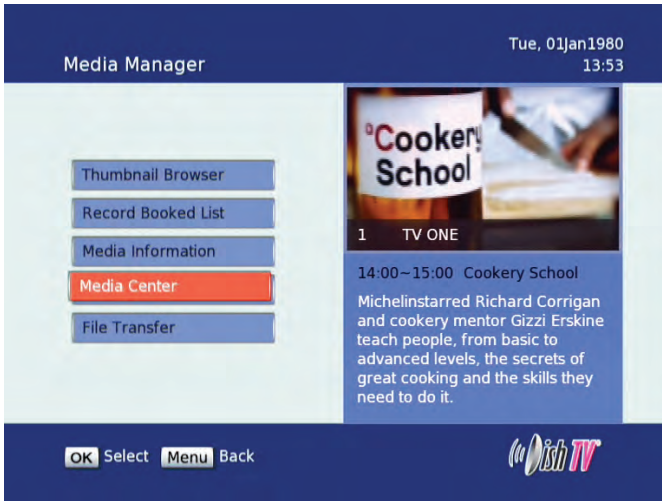

**PVR Playback from USB**, can be accessed from the Main Menu - Media Manager - Media Center - PVR Playback from USB. Here you can view recorded video files you have transferred to an external USB device .

Once PVR Playback from USB is selected, you will see a list which will show your external USB device. Press **OK** to select it and access your videos (**MENU** to go back) you will then see a screen like the one directly below.

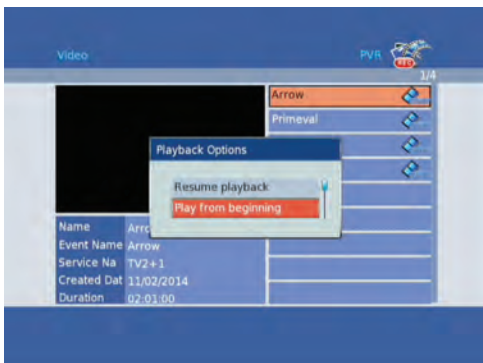
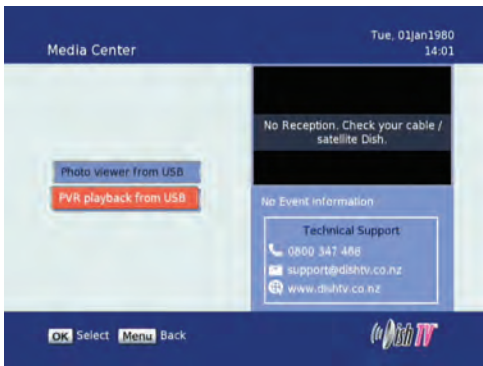

When a Video is selected you will be asked Resume Playback or Play From Beginning (Shown Below) selecting one will then start playback of the recorded content.

Press Stop or Menu to go back to the recording list at any time.

## Main Menu - Common Interface

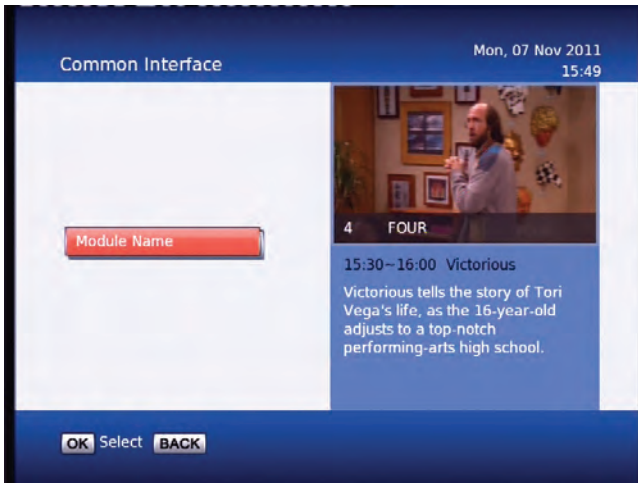

Under this menu you can adjust the settings of your CAM. If this menu is greyed out in the main menu it means you don't have a CAM inserted or the CAM is faulty.

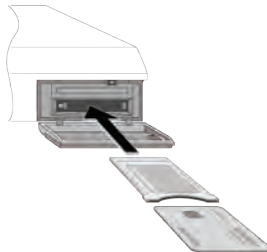

### Common Interface

#### What is common interface?

Some broadcasts are scrambled so that only paid subscribers can enjoy them. Scrambled services can only be viewed with a Conditional Access Module (CAM) and a subscription card belonging with the scrambling system. Common Interface (CI) is the slot on a digital receiver into which a conditional access module may be inserted. To watch a pay service, you should take the following steps:

1. Purchase a conditional access module and a subscription card for the pay service you want to watch.
2. Insert the subscription card into the conditional access module.
3. Insert the conditional access module into the common interface on the front of the digital receiver (Make sure the unit is turned off when doing this).



## Main Menu - Connectivity - eNet Buttons



**eWeather** - Allows you to view the weather conditions for the day. It shows Humidity, Temperature etc.



**eMap** - Allows you to browse and search maps on the internet.

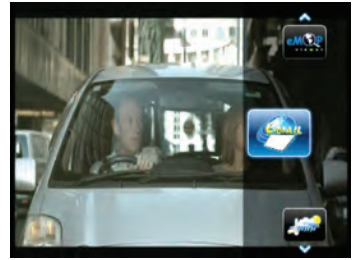

**eMail** - Allows you to log in to your email address, to send/receive messages and view attached files.

**Note:** All of the eNet features require an internet connection via the LAN port on the rear panel of the satBox-ultra. The weather and map services are provided by secondary providers and are not under the control of DishTV. DishTV cannot guarantee the ongoing availability of these free services.

## eNet Buttons - eMap



To check your email on your TV choose **eMail** from the **eNet Buttons menu**.

Use **Up/Down** to navigate between eNet buttons.

Use SMS type keyboard to enter letters. (Entry using number keys)

Type in the area you wish to search and press **OK** for the map to start loading.

Press the **BLUE** button to zoom in on the map, **YELLOW** to zoom out. Press the **Left/Right** button to move the map left and right. Press the **Up/Down** button to move the map up and down.

## eNet Buttons - eWeather



From the **eNet Buttons** menu you can select **eWeather**.  
Use **Up/Down** to navigate between eNet buttons.  
Use SMS type keyboard to enter letters. (Entry using number keys)

Type in the Country you desire and then the closest city name to you.

Press the **OK** button to load the weather page.

Press **Blue** button to change the view between Celsius, Fahrenheit and Kelvin.

Press the **Info** button to toggle between minimum & maximum mode.

## eNet Buttons - eMail

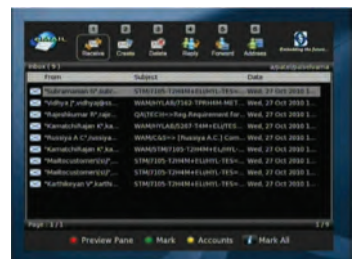
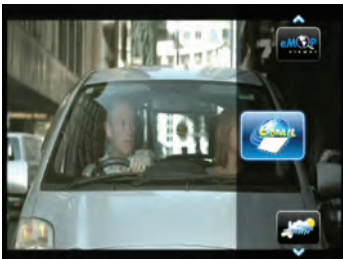

From the **eNet Buttons** menu you can select **eMap**.  
Use **Up/Down** to navigate between eNet buttons.

**Profile Entry** - To keep your email account secure this digital receiver allows multiple secure profiles. The profile has nothing to do with your email login or password. Simply create your own personal profile, which then allows you to keep your email private from other users of this receiver.

- Use the **Green** button to change the keypad mode( uppercase, special characters, numbers ).

- Use the **Info** button to navigate between the different text boxes (like a tab key).

- The **Back** button will exit the keypad mode to allow you to save your profile.

Follow the help bar information for further navigation short cut keys available for quick navigation to create mail, forward mail, reply, address book, etc. Press **Up/Down** button to navigate the different mail headers. If the number of mails is more than 20, mails are split by pages, one page contains 20 messages.

## Recording

**Please note:** This unit has a dual tuner so this means there will be some limitations to what channels you can watch while you are recording. Freeview Satellite has FOUR\* channel groups, when recording two channels you can only watch another channel from the same groups as the one you are recording from. When recording is finished, the other channels will be available again.

See page 32 for channel groups.

\*Channel groups may change at Freeviews discretion.



Pressing the **Red** button on a selected show in the EPG menu will mark the program to be recorded. If the program is part of a series you will have the option of recording the whole series (**Yellow** button) or just this episode (**Blue** button).

### Timer Recordings:

This is done through the EPG. Access the EPG by pressing the **EPG** button (the grey button under the red one) on the remote. It will bring up the guide from which you can then browse to choose a programme to record.



If you want to cancel a recording, all you have to do is go back into the EPG menu, go to the programme you selected for recording and press the **Red** button this will ask you whether you want to cancel the recording or not.

Once you have a recording set you will see a small **R** or **S** to the right hand side of your program. The **R** indicates the program will only be recorded once, the **S** indicates the program will be recorded every time it appears on TV.





## Recording

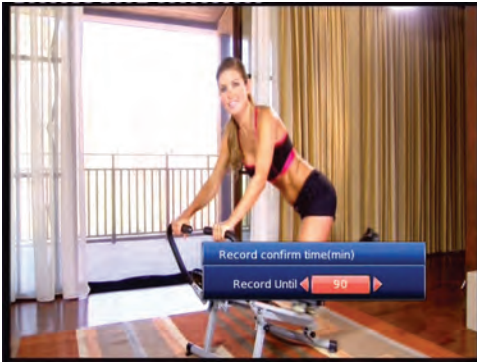

### Instant Record:

This is done by pressing the record button on the remote. (This is the grey button with a red circle on it.)

Pressing it will start recording on the channel you are currently watching and allow you to select the duration of the recording.

The default duration is to the end of the current programme.

You can select to the end of the following programme or manually enter a duration by pressing the left/right navigation keys.

If you press the stop button you will then have the options of renaming and continuing to record, just saving or discarding it.

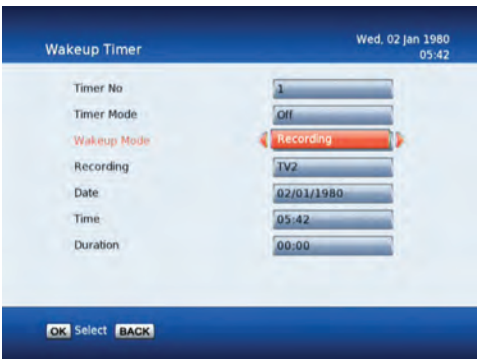

### Wakeup Timer - Recording:

From here you can manually set timer recordings.

This is done through Main Menu/System Configuration/Wakeup Timer.

By going down to the **Wakeup Mode** and scrolling across to **Recording** the options beneath will change to accommodate the new wakeup mode, giving you choices of Channel, Date, Time and Duration.

See page 15 for more info on the wakeup timer.

## Recordings Library



To view recorded programmes, press the Library button.

It will be labeled **LIB** on the remote.

From here you can select the programme you wish to play.

To play a recording press the **OK** button, this will then ask you if you want to play from the beginning or from your last viewed position.

To delete multiple recordings you need to select the recordings you want to remove using the **Yellow** button, then push the **Red** button to delete.

To view booked recordings, Hold down the **LIB** button for 3 seconds while viewing a channel. Or if you are in the library press the **Options** button (**Blue**) and select it in the options list that appears.

From here you can delete bookings, choose to convert to a series recording or not by following on screen instructions.

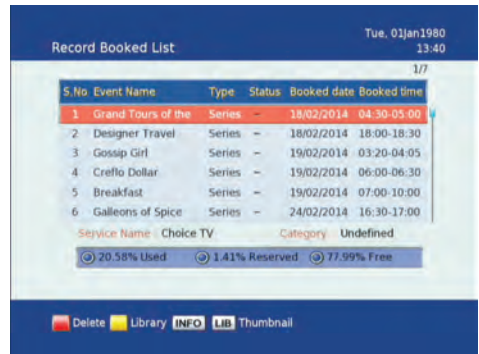

By pressing the Library button (**LIB**) a second time, the Thumbnail browser menu of your video recordings will be opened.

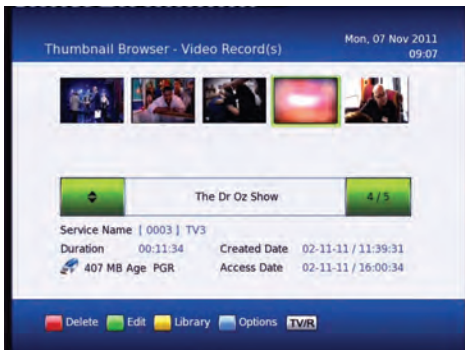

You can also access the Thumbnail Browser in the Main Menu By selecting Media Manager then Thumbnail Browser.

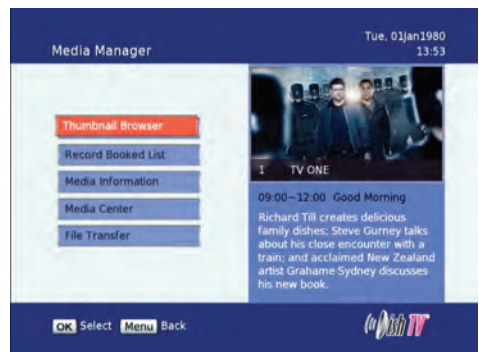

## Bookmarking

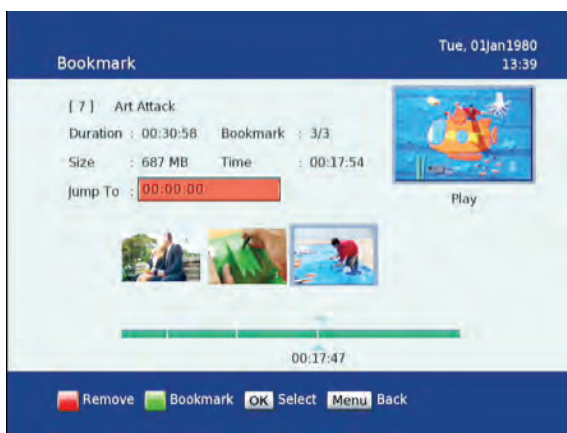

### What is Bookmarking?

You can mark favourite parts of a recording by creating bookmarks, and then jump to them. You can also use bookmarks to skip ads, just place a bookmark at the end of each ad break and when you next play your recording you can easily skip the ads by pressing the **Right Arrow** button next to the **OK** button. Bookmarks are stored with the recordings so that you can use them again afterwards.

To enter the bookmarking window select your recording from the **Library** or **Thumbnail Browser**, then push the **Green** button on your remote then the **OK** button.

You can also set bookmarks when playing back a recording or while watching the programme live at the same time you record it. To do this all you have to do is press the **FAV** button when you wish to set a bookmark and when you next play your recording you can easily skip the ads by pressing the **Right Arrow** button next to the **OK** button. Bookmarks are stored with the recordings so that you can use them again afterwards.

## Editing Recordings

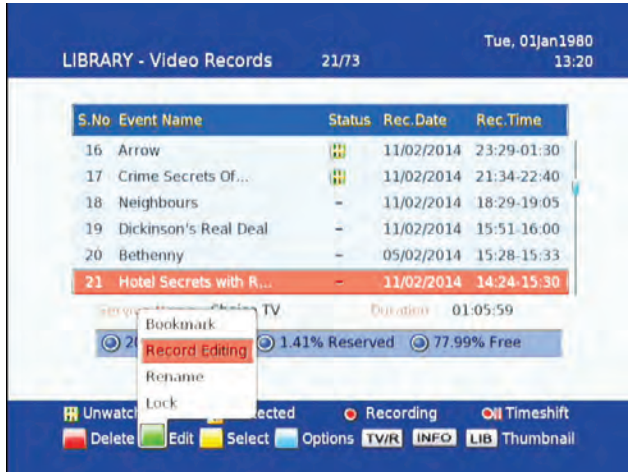

To enter the **Record Edit** window select your recording from the **Library** or **Thumbnail Browser**, then push the **Green** button on your remote then the **OK** button.

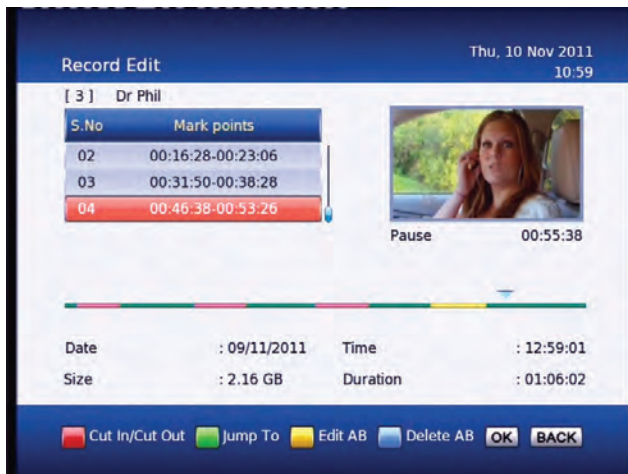

Here you can remove sections of your recordings. In the record edit window your recording will play in the top right of the screen, you can use all your normal play, fast forward, rewind, pause functions to get to where you want to edit. To select an area to delete push the **Red** button to start the selection, and then the **Red** button again to end. If the selection you have made is not quite in the right place you can press the **Yellow** button to edit/move the start of your selection (A) or the end (B). The **Blue** button on your remote will remove the selected section but will not delete that part of your recording. To move between the selections use the **Up/Down** arrows on your remote. Once you are happy with the selections you have made and want to delete these parts from your recording, press the **OK** button and select yes.

## Firmware Upgrade

### Via USB:

One way to perform a firmware upgrade on your receiver is via USB, using the USB connection in the back of your unit. To do this just follow the instructions below... **Note: The USB drive must be formatted to FAT32**

1. Download updated firmware from [www.dishTV.co.nz](http://www.dishTV.co.nz), follow the instructions provided on the website.
2. Turn off power to satBox, insert the flashdrive.
3. Press and hold the **Menu** button on the front of your S7090PVR while powering on the unit, Keep the menu button held down until the unit says USB on the front panel.

The receiver will first display **Load** and if done correctly the display on the front will show **USB** after about 3 seconds. Once **USB** is displayed on the front panel you can release the menu button and leave the unit to do the rest.

On screen at the same time it will present a window headed **Software Update through USB**

If the upgrade has been loaded correctly onto the USB flashdrive it will come up with **SW Image File Reading in progress...** straight after it displays **Searching USB Memory stick...**

Then to a couple of loading screens which will take about 4-5 minutes to complete.

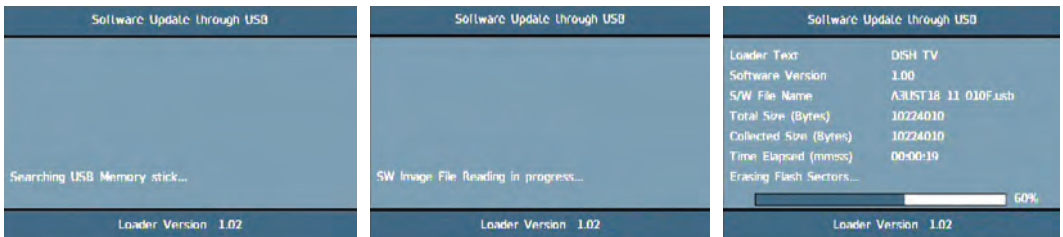

If the firmware upgrade was incorrectly placed on the USB it will also come up with the “Searching USB Memory Stick...” message, the difference is the next message will say “SW Image is not present” it will then quickly display the Flash Verification screen which will last only a few seconds.

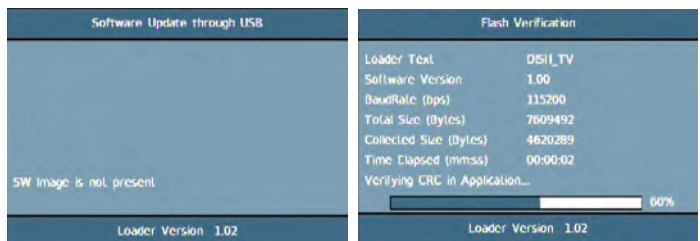

### S/W Upgrade OTA:

This is a Software Upgrade over the air. This will only work if the upgrade is being broadcast. It can be selected from the **Installation** option in the Main Menu. If you leave this set to on your unit will automatically update to new software when its broadcast.

## Frequently Asked Questions

S7090 Satellite PVR– Use with Satellite Dish Only

### Troubleshooting FAQ's

- Q. Why is there a message on the TV saying “No signal”?
- A. This could be due to a faulty LNB or the satellite dish is not aligned correctly, or the coax cable has been damaged (If you are using a dish previously used for SKY the LNB quite likely could be faulty, as these are well known for going faulty)
- Q. Why is the TV picture pixellating (breaking up) while watching live TV, or why can't i get some channels?
- A. It could be due to weak signal which can be caused by:
1. An old LNB that is drifting frequency
  2. The LNB skew is not correct
  3. The Dish is not aligned correctly
  4. Coax cable may be damaged
  5. The signal is split to too many rooms causing the signal to be weak
- Q. Why can't I record a second channel?
- A. The loop cable may not be fitted between tuners at the back. Connect loop cable from **LNB 1 Loop Out** to **LNB 2 Sat In**. Refer to page 6 of this user manual.
- Q. What does LCN mean?
- A. LCN stands for Logical Channel Numbering. This keeps all the channels in the correct order.
- Q. Why is the **Lock** light on?
- A. This is a good thing and indicates your unit is locked to the correct signal.
- Q. Why is my unit not responding to remote / receiver locked up?
- A. Check and replace the batteries in the remote.
- A. A power spike can lock the processor up, power your unit off and on from the wall to make it work again.

Before returning the unit back to your supplier:

1. Do a factory reset by going to MENU>Installation>Factory Reset> Pin 0000. Retune and test again.
2. Check Software version by Clicking MENU>CONFIGURATION>VERSION>SOFTWARE VERSION and check on [www.dishtv.co.nz](http://www.dishtv.co.nz) if not latest please follow the instructions on the web site to update to the latest software version.
3. If problem persists please call Dish TV on 0800 DISH TV (0800 3474 88) or email [support@dishtv.co.nz](mailto:support@dishtv.co.nz)



# Troubleshooting

Problem	Possible Causes	Solution
No picture	<p>S7090PVR is not plugged in or turned on at the wall.</p> <p>Your TV isn't able to display the current Output Format.</p>	<p>Check the front panel. If nothing is illuminated then it is a power issue - please check power socket and plug socket.</p> <p>Please make sure that Main Menu - Installation - System Setting - HD Resolution is set to one that your TV will be able to display. You can view this using the composite output</p>
Remote control is not working	<p>No batteries or batteries incorrectly inserted.</p> <p>Batteries are flat.</p> <p>Infrared receiver on S7090PVR is obstructed.</p>	<p>Insert the supplied 2x AAA batteries as shown on page 7.</p> <p>Insert new batteries as shown on page 7.</p> <p>Check that there is a clear "line of sight" from the remote to the sensor on the front panel.</p>
When recording 1 channel cannot go to another channel	No Signal to second Tuner.	Fit loop cable from LNB1 Out to LNB 2 In
Picture is distorted - too wide or narrow	Wrong TV shape is set.	Go to Main Menu/Installation/System Setting/Aspect Ratio, make sure it is set to match the shape of your display.
No Channels loaded. Database is Empty	<p>This means the unit did not have Signal when a scan was done.</p> <p>Faulty LNB or Dish.</p>	<p>Dish Cable not plugged into LNB in</p> <p>After you have had your dish checked then got to Main Menu/Installation/Factory Default and scan again.</p>



## How to check your signal and quality levels

Push the info button on your remote twice to display the screen to the left. Down the bottom right you will see your signal and quality levels. A normal signal strength is around 80-100% and a normal signal quality level is 70-100%. If your levels are lower than normal and you are having problems you will need to get your dish checked by a satellite technician.

## Technical Specifications

Item	Specification	
Tuner	Frequency Range	950MHz to 2150MHz
	Input Impedance	75Ohms unbalanced
	Signal Input Level	-65 ~ -25dBm
	Symbol Rate	2-45Mbps
	LNB Power	13/18V,Max 500mA
Demodulation	Demodulator	QPSK/8PSK
	FEC	1/2,2/3,3/4,5/6,7/8,8/9,9/10
Connections	LNB IN	F connector
	LOOP OUT	F connector
	YPbPr	Connect to your TV component Input terminals
	L/R	Analog audio L/R signal
	Optical	SPDIF digital audio output
	USB 2.0	For firmware update and external drive use
	HDMI	Connects to HDMI in device
Power	Input	12v DC or 100 - 240V ~ 50/60Hz Via adapter
	Consumption	Max 20W
Display	Decoder Module	PAL,NTSC
	Resolution	720X576(PAL),720X480(NTSC),720P,1080i 480i,480P,576i,576P,1080P
Decoding	Aspect Rate	4:3(Letterbox, Pan& Scan)16:9
	Video	MPEG2 Transport MP@ML.HL
		MPEG4 AVC/H.264 HP@L4
Audio	MPEG2 Audio Layer I&II	
Others	Compliance	DVB-S DVB-S2 compliant
	Sound Mode	Right, Left, Stereo
HDD	Built in 500GB 2.5"	
Dimensions	Width 280mm / Height 60mm / Depth 245mm	

Freeview Satellite Channel Groupings			
Frequency 1	Frequency 2	Frequency 3	Frequency 4
TV3 Four TV3 + 1 Choice TV Cue TV Te Reo Shine TV Parliment TV	TV One TV2 TV One + 1 TV2 + 1 Maori TV	Edge Four + 1	Prime

Channel groups may change at Freeviews discretion.

For more information on limitations regarding recording refer to Page 24



## Warranty

Please keep your receipt as proof of purchase. This product is warranted of any defect in materials or workmanship for one year after the original date of purchase. This product is for normal domestic and office use only. this warranty does not cover damage from misuse or neglect, accidental damage, vermin infestation, excessive voltages such as lightning or power surges or any alteration that affects the performance or reliability of the product.

In the unlikely event that your product fails to work normally please contact your supplier and have your receipt of purchase on hand.

### **This warranty is subject to the following provisions:**

- This is only valid within New Zealand.
- The product must be correctly assembled and operated in accordance with the instructions contained in the manual.
- This product must be used solely for domestic purposes.
- The warranty does not cover accidental damage.
- The warranty will be rendered invalid if the product is resold or has been damaged by inexpert repair.
- The manufacturer disclaims any liability or incidental or consequential damaged.



### **Warranty & Product Registration**

Please register your product to assist with warranty and product updates.  
To do this please visit [www.dishtv.co.nz](http://www.dishtv.co.nz) and click on **Warranty & Registration**