



VFD-F

User Manual

Fan and Pump Applications



Power Range :

1-phase 230V series: 0.75kW~37kW (1~50HP)
3-phase 460V series: 0.75kW~220kW (1~300HP)



DELTA ELECTRONICS, INC.

www.delta.com.tw/industrialautomation

ASIA

Delta Electronics, Inc.

Taoyuan1

31-1, Xingbang Road, Guishan Industrial Zone,
Taoyuan County 33370, Taiwan, R.O.C.
TEL: 886-3-362-6301 / FAX: 886-3-362-7267

Delta Electronics (Jiang Su) Ltd.

Wujiang Plant3

1688 Jiangxing East Road,
Wujiang Economy Development Zone,
Wujiang City, Jiang Su Province,
People's Republic of China (Post code: 215200)
TEL: 86-512-6340-3008 / FAX: 86-512-6340-7290

Delta Electronics (Japan), Inc.

Tokyo Office

Delta Shibadaimon Building, 2-1-14 Shibadaimon,
Minato-Ku, Tokyo, 105-0012, Japan
TEL: 81-3-5733-1111 / FAX: 81-3-5733-1211

Delta Electronics (Korea), Inc.

234-9, Duck Soo BD 7F, Nonhyun-dong,
Kangnam-ku, Seoul, Korea
Post code : 135-010
TEL: 82-2-515-5303/5 / FAX: 82-2-515-5302

Delta Electronics (Singapore) Pte. Ltd.

8 Kaki Bukit Road 2, #04-18 Ruby Warehouse Complex,
Singapore 417841
TEL: 65-6747-5155 / FAX: 65-6744-9228

Delta Energy Systems (India) Pvt. Ltd.

Plot No. 27 & 31, Sector-34, EHTP,
Gurgaon-122001 Haryana, India
TEL: 91-124-4169040 / FAX: 91-124-4036045

AMERICA

Delta Products Corporation (USA)

Raleigh Office

P.O. Box 12173, 5101 Davis Drive,
Research Triangle Park, NC 27709, U.S.A.
TEL: 1-919-767-3813 / FAX: 1-919-767-3969

EUROPE

Deltronics (Netherlands) B.V.

Eindhoven Office

De Witbogt 15, 5652 AG Eindhoven, The Netherlands
TEL: 31-40-259-28-50 / FAX: 31-40-259-28-51

5011613008
200811-26



FE08



VFD-F

User Manual

Fan and Pump Applications

Preface

Thank you for choosing DELTA's high-performance VFD-F Series. VFD-F Series are manufactured by adopting high-quality components, material and incorporating the latest microprocessor technology available.

Getting Started

This manual will be helpful in the installation, parameter setting, troubleshooting, and daily maintenance of the AC motor drives. To guarantee safe operation of the equipment, read the following safety guidelines before connecting power to the AC drives. Keep this operating manual handy and distribute to all users for reference.



WARNING











-  Always read this manual thoroughly before using VFD-F series AC Motor Drives.
-  Ensure that VFD-F is grounded in a correct way before putting it into use.
-  **DANGER!** AC input power must be disconnected before any maintenance. Do not connect or disconnect wires and connectors while power is applied to the circuit. Maintenance must be performed by qualified technicians.
-  **CAUTION!** There are highly sensitive MOS components on the printed circuit boards. These components are especially sensitive to static electricity. To avoid damage to these components, do not touch these components or the circuit boards with metal objects or your bare hands.
-  **DANGER!** A charge may still remain in the DC-link capacitor with hazardous voltages even if the power has been turned off. To avoid personal injury, do not remove the cover of the AC drive until all "DISPLAY LED" lights on the digital keypad are off. Please note that there are live components exposed within the AC drive. Do not touch these live parts.
-  **CAUTION!** Ground the VFD-F using the ground terminal. The grounding method must comply with the laws of the country where the AC drive is to be installed. Refer to Basic Wiring Diagram.
-  **DANGER!** The AC drive may be destroyed beyond repair if incorrect cables are connected to the input/output terminals. Never connect the AC drive output terminals U/T1, V/T2, and W/T3 directly to the AC main circuit power supply.
-  **CAUTION!** The final enclosures of the AC drive must comply with EN50178. (Live parts shall be arranged in enclosures or located behind barriers that meet at least the requirements of the Protective Type IP20. The top surface of the enclosures or barrier that is easily accessible shall meet at least the requirements of the Protective Type IP40). (VFD-F series corresponds with this regulation.)
-  **CAUTION!** The rated voltage for the AC motor drive must be $\leq 240\text{V}$ for 230V models ($\leq 480\text{V}$ for 460V models) and the mains supply current capacity must be $\leq 5000\text{A RMS}$ ($\leq 10000\text{A RMS}$ for the $\geq 40\text{hp}$ (30kW) models)
-  **CAUTION!** Heat sink may heat up over 70°C (158°F), during the operation. Do not touch the heat sink.

TABLE OF CONTENTS

CHAPTER 1 RECEIVING AND INSPECTIONS

1.1 Nameplate Information	1 - 1
1.2 Model Explanation	1 - 1
1.3 Serial Number Explanation.....	1 - 2

CHAPTER 2 STORAGE AND INSTALLATION

2.1 Storage.....	2 - 1
2.2 Installation.....	2 - 2

CHAPTER 3 WIRING

3.1 Basic Wiring Diagram	3 - 2
3.2 External Wiring	3 - 5
3.3 Main Circuit Connection	3 - 6
3.4 Control Terminals.....	3 - 9
3.5 Specifications for Power Terminals and Control Terminals	3-11
3.6 Wiring Notes	3-14
3.7 Motor Operation Precautions	3-16

CHAPTER 4 DIGITAL KEYPAD OPERATION

4.1 VFD-PU01	4 - 2
4.1.1 Description of the Digital Keypad VFD-PU01	4 - 2
4.1.2 Explanation of Display Message.....	4 - 2
4.1.3 Operation Steps of the Digital Keypad VFD-PU01	4 - 4

4.2 KPF-CC01	4 - 5
4.2.1 Description of the Digital Keypad KPF-CC01	4 - 5
4.2.2 Explanation of Display Message.....	4 - 5
4.2.3 KPF-CC01 Operation Flow Chart	4 - 6

CHAPTER 5 DESCRIPTION OF PARAMETER SETTINGS

5.1 Group 0: AC Drive Status Parameters.....	5 - 1
5.2 Group 1: Basic Parameters	5 - 4
5.3 Group 2: Operation Method Parameters.....	5 - 9
5.4 Group 3: Output Function Parameters	5-15
5.5 Group 4: Input Function Parameters.....	5-19
5.6 Group 5: Multi-step Speed Frequency Parameters.....	5-24
5.7 Group 6: Protection Parameters.....	5-30
5.8 Group 7: AC Drive and Motor Parameters	5-36
5.9 Group 8: Special Parameters	5-39
5.10 Group 9: Communication Parameters.....	5-45
5.11 Group 10: PID Control Parameters	5-60
5.12 Group 11: Fan and Pump Control Parameters.....	5-63

CHAPTER 6 MAINTENANCE AND INSPECTIONS

6.1 Periodic Inspection	6 - 1
6.2 Periodic Maintenance	6 - 1

CHAPTER 7 TROUBLESHOOTING AND FAULT INFORMATION..... 7 - 1

CHAPTER 8 SUMMARY OF PARAMETER SETTINGS	8 - 1
--	--------------

APPENDIX A SPECIFICATIONS	A - 1
--	--------------

APPENDIX B ACCESSORIES

B.1 All Brake Resistors & Brake Units Used in AC Motor Drives	B - 1
B.1.1 Dimensions and Weights for Brake Resistors	B - 3
B.1.2 Specifications for Brake Unit	B - 5
B.1.3 Dimensions for Brake Unit.....	B - 6
B.2 AMD-EMI Filter Cross Reference.....	B - 8
B.3 AC Reactor	B-10
B.3.1 AC Input Reactor Recommended Value	B-10
B.3.2 AC Output Reactor Recommended Value.....	B-11
B.4 Non-fuse Circuit Breaker Chart.....	B-12
B.5 Fuse Specification Chart	B-13
B.6 PU06.....	B-14
B.6.1 Description of the Digital Keypad VFD-PU06.....	B-14
B.6.2 Explanation of Display Message	B-14
B.6.3 PU06 Operation Flow Chart	B-15
B.7 Relay Card	B-16
B.8 Zero Phase Reactor	B-18

APPENDIX C DIMENSIONS.....	C - 1
-----------------------------------	--------------

CHAPTER 1 RECEIVING AND INSPECTION

This VFD-F AC drive has gone through rigorous quality control tests at the factory before shipment. After receiving the AC drive, please check for the following:

Receiving

- ✓ Check to make sure that the package includes an AC drive, the User Manual, dust covers and rubber bushings.
- ✓ Inspect the unit to insure it was not damaged during shipment.
- ✓ Make sure that the part number indicated on the nameplate corresponds with the part number of your order.

1.1 Nameplate Information: Example for 7.5HP/5.5kW 3-phase 460V AC drive

AC Drive Model	▶	MODEL : VFD055F43A
Input Spec.	▶	INPUT : 3PH 380-480V 50/60Hz 14A
Output Spec.	▶	OUTPUT : 3PH 0-480V 13A 9.9KVA 7.5HP
Output Frequency Range	▶	Frequency Range : 1.5-120Hz
Enclosure type	▶	Enclosure: TYPE 1
Serial Number & Bar Code	▶	 055F43AT201001

DELTA ELECTRONICS INC. MADE IN XXXXX

1.2 Model Explanation

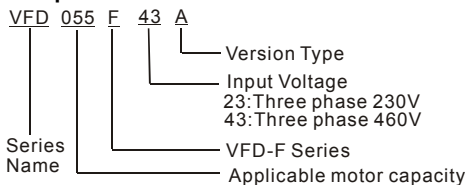

007: 1.0HP(0.75kW)	150: 20HP(15kW)	750: 100HP(75kW)
015: 2.0HP(1.5kW)	185: 25 HP(18.5kW)	900: 120HP(90kW)
022: 3.0HP(2.2kW)	220: 30 HP(22kW)	1100: 150HP(110kW)
037: 5.0HP(3.7kW)	300: 40HP(30kW)	1320: 175HP(130kW)
055: 7.5HP(5.5kW)	370: 50HP(37kW)	1600: 215HP(160kW)
075: 10 HP(7.5kW)	450: 60HP(45kW)	1850: 250HP(185kW)
110: 15 HP(11kW)	550: 75HP(55kW)	2200: 300HP(220kW)

1.3 Series Number Explanation

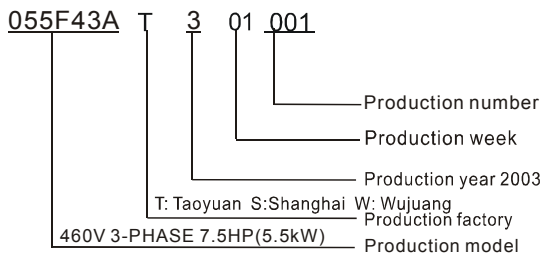

If there is any nameplate information not corresponding to your purchase order or any problem, please contact your distributor.

CHAPTER 2 STORAGE AND INSTALLATION

2.1 Storage

The AC drive should be kept in the shipping carton before installation. In order to retain the warranty coverage, the AC drive should be stored properly when it is not to be used for an extended period of time.

Ambient Conditions:

Operation	Air Temperature: -10°C to $+40^{\circ}\text{C}$ (14°F to 104°F) $+50^{\circ}\text{C}$ (122°F) without dust cover. Atmosphere pressure: 86 to 106 kPa Installation Site Altitude: below 1000m Vibration: Maximum 9.80 m/s^2 (1G) at less than 20Hz Maximum 5.88 m/s^2 (0.6G) at 20Hz to 50Hz
Storage	Temperature: -20°C to $+60^{\circ}\text{C}$ (-4°F to 140°F) Relative Humidity: Less than 90%, no condensation allowed Atmosphere pressure: 86 to 106 kPa
Transportation	Temperature: -20°C to $+60^{\circ}\text{C}$ (-4°F to 140°F) Relative Humidity: Less than 90%, no condensation allowed Atmosphere pressure: 86 to 106 kPa Vibration: Maximum 9.86 m/s^2 (1G) at less than 20Hz, Maximum 5.88 m/s^2 (0.6G) at 20Hz to 50Hz
Pollution Degree	2: good for a factory type environment.

2.2 Installation



CAUTION

The control, power supply and motor leads must be laid separately. They must not be fed through the same cable conduit / trunking.

High voltage insulation test equipment must not be used on cables connected to the drive.

Improper installation of the AC drive will greatly reduce its life. Be sure to observe the following precautions when selecting a mounting location.

Failure to observe these precautions may void the warranty!

- Do not mount the AC drive near heat-radiating elements or in direct sunlight.
- Do not install the AC drive in a place subjected to high temperature, high humidity, excessive vibration, corrosive gases or liquids, or airborne dust or metallic particles.
- Mount the AC drive vertically and do not restrict the air flow to the heat sink fins.
- The AC drive generates heat. Allow sufficient space around the unit for heat dissipation.

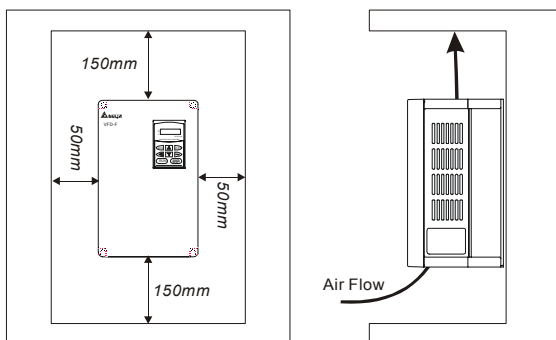

CHAPTER 3 WIRING



DANGER

Hazardous Voltage

Before accessing the AC drive:

- Disconnect all power to the AC drive.
- Wait five minutes for DC bus capacitors discharge.

3

Any electrical or mechanical modification to this equipment without prior written consent of Delta Electronics, Inc. will void all warranties and may result in a safety hazard in addition to voiding the UL listing.

Short Circuit Withstand:

The rated voltage for the AC motor drive must be $\leq 240\text{V}$ for 230V models ($\leq 480\text{V}$ for 460V models) and the mains supply current capacity must be $\leq 5000\text{A RMS}$ ($\leq 10000\text{A RMS}$ for the $\geq 40\text{hp}$ (30kW) models)

3.1 Basic Wiring Diagram

Users must connect wires according to the following circuit diagram shown below. Do not plug a Modem or telephone line to the RS-485 communication port, permanent damage may result. Pins 1 & 2 are the power sources for the optional copy keypad and should not be used while using RS-485 communication.

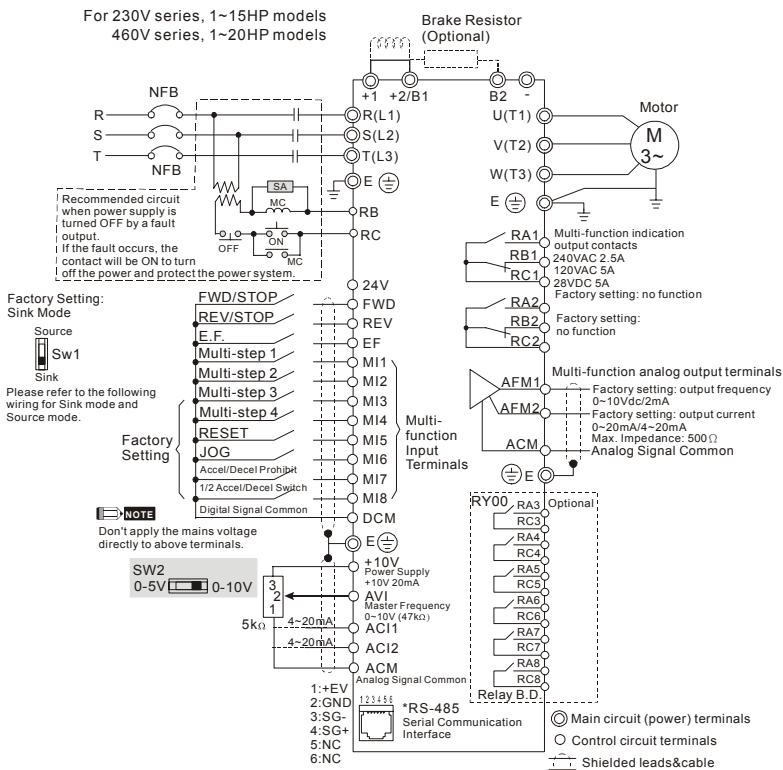

For 230V series, 20HP and above models
460V series, 25HP and above models

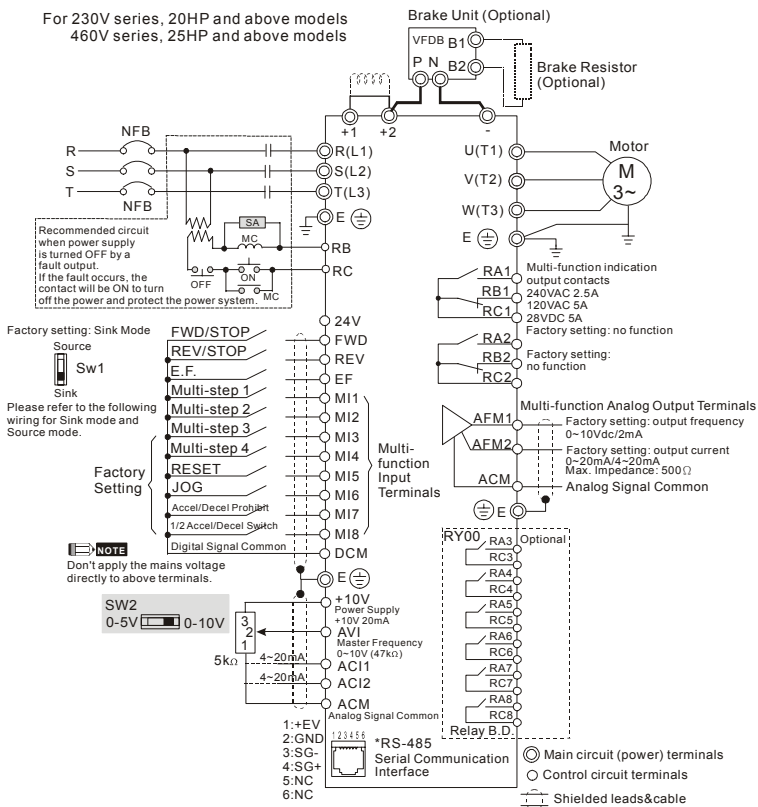

3

Wiring for SINK mode and SOURCE mode

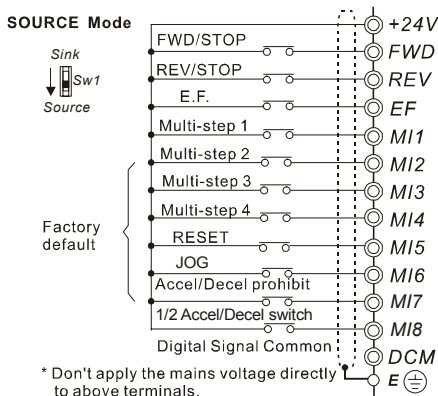
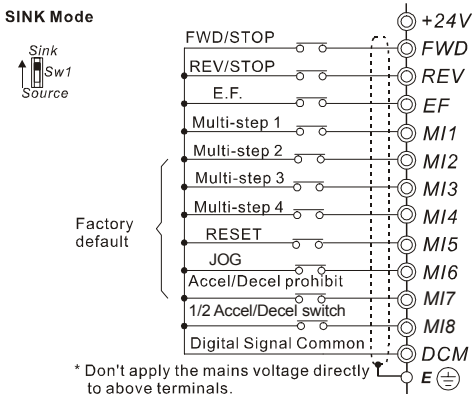

3.2 External Wiring

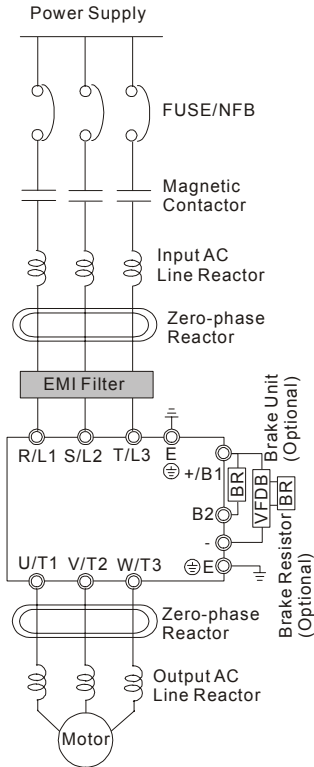

Items	Explanations
Power supply	Please follow the specific power supply requirements shown in Appendix A.
Fuse/NFB (Optional)	There may be an inrush current during power up. Please check the chart of Appendix B and select the correct fuse with rated current. Use of an NFB is optional.
Magnetic contactor (Optional)	Please do not use a Magnetic contactor as the I/O switch of the AC motor drive, as it will reduce the operating life cycle of the AC drive.
Input AC Line Reactor (Optional)	Used to improve the input power factor, to reduce harmonics and provide protection from AC line disturbances (surges, switching spikes, short interruptions, etc.). AC line reactor should be installed when the power supply capacity is 500kVA or more or advanced capacity is activated. The wiring distance should be $\leq 10m$. Refer to appendix B for details.
Zero-phase Reactor (Optional)	Zero-phase reactors are used to reduce radio noise especially when audio equipment is installed near the inverter. Effective for noise reduction on both the input and output sides. Attenuation quality is good for a wide range from AM band to 10MHz. Appendix B specifies the zero-phase reactor. (RF220X00A)
EMI filter (Optional)	To reduce electromagnetic interference, please refer to Appendix B for more details.
Brake Resistor (Optional)	Used to reduce the deceleration time of the motor. Please refer to the chart in Appendix B for specific Brake Resistors.
Output AC Line Reactor (Optional)	Motor surge voltage amplitude depends on motor cable length. For applications with long motor cable (>20m), it is necessary to install a reactor at the inverter output side.

3

3.3 Main Circuit Connection

Figure 1 for the main circuit terminals

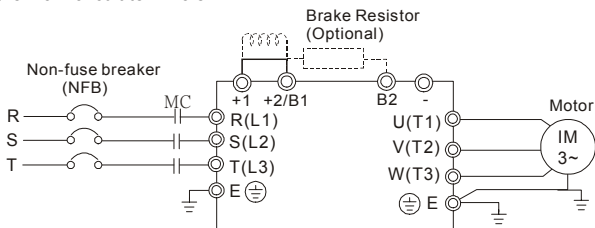
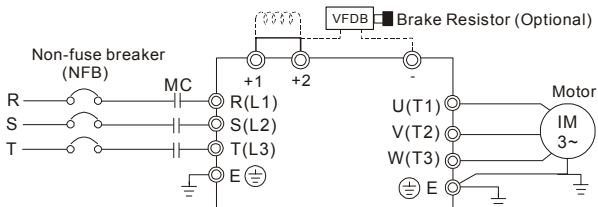

Figure 2 for the main circuit terminals



Terminal Explanations

Terminal Symbol	Explanation of Terminal Function
R/L1, S/L2, T/L3	AC line input terminals
U/T1, V/T2, W/T3	AC drive output terminals motor connections
+1,+2	Connections for DC Link Reactor (optional)
+2/B1~B2	Connections for Brake Resistor (optional)
+2~ -,+2/B1~ -	Connections for External Brake Unit (VFDB series)
	Earth Ground

Mains power terminals (R/L1, S/L2, T/L3)

- Connect these terminals (R/L1, S/L2, T/L3) via a non-fuse breaker or earth leakage breaker to 3-phase AC power (some models to 1-phase AC power) for circuit protection. It is unnecessary to consider phase-sequence.
- It is recommended to add a magnetic contactor (MC) in the power input wiring to cut off power quickly and reduce malfunction when activating the protection function of AC motor drives. Both ends of the MC should have an R-C surge absorber.
- Please make sure to fasten the screw of the main circuit terminals to prevent sparks which is made by the loose screws due to vibration.
- Please use voltage and current within the regulation shown in Appendix A.
- When using a general GFCI (Ground Fault Circuit Interrupter), select a current sensor with sensitivity of 200mA or above, and not less than 0.1-second detection time to avoid nuisance tripping. For the specific GFCI of the AC motor drive, please select a current sensor with sensitivity of 30mA or above.
- Do NOT run/stop AC motor drives by turning the power ON/OFF. Run/stop AC motor drives by RUN/STOP command via control terminals or keypad. If you still need to run/stop AC drives by turning power ON/OFF, it is recommended to do so only ONCE per hour.
- Do NOT connect 3-phase models to a 1-phase power source.

Output terminals for main circuit (U, V, W)

- If the AC drive is installed in the place where a load reactor is needed, install the filter close to U/T1, V/T2, W/T3 side of AC drive. Do not use a Capacitor or L-C Filter (Inductance-Capacitance) or R-C Filter (Resistance-Capacitance), unless approved by Delta.
- DO NOT connect phase-compensation capacitors or surge absorbers at the output terminals of AC motor drives.
- Use well-insulated motor, suitable for inverter operation.

Terminals [+1, +2] for connecting DC reactor

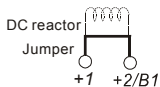

- To improve power factor and reduce harmonics, connect a DC reactor between terminals [+1, +2]. Please remove the jumper before connecting the DC reactor.

Terminals [+2/B1, B2] for connecting brake resistor and terminals [+2/B1, -] for connecting external brake unit

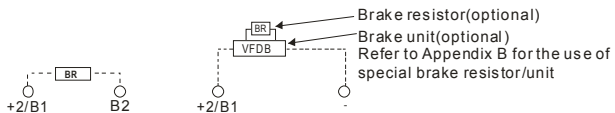

- Connect a brake resistor or brake unit in applications with frequent deceleration ramps, short deceleration time, too low brake torque or requiring increased brake torque.
- If the AC motor drive has a built-in brake chopper, connect the external brake resistor to the terminals [+2/B1, B2].
- Some models of VFD-F series don't have a built-in brake chopper, please connect an external optional brake unit and brake resistor.
- When not used, please leave the terminals [+2(+2/B1), -] open.



Short-circuiting [B2] or [-] to [+2/B1] can damage the AC motor drive.

3.4 Control Terminals

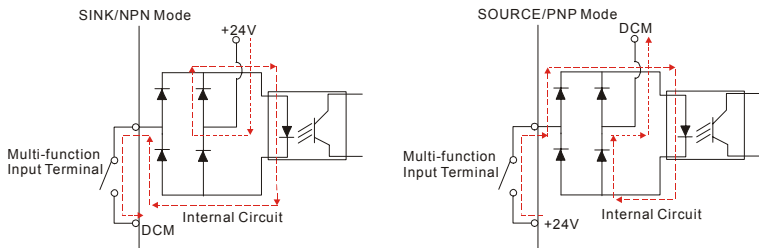

3

Terminal symbols and functions

Terminal Symbols	Terminal Functions	Factory Settings
FWD	Forward-Stop command	
REV	Reverse-Stop command	
EF	External fault	
MI1	Multi-function Input 1	Factory setting: Multi-step speed command 1
MI2	Multi-function Input 2	Factory setting: Multi-step speed command 2
MI3	Multi-function Input 3	Factory setting: Multi-step speed command 3
MI4	Multi-function Input 4	Factory setting: Multi-step speed command 4
MI5	Multi-function Input 5	Factory setting: RESET
MI6	Multi-function Input 6	Factory setting: JOG
MI7	Multi-function Input 7	Factory setting: Accel/Decel prohibit
MI8	Multi-function Input 8	Factory setting: Accel/Decel time switch 1
+24V	DC Voltage Source	(+24V, 20mA), used for source mode.
DCM	Digital Signal Common	Used as common for digital inputs and used for sink mode.
RA 1	Multi-function Relay1 output (N.O.) a	1.5A(N.O.)/1A(N.C.) 240VAC 1.5A(N.O.)/1A(N.C.) 24VDC Refer to Pr.03-00 to Pr.03-01
RB 1	Multi-function Relay1 output (N.C.) b	
RC 1	Multi-function Relay1 common	
RA 2	Multi-function Relay2 output (N.O.) a	
RB 2	Multi-function Relay2 output (N.C.) b	
RC 2	Multi-function Relay2 common	

Terminal Symbols	Terminal Functions	Factory Settings
+10V	Potentiometer power source	+10V 20mA
AVI	Analog voltage Input	0 to +10V correspond to Max. operation frequency
ACI 1/2	Analog current Input	4 to 20mA correspond to Max. operation frequency
AFM 1	Analog frequency /current meter 1	0 to 10V correspond to Max. operation frequency
AFM 2	Analog frequency /current meter 2	4 to 20mA correspond to 2 times of output current
ACM	Analog control signal (common)	

* Control signal wiring size: 18 AWG (0.75 mm²).

Analog input terminals (ACI1, ACI2, ACM)

- Analog input signals are easily affected by external noise. Use shielded wiring and keep it as short as possible (<20m) with proper grounding. If the noise is inductive, connecting the shield to terminal ACM can bring improvement.
- If the analog input signals are affected by noise from the AC motor drive, please connect a capacitor and ferrite core as indicated in the following diagrams:

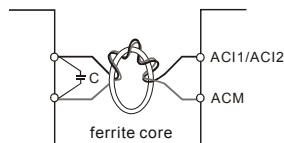

wind each wire 3 times or more around the core

Digital inputs (FWD, REV, MI1~MI8, DCM)

- When using contacts or switches to control the digital inputs, please use high quality components to avoid contact bounce.

3.5 Specifications for Power Terminals and Control Terminals

Frame B

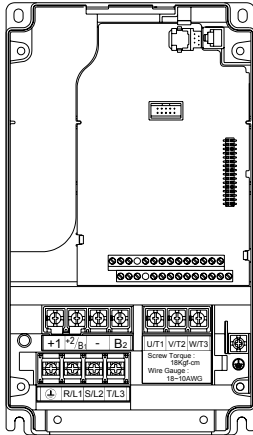

Power Terminals:

R/L1, S/L2, T/L3, U/T1, V/T2, W/T3, \oplus , +1, +2/B1, -, B2

Models	Wire Gauge	Torque	Wire Type
VFD007F23A	12-24 AWG (3.3-0.2mm ²)	18kgf-cm (15.6in-lbf)	Stranded Copper only, 75°C
VFD007F43A			
VFD007F43H			
VFD015F23A			
VFD015F43A			
VFD015F43H			
VFD022F23A			
VFD022F43A			
VFD022F43H			
VFD037F23A			
VFD037F43A			
VFD037F43H			

Control Terminals:

Wire Gauge	Torque
12-24AWG. (3.3-0.2mm ²)	4kgf-cm (3in-lbf)

Frame C

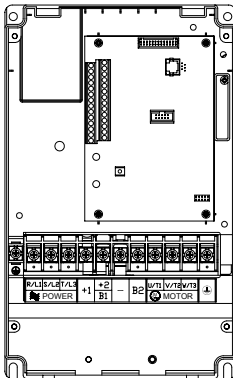

Power Terminals:

R/L1, S/L2, T/L3, U/T1, V/T2, W/T3, \oplus , +1, +2/B1, -, B2

Models	Wire Gauge	Torque	Wire Type
VFD055F23A	12-8 AWG, (3.3-8.4mm ²)	30kgf-cm (26in-lbf)	Stranded Copper only, 75°C
VFD055F43B			
VFD055F43H			
VFD075F23A			
VFD075F43B			
VFD075F43H			
VFD110F23A			
VFD110F43A			
VFD110F43H			
VFD150F43A			
VFD150F43H			

NOTE

If wiring of the terminal utilizes the wire with a diameter of 6AWG.(13.3mm²), it is thus necessary to use the Recognized Ring Terminal to conduct a proper wiring.

Control Terminals:

Wire Gauge	Torque
12-24AWG. (3.3-0.2mm ²)	4kgf-cm (3in-lbf)

Frame D

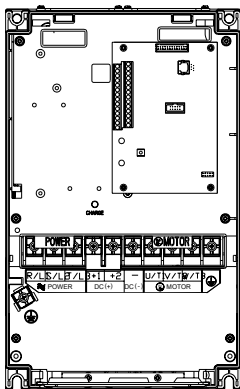

Power Terminals:

R/L1, S/L2, T/L3, U/T1, V/T2, W/T3, ⊕, +1, +2, -,

Models	Wire Gauge	Torque	Wire Type
VFD150F23A	8-2 AWG. (8.4-33.6mm ²)	30kgf-cm (26in-lbf)	Stranded Copper only, 75°C
VFD185F23A			
VFD185F43A			
VFD185F43H			
VFD220F23A			
VFD220F43A			
VFD220F43H			
VFD300F43A			
VFD300F43H			

NOTE

If wiring of the terminal utilizes the wire with a diameter of 1AWG.(42.4mm²), it is thus necessary to use the Recognized Ring Terminal to conduct a proper wiring.

Control Terminals:

Wire Gauge	Torque
12-24AWG. (3.3-0.2mm ²)	4kgf-cm (3in-lbf)

Frame E

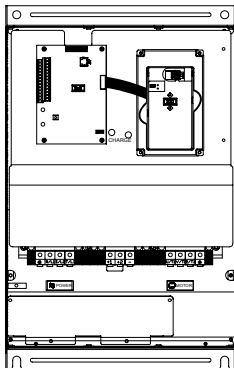

Power Terminals:

R/L1, S/L2, T/L3, U/T1, V/T2, W/T3, ⊕, +1, +2, -,

Models	Wire Gauge	Torque	Wire Type
VFD300F23A	1/0-4/0 AWG. (53.5-107.2mm ²)	200kgf-cm (173in-lbf)	Stranded Copper only, 75°C
VFD370F23A	3/0-4/0 AWG. (85-107.2mm ²)		
VFD750F43A			
VFD750F43H			
VFD900F43C	4/0 AWG. (107.2mm ²)	57kgf-cm (49.5in-lbf)	
VFD370F43A	3 AWG. (26.7mm ²)		
VFD370F43H			
VFD450F43A	2 AWG. (33.6mm ²)	200kgf-cm (173in-lbf)	
VFD450F43H			
VFD550F43A	1/0-4/0 AWG. (53.5-107.2mm ²)		
VFD550F43H			

Control Terminals:

Wire Gauge	Torque
12-24AWG. (3.3-0.2mm ²)	4kgf-cm (3in-lbf)

Frame G

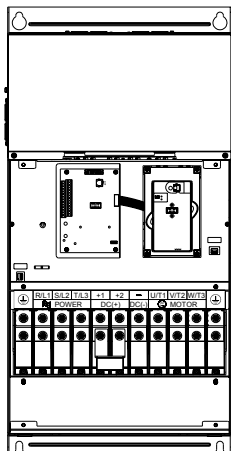

Power Terminals:

R/L1, S/L2, T/L3, U/T1, V/T2, W/T3, ⊕, +1, +2, -,

Models	Wire Gauge	Torque	Wire Type
VFD1100F43C	4/0 AWG - 300MCM (107.2-152mm ²)	300kgf-cm (260in-lbf)	Stranded Copper only, 75°C
VFD1100F43H			
VFD1320F43A			
VFD1320F43H			
VFD1600F43A			
VFD1600F43H			

NOTE

It needs following additional terminal when wiring, and add insulation sheath on position where following figure shows.

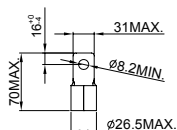

Control Terminals:

Wire Gauge	Torque
12-24AWG. (3.3-0.2mm ²)	4kgf-cm (3in-lbf)

Frame H

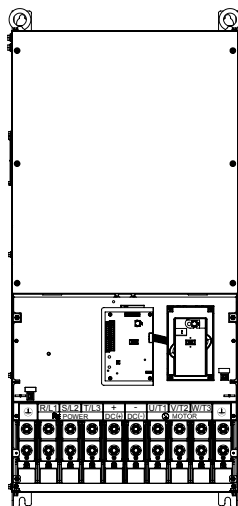

Power Terminals:

R/L1, S/L2, T/L3, U/T1, V/T2, W/T3, ⊕, +1, -,

Models	Wire Gauge	Torque	Wire Type
VFD1850F43A	500 MCM (max)	408kgf-cm (354 in-lbf)	Stranded copper only, 75°C
VFD1850F43H			
VFD2200F43A			
VFD2200F43H			

NOTE

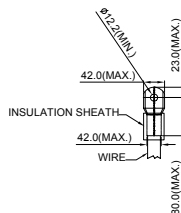

It needs following additional terminal when wiring, and add insulation sheath on position where following figure shows.



Control Terminals:

Wire Gauge	Torque
12-24AWG. (3.3-0.2mm ²)	4kgf-cm (3in-lbf)

3.6 Wiring Notes: PLEASE READ PRIOR TO INSTALLATION.

1.  **CAUTION:** Do not connect the AC power to the U/T1, V/T2, W/T3 terminals, as it will damage the AC drive.
2.  **WARNING:** Ensure all screws are tightened to the proper torque rating.
3. During installation, follow all local electrical, construction, and safety codes for the country the drive is to be installed in.
4. Ensure that the appropriate protective devices (circuit breaker or fuses) are connected between the power supply and AC drive.
5. Make sure that the leads are connected correctly and the AC drive is properly grounded. (Ground resistance should not exceed 0.1Ω .)
6. Use ground leads that comply with AWG/MCM standards and keep them as short as possible.
7. Multiple VFD-F units can be installed in one location. All the units should be grounded directly to a common ground terminal. The VFD-F ground terminals may also be connected in parallel, as shown in the figure below. **Ensure there are no ground loops.**

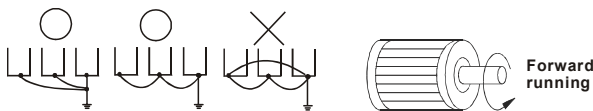

8. When the AC drive output terminals U/T1, V/T2, and W/T3 are connected to the motor terminals U, V, and W, respectively, the motor will rotate counterclockwise (as viewed from the shaft ends of the motor) when a forward operation command is received. To reverse the direction of motor rotation, switch over any of the two motor leads.
9. Make sure that the power source is capable of supplying the correct voltage and required current to the AC drive.
10. Do not attach or remove wiring when power is applied to the AC drive.
11. Do not inspect components unless inside "CHARGE" lamp is turned off.
12. Do not monitor the signals on the circuit board while the AC drive is in operation.

13. For the single-phase rated AC drives, the AC power can be connected to any two of the three input terminals R/L1, S/L2, T/L3. **Note: This drive is not intended for the use with single-phase motors.**
14. Route the power and control wires separately, or at 90° angle to each other.
15. If a filter is required for reducing EMI (Electro Magnetic Interference), install it as close as possible to AC drive. EMI can also be reduced by lowering the Carrier Frequency.
16. If the AC drive is installed in the place where a load reactor is needed, install the filter close to U/T1, V/T2, W/T3, side of AC drive. Do not use a Capacitor or L-C Filter (Inductance-Capacitance) or R-C Filter (Resistance-Capacitance), unless approved by Delta.
17. When using a general GFCI (Ground Fault Circuit Interrupter), select a current sensor with sensitivity of 200mA or above, and not less than 0.1-second detection time to avoid nuisance tripping. For the specific GFCI of the AC motor drive, please select a current sensor with sensitivity of 30mA or above.
18. To improve the input power factor, to reduce harmonics and provide protection from AC line disturbances (surges, switching spikes, short interruptions, etc.), AC line reactor should be installed when the power supply capacity is 500kVA or more.
19. There are highly sensitive MOS components on the printed circuit boards. These components are especially sensitive to static electricity. To prevent damage to these components, do not touch these components or the circuit boards with metal objects or your bare hands.

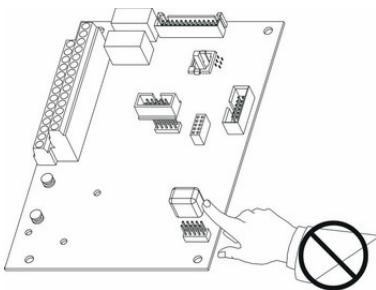

3.7 Motor Operation Precautions

1. When using the AC drive to operate a standard 3-phase induction motor, notice that the energy loss is greater than for an inverter duty motor.
2. Avoid running a standard induction motor at low speed. Under these conditions, the motor temperature may rise above the motor rating due to limited airflow produced by the motor's fan.
3. When the standard motor operates at low speed, the output load must be decreased.
4. If 100% output torque is desired at low speed, it may be necessary to use a special "inverter-duty" rated motor.

CHAPTER 4 DIGITAL KEYPAD OPERATION

This chapter describes the various controls and indicators found on the digital keypad. The information in this chapter should be read and understood before performing the start-up procedures described in the chapter of parameter settings.

- ↳ Description of the Keypad
- ↳ Description of Display
- ↳ Keypad Operation Modes & Programming Steps





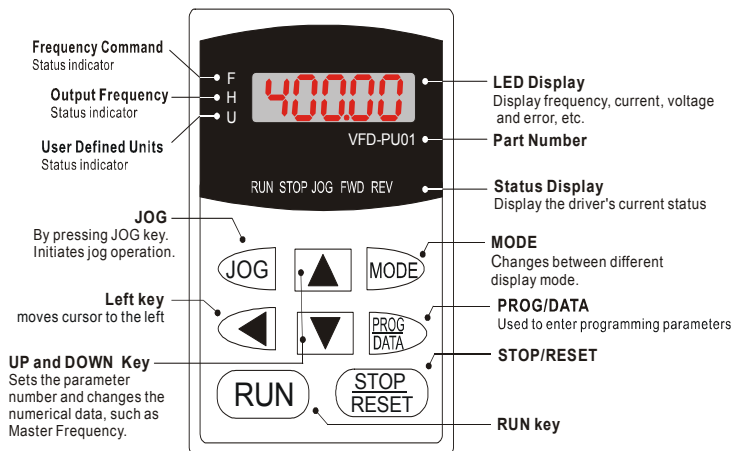



4.1 VFD-PU01

4.1.1 Description of the Digital Keypad VFD-PU01



4.1.2 Explanation of Display Message

Display Message	Descriptions
	Display the AC drive Master Frequency.
	Display the actual operation frequency present at terminals U/T1, V/T2, and W/T3.
	Display voltage (V), Current (A), power factor and feedback signal (P)
	Display the output current present at terminals U/T1, V/T2, and W/T3.

Display Message	Descriptions
	Display the AC drive forward run status.
	The AC drive reverse run status.
	Display the specified parameter setting.
	Display the actual value stored within the specified parameter.
	External Fault.
	Display "End" for approximately 1 second if input has been accepted. After a parameter value has been set, the new value is automatically stored in memory. To modify an entry, use the  or  keys.
	Display "Err", if the input is invalid.

4.1.3 Operation steps of the Digital Keypad VFD-PU01

Selecting mode

START



Note : In the selection mode, press **PROG DATA** to set the parameters.

Setting parameters

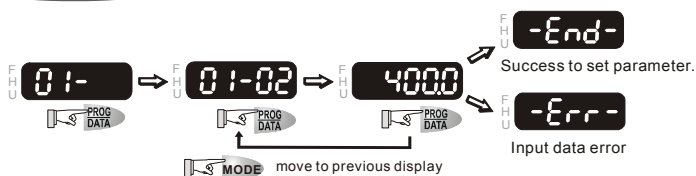

NOTE :In the parameter setting mode, you can press **MODE** to return the selecting mode.

To shift data

START



To modify data

START



Setting direction



4.2 KPF-CC01

For models of VFD-F (HVAC) series

VFD007F43H; VFD015F43H; VFD022F43H; VFD037F43H; VFD055F43H; VFD075F43H;
 VFD110F43H; VFD150F43H; VFD185F43H; VFD220F43H; VFD300F43H; VFD370F43H;
 VFD450F43H; VFD550F43H; VFD750F43H; VFD900F43H; VFD1100F43H; VFD1320F43H;
 VFD1600F43H; VFD1850F43H; VFD2200F43H

NOTE

When KPF-CC01 is connected on AC motor drive, the communication protocol is forced to be 9600, 8, N, 2. After KPF-CC01 is disconnected, and AC motor drive immediately gets connection with other controller by RS-485, 1st communication fault may occur due to different communication protocol. AC motor drive will automatically reset communication protocol as previous parameter setting from 2nd communication.

4

4.2.1 Description of the Digital Keypad KPF-CC01

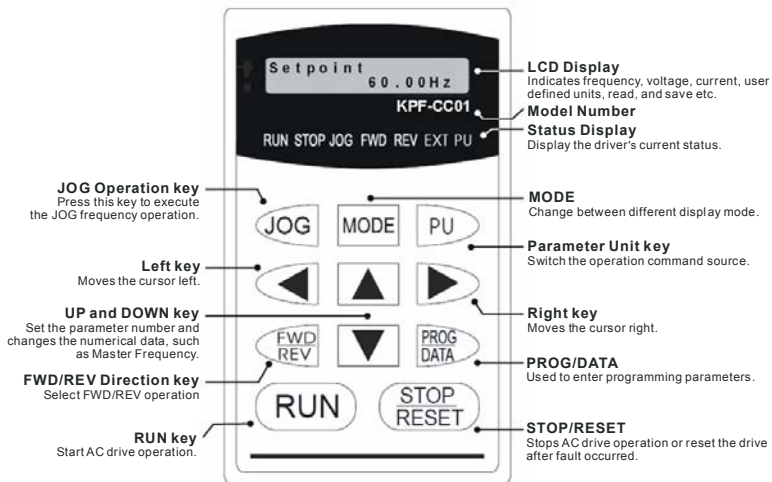

4.2.2 Explanation of Display Message

Display Message	Description
	The AC motor drive Master Frequency Command.
	The Actual Operation Frequency present at terminals U, V, W.

Display Message	Description
Load current 0.0 Amp	The output current present at terminals U, V, W.
Basic P01.00=	The specified group description.
Max Voltage Freq P01.01= 60.00Hz	The specified parameter description and setting
Read Block 1 -Empty Address-	Copy Mode: Press MODE key for about 2~3 seconds in main page. Use UP/DOWN key to select copy function (Read, Write, Delete) and LEFT/RIGHT key to select memory address. Total two blocks are available.
Copy to KeyPad? <Block 1> No	Use UP/DOWN key to confirm copy function. Press PROG/DATA key to execute.
External Fault	External Fault.
Value Accepted	Input data is accepted.
Invalid Data	Input data is invalid.

4.2.3 KPF-CC01 Operation Flow Chart

KPF-CC01 Operation Flow Chart

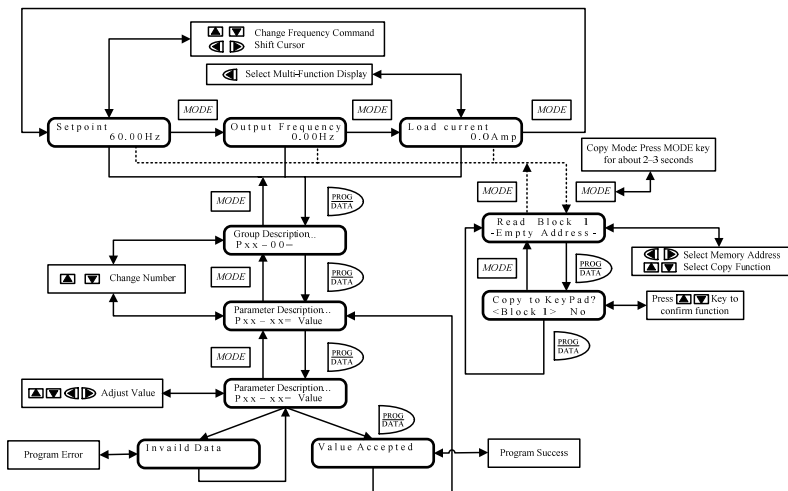

CHAPTER 5 DESCRIPTION OF PARAMETER SETTINGS

↗: This parameter can be set during operation.

5.1 Group 0: AC Drive Status Parameters

🔒 Group 0 is read-only.

00 - 00 Software Version Factory setting: Read Only

🔒 This parameter displays the software version of AC drive.

00 - 01 AC Drive Status Indication 1 Factory setting: Read Only

🔒 This parameter displays the AC drive status.

Code	AC Drive Status	Explanation
00	No fault occurred	
01	oc	over current
02	ov	over voltage
03	oH	over temperature
04	oL	overload
05	oL1	electronic thermal relay
06	EF (external fault)	EF-DCM is closed
07	occ (AC drive IGBT fault)	IGBT short circuit protection
08	cF3 (CPU failure)	Abnormal A/D reading during self-check
09	HPF (hardware protection failure)	Hardware protection function activated during self-check.
10	ocA (over current during acceleration)	Output current exceeds protection level during acceleration
11	ocd (over current during deceleration)	Output current exceeds protection level during deceleration
12	ocn (over current during steady state operation)	Output current exceeds protection level during steady state operation.
13	GFF (ground fault)	Ground fault protection feature activated
14	Lv (under voltage)	Low input voltage
15	cF1	EEPROM input data is abnormal
16	cF2	EEPROM output data is abnormal
17	bb (base block)	BB is set and activated
18	oL2 (motor over load 2)	Output current exceeds rated motor current
19	Reserved	
20	codE	software or password protection
21	EF1 (external emergency stop)	EF1 (a multifunction-DCM is enabled)
22	PHL (phase loss)	Input power lacks phase. 3-phase input power is unbalance and exceeds specification.
23	Lc (Low Current)	Low current detection during operation.
24	FbL(Feedback Loss)	Feedback signal is abnormal.
25	Reserved	

Code	AC Drive Status	Explanation
26	FAnP	Fan Power Fault
27	FF1	Fan 1 Fault
28	FF2	Fan 2 Fault
29	FF3	Fan 3 Fault
30	FF123	Fan 1, 2, 3 Fault
31	FF12	Fan 1, 2 Fault
32	FF13	Fan 1, 3 Fault
33	FF23	Fan 2, 3 Fault
34	Fv	Gate Drive Low Voltage Protect

00 - 02	AC Drive Status Indication 2	Factory setting: Read Only
Display	<p>Bit 0~1: 00: Run LED is off and STOP led is on. (AC Drive stopping) 01: Run LED is blink and STOP led is on. (AC Drive deceleration to stop) 10: Run LED is on and STOP led is blink. (AC Drive standby) 11: Run LED is on and STOP led is off. (AC Drive running)</p> <p>Bit 2: 1: Jog on.</p> <p>Bit 3~4: 00: Rev LED is off and FWD led is on. (Forward) 01: Rev LED is blink and FWD led is on. (Reverse to Forward) 10: Rev LED is on and FWD led is blink. (Forward to Reverse) 11: Rev LED is on and FWD led is off. (Reverse)</p> <p>Bit 5-7: Reserved Bit 8: Master frequency source via communication interface Bit 9: Master frequency source via analog Bit10: Running command via communication interface Bit11: Parameter locked Bit12~15: Reserved</p>	

00 - 03	Frequency Setting	Factory setting: Read Only
	This parameter displays the frequency command set by the user.	

00 - 04	Output Frequency	Factory setting: Read Only
	This parameter displays actual output frequency of the AC drive.	

00 - 05	Output Current	Factory setting: Read Only
	This parameter displays actual output current of the AC drive.	

00 - 06	DC-BUS Voltage	Factory setting: Read Only
	This parameter displays DC-BUS voltage of the AC drive.	

00 - 07	Output Voltage	Factory setting: Read Only
	This parameter displays output voltage of the AC drive.	

00 - 08	Output Power Factor	Factory setting: Read Only
---------	---------------------	----------------------------

 This parameter displays output power factor.

00 - 09	Output Power (kW)	Factory setting: Read Only
----------------	-------------------	----------------------------

 This parameter displays output power of the AC drive.

00 - 10	Feedback Signal Actual Value	Factory setting: Read Only
----------------	------------------------------	----------------------------

 This parameter displays feedback signal value.

00 - 11	Feedback Signal (%)	Factory setting: Read Only
----------------	---------------------	----------------------------

 This parameter displays feedback signal value (%).

00 - 12	User Target Value (Low bit) uL 0-99.99	Factory setting: Read Only
----------------	--	----------------------------

00 - 13	User Target Value (High bit) uH 0-9999	Factory setting: Read Only
----------------	--	----------------------------

 User Target Value = Actual output frequency (0-04) × User Defined Multiplier (02-10).

 Maximum summed display of both parameters is 999999.99.

 When User Target Value ≤ 99.99, 00-13=0.

00 - 14	PLC time	Factory setting: Read Only
----------------	----------	----------------------------

 This parameter displays remaining time of PLC each phase.

5.2 Group 1: Basic Parameters

01 - 00	Maximum Output Frequency	Factory Setting: 60.00
----------------	---------------------------------	-------------------------------

Settings 50.00~120.00Hz

 This parameter determines the AC drives maximum output frequency. All master frequency commands set by the keypad or analog inputs are limited by this parameter. The analog commands (AVI, ACI1 and ACI2) may be scaled to correspond to the output frequency range. (Please refer to 04-09~04-20.)

01 - 01	Maximum Voltage Frequency (Base Frequency)	Factory Setting: 60.00
----------------	---	-------------------------------

Settings 0.10~120.00 Hz

 This parameter sets the frequency, where the maximum output voltage (Pr. 01-02) will be reached. The output frequency may exceed this setting, but the output voltage doesn't increase beyond this point. This parameter should be set according to the rated frequency of the motor as indicated on the motor nameplate.

 If this parameter setting is smaller than the rated frequency of the motor, nuisance over current faults or damage to the AC drive may occur.

 If this parameter setting is greater than the rated frequency of the motor, the motor will encounter torque loss.

01 - 02	Maximum Output Voltage	Factory Setting: 220.0/440.0
----------------	-------------------------------	-------------------------------------

Settings 230V series: 0.1 ~ 255.0V
 460V series: 0.2 ~ 510.0V

 This parameter determines the Maximum Output Voltage of the AC drive. This parameter setting should be set according to rated voltage of the motor as indicated on the motor nameplate. If rated voltage of the motor is 440V, this parameter must be set to 440V. If rated voltage of the motor is 380V, this parameter must be set to 380V.

 If this setting is greater than the rated voltage of the motor, nuisance over current faults or damage to the AC drive may occur.

01 - 03	Mid-point Frequency	Factory Setting: 1.50
----------------	----------------------------	------------------------------

Settings 0.10~120.00 Hz

 This parameter sets the Mid-point Frequency of the V/f curve.

 This parameter must meet the following argument. Pr.1-01 >= Pr.1-03 >= Pr.1-05.

01 - 04 Mid-point Voltage Factory Setting: 5.5/11.0

Settings 230V series: 0.1 ~ 255.0V
 460V series: 0.2 ~ 510.0V

 This parameter sets the Mid-point Voltage of the V/f curve.

 This parameter must meet the following argument. Pr.1-02 >= Pr.1-04 >= Pr.1-06.

01 - 05 Minimum Output Frequency Factory Setting: 1.50

Settings 0.10~20.00 Hz

 This parameter sets the Minimum Output Frequency of the AC drive. This parameter must be lower than or equal to the Mid-point frequency

01 - 06 Minimum Output Voltage Factory Setting: 5.5/11.0

Settings 230V series: 0.1 ~ 50.0V
 460V series: 0.2 ~ 100.0V

 This parameter sets the Minimum Output Voltage of the AC Drive. The parameter must be lower than or equal to the Mid-point Voltage.

01 - 07 Upper Bound Frequency Factory Setting: 60.00

Settings 0.00~120.00 Hz

 This parameter will limit the maximum output frequency of AC drive. If slip compensation (Pr.07-02~07-05) or feedback control (Pr.10-00~10-09) are enabled, the output frequency of AC drive may exceed the Master Frequency Command, but it will continue to be limited by this parameter setting.

01 - 08 Lower Bound Frequency Factory Setting: 0.00

Settings 0.00~120.00 Hz

 This parameter will limit the minimum output frequency. Any Master Frequency Command below Pr.1-08, will result in an output equal to Pr.1-08.

 Upon a start command, the drive will accelerate from Pr.1-05 Minimum Output Frequency to the Master Frequency Command point.

 The Lower Bound Frequency setting must be smaller than the Dwell Frequency (Pr.11-08>=01-08). If lower bound frequency setting is greater than the Dwell Frequency, the AC drive will equalize the two settings to the Lower Bound point.

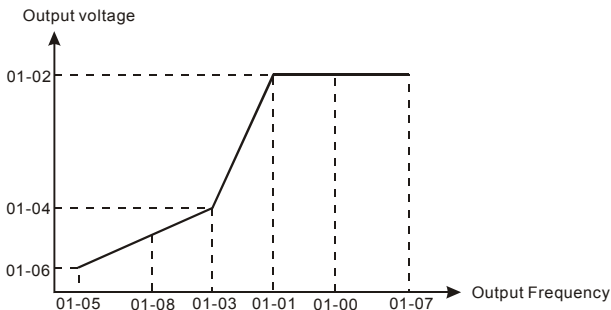

01 - 09	Acceleration Time 1	✓	Factory Setting: 10.0/60.0
01 - 10	Deceleration Time 1	✓	Factory Setting: 10.0/60.0
01 - 11	Acceleration Time 2	✓	Factory Setting: 10.0/60.0
01 - 12	Deceleration Time 2	✓	Factory Setting: 10.0/60.0
01 - 13	Acceleration Time 3	✓	Factory Setting: 10.0/60.0
01 - 14	Deceleration Time 3	✓	Factory Setting: 10.0/60.0
01 - 15	Acceleration Time 4	✓	Factory Setting: 10.0/60.0
01 - 16	Deceleration Time 4	✓	Factory Setting: 10.0/60.0
01 - 17	JOG Acceleration Time	✓	Factory Setting: 10.0/60.0
01 - 18	JOG Deceleration Time	✓	Factory Setting: 10.0/60.0

Settings 0.1~3600.0 Sec

Unit: 0.1sec

- Acceleration time is the time required for the AC drive to ramp from 0 Hz to its Maximum Output Frequency (Pr.1-00). Deceleration time is the time required for the AC drive to decelerate from Maximum Output Frequency (Pr.1-00) down to 0 Hz.
- An Acceleration or Deceleration time that is too quick, may cause the AC drives protection features to enable (over-current stall prevention during Accel 06-01 or over-voltage stall prevention 06-00). If this occurs, the actual Accel/Decel time will be longer than this setting.
- Warning: An acceleration or deceleration that is too quick, may cause excess loads on the AC drive and may permanently damage the drive.
- If you want to decelerate the AC drive in short time period, we recommend to add an external brake module and brake resistor.
- You can set 1st to 4th Accel/Decel time via multi-function input terminals 04-00 to 04-07.

01 - 19	JOG Frequency	↗	Factory Setting: 6.00
----------------	----------------------	---	-----------------------

Settings 0.0 Hz~120.00 Hz

Unit: 0.1sec

 When the JOG function is to be utilized, users need to use the multi-function input terminals (Pr. 04-00 to 04-07 set to 07) or the JOG key on keypad. Once a JOG command is initiated, the AC drive will accelerate from the Minimum Output Frequency (Pr.01-05) to the JOG frequency (Pr.01-19).

 The accel/decel time of the JOG operation is determined by the JOG accel/decel speed (Pr.01-17 and 01-18).

 When the drive is in operation, the JOG command is disabled.

01 - 20	S Curve Delay Time in Accel		Factory Setting: 0.00
----------------	------------------------------------	--	-----------------------

01 - 21	S Curve Delay Time in Decel		
----------------	------------------------------------	--	--

Settings 0.00~2.50sec

 These parameters enable the S curve. The longer the S curve time period the smoother the transition between speeds.

01 - 22	Modulation Index	↗	Factory Setting: 1.00
----------------	-------------------------	---	-----------------------

Settings 0.90~1.20

Unit: 0.1

 This parameter sets the ratio of the Maximum Output Voltage to the input voltage.

 The Maximum Output Voltage (Pr.01-02) is normally limited to the input voltage. With the Modulation Index parameter, the user is able to increase the output voltage beyond the incoming line voltage.

 A Modulation Index of 1, defines the Maximum Output Voltage (Pr. 1-02) is equal to the input voltage.

 A Modulation index of 1.2, defines the Maximum Output Voltage (Pr. 1-02) is 20% higher than in the input voltage. Please note, the output voltage wave form will be distorted due to harmonics and may increase torque ripple and noise in the motor.

01 - 23	Accel/Decel Time Unit		Factory Setting: 01
----------------	------------------------------	--	---------------------

Settings 00: Unit is 1 Sec

01: Unit is 0.1 Sec

02: Unit is 0.01 Sec

 This parameter sets the resolution of accel/decel time (Pr.01-09 to 01-18).

 A high resolution decreases the accel/decel time range as shown in the following chart.

01-23	Accel/Decel time unit	Accel/Decel time range
00	1 Sec	1~36000 Sec
01	0.1 Sec	0.1~3600.0 Sec
02	0.01 Sec	0.01~360.00 Sec

5.3 Group 2: Operation Method Parameters

02 - 00	Source of Frequency Command	↗	Factory Setting: 00
Settings			
00: via keypad			
01: via analog input AVI			
02: via analog input ACI1			
03: via analog input ACI2			
04: via RS485 serial communication			
05: via External Reference			

Settings:

00: Frequency command source is the keypad. User may use UP/DOWN keys to adjust the frequency command. Also if the Multi-Function Input terminals (Pr.04-00 to 04-07) are set to 13 or 14, their function will be the same as the UP/DOWN keys.

01: Frequency command source is the analog input terminal AVI.

02: Frequency command source is the analog input terminal ACI1.

03: Frequency command source is the analog input terminal ACI2.

04: Frequency command source is the RS485 serial communication.

05: Frequency command source depends on the setting of Pr. 04-24.

 You may use SW2 on the control board to choose between a 0~10V or 0~5V input range. When AVI is set to 0~5V, the voltage input is limited to 5V maximum. The relationship to frequency is 0V = 0hz and 5V = Pr1-00.

02 - 01	Source of Operation Command	↗	Factory Setting: 00
Settings			
00: Controlled by the digital keypad			
01: Controlled by the external terminals, keypad STOP enabled.			
02: Controlled by the external terminals, keypad STOP disabled.			
03: Controlled by the RS-485 communication interface, keypad STOP enabled.			
04: Controlled by the RS-485 communication interface, keypad STOP disabled.			

 This parameter sets the operation command source of the AC drive.

 When the AC drive is controlled by an external source, you may select 2-wire or 3-wire operation. Please refer to Pr.02-05.

Settings 00: Stop = ramp to stop, E.F. (External Fault) = coast to stop

01: Stop = coast to stop, E.F. = coast to stop

02: Stop = ramp to stop, E.F. = ramp to stop

03: Stop = coast to stop, E.F. = ramp to stop

Ramp: The AC drive decelerates the motor to minimum output frequency according to the deceleration time setting.

Coast: The AC drive output instantly stops upon command and the motor free spins until it comes to a complete stop.

External Fault may be enabled by the EF terminal or a Multi-Function terminal. Please refer to Pr.04-00 to 04-07.

Loss of an ACI signal may cause an E.F. condition. Please refer to 02-07.

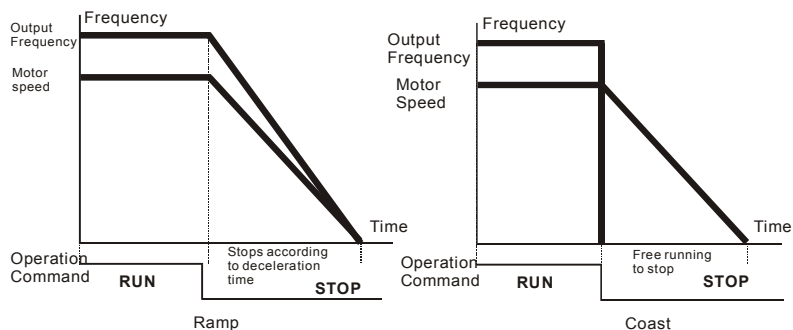
02 - 03 PWM Carrier Frequency Selections

Unit: 1

Settings 1~10HP 4000~10000Hz

Factory Setting: 9000Hz

15~30HP 3000~9000Hz

Factory Setting: 6000Hz

≥40HP 2000~6000Hz

Factory Setting: 4000Hz

This parameter sets the carrier frequency of PWM output. The factory setting and setting range depend on the model type.

When the temperature of the heat sink is greater than its limit, the AC drive will automatic lower the carrier frequency to avoid over heating the AC drive.

The Carrier frequency of the PWM output has a significant influence on the electromagnetic noise, heat dissipation of the AC drive, and the acoustic noise to the motor as shown in the following chart.

Carrier frequency	Acoustic Noise	Electromagnetic Noise	Leakage Current	Heat Dissipation
Signification	Minimal	Signification	Signification	Signification
↓	↓	↓	↓	↓
Minimal	Signification	Minimal	Minimal	Minimal

When the carrier frequency is low, current ripple of the AC drive is large. This may result in a current display value greater than the actual value.

02 - 04 Forward/Reverse Enable Factory Setting: 00

- Settings
- 00: Forward/Reverse enabled
 - 01: Reverse disabled
 - 02: Forward disabled

This parameter enables the direction of the AC drive.

02 - 05 2-wire/3-wire Operation Control Modes Factory Setting: 00

- Settings
- 00: 2-wire (#1), FWD/STOP, REV/STOP
 - 01: 2-wire (#2), RUN/STOP, REV/FWD
 - 02: 3-wire

This parameter sets the operation mode when operating by external terminals.

Please refer to 02-01.

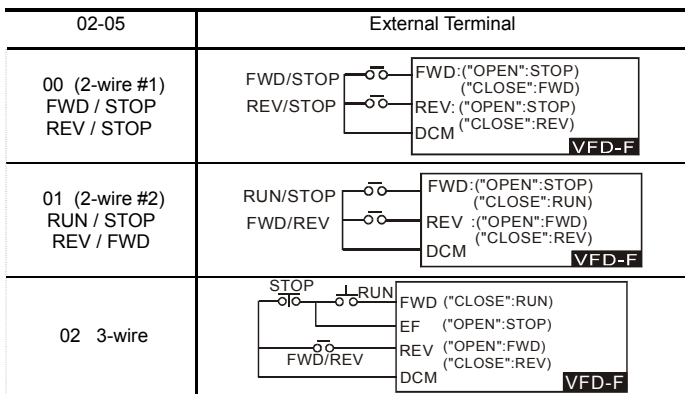

02 - 06	Line Start Lockout	Factory Setting: 01
----------------	---------------------------	---------------------

Settings 00: Disabled
 01: Enabled

-  When enabled, the AC drive will not start when powered up with a run command applied. The AC drive must see the run command transition from stop to run after power up. When Line Start Lockout is disabled (also known as Auto-Start), the AC drive will start when powered-up with run commands applied.





02 - 07	Loss of ACI Signal	Factory Setting: 01
----------------	---------------------------	---------------------





Settings 00: Decelerate to 0Hz
 01: E.F.
 02: Continue operation by the last frequency command

-  This parameter determines the AC drives response to a loss of the ACI input.

02 - 08	Start-up Display Selection	↗	Factory Setting: 00
----------------	-----------------------------------	---	---------------------

Settings Bit0~1: 00 = F LED
 01 = H LED
 10 = U LED (special display)
 11 = Fwd / Rev
 Bit2: 0 = Fwd LED / 1 = Rev LED
 Bit3~5: 000 = 1st 7-step
 001 = 2nd 7-step
 010 = 3rd 7-step
 011 = 4th 7-step
 100 = 5th 7-step
 Bit6~7: Reserved

-  This parameter determines the display on keypad after each power up.
-  To program this parameter the user must first generate a Hex value with the information above. Then using the Hex to Decimal conversion to find the corresponding Decimal value and enter it into this parameter.
-  For example, a setting of 21 (decimal 21= hex 010101) will display the "H" and "REV" LEDs and the cursor will stay at the 3rd 7-step display upon power up.
-  When setting to U LED, please refer to 02-09.

-  If this parameter is set to 00: The AC drive will not store the last known master frequency command, after power is removed.
-  If this parameter is set to 01: The AC drive will memorize the last known master frequency command after power off. Upon power up the last known frequency is displayed.
-  After a fault, the AC drive will always remember the last know master frequency command.
-  This feature is only enabled when Pr. 02-00 is set for 0 or 4.

5.4 Group 3: Output Function Parameters

03 - 00	Multi-function Output terminal 1	Factory Setting: 00
03 - 01	Multi-function Output terminal 2	Factory Setting: 00
03 - 02	Multi-function Output terminal 3	Factory Setting: 00
03 - 03	Multi-function Output terminal 4	Factory Setting: 00
03 - 04	Multi-function Output terminal 5	Factory Setting: 00
03 - 05	Multi-function Output terminal 6	Factory Setting: 00
03 - 06	Multi-function Output terminal 7	Factory Setting: 00
03 - 07	Multi-function Output terminal 8	Factory Setting: 00
Settings		00-33

Setting	Functions	Descriptions
00	No function	
01	Motor No. 1	When starting circulative control, AC drive will automatic set this parameter by 11-01 to 11-03.
02	Motor No. 2	
03	Motor No. 3	
04	Motor No. 4	
05	Motor No. 5	
06	Motor No. 6	
07	Motor No. 7	
08	Motor No. 8	
09	Auxiliary 1 output	Parameter value 09 to 15 program Multi-Function Output Terminals (Pr.03-00~Pr.03-07) to correspond with the AC drive multi-function input terminals, Pr.04-00 to 04-07(settings 20~26).
10	Auxiliary 2 output	
11	Auxiliary 3 output	
12	Auxiliary 4 output	
13	Auxiliary 5 output	
14	Auxiliary 6 output	
15	Auxiliary 7 output	
16	Indication during operation	The corresponding output will be closed during operation (including DC brake time).
17	Master frequency attained	The corresponding output will be closed when output frequency reaches master frequency command.
18	Zero Speed (including shutdown)	The corresponding output will be closed when the AC drive has no output voltage signal.
19	Over-torque	The corresponding output relay will be closed when the AC drives output current exceeds the over-torque detection level 06-04.
20	External Fault	The corresponding output will be closed when the EF is enabled. (Pr. 4-00 to 4-07)

Setting	Functions	Descriptions
21	Low voltage detection	The corresponding output will be closed when the DC Bus voltage drops below our threshold. The keypad will display "Lu".
22	Operation Mode indication	The corresponding output will be closed when the AC drives "Operation Command" is controlled by the external terminals.
23	Fault Indication	The corresponding output will be closed when AC drive has experienced a fault.
24	Master Frequency Attained 1	The corresponding output will be closed when the AC drives output frequency exceeds (Pr.03-08) Master Frequency Attained 1.
25	Master Frequency Attained 2	The corresponding output will be closed when the AC drives output frequency exceeds (Pr.03-09) Master Frequency Attained 2.
26	Over Temperature indication	The corresponding output will be closed when the AC drive temperature exceeds its rating.
27	Drive Ready	The corresponding output will be closed the when the AC drive is ready and has no faults.
28	External Emergency Stop (EF1)	The corresponding output will be closed when multi-function input terminals (Pr.04-00 to 04-07) are set to emergency stop and then activated.
29	Software brake output	The corresponding output will be closed when the AC drives DC bus voltage exceeds (Pr.08-19) the brake level.
30	OL or OL1 overload warning	The corresponding output will be closed upon an overload (OL or OL1) fault.
31	Dwell indication (sleep)	The corresponding output will be closed when the AC drive is in a Dwell status (Pr.11-07).
32	Low current indication	The corresponding output will be closed when the AC drives output current is lower than the Low Current setting (Pr.06-08).
33	PID feedback error indication	The corresponding output will be closed when the PID feedback signal has an error.
34	PLC Program Running	The Output will be activated when PLC Program is running.
35	PLC Program Step Completed	The Output will be activated for 0.5 sec when each multi-step speed is attained.
36	PLC Program Completed	The output will be activated for 0.5 sec when the PLC program cycle has completed
37	PLC Operation Paused	The output will be activated when PLC operation is paused.

 The VFD-F has two form C relays (multi-function output 1 and 2). There is an optional External Relay Card with 6 NO contact relays (multi-function outputs 3-8).

External relay specifications = 8A/250VAC or 5A/30VDC.

Relay delay time is 5~10 msec.

03 - 08	Master Frequency Attained 1	Factory Setting: 0.00
03 - 09	Master Frequency Attained 2	

Settings 0.00~120.00 Hz Unit: 0.01

An output relay may be programmed to activate when the output frequency exceeds the desired attained frequency setting of these two parameters.

There is a $\pm 2\text{Hz}$ window of operation. If the master frequency attained is 20Hz and the output frequency exceeds 20Hz, the corresponding output relay will be “closed”. When the output frequency is less than 18Hz, the corresponding output relay will be “opened” as the following diagram shows.

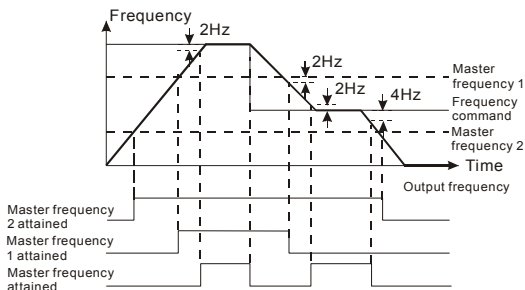

03 - 10	Analog Output 1, (AFM1) 0~10Vdc	Factory Setting: 00
03 - 11	Analog Output 2, (AFM2) 0/4~ 20mA	Factory Setting: 01

Settings 00: Output frequency
 01: Output current
 02: Output voltage
 03: Frequency command
 04: Power factor loading

These parameters select the content of the analog output signals AFM1 and AFM2.

Setting 00: 0-10V = 0 - (Pr.01-00)

Setting 01: 0-10V = 0 - (2.52.0 x rated current)

Setting 02: 0-10V = 0 - (Pr.01-02)

Setting 03: 0-10V = 0 - Master Freq. command

Setting 04: 0-10V = 0.0 - output power factor 1.0

When using 0-20mA output, please refer to Pr. 3-14.

Maximum impedance loading of analog output 2 (AFM2) can't be greater than 500 ohms.

03 - 12	Analog Output Gain 1	↗	Factory Setting: 100
03 - 13	Analog Output Gain 2		Factory Setting: 100
	Settings	01~200%	

This parameter is to determine analog output gain.

The analog output is limited to 10V and 20mA. The gain is designed to offer a normally small output signal to be enlarged for easier viewing on a meter.

03 - 14	Analog Output 2 Selection	Factory Setting: 01
	Settings	00: 0~20mA 01: 4~20mA

This parameter selects the output range of Analog Output 2 (AFM2).

03 - 15	DC Fan Control	Factory Setting: 00
	Settings	00: Fan runs on power up. 01: Fan begins upon a RUN command. Fan stops 1 minute after a STOP command. 02: Fan begins upon a RUN command. Fan stops after a STOP command 03: Fan is controlled by temperature. Approximately a 60°C temperature will start the fan.

This parameter determines DC fan control method.

5.5 Group 4: Input Function Parameters

04 - 00	Multi-function Input terminal 1	Factory Setting: 01
04 - 01	Multi-function Input terminal 2	Factory Setting: 02
04 - 02	Multi-function Input terminal 3	Factory Setting: 03
04 - 03	Multi-function Input terminal 4	Factory Setting: 04
04 - 04	Multi-function Input terminal 5	Factory Setting: 05
04 - 05	Multi-function Input terminal 6	Factory Setting: 07
04 - 06	Multi-function Input terminal 7	Factory Setting: 08
04 - 07	Multi-function Input terminal 8	Factory Setting: 09
Settings 00~31		

Setting	Functions	Descriptions
00	No function	All unused terminals should be set to 00, to assure they have no effect on drive operation.
01	Multi-Speed terminal 1	Allows selection of the 15 multi-step speeds. Please refer to 05-00 to 05-14 to program the 15 step speeds.
02	Multi-Speed terminal 2	
03	Multi-Speed terminal 3	
04	Multi-Speed terminal 4	
05	Reset (NO)	Clears (Reset) a fault and returns the AC drive to normal operation.
06	Reset (NC)	
07	Jog operation (JOG)	Enables the JOG command. Works identical to the JOG key on the digital keypad.
08	Accel/Decel disable	Stops the acceleration or deceleration of the AC drive. AC drive then maintains a constant speed.
09	Accel/Decel 2 selection	A corresponding terminal set to value 09 and closed selects Accel/Decel time 2. A corresponding terminal set to value 10 and closed selects Accel/Decel time 3. Accel/Decel time 4 is selected when both terminals are closed.
10	Accel/Decel 3 selection	
11	B.B. (NO) input	Enables the base block (pause) function. Please refer to Pr.08-08, for base block functions.
12	B.B. (NC) input	
13	Increase Frequency	Enables the external terminals to increase or decrease the Master Frequency command each time an input is received. Terminals are not active during a stop command.
14	Decrease Frequency	
15	Emergency stop (NO)	Generates an external fault (EF1). The function is identical to the external terminal (EF).
16	Emergency stop (NC)	

Setting	Functions	Descriptions
17	AVI(open), ACI1(close)	External selection of the Master Frequency command. (Analog input AVI = terminal open) or (ACI1 = terminal closed). This setting over-rides Pr.02-00.
18	KEYPAD(open), EXT(close)	External selection of the Operation Command Source. (Keypad = terminal open) or (External terminals = terminal closed). This setting is valid when Pr.02-01 is set to 00. Otherwise, the Operation Command Source will follow the setting in Pr.02-01.
19	PID disable	Disable PID feedback control and operate via Master Frequency Command source Pr.02-00.
20	Auxiliary 1 input	Parameter value 20 to 26 program Multi-Function Input Terminals (Pr.04-00~Pr.04-07) to correspond with the AC drive multi-function output terminals Pr.03-00 to 03-07 (settings 09-15).
21	Auxiliary 2 input	
22	Auxiliary 3 input	
23	Auxiliary 4 input	
24	Auxiliary 5 input	
25	Auxiliary 6 input	
26	Auxiliary 7 input	
27	Motor No.1 output disable	When multiple motors are controlled by an AC drive, these settings will allow the corresponding motor to disable and ignore this motor. AC drive will not accept a "Motor Output Disabled" signal when it is running.
28	Motor No.2 output disable	
29	Motor No.3 output disable	
29	Motor No.4 output disable	
31	All motor outputs disable	When multiplex motors are in circulative control mode, this terminal can stop the motor that power supply is not from AC drive and set the circulative control mode disable. Now only the motor in running keeps running.
32	Run PLC Program	Parameter value 32 programs Multi-Function Input Terminal to enable the AC drive internal PLC program. Parameter value 33 programs an input terminal to pause the PLC program. Note: Pr.05-00 to Pr.05-16 defines the PLC program.
33	Pause PLC Program	

04 - 08 Digital Input Terminal Response Time

Factory Setting: 01

Settings 01~20

 This parameter selects the response time of digital input terminals MI1 to MI8, EF, REV and FWD.

 AC drive will scan the digital input terminals once every 2msec. During each scan the drive will check the status of each terminal (open or closed).

 In noisy environments, it would be advantageous to verify the terminal status several times before executing a new command, nearly eliminating false signals.

 Example: If Pr.04-08 is set to 4, the AC drive will confirm the terminal status ($4+1 = 5$) 5 times before a change is made. This correlates to an 8~10msec time response from input command to execution.

 It is not recommended to set this parameter to 00, since interference may cause improper operation of the AC drive.

04 - 09	AVI Minimum Voltage	Factory Setting: 0.0
04 - 10	AVI Maximum Voltage	Factory Setting: 10.0
	Settings	0.0 ~ 10.0V Unit: 0.1

04 - 11	AVI Minimum Frequency (percentage of Pr.1-00)	Factory Setting: 0.00
04 - 12	AVI Maximum Frequency (percentage of Pr.1-00)	Factory Setting: 100.00
	Settings	0.00~100.00% Unit: 0.01

04 - 13	ACI1 Minimum Current	Factory Setting: 4.0
04 - 14	ACI1 Maximum Current	Factory Setting: 20.0
	Settings	0.0 ~ 20.0mA Unit: 0.1

04 - 15	ACI1 Minimum Frequency (percentage of Pr.1-00)	Factory Setting: 0.00
04 - 16	ACI1 Maximum Frequency (percentage of Pr.1-00)	Factory Setting: 100.00
	Settings	0.0~100.0% Unit: 0.01

04 - 17	ACI2 Minimum Current	Factory Setting: 4.0
04 - 18	ACI2 Maximum Current	Factory Setting: 20.0
	Settings	0.0 ~ 20.0mA Unit: 0.1

04 - 19	ACI2 Minimum frequency (percentage of Pr.1-00)	Factory Setting: 0.00
04 - 20	ACI2 Maximum frequency (percentage of Pr.1-00)	Factory Setting: 100.00
	Settings	0.00~100.00% Unit: 0.01

 The above parameters are used to set the analog input reference values. The min and max frequencies are based on Pr.01-00 (during open-loop control) or the PID reference value Pr.10-01 (during PID close-loop control).

Please refer to the following diagram for more details:

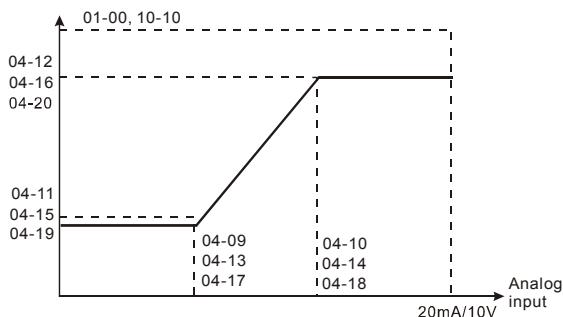

Example: Using the AVI(0~10V) as the target source and ACI1(4~20mA) corresponds to 0~5Pa) and ACI2(0~10mA) corresponds to 0~4Pa) as the feedback location for a pressure sensor connected. If your target value is between 3~7Pa (Set Pr.10-01 to 10, other parameters settings refer Pr.10-01 to set as shown in the following diagram and then setting the PID feedback relative parameters.) If setting AVI to 7.5V, pressure sum of ACI1 and ACI2 could be controlled at 6Pa.

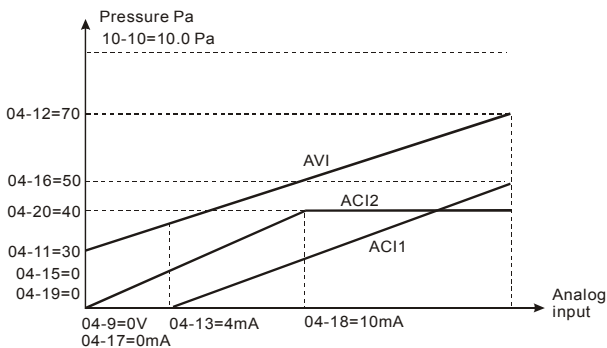



When analog input current of ACI1/ACI2 is lower than Pr.04-13/Pr.04-17, EF warning will pup-up.

04 - 21	Analog Input Delay AVI	Factory Setting: 0.50
04 - 22	Analog Input Delay ACI1	Factory Setting: 0.50
04 - 23	Analog Input Delay ACI2	Factory Setting: 0.50

Settings 0.00 ~ 10.00 Sec

Unit: 0.01

 This parameter selects the time constant for the analog input signal filter. A properly adjusted time constant may help filter noise on the analog input terminals.

 If the input delay is set too long, the system may experience oscillation. Be careful setting these parameters.

04 - 24	Summation of External Frequency Sources	Factory Setting: 00
----------------	---	---------------------

Settings

- 00: No functions
- 01: AVI+ACI1
- 02: ACI1+ACI2
- 03: ACI2+AVI
- 04: Communication master frequency +AVI
- 05: Communication master frequency +ACI1
- 06: Communication master frequency +ACI2

 This parameter selects the terminals used for summation of the External Frequency Sources.

5.6 Group 5: Multi-step Speed Frequency Parameters

05 - 00	1 st Step Speed Frequency	↗	Factory Setting: 0.00
05 - 01	2nd Step Speed Frequency	↗	Factory Setting: 0.00
05 - 02	3rd Step Speed Frequency	↗	Factory Setting: 0.00
05 - 03	4th Step Speed Frequency	↗	Factory Setting: 0.00
05 - 04	5th Step Speed Frequency	↗	Factory Setting: 0.00
05 - 05	6th Step Speed Frequency	↗	Factory Setting: 0.00
05 - 06	7th Step Speed Frequency	↗	Factory Setting: 0.00
05 - 07	8th Step Speed Frequency	↗	Factory Setting: 0.00
05 - 08	9th Step Speed Frequency	↗	Factory Setting: 0.00
05 - 09	10th Step Speed Frequency	↗	Factory Setting: 0.00
05 - 10	11th Step Speed Frequency	↗	Factory Setting: 0.00
05 - 11	12th Step Speed Frequency	↗	Factory Setting: 0.00
05 - 12	13th Step Speed Frequency	↗	Factory Setting: 0.00
05 - 13	14th Step Speed Frequency	↗	Factory Setting: 0.00
05 - 14	15th Step Speed Frequency	↗	Factory Setting: 0.00

Settings 0.00~120.00 Hz

Unit: 0.01

 The Multi-Function Input Terminals (refer to Pr.04-00 to 04-07) are used to select one of the AC drive Multi-Step speeds. The speeds (frequencies) are determined by Pr.05-00 to 05-14 shown above.

05 - 15	PLC Mode	Factory Setting: 00
----------------	----------	---------------------

- | | | |
|----------|----|--|
| Settings | 00 | Disable PLC operation |
| | 01 | Execute one program cycle |
| | 02 | Continuously execute program cycles |
| | 03 | Execute one program cycle step by step |
| | 04 | Continuously execute program cycles step by step |

 This parameter selects the mode of PLC operation for the AC drive. The AC drive will change speeds and directions according to the user's desired programming.

Example 1 (Pr.05-15 = 1): Execute one cycle of the PLC program. Its relative parameter settings are:

- Pr.05-00 to 05-14: 1st to 15th step speed (sets the frequency of each step speed)
- Pr.04-00 to 04-07: Multi-Function Input Terminals (set one multi-function terminal as 32 - PLC auto-operation).
- Pr.03-00 to 03-07: Multi-Function Output Terminals (set a Multi-Function Terminal as 34-PLC running indication, 35-PLC step completed or 36-PLC program completed).
- Pr.05-16: Direction of operation for the 1st to 15th step speed.
- Pr.05-17 to 05-31: Operation time setting of the 1st to 15th step speed.

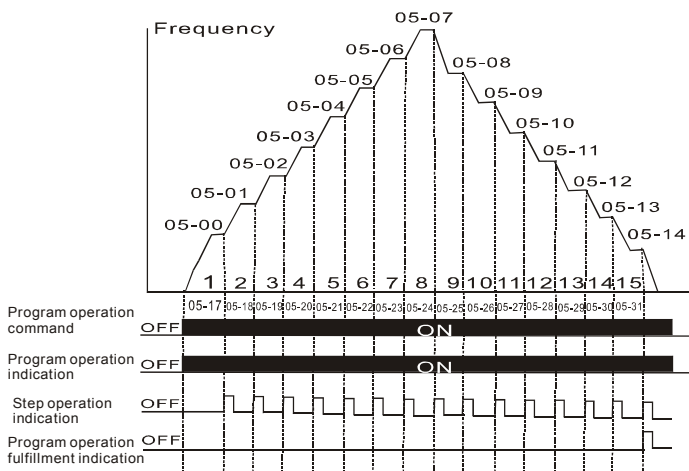

Note: The above diagram shows one complete PLC cycle. To restart the cycle, turn the PLC program off and on again.

Example 2 (Pr.05-15 = 2): Continuously executes program cycles:

The diagram above shows the PLC program stepping through each speed. Set Pr.05-15 to 2 continuously executes the program. To stop the PLC program, one must either pause the program or turn it off. (Refer to Pr.04-00 to 04-07 values 32 and 33).

Example 3 (Pr.05-15 = 3) Execute one cycle step by step:

The example below shows how the PLC can perform one cycle at a time, within a complete cycle. Each step will use the accel/decel times in Pr.01-09 to Pr.01-16. It should be noticed that the time each step spends at its intended frequency is diminished, due to the time spent during accel/decel.

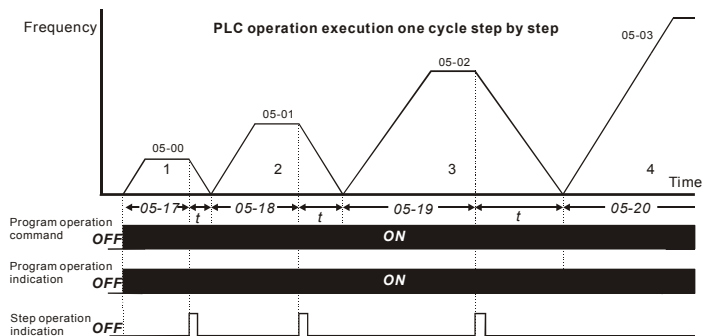

05 - 16 PLC Forward/Reverse Motion

Factory Setting: 00

Settings 00 to 32767

This parameter controls the direction of motion for the Multi-Step Speeds Pr.05-00 to Pr.05-14 during PLC mode. All other direction commands are invalid during the PLC mode.

Note:

The equivalent 15-bit number is used to program the forward/reverse motion for each of the 15 speed steps. The binary notation for the 15-bit number must be translated into decimal notation and then entered.

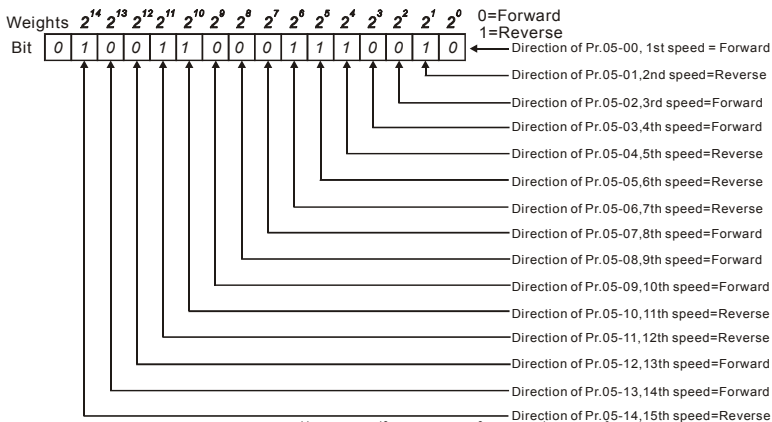
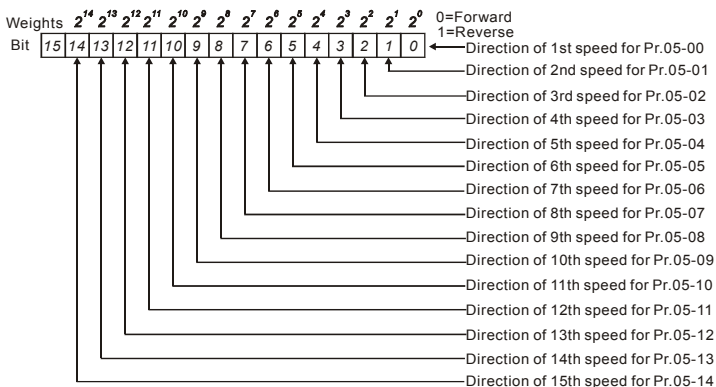

$$\begin{aligned}
 \text{The setting value} &= \text{bit}14 \times 2^{14} + \text{bit}13 \times 2^{13} + \dots + \text{bit}2 \times 2^2 + \text{bit}1 \times 2^1 + \text{bit}0 \times 2^0 \\
 &= 1 \times 2^{14} + 1 \times 2^{11} + 1 \times 2^{10} + 1 \times 2^6 + 1 \times 2^5 + 1 \times 2^4 + 1 \times 2^1 \\
 &= 16384 + 2048 + 1024 + 64 + 32 + 16 + 2 \\
 &= 19570
 \end{aligned}$$

Setting 05-16 = 19570

NOTE:

2^{14} = 16384	2^{13} = 8192	2^{12} = 4096	2^{11} = 2048	2^{10} = 1024
2^9 = 512	2^8 = 256	2^7 = 128	2^6 = 64	2^5 = 32
2^4 = 16	2^3 = 8	2^2 = 4	2^1 = 2	2^0 = 1

05 - 17	Time Duration of 1st Step Speed	Factory Setting: 0.0
05 - 18	Time Duration of 2nd Step Speed	Factory Setting: 0.0
05 - 19	Time Duration of 3rd Step Speed	Factory Setting: 0.0
05 - 10	Time Duration of 4th Step Speed	Factory Setting: 0.0
05 - 21	Time Duration of 5th Step Speed	Factory Setting: 0.0
05 - 22	Time Duration of 6th Step Speed	Factory Setting: 0.0
05 - 23	Time Duration of 7th Step Speed	Factory Setting: 0.0
05 - 24	Time Duration of 8th Step Speed	Factory Setting: 0.0
05 - 25	Time Duration of 9th Step Speed	Factory Setting: 0.0
05 - 26	Time Duration of 10th Step Speed	Factory Setting: 0.0
05 - 27	Time Duration of 11th Step Speed	Factory Setting: 0.0
05 - 28	Time Duration of 12th Step Speed	Factory Setting: 0.0
05 - 29	Time Duration of 13th Step Speed	Factory Setting: 0.0
05 - 30	Time Duration of 14th Step Speed	Factory Setting: 0.0
05 - 31	Time Duration of 15th Step Speed	Factory Setting: 0.0

Settings 0.0 to 65500

Unit: 1 /0.1sec

 Pr.05-17 to Pr.05-31 correspond to operation time of each step speed defined by Pr.05-00 to Pr.05-14. The maximum setting 65500 seconds will be displayed as t6550. If it is displayed t6550. that means 6550 seconds.

Note: If a parameter is set to "00" (0 sec), the corresponding step will be skipped. This is commonly used to reduce the number of program steps.

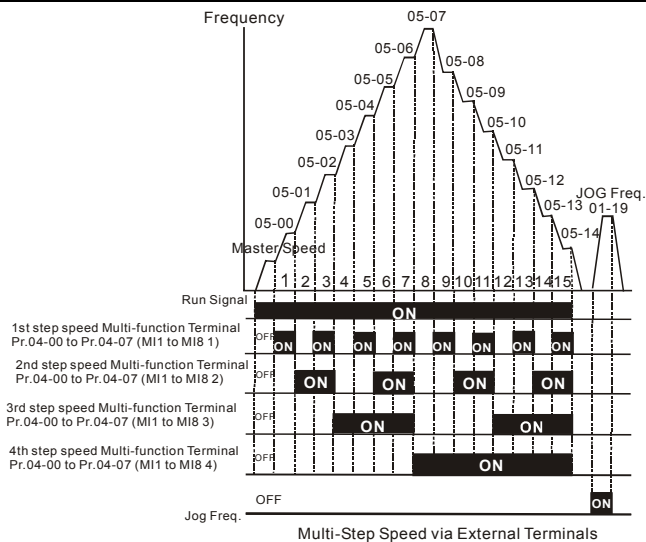



05 - 32 Time Unit Settings Factory Setting: 00

Settings 00 1 Sec
 01 0.1 Sec

This parameter determines the time unit for Pr.05-17~Pr.05-31.



5.7 Group 6: Protection Function Parameters

06 - 00	Over-voltage Stall Prevention	Factory Setting: 390.0/780.0
Settings	230V series: 330.0 ~ 410.0VDC 460V series: 660.0 ~ 820.0VDC 00: Disable	

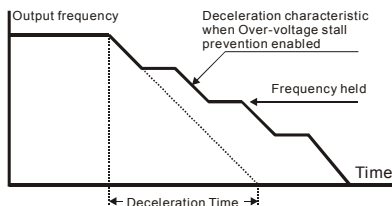
-  This parameter selects the voltage level for the Over-Voltage Stall Prevention function.
-  During decelerations, the DC bus voltage may exceed its maximum allowable value due to motor regeneration. When this function is enabled, the AC drive will stop decelerating and maintain a constant output frequency. The AC drive will only resume deceleration when the voltage drops below the preset value.
-  With moderate inertial loads, the over-voltage stall prevention will not occur and the deceleration time should be equal to Pr.1-10. With high inertial loads, the AC drive will automatically extend the deceleration time due to the step function shown below. If the deceleration time is critical for the application, then dynamic brake resistors should be used.



06 - 01	Over-current Stall Prevention during Acceleration	Factory Setting: 120
Settings	20~150%	Unit: 1

-  This parameter selects the percentage of allowable over-current during acceleration before the stall prevention is enabled.
-  During acceleration, the AC drive output current may increase abruptly and exceed the value specified by Pr.06-01 due to rapid acceleration or excessive load on the motor. When this function is enabled, the AC drive will stop accelerating and maintain a constant output frequency. The AC drive will only resume acceleration when the current drops below the value set in Pr.06-01 (please see the graph below).
-  When the over-current stall prevention is activated, the acceleration time of the AC drive will be longer than the time set in Pr. 01-09.

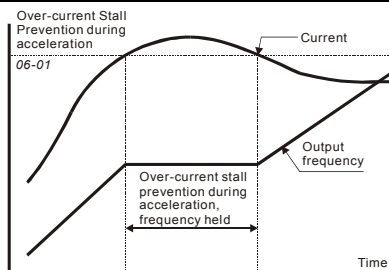

Over-current Stall Prevention during Acceleration

06 - 02 Over-current Stall Prevention during operation Factory Setting: 120

Settings 20~150%

Unit: 1

This parameter selects the percentage of allowable over-current during operation before the stall prevention function is enabled.

If the output current exceeds the value specified in Pr.06-02 when the drive is operating at steady state speed, the drive will decrease its output frequency to prevent the drive from faulting with an OC. Once the current falls below the value specified in Pr.06-02, the drive will then accelerate to catch up with the command frequency.

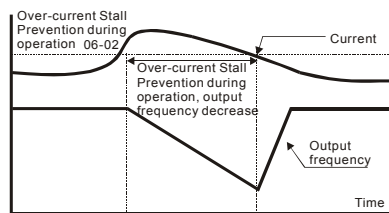

Over-current Stall Prevention during Operation

06 - 03 Over-torque Detection Selection Factory Setting: 00

- Settings
- 00: Over-torque detection disabled.
 - 01: Over-torque detection enabled during constant speed operation (OL2), and operation continues.
 - 02: Over-torque detection enabled during constant speed operation (OL2), and operation halted.
 - 03: Over-torque detection enabled during operation (OL2), and operation continues.
 - 04: Over-torque detection enabled during constant speed operation (OL2), and operation halted.

 This parameter selects the Over-torque Detection operation.

 If this parameter is set to 01 or 02, over-torque detection will not occur during acceleration.

06 - 04	Over-torque Detection Level	Factory Setting: 110
Settings	30~150%	Unit: 1

 This parameter sets the Over-torque Detection level based on the AC drive rated current.

06 - 05	Over-torque Detection Time	Factory Setting: 0.1
Settings	0.1~60.0 Sec	Unit: 0.1

 This parameter selects the allowable time of Over-torque Detection before the AC drive faults with an OL2.

 When the output current exceeds Pr.06-04 for the time set in Pr06-05, AC drive will fault and display "OL2" on the keypad.

06 - 06	Electronic Thermal Relay Selection	Factory Setting: 02
Settings	00: Operation disabled. 01: Operation with a standard motor (shaft mounted fan cooled). 02: Operation with a vector motor (non-fan cooled or self powered fan)	

 This parameter provides electronic thermal protection for the motor. When the output current exceeds Pr.07-02 for the time set in Pr.06-07, the drive will fault with an OL1.

06 - 07	Electronic Thermal Characteristic	Factory Setting: 60
Settings	30~600 Sec	Unit: 1

 This parameter selects the time required for the electronic thermal protection function to activate.

 When Pr.6-06 is set for 1 or 2 and the output current exceeds Pr.7-02 for the time set in Pr.6-07, the drive will fault with an OL1.

 The common electronic thermal reaction time (150% output current for 1 minute) is shown in the chart below. The actual reaction time will vary depending on output current.

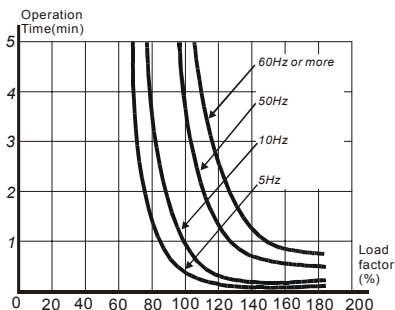

06 - 08	Low Current Detection Level	Factory Setting: 00
	Settings 00~100% (00 disabled)	Unit: 1
06 - 09	Low Current Detection Time	Factory Setting: 10.0
	Settings 0.1~ 3600.0 Sec	Unit: 0.1
06 - 10	Low Current Detection Treatment	Factory Setting: 01
	Settings 00: Warn and Ramp to stop 01: Warn and Coast to stop 02: Warn and keep operating	

These parameters set the low current detection mode, time, and operation.

06 - 11	Present Fault Record	Factory Setting: 00
06 - 12	Second Most Recent Fault Record	Factory Setting: 00
06 - 13	Third Most Recent Fault Record	Factory Setting: 00
06 - 14	Fourth Recent Fault Record	Factory Setting: 00
	Settings 00 No fault occurred	
	01 Over-current (oc)	
	02 Over-voltage (ov)	
	03 Overheat (oH)	
	04 Overload (oL)	
	05 Electronic thermal relay (oL1)	
	06 External fault (EF)	
	07 AC drive IGBT fault (occ)	
	08 CPU failure (cF3)	
	09 Hardware protection failure (HPF)	

-
- 10 Over current during acceleration (ocA)
 - 11 Over current during deceleration (ocd)
 - 12 Over current during steady state operation (ocn)
 - 13 Ground fault (GFF)
 - 14 Under voltage (Lv)
 - 15 EEPROM WRITE failure (cF1)
 - 16 EEPROM READ failure (cF2)
 - 17 Base Block (bb)
 - 18 Motor over load (oL2)
 - 19 Reserved
 - 20 Software/password protection (codE)
 - 21 External emergency stop (EF1)
 - 22 Phase-Loss (PHL)
 - 23 Low-current (Lc)
 - 24 FbL (Feedback Loss)
 - 25 Reserved
 - 26 Fan Power Fault (FAnP)
 - 27 Fan 1 Fault (FF1)
 - 28 Fan 2 Fault (FF2)
 - 29 Fan 3 Fault (FF3)
 - 30 Fan 1, 2, 3 Fault (FF123)
 - 31 Fan 1, 2 Fault (FF12)
 - 32 Fan 1, 3 Fault (FF13)
 - 33 Fan 2, 3 Fault (FF23)
 - 34 Gate Drive Low Voltage Protect (Fv)

06 - 15 Parameter Reset

Factory Setting: 00

- Settings 00~65535
- 09: Reset parameters (50Hz, 220/380)
 - 10: Reset parameters (60Hz, 220/440)

 This parameter resets all parameters to the factory setting.

06 - 16 Parameter Protection Password Input

Factory Setting: 00

- Settings 00~65535

 This parameter allows the user to enter their password to unlock the Parameter Protection feature. The password entered must match the value entered into Pr.6-17. After three invalid password attempts, the drive will no longer allow any operation. The drive must then be powered off and back on again.

 After successfully entering the password, the user may change parameters as they wish. Once the drive is powered off, the drive has locked the parameters again. To clear the password, the user must enter the correct password in Pr.6-16 and then set Pr.6-17 to 00.

06 - 17 Parameter Protection Password Setting

Factory Setting: 00

Settings 00~65535
 00: No password protection

 This parameter allows the user to set a password for parameter protection. After entering a password, Pr.6-17 will display 1.

 Be sure to keep the password in a safe place. If the password is lost, please return the drive to DELTA.

5.8 Group 7: AC Drive and Motor Parameters

07 - 00 Identity Code of AC Drive Factory Setting: ##

Settings Display by model type

 This parameter displays the AC drive model code.

 This parameter is read-only.

07 - 01 Rated Current of AC Drive Factory Setting: ##

Settings Display by model type

 This parameter displays rated output current of the AC drive. The following chart may be used to look up the identity code, current, and hp of your drive.

230V series

KW	0.75	1.5	2.2	3.7	5.5	7.5	11	15	18.5	22	30	37
HP	1	2	3	5	7.5	10	15	20	25	30	40	50
Pr.07-00	4	6	8	10	12	14	16	18	20	22	24	26
Rated current (A)	5	7	11	17	25	33	49	65	75	90	120	145
Max. Carried Freq.	10KHz						9KHz			6KHz		
Min. Carried Freq.	4KHz						3KHz			2KHz		
Factory Setting	9KHz						6KHz			4KHz		

460V series

KW	0.75	1.5	2.2	3.7	5.5	7.5	11	15	18.5	22	30	37	45	55	75	90	110	130	160	185	220
HP	1.0	2.0	3.0	5.0	7.5	10	15	20	25	30	40	50	60	75	100	125	150	175	215	250	300
Pr.07-00	05	07	09	11	13	15	17	19	21	23	25	27	29	31	33	35	37	39	41	43	45
Rated Current (A)	2.7	4.2	5.5	8.5	13	18	24	32	38	45	60	73	91	110	150	180	220	260	310	370	460
Max. Carried Freq.	10KHz						9KHz			6KHz											
Min. Carried Freq.	4KHz						3KHz			2KHz											
Factory Setting	9KHz						6KHz			4KHz											

 This parameter is read-only.

07 - 02 Full-load Current of Motor Factory Setting: 100%

Settings 30~120%

Unit: 1

 This parameter selects the full load current of the motor.

 Pr7-02 = (full load motor current / drive rated current)

 Example: If the rated current of AC drive is 150A, full-load current of motor is 120A, then Pr.7-02 should be set to 80%.

 This parameter is used with slip compensation Pr.7-04 to Pr.7-05 and electronic thermal relay Pr.6-06 to Pr.6-07. An incorrect setting will cause these functions to not work incorrectly and may damage the motor and drive.

 The full-load current of the motor must be equal to or less than (but not less than 50%) the rated current of the AC drive.

07 - 03	No-load Current of Motor		Factory Setting: 30%
	Settings 1~99%		Unit: 1

 This parameter sets the no-load current of the motor.
Pr.7-03 = (no load current / drive rated current)

Example: If the rated current of the AC drive is 150A and no-load current of the motor is 40A, then Pr.7-03 should be set to 27%.

 This parameter is used with slip compensation Pr.7-04 and Pr.7-05. An incorrect setting will cause the function to work incorrectly and may damage the motor and drive.

 If the no-load current of the motor is unavailable, it may be found by running the motor with no load and reading the current on the keypad display.

07 - 04	Auto Slip Compensation Gain		Factory Setting: 0.0
	Settings 0.0~3.0		Unit: 0.1

 This parameter is set to auto slip compensation gain.

 Rotor speed of the motor (output frequency of AC drive) can't synchronize due to induction motor characteristic. The difference between synchronization speed and rotor speed is called slip frequency. Slip frequency is in direct proportion with output torque and output current. Therefore, slip compensation could make rotor speed and master frequency command the same according output current (Io).

 The equation of slip compensation is $(07-05) \times (07-04) \times (I_o - (07-03)) / ((07-02) - (07-03))$. If rated current of AC drive is 150A, full-load current of the motor is 120A, no-load current is 40A, rated slip frequency is 5Hz and output current of AC drive is 100A. At this time, slip compensation is $(07-04) \times 5 \times (100-40) / (120-40) = 3.75 \times (07-04)$. If 07-04 is set to 1.0 and the compensation is 3.75. If master frequency command is set to 50Hz and output frequency is 53.75.

 Output frequency after compensation is limited by 01-07 upper bound frequency. When using slip compensation, 01-07 should be set to the suitable value.

 When PID feedback control, slip compensation function will be disabled.

Unsuitable setting value may cause over compensation.

07 - 05	Rated Slip Frequency of Motor	Factory Setting: 0.00
	Settings 0.00~20.00Hz	Unit: 0.01

This parameter is to set rated slip of loaded motor. Users need to input rated rotation speed according to nameplate of loaded motor. If rated frequency of motor is 60Hz, number of motor poles is 4 and rated rotation speed of motor is 1650rpm. The rated slip frequency of motor is $60\text{Hz} - (1650\text{rpm} \times 4/120) = 5\text{Hz}$.

This parameter has relation with 07-04 slip compensation. To have the best slip compensation, this parameter must be set correctly. Incorrect setting may cause above functions disable and even damage the motor and AC drive.

07 - 06	Auto Torque Compensation Gain	Factory Setting: 0.0
	Settings 0.0~10.0	Unit: 0.1

This parameter is to set auto torque compensation gain.

When motor loading is high, a part of output frequency of AC drive will be absorbed by impedance of stator winding to make voltage of exciting inductance of motor is not enough. Therefore, the short of gap magnet field will make a high output current but low output torque. Auto torque compensation gain could adjust output voltage automatically according to loading to maintain in a fixed gap magnet of the motor to get the best running situation.

If the setting of compensation gain is too great, over-exciting magnet will cause the following situation: output current of AC drive is too great, motor is over-heating or protection function occurs.

07 - 07	Torque Compensation Gain by Manual Operation	Factory Setting: 0.0
	Settings 0.0~10.0	Unit: 1.0

This parameter determines torque compensation gain by manual operation.

Torque compensation gain by manual operation won't refer to the loading situation and adds compensation voltage on the setting V/f curve. Basically, it just changes V/f curve. It could be reached by adjusting V/f curve.

07 - 08	Calculate Total Running Time of the Motor (Min)	Factory Setting: 00
	Settings 00 to 1439 Min	Unit: 1

07 - 09	Calculate Total Running Time of the Motor (Day)	Factory Setting: 00
	Settings 00 to 65535 Day	Unit: 1

This parameter could display running time of the motor.

5.9 Group 8: Special Parameters

08 - 00	DC Brake Current Level	Factory Setting: 00
	Settings 00~100%	Unit: 1

 This parameter determines the level of DC brake current output.

08 - 01	DC Brake Time during Start-up	Factory Setting: 0.0
	Settings 0.0~60.0 Sec	Unit: 0.1

 This parameter determines the duration of time that the DC brake current will be applied to the motor during the AC drive start-up.

 The motor may rotate by external force or inertia itself before operating. It may damage the motor or start the AC drive protection function by an over current if the AC drive added at this time. This parameter enable the AC drive to output a direct current before running the motor that will produce a torque to forced motor stop and get a steady start-up characteristic.

08 - 02	DC Brake Time during Stopping	Factory Setting: 0.0
	Settings 0.00~60.00 Sec	Unit: 0.01

 This parameter determines the duration of time that the DC brake current will be applied to the motor during stopping.

 Motor may be in rotation status after AC drive stops output and can't in stop status accuracy when motor is running with external force or itself inertia. After AC drive stops output, this parameter could output a DC current to produce torque force motor to stop and make sure the motor has stopped accuracy.

08 - 03	Start-point for DC Brake	Factory Setting: 0.00
	Settings 0.00~120.00 Hz	Unit: 0.01

 This parameter determines the frequency when DC brake will begin during deceleration.

 If this parameter is set greater than 01-05 minimum frequency setting, it won't decelerate to 01-05 and enter DC brake status when AC drive brakes. Suitable DC brake start-up frequency setting will get better brake characteristic.

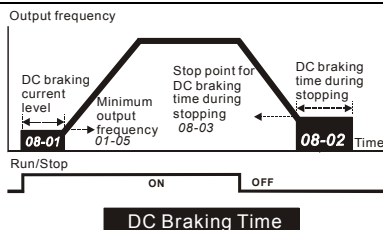

DC Braking Time

08 - 04 Momentary Power Loss Operation Selection Factory Setting: 00

- Settings 00: Disable
 01: Trace from top downward
 02: Trace from bottom upward

- This parameter determines the start-up mode after momentary power loss operation.
- The power system connects to AC drive may occurred momentary power loss by any probably reason. This function can make AC drive output voltage continuously after power loss and AC drive won't stop by power loss.
- If this parameter is set to 01, AC drive will trace from the last frequency before power loss downward. After output frequency of AC drive and running speed of the motor is synchronization, it will accelerate to master frequency command. It is recommended to use this setting if the motor loading has the characteristics of high inertial and low resistance.
- If this parameter is set to 02, AC drive will trace from the Min. frequency upward. After output frequency of AC drive and running speed of the motor is synchronization, it will accelerate to master frequency command. It is recommended to use this setting if the motor loading has the characteristics of low inertial and high resistance.

08 - 05 Maximum Allowable Power Loss Time Factory Setting: 2.0

- Settings 0.1~5.0 Sec Unit: 0.1

- This parameter determines the maximum allowable power loss time. If the power loss time is less than the time defined by this parameter, the AC drive will execute 08-04 momentary power loss operation.
- The allowable power loss time is beginning to count time after AC drive displays Lu. Therefore, actual allowable power loss time will change with loading.
- The allowable power loss time must in the condition that AC drive auxiliary power is working normally. If auxiliary power is turned off in the allowable power loss time, the actual allowable power loss time will be shorter than the parameter setting.

08 - 06 Speed Search Time

Factory Setting: 0.5

Settings 0.1~5.0 Sec

Unit: 0.1

This parameter determines the delay time from fault (power loss, OV, OC or BB) recovery to start to execute the function of speed search time.

08 - 07 Maximum Speed Search Current

Factory Setting: 110

Settings 30~150%

Unit: 1

This parameter determines maximum current of speed search.

Maximum speed search current will have influence with synchronization attained time. The greater this parameter is set, the faster it will be synchronization. But if the parameter setting value is too great, it may occur over-loaded protection.

If 08-04 is set to 01: when speed search is from top downward, output frequency is searched from master frequency command downward. Now output voltage and output current will be added from zero. When output current is equal to 08-07 setting value, AC drive output current will retain in a fixed value and output frequency will keep on searching from top downward. When output frequency and output voltage is overlapped with V/f setting frequency, AC drive will judge that is synchronization attained and accelerates from V/f curve to master frequency command.

If 08-04 is set to 02: AC drive will accelerate according to V/f curve and won't do any special treatment.

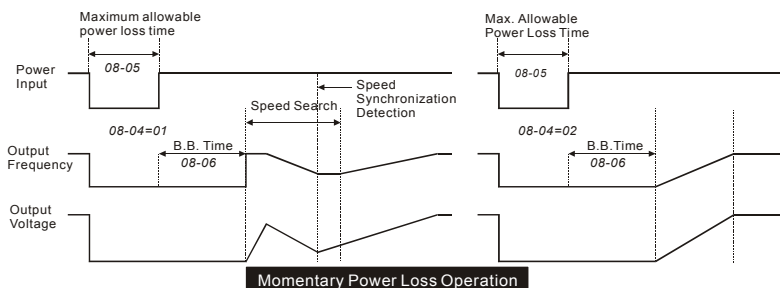

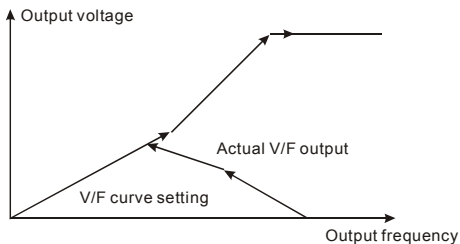
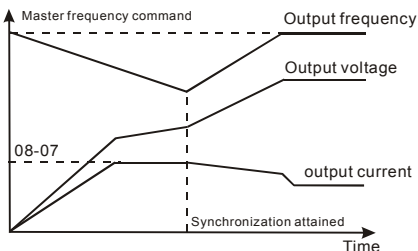

08 - 08 BB Speed Search Method

Factory Setting: 00

- Settings 00: Trace from top downward
01: Trace from bottom upward

- 📖 This parameter determines BB speed search method when multi-function input terminal 04-00 to 04-07 is set to BB External interrupt (11 or 12) and activates.
- 📖 BB speed search method is the same with restart speed search after momentary loss power.

08 - 09 Auto Restart Times After Fault

Factory Setting: 00

- Settings 00 ~10

- 📖 This parameter determines the times of auto restart after fault.
- 📖 When AC drive occurs fault (OV, OC or OCC) and fault disappeared automatically, this parameter allows AC drive reset and runs with the parameter that is set before fault occurred.
- 📖 If fault occurred times exceed 08-09 setting, AC drive will reject to restart and need to reset by users to keep on running.

08 - 10	Auto Restart Time after Fault	Factory Setting: 600
	Settings 00 to 60000 sec	Unit:

This parameter determines auto restart time after fault. After fault occurs and restart, there is no fault occurs during 08-10 setting time, AC drive will reset fault occurred record to zero.

08 - 11	Operation Frequency Inhibition 1 UP	Factory Setting: 0.00
08 - 12	Operation Frequency Inhibition 1 DOWN	Factory Setting: 0.00
08 - 13	Operation Frequency Inhibition 2 UP	Factory Setting: 0.00
08 - 14	Operation Frequency Inhibition 2 DOWN	Factory Setting: 0.00
08 - 15	Operation Frequency Inhibition 3 UP	Factory Setting: 0.00
08 - 16	Operation Frequency Inhibition 3 DOWN	Factory Setting: 0.00
	Settings 0.00~120.00 Hz	Unit: 0.01

This parameter determines the inhibition operation frequency range. This function will let AC drive not run continuous in the resonance frequency of the motor or loading system, or inhibition operation frequency.

The settings of this parameter should follow as $08-11 \geq 08-12 \geq 08-13 \geq 08-14 \geq 08-15 \geq 08-16$.

Master frequency command can be set in inhibition operation frequency range. Now the output frequency will be limited in the lower bound of inhibition operation frequency.

When AC drive accelerates or decelerates, output frequency will pass through inhibition operation frequency range.



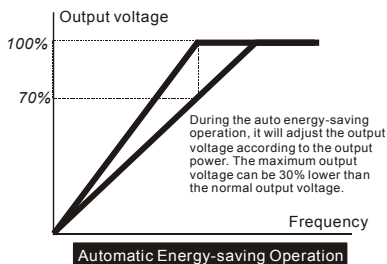

08 - 17	Automatic Energy-saving	Factory Setting: 00
	Settings 00: Energy-saving operation disabled 01: Energy-saving operation enabled	

This parameter determines automatic energy-saving function.





08 - 18	Automatic Voltage Regulation (AVR)	Factory Setting: 00
----------------	---	---------------------

Settings	00: AVR function enabled 01: AVR function disabled 02: AVR function disabled for deceleration
----------	---

-  This parameter determines the function of Automatic Voltage Regulation is enabled or disabled.
-  This parameter is set to 01: when AVR function is disabled, AC drive will calculate input voltage by DC Bus value (620VDC). Output voltage will vary by DC Bus varying and may cause output current insufficiently, over current or oscillation.
-  This parameter is set to 00: when AVR function is enabled, AC drive will calculate output voltage by actual voltage value of DC Bus. Output voltage won't vary by DC Bus varying.
-  This parameter is set to 02: AC drive will disable AVR function during decelerate to stop. It can speed up braking in some degree.

08 - 19	Software Setting of the Brake Level (the action level of the brake resistor)	↗	Factory Setting: 380.0/ 760.0
----------------	--	---	----------------------------------

Settings	230V series: 370.0 ~ 410.0VDC 460V series: 740.0 ~ 820.0VDC 00: Disable	Unit: 0.1
----------	---	-----------

-  This parameter determines software setting of the brake level.
-  The model VFD007~150F43A has brake chip, user could select suitable brake resistor to have the best deceleration characteristics.
-  The action level of the brake resistor could be set by this parameter.

08 - 20	Vibration Compensation Factor	↗	Factory Setting: 00
----------------	--------------------------------------	---	---------------------

Settings	00~1000	Unit: 1
----------	---------	---------

-  This parameter will minimize vibration at low speed during vector control. The value of the parameter is a GAIN. The higher the value, the more vibration dampening that will occur.

5.10 Group 9: Communication Parameters

09 - 00	Communication Address	↗	Factory Setting: 01
	Settings	01: 254 00: Disable	

 If the AC drive is controlled by RS-485 serial communication, the communication address for this drive must be set via this parameter.

09 - 01	Transmission Speed (Baud Rate)	↗	Factory Setting: 01
	Settings	00: Baud rate 4800 01: Baud rate 9600 02: Baud rate 19200 03: Baud rate 38400	

 This parameter determines transmission speed of AC drive communication.

09 - 02	Transmission Fault Treatment	↗	Factory Setting: 03
	Settings	00: Warn and keep operating 01: Warn and RAMP to stop 02: Warn and COAST to stop 03: No warning and no display	

 This parameter is set to detect if an error occurs and take actions.

09 - 03	Time-out Detection during Transmission		Factory Setting: 00
	Settings	00: Disable 01: Enable	

 This parameter is used for ASCII mode. When this parameter is set to 01, indicates that the over time detection is enable, the time slot between each character can't exceed 500 ms.

09 - 04	Communication Format		Factory Setting: 00
	Settings	00: 7-bit for ASCII 01: 8-bit for ASCII 02: 8-bit for RTU	

09 - 05	Even/Odd Parity and Stopping Parity Setting		Factory Setting: 00
	Settings	00: None parity + 2 stop bit 01: Even parity + 2 stop bit 02: Odd parity + 2 stop bit 03: None parity + 1 stop bit 04: Even parity + 1 stop bit 05: Odd parity + 1 stop bit	

 This parameter determines the communication format of serial communication.

09 - 06	Communication Operation Command 1	↗	Factory Setting: 00
Settings	Bit0~1: 00: Disable 01: Stop 10: Start-up 11: JOG start-up Bit2~3: Reserved Bit4~5: 00: No function 01: FWD command 10: REV command 11: Direction change command Bit6~7: 00: 1 st step acce/decel speed 01: 2 nd step acce/decel speed 10: 3 rd step acce/decel speed 11: 4 th step acce/decel speed Bit8~11: 0000: Master speed 0001: 1 st step speed 0010: 2 nd step speed 0011: 3 rd step speed 0100: 4 th step speed 0101: 5 th step speed 0110: 6 th step speed 0111: 7 th step speed 1000: 8 th step speed 1001: 9 th step speed 1010: 10 th step speed 1011: 11 th step speed 1100: 12 th step speed 1101: 13 th step speed 1110: 14 th step speed 1111: 15 th step speed Bit12: Select Bit6~11 function Bit13~15: Reserved		

 This parameter can be set by communication settings. It can't be set by keypad.

09 - 07	Communication Frequency Setting	↗	Factory Setting: 60.00
Settings	0~120.00Hz		Unit: 0.01

 This parameter can be set by communication settings. It can't be set by keypad.

09 - 08	Communication Operation Command 2	↗	Factory Setting: 00
Settings	Bit0: 1: EF ON Bit1: 1: Reset Bit2: 0: BB OFF, 1: BB ON Bit3~15: Reserved		

 This parameter can be set by communication settings. It can't be set by keypad.

If you set BB action by this parameter and you also need to disable BB action by this parameter.

There is a built-in RS-485 serial interface, marked (RJ-11 jack) on the control terminal block. The pins are defined below:

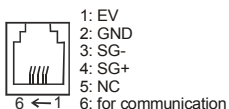

Each AC drive has a pre-assigned communication address specified by 9-00. The computer then controls each AC drive according to its communication address.

AC drive can be setup to communicate on Modbus networks using one of the following modes: ASCII (American Standard Code for Information interchange) or RTU (Remote Terminal Unit). Users can select the desired mode along with the serial port communication protocol in 09-04 and 09-05.

5

Code Description:

ASCII mode:

Each 8-bit data is the combination of two ASCII characters. For example, a 1-byte data: 64 Hex, shown as '64' in ASCII, consists of '6' (36Hex) and '4' (34Hex).

Character	'0'	'1'	'2'	'3'	'4'	'5'	'6'	'7'
ASCII Code	30H	31H	32H	33H	34H	35H	36H	37H

Character	'8'	'9'	'A'	'B'	'C'	'D'	'E'	'F'
ASCII Code	38H	39H	41H	42H	43H	44H	45H	46H

RTU mode:

Each 8-bit is the combination of two 4-bit hexadecimal characters. For example, 64 Hex.

2. Data format

2.1 10-bit character frame (for 7-bit) :

❖ (7 , N , 2 : 9-04=0, 9-05=0)

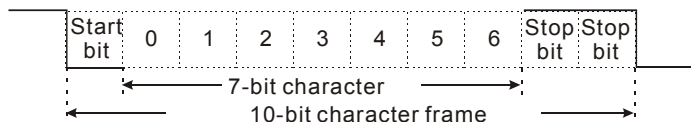

❖ (7, E, 1 : 9-04=0, 9-05=04)

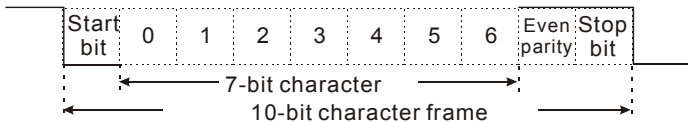

❖ (7, O, 1 : 9-04=0, 9-05=05)

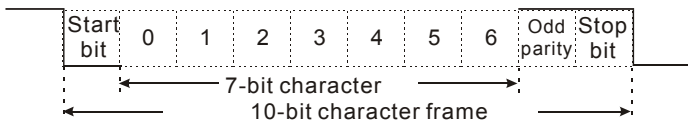

2.2 11-bit character frame (for 8-bit) :

❖ (8, N, 2 : 9-04=1 or 2, 9-05=00)

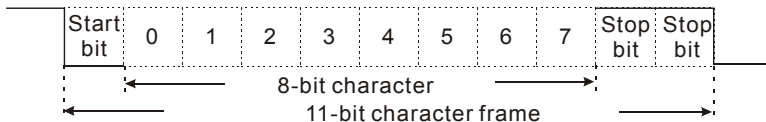

❖ (8, E, 1 : 9-04=1 or 2, 9-05=04)

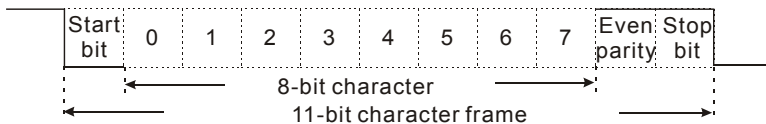

❖ (8, O, 1 : 9-04=1 or 2, 9-05=05)

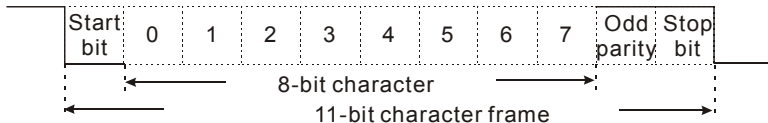

3. Communication Protocol

3.1 Communication Data Frame:

ASCII mode:

STX	Start character ':' (3AH)
ADR 1	Communication address:
ADR 0	8-bit address consists of 2 ASCII codes
CMD 1	Command code:
CMD 0	8-bit command consists of 2 ASCII codes
DATA (n-1)	Contents of data:
.....	N X 8-bit data consists of 2n ASCII codes.
DATA 0	n<=25, maximum of 50 ASCII codes
LRC CHK 1	LRC check sum:
LRC CHK 0	8-bit check sum consists of 2 ASCII codes
END 1	End characters:
END 0	END1= CR (0DH), END0= LF(0AH)

RTU mode:

START	A silent interval of more than 10 ms
ADR	Communication address: 8-bit address
CMD	Command code: 8-bit command
DATA (n-1)	Contents of data:
.....	N X 8-bit data, n<=25
DATA 0	
CRC CHK Low	CRC check sum:
CRC CHK High	16-bit check sum consists of 2 8-bit characters
END	A silent interval of more than 10 ms

3.2 ADR (communication address)

Valid communication addresses are in the range of 0 to 254. a communication address equal to 0, means broadcast to all AC drives (AMD). In this case, the AMD will not reply any message to the master device.

For example, communication to AMD with address 16 decimal:

ASCII mode: (ADR 1, ADR 0) = '1','0' => '1'=31H, '0'=30H

RTU mode: (ADR) = 10H

3.3 CMD (command code) and DATA (data character)

The format of data characters depends on the command code. The available command codes are described as followed:

- Command code: 03H, read N words. The maximum value of N is 10. For example, reading parameters 01-01 and 01-02 from address 01H.

ASCII mode:

Command message:		Response message:		Error response message	
STX	'.'	STX	'.'	STX	'.'
ADR 1	'0'	ADR 1	'0'	ADR 1	'0'
ADR 0	'1'	ADR 0	'1'	ADR 0	'1'
CMD 1	'0'	CMD 1	'0'	CMD 1	'8'
CMD 0	'3'	CMD 0	'3'	CMD 0	'3'
Starting data address	'0'	Number of data(Word)	'0'	Error code	'0'
	'1'		'4'		'2'
	'0'	Data of 0101H	'1'	LRC CHK 0	'6'
Number of data (Word)	'0'		'7'	LRC CHK 1	'D'
	'0'	Data of 0102H	'7'	END 1	CR
	'0'		'0'	END 0	LF
	'2'		'8'		
LRC CHK 1	'D'		'9'		
LRC CHK 0	'7'		'8'		
END 1	CR	LRC CHK 1	'D'		
END 0	LF	LRC CHK 0	'1'		
		END 1	CR		
		END 0	LF		

RTU mode:

Command message:		Response message:		Error response message	
ADR	01H	ADR	01H	ADR	01H
CMD	03H	CMD	03H	CMD	90H
Starting data address	01H	Number of data content	04H	Error code	02H
	01H		17H		CRC CHK LOW
Number of data (Word)	00H'		70H	CRC CHK HIGH	C1H
	02H	0102H content	08H		
CRC CHK Low	94H		98H		
CRC CHK High	37H	CRC CHK LOW	F8H		
		CRC CHK HIGH	36H		

- Command code: 06H, write a word

For example, writing 6000(1770H) to address 0100H of AMD with address 01H.

ASCII mode:

Command message:

STX	'.'
ADR 1	'0'
ADR 0	'1'
CMD 1	'0'
CMD 0	'6'
data	'0'
starting address	'1'
	'0'
	'0'
data	'1'
	'7'
	'7'
	'0'
LRC CHK 1	'7'
LRC CHK 0	'1'
END 1	CR
END 0	LF

Response message:

STX	'.'
ADR 1	'0'
ADR 0	'1'
CMD 1	'0'
CMD 0	'6'
data	'0'
starting address	'1'
	'0'
	'0'
data	'1'
	'7'
	'7'
	'0'
LRC CHK 1	'7'
LRC CHK 0	'1'
END 1	CR
END 0	LF

Error response message

STX	'.'
ADR 1	'0'
ADR 0	'1'
CMD 1	'8'
CMD 0	'6'
Error code	'0'
	'2'
LRC CHK 0	'6'
LRC CHK 1	'D'
END 1	CR
END 0	LF

RTU mode:

Command message:

ADR	01H
CMD	06H
data	01H
Starting address	00H
data	17H
	00H
CRC CHK LOW	87H
CRC CHK HIGH	C6H

Response message:

ADR	01H
CMD 1	06H
data	01H
Starting address	00H
data	17H
	70H
CRC CHK LOW	87H
CRC CHK HIGH	C6H

Error response message

ADR	01H
CMD 1	86H
Error code	02
CRC CHK LOW	C3H
CRC CHK HIGH	A1H

- Command code: 08H, loop detection

This command is used to test the communication condition between master control equipment (usually is PC or PLC) and AC drive. AC drive will deliver the data that received from AC drive to master control equipment.

For example:

ASCII mode:

Command message:		Response message:		Error response message	
STX	'.'	STX	'.'	STX	'.'
ADR 1	'0'	ADR 1	'0'	ADR 1	'0'
ADR 0	'1'	ADR 0	'1'	ADR 0	'1'
CMD 1	'0'	CMD 1	'0'	CMD 1	'8'
CMD 0	'8'	CMD 0	'8'	CMD 0	'8'
data	'0'	data	'0'	Error code	'0'
Starting address	'0'	Starting	'0'		'2'
	'0'		'0'	LRC CHK 0	'6'
	'0'		'0'	LRC CHK 1	'D'
data	'1'	data	'1'	END 1	CR
	'7'		'7'	END 0	LF
	'7'		'7'		
	'0'		'0'		
LRC CHK 1	'7'	LRC CHK 1	'7'		
LRC CHK 0	'0'	LRC CHK 0	'0'		
END 1	CR	END 1	CR		
END 0	LF	END 0	LF		

RTU mode:

Command message:		Response message:		Error response message	
ADR	01H	ADR	01H	ADR	01H
CMD	08H	CMD 1	08H	CMD 1	88H
data	00H	data	00H	Error code	02
Starting address	00H	Starting address	00H	CRC CHK LOW	E0H
data	17H	data	17H	CRC CHK HIGH	6DH
	70H		70H		
CRC CHK LOW	EEH	CRC CHK LOW	EEH		
CRC CHK HIGH	1FH	CRC CHK HIGH	1FH		

- Command code: 10H, write continuous words

For example, modify multi-step speed setting of AC drive (address 01H)
 05-00=50.00(1388H) · 05-01=40.00(0FA0H)

ASCII mode:

Command message:

STX	'.'
ADR 1	'0'
ADR 0	'1'
CMD 1	'1'
CMD 0	'0'
Data	'0'
Starting address	'5'
	'0'
	'0'
Number Of data (Word)	'0'
	'0'
	'0'
	'2'
Number of data (Byte)	'0'
	'4'
The first data	'1'
	'3'
	'8'
	'8'
The second data	'0'
	'F'
	'A'
	'0'
LRC CHK 1	'9'
LRC CHK 0	'A'
END 1	CR
END 0	LF

Response message:

STX	'.'
ADR 1	'0'
ADR 0	'1'
CMD 1	'1'
CMD 0	'0'
Data address	'0'
	'5'
	'0'
	'0'
Number Of data (Word)	'0'
	'0'
	'0'
	'0'
	'2'
LRC CHK 1	'E'
LRC CHK 0	'8'
END 1	CR
END 0	LF

Error response message

STX	'.'
ADR 1	'0'
ADR 0	'1'
CMD 1	'9'
CMD 0	'0'
Error code	'0'
	'2'
LRC CHK 0	'6'
LRC CHK 1	'D'
END 1	CR
END 0	LF

RTU mode:

Command message:

ADR	01H
CMD	10H
Data starting address	05H
	00H
Number of data (Word)	00H
	02H
Number of data (Byte)	04
The first data	13H
	88H
The second data	0FH
	A0H
CRC CHK LOW	4DH
CRC CHK HIGH	D9H

Response message:

ADR	01H
CMD 1	10H
Data starting address	05H
	00H
Number of data (Word)	00H
	02H
CRC CHK LOW	41H
CRC CHK HIGH	04H

Error response message

ADR	01H
CMD 1	90H
Error	02H
CRC CHK LOW	CDH
CRC CHK HIGH	C1H

3.4 CHK (check sum)

ASCII mode:

LRC (Longitudinal Redundancy Check) is calculated by summing up, module 256, the values of the bytes from ADR1 to last data character then calculating the hexadecimal representation of the 2's complement negation of the sum.

For example, reading 1 word from address 0401H of the AC drive with address 01H.

STX	'.'
ADR 1	'0'
ADR 0	'1'
CMD 1	'0'
CMD 0	'3'
Data starting address	'0'
	'4'
	'0'
	'1'
Number of data	'0'
	'0'
	'0'
	'1'
LRC CHK 1	'F'
LRC CHK 0	'6'
END 1	CR
END 0	LF

01H+03H+04H+01H+00H+01H=0AH, 2's complement of 0AH is **F6H**.

RTU mode:

RTU mode uses CRC (Cyclical Redundancy Check) detect value. CRC (Cyclical Redundancy Check) is calculated by the following steps:

- Step 1: Load a 16-bit register (called CRC register) with FFFFH.
- Step 2: Exclusive OR the first 8-bit byte of the command message with the low order byte of the 16-bit CRC register, putting the result in the CRC register.
- Step 3: Examine the LSB of CRC register.
- Step 4: If the LSB of CRC register is 0, shift the CRC register one bit to the right with MSB zerofilling, then repeat step 3. If the LSB of CRC register is 1, shift the CRC register one bit to the right with MSB zerofilling, Exclusive OR the CRC register with the polynomial value A001H, then repeat step 3.
- Step 5: Repeat step 3 and 4 until eight shifts have been performed. When this is done, a complete 8-bit byte will have been processed.

Step 6: Repeat step 2 to 5 for the next 8-bit byte of the command message.

Continue doing this until all bytes have been processed. The final contents of the CRC register are the CRC value. When transmitting the CRC value in the message, the upper and lower bytes of the CRC value must be swapped, i.e. the lower order byte will be transmitted first.

For example, read 2 words from the to address 2102H of AMD with address 01H. The CRC register content of last byte from ADR to number of data is F76FH. The command message is as following. 6FH will transmit before F7H.

Command message:

ADR	01H
CMD	03H
Data starting address	02H
Number of data (word)	00H
	02H
CRC CHK Low	6FH
CRC CHK High	F7H

The following is an example of CRC generation using C language. The function takes two arguments:

Unsigned char* data ← a pointer to the message buffer

Unsigned char length ← the quantity of bytes in the message buffer

The function returns the CRC values as a type of unsigned integer.

```

unsigned int crc_chk(unsigned char* data, unsigned char length){
    int j;
    unsigned int reg_crc=0xFFFF;
    while(length--){
        reg_crc ^= *data++;
        for(j=0;j<8;j++){
            if(reg_crc & 0x01){ /* LSB(b0)=1 */
                reg_crc=(reg_crc>>1) ^ 0xA001;
            }else{
                reg_crc=reg_crc >>1;
            }
        }
    }
    return reg_crc;
}

```

3.5 Address List

The contents of available addresses are shown as below:

Content	Address	Function
AC drive Parameters	GGnnH	GG means parameter group, nn means parameter number, for example, the address of Pr 04-01 is 0401H. Referencing to chapter 5 for the function of each parameter. When reading parameter by command code 03H, only one parameter can be read at one time.
Command Write only	2000H	Bit 0-1 00B: No function 01B: Stop 10B: Run 11B: Jog + Run
		Bit 2-3 Reserved
		Bit 4-5 00B: No function 01B: FWD 10B: REV 11B: Change direction
		Bit 6-7 00B: Comm. forced 1st accel/decel 01B: Comm. forced 2nd accel/decel 10B: Comm. forced 3rd accel/decel 11B: Comm. forced 4th accel/decel
		Bit 8-11 Represented 16 step speeds.
		Bit 12 0: No comm. multi step speed or accel/decel time 1: Comm. multi step speed or accel/decel time
		Bit 13-15 Reserved
	2001H	Frequency command
	2002H	Bit 0 1: EF (external fault) on
		Bit 1 1: Reset
Bit 2 1: External Base Block (B.B) on 0: External Base Block (B.B) off		
Status monitor Read only	2100H	Error code:
		00: No fault occurred
		01: Over-current (oc)
		02: Over-voltage (ov)
		03: Overheat (oH)
		04: Overload (oL)
		05: Electronic thermal relay (oL1)
		06: EF (external fault)
		07: AC drive IGBT fault (occ)
		08: CPU failure (cF3)
		09: Hardware protection failure (HPF)
		10: Over current during acceleration (ocA)
		11: Over current during deceleration (ocd)
		12: Over current during steady state operation (ocn)
13: Ground Fault (GFF)		

Content	Address	Function	
		14: Under voltage (Lv)	
		15: EEPROM WRITE failure (cF1)	
		16: EEPROM READ failure (cF2)	
		17: Base Block (bb)	
		18: Motor over load (oL2)	
		19: Reserved	
		20: Software or password protection (codE)	
		21: External emergency stop (EF1)	
		22: Phase-Loss (PHL)	
		23: Low current (Lc)	
		24: Feedback loss (FbL)	
		25: Reserved	
		26: FAnP (Fan Power Fault)	
		27: FF1 (Fan 1 Fault)	
		28: FF2 (Fan 2 Fault)	
		29: FF3 (Fan 3 Fault)	
		30: FF123 (Fan 1, 2, 3 Fault)	
		31: FF1, 2 (Fan 1, 2 Fault)	
		32: FF1, 3 (Fan 1, 3 Fault)	
		33: FF2, 3 (Fan 2, 3 Fault)	
		34: Gate Drive Low Voltage Protect (Fv)	
		Status of AC drive	
	2101H	Bit 0-1	00: Run LED is off and STOP led is on. (AC Drive stopping)
			01: RUN LED is blink and STOP led is on. (AC Drive deceleration to stop)
			10: RUN LED is on and STOP led is blink. (AC Drive standby)
			11: RUN LED is on and STOP led is off. (AC Drive running)
		Bit 2	Jog on
		Bit 3~4	00: REV LED is off and FWD led is on. (Forward)
			01: REV LED is blink and FWD led is on. (Reverse to Forward)
			10: REV LED is on and FWD led is blink. (Forward to Reverse)
			11: REV LED is on and FWD led is off. (Reverse)
		Bit 5~7	Reserved
		Bit 8	1: Master frequency source via communication interface
		Bit 9	1: Master frequency source via analog signal
		Bit 10	1: Running command via communication interface
		Bit 11	1: Parameter locked
		Bit 12	Reserved
	Bit 13	Reserved	
	Bit 14-15	Reserved	

Content	Address	Function
	2102H	Frequency command (F)
	2103H	Output frequency (H)
	2104H	Output current (AXXX.X)
	2105H	DC-BUS Voltage (UXXX.X)
	2106H	Output voltage (EXXX.X)
	2107H	Output power factor (n)
	2108H	Output power (XX.XXKW)
	2109H	Feedback signal actual value
	210AH	Feedback signal (XXX.XX %)
	210BH	Estimated torque ratio (XXX.X)
	210CH	User Target Value (Low bit) uL 0-99.99
	210DH	User Target Value (High bit) uH 0-9999
	210EH	PLC time
	220FH	Reserved

3.6 Exception response

The AC motor drive is expected to return a normal response after receiving command messages from the master device. The following depicts the conditions when no normal response is replied to the master device.

The AC motor drive does not receive the messages due to a communication error; thus, the AC motor drive has no response. The master device will eventually process a timeout condition.

The AC motor drive receives the messages without a communication error, but cannot handle them. An exception response will be returned to the master device and an error message "CExx" will be displayed on the keypad of AC motor drive. The xx of "CExx" is a decimal code equal to the exception code that is described below.

In the exception response, the most significant bit of the original command code is set to 1, and an exception code which explains the condition that caused the exception is returned.

Example of an exception response of command code 06H and exception code 02H:

ASCII mode

STX	':'
Address	'0'
	'1'
Function	'8'
	'6'
Exception code	'0'
	'2'
LRC CHK	'7'
	'7'
END	CR
	LF

RTU mode

Address	01H
Function	86H
Exception code	02H
CRC CHK Low	C3H
CRC CHK High	A1H

The explanation of exception codes:

Exception code	Explanation
01	Illegal function code: The function code received in the command message is not available for the AC motor drive.
02	Illegal data address: The data address received in the command message is not available for the AC motor drive.
03	Illegal data value: The data value received in the command message is not available for the AC drive.
04	Slave device failure: The AC motor drive is unable to perform the requested action.
10	Communication time-out: If Pr.09-03 is not equal to 0.0, Pr.09-02=00~02, and there is no communication on the bus during the Time-out detection period (set by Pr.09-03), "cE10" will be shown on the keypad.

5.11 Group 10: PID Control Parameters

10 - 00 Input Terminal for PID Feedback Factory Setting: 00

- Settings
- 00: No function
 - 01: Input via AVI
 - 02: Input via ACI1
 - 03: Input via ACI2
 - 04: Input via External Reference

This parameter is to set the source of PID control feedback signal. The source could be AVI, ACI1, ACI2 or external reference that defined by 04-24.

When this parameter is set to 00, PID feedback control function is disabled.

When this parameter is set to 02/03 and analog input current of ACI1/ACI2 is lower than Pr.04-13/Pr.04-17, EF warning will pup-up.

If this parameter isn't set to 00, AC drive will automatically start-up PID feedback control. Output frequency is calculated by master frequency and PID feedback signal.

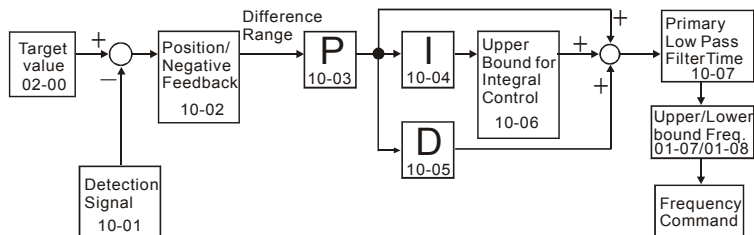

10 - 01 PID Control Detection Signal Reference Factory Setting: 1000.0

- Settings 0.0-6550.0 Unit: 0.1

Please refer to 04-09 to 04-20 if this parameter is set to PID feedback control.

10 - 02 PID Feedback Control Method Factory Setting: 00

- Settings
- 00: Negative feedback control
 - 01: Positive feedback control

This parameter could set the calculation method of deviation signal during PID feedback control circuit.

When this parameter is set to 00: when negative feedback control, the deviation equation is deviation = target value – detection signal. When increasing output frequency will increase detection value, this setting should be chose.

 When this parameter is set to 01: when positive control, the deviation equation is deviation = detection signal – target value. When increasing output frequency will decrease detection value, this setting should be chose.

10 - 03	Proportional Gain (P)	Factory Setting: 1.0
Settings	0.0~10.0	Unit: 0.1

 This parameter is to set proportional gain (P). This gain determines the response degree of P controller to feedback deviation. If gain value is large, the response is fast. But if the gain value is too great, oscillation will occur. If gain value is small, the response is slow.

10 - 04	Integral Time (I)	Factory Setting: 1.00
Settings	0.00~100.00 Sec	Unit: 0.01

 This parameter is set to integral gain of I controller. When much integral time is to be set, the gain of I controller is small and the response is slow. The control ability to external is poor. When less integral time is to be set, the gain of I controller is large and the response is fast. The control ability to external is fast.

 If the setting of integral time is too small, output frequency and system may occur oscillation.

 If integral time is set to 0.00, I controller is closed.

10 - 05	Differential Time (D)	Factory Setting: 0.00
Settings	0.00~1.00 Sec	Unit: 0.01

 This parameter is set to D controller gain. This gain determines D controller to the response of change of deviation. Suitable differential time could decrease overshoot of P and I controller. The oscillation will be attenuation and steady quickly. But if much differential time is to be set, it may cause system oscillation.

 Interference immunity ability is poor due to differential controller activates to change of deviation. It's not recommended to use, especially during interferences.

10 - 06	Upper Bound for Integral Control	Factory Setting: 100
Settings	00~200%	Unit: 1

 This parameter could set the upper bound of I controller. In other words, upper bound for integral control = (01-00) X (10-04) %

10 - 07	Primary Low Pass Filter Time	Factory Setting: 0.0
Settings	0.0~2.5 Sec	Unit: 0.1

 This parameter determines primary Low Pass filter time.

Output frequency of PID controller will filter by primary low pass function. This function could decrease change of output frequency. A long primary low pass time means filter degree is high and vice versa.

Unsuitable primary low pass filter time setting may cause system oscillation.

10 - 08	PID Feedback Signal Range	Factory Setting: 600.0
	Settings 0.0~6550.0	Unit:0.1

This parameter setting could allow the maximum of PID deviation.

If PID function is normal, it should control the detective value to target value accurately in the certain time. If AC drive can't control deviation in the 10-08 setting range during 10-09 setting time, FbL warning will pup-up and it means PID feedback control is abnormal. The treatment is set as 10-10.

10 - 09	PID Feedback Signal Fault Treatment Time	Factory Setting: 0.0
	Settings 0.0~3600.0 Sec	Unit: 0.1

This parameter is to set the detection time of abnormal PID derivative. If PID deviation detection time is set to 0.0, the function is disabled.

10 - 10	PID Feedback Signal Fault Treatment	↗	Factory Setting: 01
	Settings 00: Warn and RAMP stop		
	01: Warn and COAST stop		
	02: Warn and keep operating		

This parameter is to set treatment of the abnormal PID deviation.

10 - 11	PID Minimum Output Frequency	↗	Factory Setting: 01
	Settings 0: By PID controller		
	1: By AC drive		

This parameter can decide the source of PID output minimum frequency when AC drive enters PID sleep process. If it is set to 0, minimum output frequency should be set by PID. If it is set to 1 and 01-08 is 0, the output frequency is equal to the value of 01-05 setting. If it is set to 1 and 01-08 is not 0, the output frequency is equal to the value of 01-08 setting.

5.12 Group 11: Fan and Pump Control Parameters

11 - 00 V/f Curve Selection

Factory Setting: 00

- Settings
- 00: Determined by group 1
 - 01: 1.5 power curve
 - 02: 1.7 power curve
 - 03: 2 power curve
 - 04: cube curve

- This parameter is to set V/f curve. If this parameter isn't set to 00, parameter 01-03 and 01-04 will disable.
- Input current of the motor could divide into two orthogonal vectors: magnetic vector and torque vector. Gap flux, which is produced by Magnetic vector, is in direct proportion with output voltage of motor. Torque vector produces torque. Torque is in direct proportion with the result of magnetic vector multiply by torque vector. In theory, if the value of magnet vector is the same with torque vector (in unsaturated flux condition), the input current is minimum. If motor loading is unsteady torque loading (loading torque is in direct proportion with speed. For example, the loading of fan or pump), loading torque is low during low speed, suitable lower input voltage will decrease input current of magnetic field to lower flux loss and iron loss of the motor and promote whole efficiency.
- When this parameter is set to high power V/f curve and low frequency torque is lower, it is not suitable for AC drive to accel/decel quickly. If it needs to accel/decel quickly, it is not recommended to use this parameter.

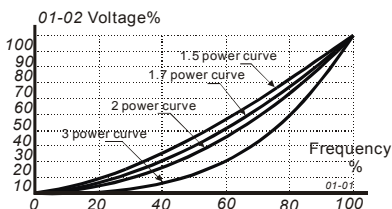

V/f Curve Diagram

11 - 01 Circulative Control

Factory Setting: 00

- Settings
- 00: No function
 - 01: Time circulation (by time)
 - 02: Fixed amount circulation (by PID)
 - 03: Fixed amount control (an AC drive runs with 4 motors)

- This parameter is to set an AC drive runs with multiple motors in circulation control mode.

When Pr. 11-01 is set to 01 Time Circulation. Starts a motor, runs it for a fixed amount of time Pr. 11-03 stops it (this motor will coast to stop), wait for delay time on Pr. 11-04, then starts the next motor, runs it for fixed amount of time, etc. Operates like an alternator (also notice that the Pr.11-03 time includes both the acceleration time and the running time).

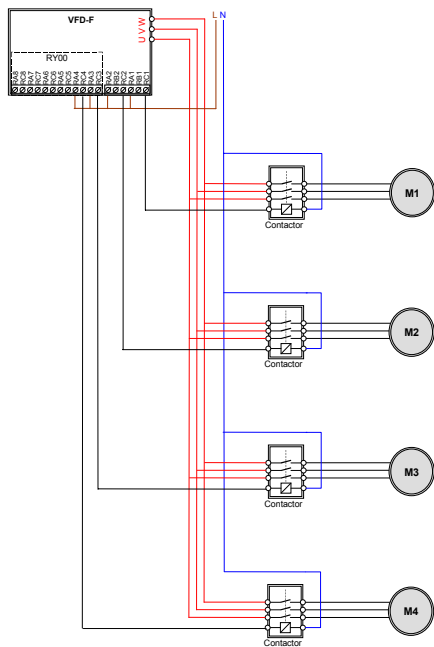
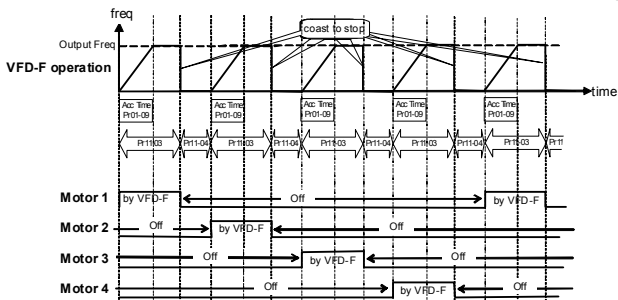

When Pr. 11-01 is set to 02 "Fixed Amount Circulation" and adding relay card "RY-00", VFD-F is able to drive 4 motors under PID control mode by turns.

System powers up, VFD-F drives 1st motor as PID control mode. If VFD-F output frequency continually surpasses 11-06 frequency setting and 11-05 time period, after time lag of 11-04, VFD-F will switch 1st motor power supply to commercial power and energize 2nd motor. At this time, 1st motor is full power running and 2nd motor is running PID control mode by VFD-F.

Previous routine repeats to 2nd motor→3rd motor→4th motor till VFD-F reaches proper PID values. VFD-F only runs PID control mode to last motor, others run full power.

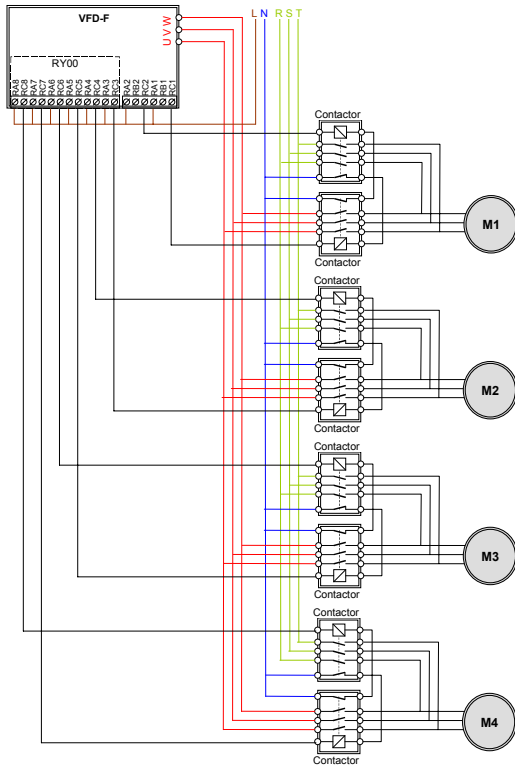

When Pr. 11-01 is set to 03 “Fixed Amount Control” and adding relay card “RY-00”, VFD-F is able to drive 1 motor under PID control mode and another 4 motors as full power running. System powers up, VFD-F drives 1st motor as PID control mode. If VFD-F output frequency continually surpasses 11-06 frequency setting and 11-05 time period, after time lag of 11-04, VFD-F will energize 2nd motor as full power running and 1st motor is still running PID control mode by VFD-F.

When 1st and 2nd motors are running, if VFD-F output frequency continually surpasses 11-06 frequency setting and 11-05 time period, after time lag of 11-04, VFD-F will energize 3rd motor as full power running and 1st motor is still running PID control mode by VFD-F. At this time, 2nd and 3rd motors are full power running.

Previous routine repeats to 3rd motor→4th motor→5th motor till VFD-F reaches proper PID values. VFD-F only runs PID control mode to 1st motor, others run full power.

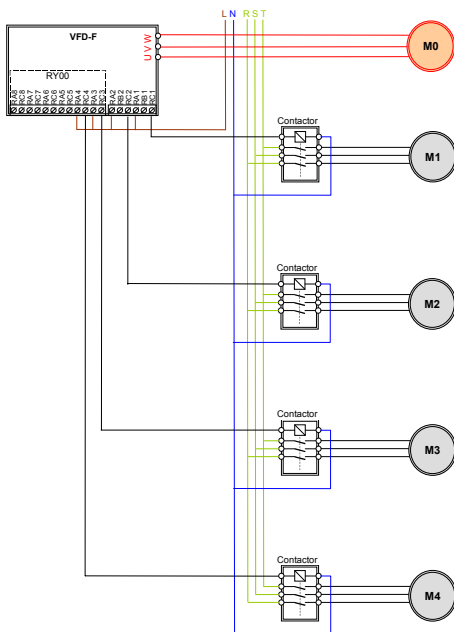

When this parameter isn't set to 00, 03-00 to 03-07 multi-function terminals will automatically set the corresponding output motor.

11 - 02 Multiple Motors Control

Factory Setting: 01

Settings 01~04

When this parameter is set to multiple motors control, multi-function terminals 03-00 to 03-07 will automatically set to suitable value. Users need to connect output terminal correctly to circulative control as shown in following chart.

11-01 Circulative Control	01 Time Circulation				02 Fixed Amount Circulation			
11-02 motors	01	02	03	04	01	02	03	04
03-00	01 Motor 1 runs by AC drive.	01 Motor 1 runs by AC drive.	01 Motor 1 runs by AC drive.	01 Motor 1 runs by AC drive.	01 Motor 1 runs by AC drive.	01 Motor 1 runs by AC drive.	01 Motor 1 runs by AC drive.	01 Motor 1 runs by AC drive.
03-01	N/A	02 Motor 2 runs by AC drive.	02 Motor 2 runs by AC drive.	02 Motor 2 runs by AC drive.	02 Motor 1 runs by commercial power.	02 Motor 1 runs by commercial power.	02 Motor 1 runs by commercial power.	02 Motor 1 runs by commercial power.
03-02	N/A	N/A	03 Motor 3 runs by AC drive.	03 Motor 3 runs by AC drive.	N/A	03 Motor 2 runs by AC drive.	03 Motor 2 runs by AC drive.	03 Motor 2 runs by AC drive.
03-03	N/A	N/A	N/A	04 Motor 4 runs by AC drive.	N/A	04 Motor 2 runs by commercial power.	04 Motor 2 runs by commercial power.	04 Motor 2 runs by commercial power.
03-04	N/A	N/A	N/A	N/A	N/A	N/A	05 Motor 3 runs by AC drive.	05 Motor 3 runs by AC drive.
03-05	N/A	N/A	N/A	N/A	N/A	N/A	06 Motor 3 runs by commercial power.	06 Motor 3 runs by commercial power.
03-06	N/A	N/A	N/A	N/A	N/A	N/A	N/A	07 Motor 4 runs by AC drive.
03-07	N/A	N/A	N/A	N/A	N/A	N/A	N/A	08 Motor 4 runs by commercial power.

5
11 - 03 Time Circulation Time Setting

Factory Setting: 00

Settings 00~65500 Min

Unit: 1 Min

This parameter is to set running time of each motor (including acceleration time) when multiple motors are in time circulation mode (11-01=1). If this parameter is set to 00, time setting is disabled and run with a motor.

If multi-function input terminals (04-00 to 04-07) are set to 27 to 31, the corresponding output terminals will skip and not activate. The following diagram is the action schedule of time circulation when motor 3 is disabled.

The motor, which is running with AC drive doesn't accept any disable command of motor.

When switching time circulation, AC drive won't provide this selection when running motor is coast to stop.

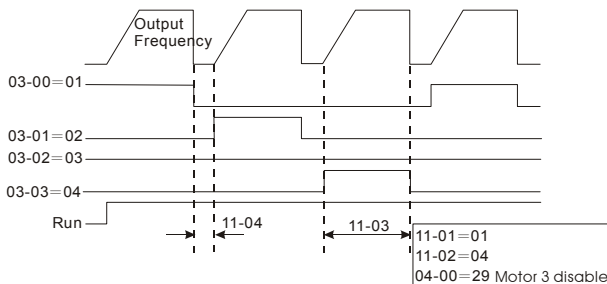

11 - 04 Motor Switch Delay Time

Factory Setting: 1.0

Settings 0.0~3600.0 sec

Unit: 0.1

This parameter determines time interval of two motors during circulative control (11-01=01). Users need to set suitable time delay to avoid water hammer effect damaging AC drive, motor or system.

This parameter determines time interval between power supply changes from AC drive to commercial power during fixed circulative control (11-01=02). Users need to set the suitable time delay to make no shock to motor and runs by commercial power.

11 - 05 Motor Switch Delay Time during Fixed Amount Circulation

Factory Setting: 10.0

Settings 0.0~3600.0 sec

Unit: 0.1

This parameter determines time interval between motor switch frequency and power supply of motor is not from AC drive during fixed amount circulation (11-01=02)/fixed amount control (11-01=03) and output frequency of AC drive attained.

As the diagram shown below, after output frequency attains 11-06 motor switch frequency, motor doesn't switch at once. It will do motor switch action of circulation control after waiting the delay time that is set by 11-05. Suitable delay time setting will decrease motor switch times.

- After power supply of motor is not from AC drive, the motor will coast to stop according to loading characteristics. Users need to set 11-06 motor switch frequency and 11-04 delay time of circulation control according to actual situation to make rotor speed equals to commercial frequency.

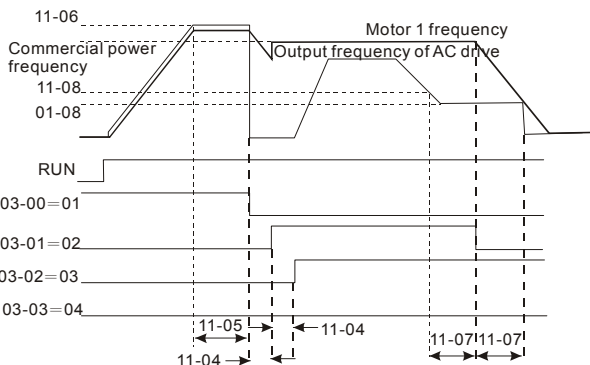

11 - 06

Motor Switch Frequency during Fixed Amount Circulation

Factory Setting: 60.00 Hz

Settings 0.00 to 120.00 Hz

Unit: 0.01Hz

- This parameter determines frequency that motor runs by commercial power during fixed amount circulation (11-01=02)/fixed amount control (11-01=03). This parameter should be greater than commercial frequency. If output frequency of AC drive attains to motor switch frequency, it means that even motor runs in full speed it can't make detection value of PID control attains to target value. Therefore, the power supply of the motor needs to be changed from AC drive to commercial power. AC drive runs with the next motor and makes the detection value close to target.

- In the following chart

T1: enter sleep process time (Pr.11-07)

T2: motor switch delay time during fixed amount circulation (Pr.11-05)

T3: motor switch delay time (Pr.11-04)

N: motor 1

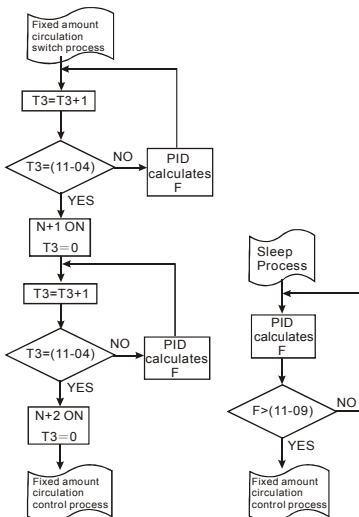
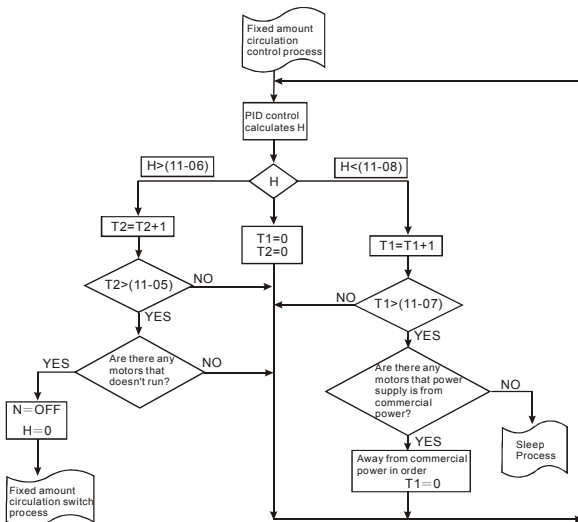

11 - 07 Enter Sleep Process Time

Factory Setting: 0.0

Settings 0.0~3600.0sec

Unit: 0.1 Sec

- 📖 This parameter is to set output frequency of AC drive being smaller than the time interval between sleep frequency and enter sleep process.
- 📖 When AC drive starts running, frequency command calculated by PID is smaller than sleep frequency. AC drive will enter sleep status and won't be limited by this parameter.
- 📖 When AC motor drive is in sleep process, SLEEP will be displayed on the digital keypad till frequency command attains to wake up frequency.

11 - 08 Sleep Frequency of Sleep Process

Factory Setting: 0.00

Settings 0.00~11-09 (wake up frequency)

Unit: 0.01

- 📖 This parameter determines frequency after AC drive enters sleep process.
- 📖 After AC drive enters sleep status, it will stop to output signal but PID controller will keep working.

11 - 09 Wake Up Frequency of Sleep Process

Factory Setting: 0.00

Settings 0.00 to 120.00Hz

Unit: 0.01

- 📖 This parameter determines wake up frequency after AC drive enters sleep process.
- 📖 PID control function will keep calculating frequency command (F) when AC drive is in sleep process. When frequency command attains to wake up frequency, AC drive will accelerate from 01-05 minimum frequency setting according to V/f curve.
- 📖 The setting of wake up frequency needs to be greater than sleep frequency.

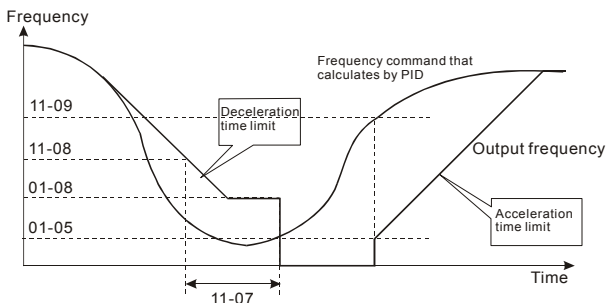

11 - 10 Treatment of Fixed Amount Circulation Malfunction Factory Setting: 00

Settings 00: Turn off all motors
 01: Turn off AC drive

 This parameter determines treatment of AC drive malfunction during fixed amount circulation.

 When AC drive occurs power circuit malfunction to make auxiliary power disable and microprocessor can't work, all output will close automatically.

11 - 11 Stop Frequency of Auxiliary Motor Factory Setting: 0.00

Settings 0.00~120.00Hz Unit: 0.01Hz

 If output frequency of AC drive is less than or equal to this parameter when AC drive is fixed amount circulation (11-01=02) or fixed amount (11-01=03), AC drive will make motor stop in sequence.

CHAPTER 6 MAINTENANCE AND INSPECTIONS

Modern AC drives are based on solid state electronics technology, preventive maintenance is required to operate this AC drive in its optimal condition, and to ensure a long life. It is recommended to perform a monthly check up of the AC drive by a qualified technician. Before the check up, always turn off the AC Input Power to the unit. ***Wait at least 10 minutes after all display lamps have gone out, and then confirm that the capacitors have fully discharged by measuring the voltage between B1 and Ground using a multimeter set to measure DC.***

6.1 Periodic Inspection

Basic check up items to detect if there were any abnormality during the operation:

1. Whether the motors are operating as expected.
2. Whether the installation environment is abnormal.
3. Whether the cooling system is operating as expected.
4. Whether any irregular vibration or sound occurred during the operation.
5. Whether the motors are overheated during the operation.
6. Always check the input voltage of the AC drive with Voltmeter.

6.2 Periodic Maintenance

 **WARNING!** Disconnecting AC power before processing!

1. Tighten and reinforce the screws of the AC drive if necessary, cause it may loose due to the vibration or changing of temperatures.
2. Whether the conductors or insulators were corroded and damaged.
3. Check the resistance of the insulation with Meg-ohmmeter.
4. Often check and change the capacitors and relays.
5. If use of the AC drive is discontinued for a long period of time, turn the power on at least once every two years and confirm that it still functions properly. To confirm functionality, disconnect the motor and energize the AC drive for 5 hours or more before attempting to run a motor with it.
6. Clean off any dust and dirt with a vacuum cleaner. Place special emphasis on cleaning the ventilation ports and PCBs. Always keep these areas clean, as accumulation of dust and dirt can cause unforeseen failures.

This page intentionally left blank.

CHAPTER 7 Troubleshooting and Fault Information

The AC drive has a comprehensive fault diagnostic system that includes several different alarms and fault messages. Once a fault is detected, the corresponding protective functions will be activated. The following faults are displayed as shown on the AC drive digital keypad display. The four most recent faults can be read on the digital keypad display.

NOTE: Faults can be cleared by a reset from the keypad or Input Terminal.

Common Problems and Solutions:

Fault Name	Fault Descriptions	Corrective Actions
OC	The AC drive detects an abnormal increase in current.	<ol style="list-style-type: none"> 1. Check whether the motors horsepower corresponds to the AC drive output power. 2. Check the wiring connections between the AC drive and motor for possible short circuits. 3. Increase the Acceleration time. 4. Check for possible excessive loading conditions at the motor. 5. If there are any abnormal conditions when operating the AC drive after short-circuit being removed, it should be sent back to manufacturer.
OU	The AC drive detects that the DC bus voltage has exceeded its maximum allowable value.	<ol style="list-style-type: none"> 1. Check whether the input voltage falls within the rated AC drive input voltage. 2. Check for possible voltage transients. 3. Bus over-voltage may also be caused by motor regeneration. Either increase the decel time or add an optional brake resistor. 4. Check whether the required brake power is within the specified limits.

7

Fault Name	Fault Descriptions	Corrective Actions
OH	The AC drive temperature sensor detects excessive heat.	<ol style="list-style-type: none"> 1. Ensure that the ambient temperature falls within the specified temperature range. 2. Make sure that the ventilation holes are not obstructed. 3. Remove any foreign objects on the heatsinks and check for possible dirty heat sink fins. 4. Provide enough spacing for adequate ventilation.
LU	The AC drive detects that the DC bus voltage has fallen below its minimum value.	Check whether the input voltage falls within the rated AC drive's input voltage.
OL	<p>The AC drive detects excessive drive output current.</p> <p>Note: The AC drive can withstand up to 150% of the rated current for a maximum of 60 seconds.</p>	<ol style="list-style-type: none"> 1. Check whether the motor is overloaded. 2. Reduce torque compensation setting as set in Pr.7-02. 3. Increase the AC drive's output capacity.
OL1	Internal electronic overload trip	<ol style="list-style-type: none"> 1. Check for possible motor overload. 2. Check electronic thermal overload setting. 3. Increase motor capacity. 4. Reduce the current level so that the drive output current does not exceed the value set by the Motor Rated Current Pr.7-00.
OL2	Motor overload. Check the parameter settings (Pr.6-03 to Pr.6-05)	<ol style="list-style-type: none"> 1. Reduce the motor load. 2. Adjust the over-torque detection setting to an appropriate setting (Pr.06-03 to Pr.06-05).
HPF1	GFF hardware error	Return to the factory.
HPF2	CC (Current Clamp)	Return to the factory.

Fault Name	Fault Descriptions	Corrective Actions
HPF3	OC hardware error	Return to the factory.
HPF4	OV hardware error	Return to the factory.
HPF5	OH hardware error	Return to the factory.
CE--	Communication Error	<ol style="list-style-type: none"> 1. Check the connection between the AC drive and computer for loose wires. 2. Check if the communication protocol is properly set.
ocA	Over-current during acceleration: <ol style="list-style-type: none"> 1. Short-circuit at motor output. 2. Torque boost too high. 3. Acceleration time too short. 4. AC drive output capacity is too small. 	<ol style="list-style-type: none"> 1. Check for possible poor insulation at the output line. 2. Decrease the torque boost setting in Pr.7-02. 3. Increase the acceleration time. 4. Replace with the AC drive with one that has a higher output capacity (next HP size).
ocd	Over-current during deceleration: <ol style="list-style-type: none"> 1. Short-circuit at motor output. 2. Deceleration time too short. 3. AC drive output capacity is too small. 	<ol style="list-style-type: none"> 1. Check for possible poor insulation at the output line. 2. Increase the deceleration time. 3. Replace with the AC drive with one that has a higher output capacity (next HP size).
ocn	Over-current during steady state operation: <ol style="list-style-type: none"> 1. Short-circuit at motor output. 2. Sudden increase in motor loading. 3. AC drive output capacity is too small. 	<ol style="list-style-type: none"> 1. Check for possible poor insulation at the output line. 2. Check for possible motor stall. 3. Replace with the AC drive with one that has a higher output capacity (next HP size).

Fault Name	Fault Descriptions	Corrective Actions
EF	Analog Signal Error	1. Check ACI wiring. 2. Check whether the input current of ACI is lower than Pr.04-13/04-17 setting.
EF1	Emergency stop. When the multi-function input terminals (MI1 to MI8) stop, AC drive stops any output.	Press RESET after fault has been cleared.
cF1	Internal memory IC cannot be programmed.	1. Return to the factory. 2. Check the EEPROM on the control board.
cF2	Internal memory IC cannot be read.	1. Return to the factory. 2. Reset drive to factory defaults.
cF33	U-phase error	Return to the factory.
cF34	V-phase error	Return to the factory.
cF35	W-phase error	Return to the factory.
cF36	OV or LV	Return to the factory.
cF37	Isum error	Return to the factory.
cF38	OH error	Return to the factory.
codeE	Software protection failure	Return to the factory.
cFA	Auto accel/decel failure	Don't use the function of auto acceleration /deceleration.

Fault Name	Fault Descriptions	Corrective Actions
OFF	Ground fault: The AC drive output is abnormal. When the output terminal is grounded (short circuit current is 50% more than the AC drive rated current), the AC drive power module may be damaged. The short circuit protection is provided for AC drive protection, not user protection.	Ground fault: 1. Check whether the IGBT power module is damaged. 2. Check for possible poor insulation at the output line.
bb	External Base Block. AC drive output is turned off.	1. When the external input terminal (B.B) is active, the AC drive output will be turned off. 2. Disable this connection and the AC drive will begin to work again.
FbL	PID Feedback Signal Error	1. Check parameter settings (Pr.10-00) and AVI/ACI1/ACI2 wiring. 2. Check for possible fault between system reaction time and the feedback signal detection time (Pr.10-08/Pr.10-09).
FAnP	Fan Power Fault (150~300HP)	Return to the factory.
FF1	Fan 1 fault (150~300HP)	Remove any foreign objects on the heatsinks and check for possible dirty heat sink fins.
FF2	Fan 2 fault (150~300HP)	Remove any foreign objects on the heatsinks and check for possible dirty heat sink fins.
FF3	Fan 3 fault (150~300HP)	Remove any foreign objects on the heatsinks and check for possible dirty heat sink fins.

Fault Name	Fault Descriptions	Corrective Actions
FF 123	Fan 1, 2, 3 fault (150~300HP)	Remove any foreign objects on the heatsinks and check for possible dirty heat sink fins.
FF 12	Fan 1, 2 fault (150~300HP)	Remove any foreign objects on the heatsinks and check for possible dirty heat sink fins.
FF 13	Fan 1, 3 fault (150~300HP)	Remove any foreign objects on the heatsinks and check for possible dirty heat sink fins.
FF23	Fan 2, 3 fault (150~300HP)	Remove any foreign objects on the heatsinks and check for possible dirty heat sink fins.
Fu	Gate Drive Low Voltage Protect	Return to the factory.

CHAPTER 8 PARAMETER SUMMARY

Group 0 AC Drive Status Parameter

Parameters	Functions	Settings	Factory Setting	Customer
00-00	Software Version	Read only		
00-01	AC Drive Status Indication 1	00: No Fault occurred 01: oc (over current) 02: ov (over voltage) 03: oH (over temperature) 04: oL (overload) 05: oL1 (electronic thermal relay) 06: EF (External Fault) 07: occ (AC drive IGBT fault) 08: cF3 (CPU failure) 09: HPF (Hardware Protection Failure) 10: ocA (current exceed during Acceleration) 11: ocd (current exceed during Deceleration) 12: ocn (current exceed during Steady State) 13: GFF (Ground Fault) 14: Lv (Low voltage) 15: cF1 (input data abnormal) 16: cF2 (output data abnormal) 17: bb (base block) 18: oL2 (over load2) 19: Reserved 20: codE (software or password protection) 21: EF1 (external emergency stop) 22: PHL (phase loss) 23: Lc (Low current) 24: FbL (Feedback loss) 25: Reserved 26: FAnP (Fan Power Fault) 27: FF1 (Fan 1 fault) 28: FF2 (Fan 2 fault) 29: FF3 (Fan 3 fault) 30: FF123 (Fan 1, 2, 3 fault) 31: FF12 (Fan 1, 2 fault) 32: FF13 (Fan 1, 3 fault) 33: FF23 (Fan 2, 3 fault) 34: Fv (Gate Drive Low Voltage Protect)	Read	

Parameters	Functions	Settings	Factory Setting	Customer
00-02	AC Drive Status Indication 2	Bit 0~1: 00: Run led is off and stop led is on. 01: Run led is blink and stop led is on. 10: Run led is on and stop led is blink. 11: Run led is on and stop led is off. Bit 2: 1: Jog on. Bit 3~4: 00: Rev led is off and FWD led is on. 01: Rev led is blink and FWD led is on. 10: Rev led is on and FWD led is blink. 11: Rev led is on and FWD led is off. Bit 5-7: Reserved Bit 8: Master frequency source via communication interface Bit 9: Master frequency source via analog Bit10: Running command via communication interface Bit11: Parameter locked Bit12~15: Reserved	Read	
00-03	Frequency Setting	Read only	Read	
00-04	Output Frequency	Read only	Read	
00-05	Output Current	Read only	Read	
00-06	DC-BUS Voltage	Read only	Read	
00-07	Output Voltage	Read only	Read	
00-08	Output Power Factor	Read only	Read	
00-09	Output Power (kW)	Read only	Read	
00-10	Feedback Signal Actual Value	Read only	Read	
00-11	Feedback Signal (%)	Read only	Read	
00-12	User Target Value (Low bit) uL 0-99.99	Read only	Read	
00-13	User Target Value (High bit) uH 0-9999	Read only	Read	
00-14	PLC time	Read only	Read	

Group 1 Basic Parameter (Twice the value for 460V class)

Parameters	Functions	Settings	Factory Setting	Customer
01-00	Maximum Output Frequency	50.00~120.00Hz	60.00	
01-01	Maximum Voltage Frequency (Base Frequency)	0.10~120.00 Hz	60.00	
01-02	Maximum Output Voltage	230V series: 0.1~255.0V 460V series: 0.2~510.0V	220.0 440.0	
01-03	Mid-point Frequency	0.10~120 Hz	1.50	
01-04	Mid-point Voltage	230V series: 0.1~255.0V 460V series: 0.2~510.0V	5.5 11.0	
01-05	Minimum Output Frequency	0.10~20.00 Hz	1.50	
01-06	Minimum Output Voltage	230V series: 0.1~50.0V 460V series: 0.2V~100.0V	5.5 11.0	
01-07	Upper Bound Frequency	0.00~120.00 Hz	60.00	
01-08	Lower Bound Frequency	0.00~120.00 Hz	0.00	
✓ 01-09	Acceleration Time 1	0.1~3600.0 Sec	10.0/ 60.0	
✓ 01-10	Deceleration Time 1	0.1~3600.0 Sec	10.0/ 60.0	
✓ 01-11	Acceleration Time 2	0.1~3600.0 Sec	10.0/ 60.0	
✓ 01-12	Deceleration Time 2	0.1~3600.0 Sec	10.0/ 60.0	
✓ 01-13	Acceleration Time 3	0.1~3600.0 Sec	10.0/ 60.0	
✓ 01-14	Deceleration Time 3	0.1~3600.0 Sec	10.0/ 60.0	
✓ 01-15	Acceleration Time 4	0.1~3600.0 Sec	10.0/ 60.0	
✓ 01-16	Deceleration Time 4	0.1~3600.0 Sec	10.0/ 60.0	
✓ 01-17	JOG Acceleration Time	0.1~3600.0 Sec	10.0/ 60.0	
✓ 01-18	JOG Deceleration Time	0.1~3600.0 Sec	10.0/ 60.0	
✓ 01-19	JOG frequency	0.0 Hz~120.00 Hz	6.00	
01-20	S Curve Delay Time in Accel	0.00~2.50sec	0.00	
01-21	S Curve Delay Time in Decel	0.00~2.50sec	0.00	
✓ 01-22	Modulation Index	0.90~1.20	1.00	
01-23	Accel/Decel Time Unit	00: Unit is 1 Sec 01: Unit is 0.1 Sec 02: Unit is 0.01 Sec	01	

Group 2 Digital Output/Input Parameter

Parameters	Functions	Settings	Factory Setting	Customer
✓ 02-00	Source of Frequency Command	00: via keypad 01: via analog input AVI 02: via analog input AC11 03: via analog input AC12 04: via RS485 serial communication 05: via External Reference	00	
✓ 02-01	Source of Operation Command	00: Controlled by the digital keypad 01: Controlled by the external terminals, keypad STOP enabled. 02: Controlled by external terminals, keypad STOP disabled. 03: Controlled by the RS-485 communication interface, keypad STOP enabled. 04: Controlled by the RS-485 communication interface, keypad STOP disabled.	00	
02-02	Stop Method	00: Stop = ramp to stop, E.F. (External Fault) = coast to stop 01: Stop = coast to stop, E.F. = coast to stop 02: Stop = ramp to stop, E.F. = ramp to stop 03: Stop = coast to stop, E.F. = ramp to stop	00	
✓ 02-03	PWM Carrier Frequency Selections	1~10HP: 4000~10000Hz 15~30HP: 3000~9000Hz ≥40HP: 2000~6000Hz	9000Hz 6000Hz 4000Hz	
02-04	Forward/Reverse Enable	00: Forward enabled 01: Reverse disabled 02: Forward disabled	00	
02-05	2-wire/3-wire Operation Control Modes	00: 2-wire (#1), FWD/STOP, REV/STOP 01: 2-wire (#2), RUN/STOP, REV/FWD 02: 3-wire	00	
02-06	Line Start Lockout	00: Disabled 01: Enabled	01	

Parameters	Functions	Settings	Factory Setting	Customer
02-07	Loss of ACI Signal	00: Decelerate to 0Hz 01: E.F. 02: Continue operation by the last frequency command	01	
✓ 02-08	Start-up Display Selection	Bit0~1: 00 = F LED 01 = H LED 10 = U LED (special display) 11 = Fwd / Rev Bit2: 0 = Fwd LED / 1 = Rev LED Bit3~5: 000 = 1st 7-step 001 = 2nd 7-step 010 = 3rd 7-step 011 = 4th 7-step 100 = 5th 7-step Bit6~7: Reserved	00	
✓ 02-09	Special Display	00: A displays output current of AC drive 01: U displays DC-Bus voltage of AC drive 02: E displays RMS of output voltage 03: P displays feedback Signal 04: PLC display auto procedure state	00	
✓ 02-10	User Defined Coefficient	0.01~160.00	1.00	
✓ 02-11	Flying Start	00: Disable 01: Enable (Dc brake disabled)	00	
✓ 02-12	Flying Start Frequency	00: Trace from master frequency command 01: Trace from maximum setting frequency 01-00	00	
✓ 02-13	Master Frequency Memory Setting	00: Do not remember the last known frequency 01: Remember the last known frequency	01	

Group 3 Output Function Parameters

Parameters	Functions	Settings	Factory Setting	Customer
03-00	Multi-function Output terminal 1	00: No function	00	
03-01	Multi-function Output terminal 2	01: Motor No.1	00	
03-02	Multi-function Output terminal 3	02: Motor No.2	00	
03-03	Multi-function Output terminal 4	03: Motor No.3	00	
03-04	Multi-function Output terminal 5	04: Motor No.4	00	
03-05	Multi-function Output terminal 6	05: Motor No.5	00	
03-06	Multi-function Output terminal 7	06: Motor No.6	00	
03-07	Multi-function Output terminal 8	07: Motor No.7	00	
		08: Motor No.8		
		09: Auxiliary 1 output		
		10: Auxiliary 2 output		
		11: Auxiliary 3 output		
		12: Auxiliary 4 output		
		13: Auxiliary 5 output		
		14: Auxiliary 6 output		
		15: Auxiliary 7 output		
		16: Indication during operation		
		17: Master frequency attained		
		18: Zero speed (including shutdown)		
		19: Over-torque		
		20: External fault		
		21: Low voltage detection		
		22: Operation mode indication		
		23: Fault indication		
		24: Master frequency attained 1		
		25: Master frequency attained 2		
		26: Over temperature indication		
		27: Drive ready		
		28: External emergency stop (EF1)		
		29: Software brake output		
		30: OL or OL1 overload warning		
		31: Dwell indication (sleep)		
		32: Low current indication		
		33: PID feedback error indication		
		34: PLC program running		
		35: PLC program step completed		
		36: PLC program completed		

Parameters	Functions	Settings	Factory Setting	Customer
		37: PLC program operation Paused		
03-08	Master Frequency Attained 1	0.00~120.00 Hz	0.00	
03-09	Master Frequency Attained 2	0.00~120.00 Hz	0.00	
03-10	Analog Output 1, (AFM1) 0~10Vdc	00: Output frequency 01: Output current	00	
03-11	Analog Output 2, (AFM2) 0/4~ 20mA	02: Output voltage 03: Frequency command 04: Power factor loading	01	
✓	03-12	Analog Output Gain 1	01~200%	100
✓	03-13	Analog Output Gain 2	01~200%	100
	03-14	Analog Output 2 Selection (AFM2 Definition)	00: 0~20mA 01: 4~20mA	01
	03-15	DC Fan Control	00: Fan runs on power up. 01: Fan begins upon a RUN command. Fan stops 1 minute after a STOP command. 02: Fan begins upon a RUN command. Fan stops after a STOP command 03: Fan is controlled by temperature. Approximately a 60°C temperature will start the fan.	00

Group 4 Input Function Parameters

Parameters	Functions	Settings	Factory Setting	Customer
04-00	Multi-function Input terminal 1	00: No function	01	
04-01	Multi-function Input terminal 2	01: Multi-Speed terminal 1	02	
04-02	Multi-function Input terminal 3	02: Multi-Speed terminal 2	03	
04-03	Multi-function Input terminal 4	03: Multi-Speed terminal 3	04	
04-04	Multi-function Input terminal 5	04: Multi-Speed terminal 4	05	
04-05	Multi-function Input terminal 6	05: Reset (NO)	07	
04-06	Multi-function Input terminal 7	06: Reset (NC)	08	
04-07	Multi-function Input terminal 8	07: Jog operation (JOG) 08: Accel/Decel disable 09: Accel/Decel 2 selection 10: Accel/Decel 3 selection 11: B.B. (NO) input 12: B.B. (NC) input 13: Increase frequency 14: Decrease frequency 15: Emergency stop (NO) 16: Emergency stop (NC) 17: AVI(open), AC11(close) 18: KEYPAD(open), EXT(close) 19: PID disable 20: Auxiliary 1 input 21: Auxiliary 2 input 22: Auxiliary 3 input 23: Auxiliary 4 input 24: Auxiliary 5 input 25: Auxiliary 6 input 26: Auxiliary 7 input 27: Motor No.1 output disable 28: Motor No.2 output disable 29: Motor No.3 output disable 30: Motor No.4 output disable 31: All motor output disable 32: Run PLC program 33: Pause PLC program	09	
04-08	Digital Input Terminal Response Time	01~20	01	
04-09	AVI Minimum voltage	0.0~10.0V	0.0	
04-10	AVI Maximum voltage	0.0~10.0V	10.0	
04-11	AVI Minimum frequency (percentage of Pr.1-00)	0.00~100.00%	0.00	
04-12	AVI Maximum frequency (percentage of Pr.1-00)	0.00~100.00%	100.00	
04-13	AC11 Minimum current	0.0~20.0mA	4.0	
04-14	AC11 Maximum current	0.0~20.0mA	20.0	

Parameters	Functions	Settings	Factory Setting	Customer
04-15	ACI1 Minimum frequency (percentage of Pr.1-00)	0.0~100.0%	0.00	
04-16	ACI1 Maximum frequency (percentage of Pr.1-00)	0.0~100.0%	100.00	
04-17	ACI2 Minimum current	0.0~20.0mA	4.0	
04-18	ACI2 Maximum current	0.0~20.0mA	20.0	
04-19	ACI2 Minimum frequency (percentage of Pr.1-00)	0.00~100.00%	0.00	
04-20	ACI2 Maximum frequency (percentage of Pr.1-00)	0.00~100.00%	100.00	
04-21	Analog Input Delay AVI	0.00~10.00 Sec	0.50	
04-22	Analog Input Delay ACI1	0.00~10.00 Sec	0.50	
04-23	Analog Input Delay ACI2	0.00~10.00 Sec	0.50	
04-24	Summation of External Frequency Sources	00: No functions 01: AVI+ACI1 02: ACI1+ACI2 03: ACI2+AVI 04: Communication master frequency +AVI 05: Communication master frequency +ACI1 06: Communication master frequency +ACI2	00	

Group 5 Multi-step Speed Frequency Parameters

Parameters	Functions	Settings	Factory Setting	Customer
05-00	1 st Step Speed Frequency	0.00~120.00 Hz	0.00	
05-01	2 nd Step Speed Frequency	0.00~120.00 Hz	0.00	
05-02	3 rd Step Speed Frequency	0.00~120.00 Hz	0.00	
05-03	4 th Step Speed Frequency	0.00~120.00 Hz	0.00	
05-04	5 th Step Speed Frequency	0.00~120.00 Hz	0.00	
05-05	6 th Step Speed Frequency	0.00~120.00 Hz	0.00	
05-06	7 th Step Speed Frequency	0.00~120.00 Hz	0.00	
05-07	8 th Step Speed Frequency	0.00~120.00 Hz	0.00	
05-08	9 th Step Speed Frequency	0.00~120.00 Hz	0.00	
05-09	10 th Step Speed Frequency	0.00~120.00 Hz	0.00	
05-10	11 th Step Speed Frequency	0.00~120.00 Hz	0.00	
05-11	12 th Step Speed Frequency	0.00~120.00 Hz	0.00	
05-12	13 th Step Speed Frequency	0.00~120.00 Hz	0.00	
05-13	14 th Step Speed Frequency	0.00~120.00 Hz	0.00	
05-14	15 th Step Speed Frequency	0.00~120.00 Hz	0.00	
05-15	PLC Mode	00: Disable PLC operation 01: Execute one program cycle 02: Continuously execute program cycles 03: Execute one program cycle step by step 04: Continuously execute program cycles step by step	00	
05-16	PLC Forward/ Reverse Motion	00 to 32767 (00: FWD 01: REV)	00	
05-17	Time Duration Step 1	0.0 to 65500 sec	0.0	
05-18	Time Duration Step 2	0.0 to 65500 sec	0.0	
05-19	Time Duration Step 3	0.0 to 65500 sec	0.0	
05-20	Time Duration Step 4	0.0 to 65500 sec	0.0	
05-21	Time Duration Step 5	0.0 to 65500 sec	0.0	
05-22	Time Duration Step 6	0.0 to 65500 sec	0.0	
05-23	Time Duration Step 7	0.0 to 65500 sec	0.0	
05-24	Time Duration Step 8	0.0 to 65500 Sec	0.0	
05-25	Time Duration Step 9	0.0 to 65500 Sec	0.0	
05-26	Time Duration Step 10	0.0 to 65500 Sec	0.0	
05-27	Time Duration Step 11	0.0 to 65500 Sec	0.0	

Parameters	Functions	Settings	Factory Setting	Customer
05-28	Time Duration Step 12	0.0 to 65500 Sec	0.0	
05-29	Time Duration Step 13	0.0 to 65500 Sec	0.0	
05-30	Time Duration Step 14	0.0 to 65500 Sec	0.0	
05-31	Time Duration Step 15	0.0 to 65500 Sec	0.0	
05-32	Time Unit Settings	00: 1 Sec 01: 0.1 Sec	00	

Group 6 Protection Function Parameters (Twice the value for 460V class)

Parameters	Functions	Settings	Factory Setting	Customer
06-00	Over-voltage Stall Prevention	230V: 330.0~410.0VDC 460V: 660.0~820.0VDC 00: Disable	390.0 780.0	
06-01	Over-current Stall Prevention during Acceleration	20~150% 00: Disable	120	
06-02	Over-current Stall Prevention during operation	20~150% 00: Disable	120	
06-03	Over-torque Detection Selection	00: Over-torque detection disabled. 01: Over-torque detection enabled during constant speed operation (OL2), and operation continues. 02: Over-torque detection enabled during constant speed operation (OL2), and operation halted. 03: Over-torque detection enabled during operation (OL2), and operation continues. 04: Over-torque detection enabled during operation (OL2), and operation halted.	00	
06-04	Over-torque Detection Level	30~150%	110	
06-05	Over-torque Detection Time	0.1~60.0 Sec	0.1	
06-06	Electronic Thermal Relay Selection	00: Operate disabled. 01: Operate with a standard motor. 02: Operate with a special motor.	02	
06-07	Electronic Thermal Characteristic	30~600 Sec	60	
06-08	Low Current Detection Level	00~100% (00 disabled)	00	
06-09	Low Current Detection Time	0.1~ 3600.0 Sec	10.0	
06-10	Low Current Detection Treatment	00: Warn and ramp to stop 01: Warn and coast to stop 02: Warn and keep operating	01	
06-11	Present Fault Record	00: No fault	00	
06-12	Second Most Recent Fault Record	01: Oc (over-current) 02: Ov (over-voltage)	00	
06-13	Third Most Recent Fault Record	03: OH (over temperature) 04: OL (over load)	00	

Parameters	Functions	Settings	Factory Setting	Customer
06-14	Fourth Recent Fault Record	05: oL1 (over load 1) 06: EF (External Fault) 07: Occ (IGBT module is abnormal) 08: cF3 (driver's internal circuitry is abnormal) 09: HPF (Hardware Protection Failure) 10: OcA (over-current during acceleration) 11: Ocd (over-current during deceleration) 12: Ocn (over-current during steady state operation) 13: GFF(Ground Fault) 14: Lv (Low voltage) 15: cF1 (EEPROM WRITE failure) 16: cF2 (EEPROM READ failure) 17: bb (Base block) 18: OL2 (over load2) 19: Reserved 20: Code (software/password protection) 21: EF1 (Emergency stop) 22: PHL (phase-loss) 23: Lc (Low Current) 24: FbL (Feedback Loss) 25: Reserved 26: FAnP (Fan Power Fault) 27: FF1 (Fan 1 fault) 28: FF2 (Fan 2 fault) 29: FF3 (Fan 3 fault) 30: FF123 (Fan 1, 2, 3 fault) 31: FF12 (Fan 1, 2 fault) 32: FF13 (Fan 1, 3 fault) 33: FF23 (Fan 2, 3 fault) 34: Fv (Gate Drive Low Voltage Protect)	00	
06-15	Parameter Reset	00~65535 09: Reset parameters (50Hz, 220/380) 10: Reset parameters (60Hz, 220/440)	00	
06-16	Parameter Protection Password Input	00~65535	00	
06-17	Parameter Protection Password Setting	00~65535 00: No password protection	00	

Group 7 AC Drive and Motor Parameters

Parameters	Functions	Settings	Factory Setting	Customer
07-00	Identity Code of AC Drive	Display by model type	##	
07-01	Rated Current of AC Drive	Display by model type	##	
✓ 07-02	Full-load Current of Motor	30~120%	100%	
✓ 07-03	No-load Current of Motor	1~99%	30%	
✓ 07-04	Auto Slip Compensation Gain	0.0~3.0	0.0	
07-05	Rated Slip Frequency of Motor	0.00~20.00Hz	0.00	
✓ 07-06	Auto Torque Compensation Gain	0.0~10.0	0.0	
✓ 07-07	Torque Compensation Gain by Manually	0.0~10.0	0.0	
07-08	Calculate Total Running Time of the Motor (Min)	00 to 1439 Min	00	
07-09	Calculate Total Running Time of the Motor (Day)	00 to 65535 Day	00	

Group 8 Special Parameters (Twice the value for 460V class)

Parameters	Functions	Settings	Factory Setting	Customer
08-00	DC Brake Current Level	00~100%	00	
08-01	DC Brake Time during Start-up	0.0~60.0 Sec	0.0	
08-02	DC Brake Time during Stopping	0.00~60.00 Sec	0.0	
08-03	Start-point for DC Brake	0.00~120.00 Hz	0.00	
08-04	Momentary Power Loss Operation Selection	00: Disable 01: Trace from top downward 02: Trace from bottom upward	00	
08-05	Maximum Allowable Power Loss Time	0.1~5.0 Sec	2.0	
08-06	Speed Search Time	0.1~5.0 Sec	0.5	
08-07	Maximum Speed Search Current	30~150%	110	
08-08	BB speed search method	00: Trace from top downward 01: Trace from bottom upward	00	
08-09	Auto Restart Times after Fault	00~10	00	
08-10	Auto Restart Time after Fault	00 to 60000 sec	600	
08-11	Operation Frequency Inhibition 1 UP	0.00~120.00 Hz	0.00	
08-12	Operation Frequency Inhibition 1 DOWN	0.00~120.00 Hz	0.00	
08-13	Operation Frequency Inhibition 2 UP	0.00~120.00 Hz	0.00	
08-14	Operation Frequency Inhibition 2 DOWN	0.00~120.00 Hz	0.00	
08-15	Operation Frequency Inhibition 3 UP	0.00~120.00 Hz	0.00	
08-16	Operation Frequency Inhibition 3 DOWN	0.00~120.00 Hz	0.00	
08-17	Automatic Energy-saving	00: Energy-saving operation disabled 01: Energy-saving operation enabled	00	
08-18	Automatic Voltage Regulation (AVR)	00: AVR function enabled 01: AVR function disabled 02: AVR function disabled for deceleration	00	
✎ 08-19	Software Setting of the Brake Level (the action level of the brake resistor)	230V: 370~410VDC 460V: 740~820VDC 00:Disable	380.0 760.0	
✎ 08-20	Vibration Compensation Factor	00~1000	00	

Group 9 Communication Parameters

Parameters	Functions	Settings	Factory Setting	Customer
✓ 09-00	Communication Address	01-254 00:Disable	01	
✓ 09-01	Transmission Speed (Baud Rate)	00: Baud rate 4800 01: Baud rate 9600 02: Baud rate 19200 03: Baud rate 38400	01	
✓ 09-02	Transmission Fault Treatment	00: Warn and keep operating 01: Warn and RAMP to stop 02: Warn and COAST to stop 03: No warning and no display	03	
09-03	Over Time Detection during Transmission	00: Disable 01: Enable	00	
09-04	Communication Format	00: 7-bit for ASCII 01: 8-bit for ASCII 02: 8-bit for RTU	00	
09-05	Even/Odd Parity and Stopping Parity Setting	00: None parity + 2 stop bit 01: Even parity + 2 stop bit 02: Odd parity + 2 stop bit 03: None parity + 1 stop bit 04: Even parity + 1 stop bit 05: Odd parity + 1 stop bit	00	
✓ 09-06	Communication Operation Command 1	Bit0~1: 00: Disable 01: Stop 10: Start-up 11: JOG start-up Bit2~3: Reserved Bit4~5: 00: No function 01: FWD command 10: REV command 11: Change direction command Bit6~7: 00: 1 st step accel/decel speed 01: 2 nd step accel/decel speed 10: 3 rd step accel/decel speed 11: 4 th step accel/decel speed	00	

	Parameters	Functions	Settings	Factory Setting	Customer
✓	09-06	Communication Operation Command 1	Bit8~11: 0000: Master speed 0001: 1 st step speed 0010: 2 nd step speed 0011: 3 rd step speed 0100: 4 th step speed 0101: 5 th step speed 0110: 6 th step speed 0111: 7 th step speed 1000: 8 th step speed 1001: 9 th step speed 1010: 10 th step speed 1011: 11 th step speed 1100: 12 th step speed 1101: 13 th step speed 1110: 14 th step speed 1111: 15 th step speed Bit12: Select Bit6~11 function Bit13~15 Reserved	00	
✓	09-07	Communication Frequency Setting	0~120.00Hz	60.00	
✓	09-08	Communication Operation Command 2	Bit0: 1: EF ON Bit1: 1: Reset Bit2: 0: BB OFF, 1: BB ON Bit3~15: Reserved	00	

Group 10 PID Controls

Parameters	Functions	Settings	Factory Setting	Customer	
10-00	Input Terminal for PID Feedback	00: No function 01: Input via AVI 02: Input via AC11 03: Input via AC12 04: Input via External Reference	00		
10-01	PID Control Detection Signal Reference	0.0-6550.0	1000.0		
10-02	PID Feedback Control Method	00: Negative feedback control 01: Positive feedback control	00		
10-03	Proportional Gain (P)	0.0~10.0	1.0		
10-04	Integral Time (I)	0.00~100.00 Sec	1.00		
10-05	Differential Time (D)	0.00~1.00 Sec	0.00		
10-06	Upper Bound for Integral Control	00~200%	100		
10-07	Primary Low Pass Filter Time	0.0~2.5 Sec	0.0		
10-08	PID Feedback Signal Range	0.0~6550.0	600.0		
10-09	PID Feedback Signal Fault Treatment Time	0. 0~3600.0 Sec 0.0: Disable	0.0		
✓	10-10	PID Feedback Signal Fault Treatment	00: Warn and RAMP stop 01: Warn and COAST stop 02: Warn and keep operating	01	
✓	10-11	PID Minimum Output Frequency	0: By PID controller 1: By AC drive	01	

Group 11 Fan and Pump Control Parameters

Parameters	Functions	Settings	Factory Setting	Customer
11-00	V/F Curve Selection	00: Determined by group 01 01: 1.5 power curve 02: 1.7 power curve 03: 2 power curve 04: 3 power curve	00	
11-01	Circulative Control	00: No function 01: Time circulation (by time) 02: Fixed amount circulation (by PID) 03: Fixed amount control (an AC drive runs with 4 motors)	00	
11-02	Multiple Motors Control	01~04	01	
11-03	Time Circulation Time Setting	00~65500 Min	00	
11-04	Motor Switch Delay Time	0.0~3600.0 sec	1.0	
11-05	Motor Switch Delay Time during Fixed Amount Circulation	0.0~3600.0 sec	10.0	
11-06	Motor Switch Frequency during Fixed Amount Circulation	0.00 to 120.00 Hz	60.00	
11-07	Enter Sleep Process Time	0.0~3600.0sec 0.0: Sleep function disable	0.0	
11-08	Sleep Frequency of Sleep Process	0.00 to 11-09 (Wake up Frequency)	0.0	
11-09	Wake Up Frequency of Sleep Process	0.00 to 120.0Hz	0.0	
11-10	Treatment of Fixed Amount Circulation Malfunction	00: Turn off all motors 01: Turn off AC drive	00	
11-11	Stop Frequency of Auxiliary Motor	0.00~120.00Hz	0.00	



This page intentionally left blank.

Specifications

Voltage Class		230V Class											
Model Number VFD-__F23_		007	015	022	037	055	075	110	150	185	220	300	370
Max. Applicable Motor Output (kW)		0.75	1.5	2.2	3.7	5.5	7.5	11	15	18.5	22	30	37
Max. Applicable Motor Output (HP)		1.0	2.0	3.0	5.0	7.5	10	15	20	25	30	40	50
Output Rating	Rated Output Capacity (KVA)	1.9	2.5	4.2	6.5	9.5	12.5	18.3	24.7	28.6	34.3	45.7	55
	Rated Output Current (A)	5.0	7.0	11	17	25	33	49	65	75	90	120	145
	Maximum Output Voltage (V)	Proportional to Input Voltage											
	Rated Frequency (Hz)	0.10-120.00Hz											
Input Rating	Carrier Frequency (kHz)	4-10						3-9			2-6		
	Rated Input Current (A)	5.7	7.6	15.5	20.6	26	34	50	60	75	90	110	142
	Rated Voltage	3-phase 180-264 V											
	Frequency Tolerance	47 – 63 Hz											

Voltage Class		460V Class																				
Model Number VFD-__F43_		007	015	022	037	055	075	110	150	185	220	300	370	450	550	750	900	1100	1320	1600	1850	2200
Max. Applicable Motor Output (kW)		0.75	1.5	2.2	3.7	5.5	7.5	11	15	18.5	22	30	37	45	55	75	90	110	132	160	185	220
Max. Applicable Motor Output (HP)		1.0	2.0	3.0	5.0	7.5	10	15	20	25	30	40	50	60	75	100	125	150	175	215	250	300
Output Rating	Rated Output Capacity (KVA)	2.3	3.2	4.2	6.5	10	14	18	25	29	34	46	56	69	84	114	137	168	198	236	281	350
	Rated Output Current (A)	2.7	4.2	5.5	8.5	13	18	24	32	38	45	60	73	91	110	150	180	220	260	310	370	460
	Maximum Output Voltage (V)	Proportional to Input Voltage																				
	Rated Frequency (Hz)	0.10-120.00Hz																				
Input Rating	Carrier Frequency (kHz)	4-10						3-9			2-6											
	Rated Input Current (A)	3.2	4.3	5.9	11.2	14	19	25	32	39	49	60	73	91	120	160	160	200	240	300	380	400
	Rated Voltage	3-phase 342-528 V																				
	Frequency Tolerance	47 – 63 Hz																				

General Specifications

Control Characteristics	Control System	SPWM (Sinusoidal Pulse Width Modulation, carrier frequency 2-10kHz)		
	Output Frequency Resolution	0.01Hz		
	Torque Characteristics	Including the auto-torque, auto-slip compensation; starting torque can be 150% at 1.0Hz		
	Overload Endurance	120% of rated current for 1 minute		
	Accel/Decel Time	1-36000/0.1-3600.0/0.01-360.00 seconds (3 Independent settings for Accel/Decel Time)		
	V/f Pattern	Adjustable V/f pattern		
Operating Characteristics	Stall Prevention Level	20 to 150%, Setting of Rated Current		
	Frequency Setting	Keypad	Setting by  	
		External Signal	1 set of AVI analog voltage DC0-+10V/0-+5V, 2 sets of ACI analog current 0/4-20mA, 15 Multi-Function Inputs, RS-485 interface (MODBUS), External terminals UP/DOWN Key	
	Operation Setting Signal	Keypad	Set by RUN, STOP and JOG	
		External Signal	Operation by FWD, REV, JOG and communication operation	
	Multi-Function Input Signal	Multi-step selection 0 to 15, Jog, accel/decel inhibit, first to forth accel/decel switches, counter, external Base Block (NC, NO), JOG, auxiliary motor start/maintenance		
	Multi-Function Output Indication	AC Drive Operating, Frequency Attained, Desired Frequency Attained, Zero speed, Base Block, Fault Indication, Local/Remote indication, and Auxiliary Motor Output		
Analog Output Signal	2 sets of Analog frequency/current signal output			

Other Functions		AVR, 2 kinds of S-Curve, Over-Voltage, Over-Current Stall Prevention, Fault Records, Reverse inhibition, DC Brake, Momentary Power Loss restart, Auto torque and slip compensation, PID Control, Parameter Lock/Reset, Frequency Limits, Adjustable Carrier Frequency, 4 sets of Fan & Pump Control,
Protection		Self-testing, Over Voltage, Over Current, Under Voltage, Overload, Overheating, External Fault, Electronic thermal, Ground Fault, Phase-loss
Built-in Reactor		DC Reactor: 25~215HP AC Reactor: 250~300HP
Built-in Brake Chopper		1~20HP
Cooling Methods		Forced Fan-cooled
Environment	Installation Location	Altitude 1,000 m or lower, keep from corrosive gasses, liquid and dust
	Pollution Degree	2
	Ambient Temperature	-10°C to 40°C Non-Condensing and not frozen
	Storage/ Transportation Temperature	-20°C to 60°C
	Ambient Humidity	Below 90% RH (non-condensing)
	Vibration	9.80665m/s ² (1G) less than 20Hz, 5.88m/s ² (0.6G) at 20 to 50Hz

ACCESSORIES

B.1 All Brake Resistors & Brake Units Used in AC Motor Drives

Note: Please only use DELTA resistors and recommended values. Other resistors and values will void Delta's warranty. Please contact your nearest Delta representative for use of special resistors. For instance, in 460 V series, 100 HP, AC drive has 2 brake units with total of 16 brake resistors, so each brake unit uses 8 brake resistors. There should be at least 10 cm away from AC drive to avoid possible noise. Refer to the "Brake Unit Module User Manual" for further detail.

Voltage	Applicable Motor		★ Full Load Torque KG-M	Equivalent Resistors Specification for Each AC Drive	Brake Unit Model VFDB No. of Unit Used		Brake Resistors Model No. of Units Used	Brake Torque 10%ED%	Equivalent Minimum Resistor Value for Each AC Drive		
	HP	KW									
230V series	1	0.75	0.427	80W 200Ω			BR080W200	1	125	80Ω	
	2	1.5	0.849	300W 100Ω			BR300W100	1	125	55Ω	
	3	2.2	1.262	300W 70Ω			BR300W070	1	125	35Ω	
	5	3.7	2.080	400W 40Ω			BR400W040	1	125	25Ω	
	7.5	5.5	3.111	500W 30Ω			BR500W030	1	125	16Ω	
	10	7.5	4.148	1000W 20Ω			BR1K0W020	1	125	12Ω	
	15	11	6.186	2400W 13.6Ω			BR1K2W6P8	2	125	13.6Ω	
	20	15	8.248	3000W 10Ω	2015	1	BR1K5W005	2	125	10Ω	
	25	18.5	10.281	4800W 8Ω	2022	1	BR1K2W008	4	125	8Ω	
	30	22	12.338	4800W 6.8Ω	2022	1	BR1K2W6P8	4	125	6.8Ω	
	40	30	16.497	6000W 5Ω	2015	2	BR1K5W005	4	125	5Ω	
	50	37	20.6	9600W 4Ω	2015	2	BR1K2W008	8	125	4Ω	
	460V Series	1	0.75	0.427	80W 750Ω			BR080W750	1	125	160Ω
		2	1.5	0.849	300W 400Ω			BR300W400	1	125	160Ω
		3	2.2	1.262	300W 250Ω			BR300W250	1	125	160Ω
5		3.7	2.080	400W 150Ω			BR400W150	1	125	130Ω	
7.5		5.5	3.111	500W 100Ω			BR500W100	1	125	60Ω	
10		7.5	4.148	1000W 75Ω			BR1K0W075	1	125	45Ω	
15		11	6.186	1000W 50Ω			BR1K0W050	1	125	50Ω	
20		15	8.248	1500W 40Ω			BR1K5W040	1	125	40Ω	
25		18.5	10.281	4800W 32Ω	4030	1	BR1K2W008	4	125	32Ω	
30		22	12.338	4800W 27.2Ω	4030	1	BR1K2W6P8	4	125	27.2Ω	
40		30	16.497	6000W 20Ω	4030	1	BR1K5W005	4	125	20Ω	
50		37	20.6	9600W 16Ω	4045	1	BR1K2W008	8	125	16Ω	
60		45	24.745	9600W 13.6Ω	4045	1	BR1K2W6P8	8	125	13.6Ω	
75		55	31.11	12000W 10Ω	4030	2	BR1K5W005	8	125	10Ω	
100		75	42.7	19200W 6.8Ω	4045	2	BR1K2W6P8	16	125	6.8Ω	
120		90	52.5	13500W 5Ω	4132	1	BR1K5W005	9	120	5Ω	
150		110	61	21600W 4Ω	4132	1	BR1K2W008	18	120	4Ω	
175		132	73.5	21600W 4Ω	4132	1	BR1K2W008	18	100	4Ω	
215	160	89	21600W 3.4Ω	4132	1	BR1K2W6P8	18	97	3.4Ω		
250	185	103	27000W 2.5Ω	4132	2	BR1K5W005	18	115	2.5Ω		
300	220	122.5	27000W 2.5Ω	4132	2	BR1K5W005	18	96	2.5Ω		

★: Standard 4-pole motor

1. Please select the brake unit and/or brake resistor according to the table. "-" means no Delta product. Please use the brake unit according to the Equivalent Resistor Value.
2. If damage to the drive or other equipment is due to the fact that the brake resistors and the brake modules in use are not provided by Delta, the warranty will be void.
3. Take into consideration the safety of the environment when installing the brake resistors.
4. If the minimum resistance value is to be utilized, consult local dealers for the calculation of the power in Watt.
5. Please select thermal relay trip contact to prevent resistor over load. Use the contact to switch power off to the AC motor drive!
6. When using more than 2 brake units, equivalent resistor value of parallel brake unit can't be less than the value in the column "Minimum Equivalent Resistor Value for Each AC Drive" (the right-most column in the table).
7. Please read the wiring information in the user manual of the brake unit thoroughly prior to installation and operation.
8. In applications with brake resistor or brake unit, Pr.06-00 (Over-voltage stall prevention) must be disabled. And Pr.08-18 (AVR function) shall not be used.

9. Definition for Brake Usage ED%

Explanation: The definition of the brake usage ED(%) is for assurance of enough time for the brake unit and brake resistor to dissipate away heat generated by braking. When the brake resistor heats up, the resistance would increase with temperature, and brake torque would decrease accordingly. Suggest cycle time is one minute.

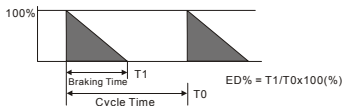

10. For safety reasons, install a thermal overload relay between brake unit and brake resistor. Together with the magnetic contactor (MC) in the mains supply circuit to the drive it offers protection in case of any malfunctioning. The purpose of installing the thermal overload relay is to protect the brake resistor against damage due to frequent braking or in case the brake unit is continuously on due to unusual high input voltage. Under these circumstances the thermal overload relay switches off the power to the drive. Never let the thermal overload relay switch off only the brake resistor as this will cause serious damage to the AC Motor Drive.

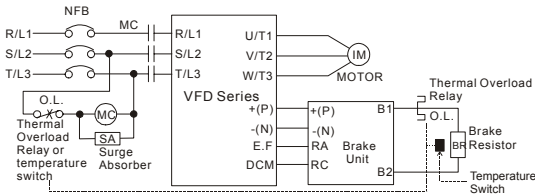

Note1: When using the AC drive with DC reactor, please refer to wiring diagram in the AC drive user manual for the wiring of terminal + (P) of brake unit.

Note2: **Do NOT** wire terminal - (N) to the neutral point of power system.

B.1.1 Dimensions and Weights for Brake Resistors

(Dimensions are in millimeter)

Order P/N: BR080W200, BR080W750, BR300W070, BR300W100, BR300W250,
BR300W400, BR400W150, BR400W040

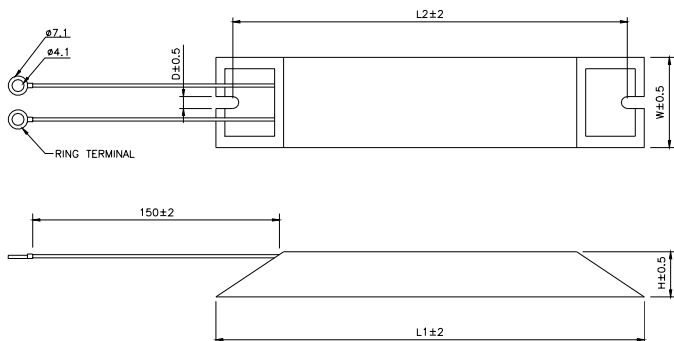

TYPE	L1	L2	H	D	W	MAX. WEIGHT(g)
BR080W200	140	125	20	5.3	60	160
BR080W750	140	125	20	5.3	60	160
BR300W070	215	200	30	5.3	60	750
BR300W100	215	200	30	5.3	60	750
BR300W250	215	200	30	5.3	60	750
BR300W400	215	200	30	5.3	60	750
BR400W150	265	250	30	5.3	60	930
BR400W040	265	250	30	5.3	60	930

Order P/N: BR500W030, BR500W100, BR1K0W020, BR1K0W075

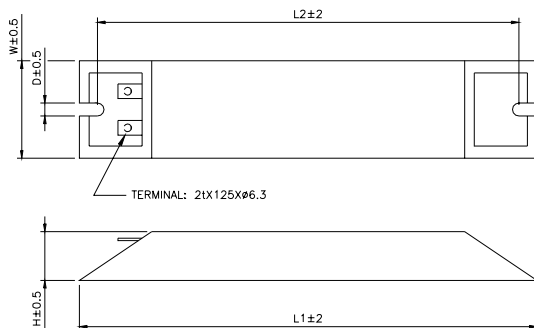

TYPE	L1	L2	H	D	W	MAX. WEIGHT(g)
BR500W030	335	320	30	5.3	60	1100
BR500W100	335	320	30	5.3	60	1100
BR1K0W020	400	385	50	5.3	100	2800
BR1K0W075	400	385	50	5.3	100	2800

Order P/N: BR1K0W050, BR1K2W008, BR1K2W6P8, BR1K5W005, BR1K5W040

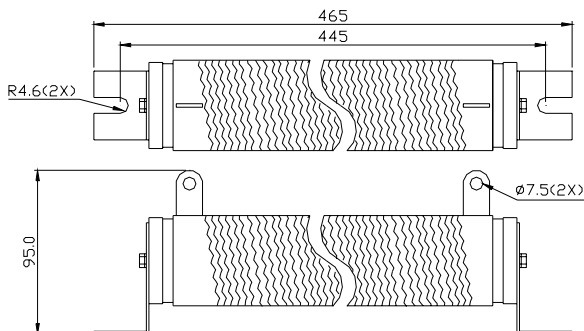

B.1.2 Specifications for Brake Unit

Voltage Class		230V Series		460V Series		
Model Number VFDB-□□□□		2015	2022	4030	4045	4132
Max. Motor Power (kW)		15	22	30	45	132
Output Rating	Max. Peak Discharge Current (A) 10%ED	40	60	40	60	240
	Continuous Discharge Current (A)	15	20	15	18	75
	Brake Start-up Voltage (DC)	330/345/360/380/400/415 ±3V		660/690/720/760/800/830 ±6V		618/642/667/690/725/750±6V
Input Rating	DC Voltage	200~400VDC		400~800VDC		480~750VDC
Protection	Heat Sink Overheat	Temperature over +95°C (203 °F)				
	Alarm Output	RELAY contact 5A120Vac/28Vdc(RA, RB, RC)				
	Power Charge Display	Blackout until bus (+~) voltage is below 50VDC				
Environment	Installation Location	Indoor (no corrosive gases, metallic dust)				
	Operating Temperature	-10°C ~ +50°C				
	Storage Temperature	-20°C ~ +60°C				
	Humidity	90% Non-condensing				
	Vibration	9.8m/S ² (1G) under 20Hz 2m/S ² (0.2G) at 20~50Hz				
Wall-mounted Enclosed Type		IP50			IP10	

B.1.3 Dimensions for Brake Unit

(Dimensions are in millimeter[inch])

Figure 1: VFDB2015, VFDB2022, VFDB4030, VFDB4045

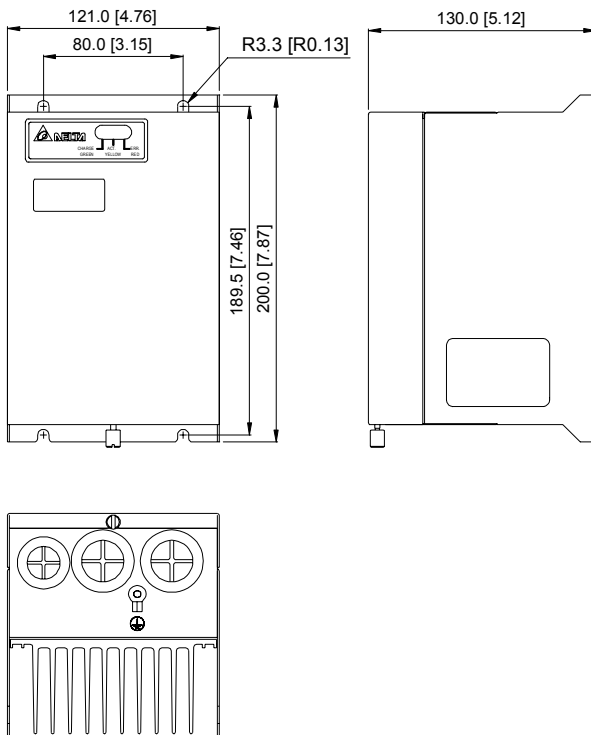
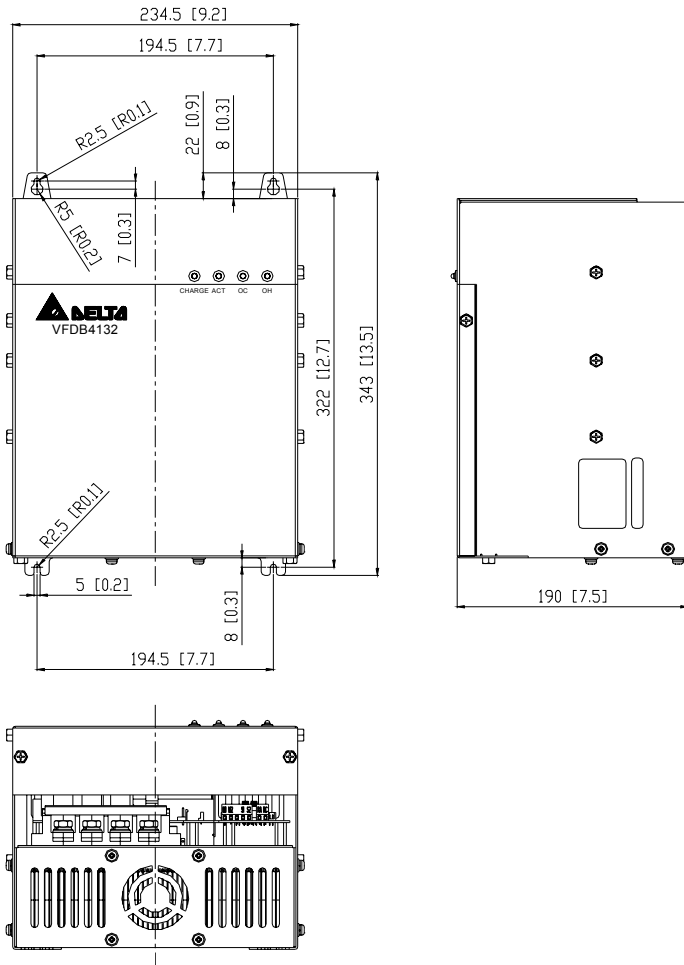

Figure 2: VFDB4132



B

B.2 AMD-EMI Filter Cross Reference

AC Drives	EMI Model Number
VFD007F23A/H, VFD015F23A/H, VFD022F23A/H, VFD037F23A/H	26TDT1W4C
VFD110F23A/H, VFD055F23A/H, VFD075F23A/H, VFD185F43A/H	50TDS4W4C
VFD150F23A/H, VFD220F43A/H, VFD300F43A/H, VFD370F43A/H	100TDS84C
VFD220F23A/H, VFD185F23A/H, VFD300F23A/H, VFD450F43A/H	150TDS84C
VFD370F23A/H, VFD550F43A/H	180TDS84C
VFD750F43A/H	200TDDS84C

Installation

All electrical equipment, including AC motor drives, will generate high-frequency/low-frequency noise and will interfere with peripheral equipment by radiation or conduction when in operation. By using an EMI filter with correct installation, much interference can be eliminated. It is recommended to use DELTA EMI filter to have the best interference elimination performance.

We assure that it can comply with following rules when AC motor drive and EMI filter are installed and wired according to user manual:

- EN61000-6-4
- EN61800-3: 1996 + A11: 2000
- EN55011 (1991) Class A Group 1 (1st Environment, restricted distribution)

General precaution

1. EMI filter and AC motor drive should be installed on the same metal plate.
2. Please install AC motor drive on footprint EMI filter or install EMI filter as close as possible to the AC motor drive.
3. Please wire as short as possible.
4. Metal plate should be grounded.
5. The cover of EMI filter and AC motor drive or grounding should be fixed on the metal plate and the contact area should be as large as possible.

Choose suitable motor cable and precautions

Improper installation and choice of motor cable will affect the performance of EMI filter. Be sure to observe the following precautions when selecting motor cable.

1. Use the cable with shielding (double shielding is the best).
2. The shielding on both ends of the motor cable should be grounded with the minimum length and maximum contact area.
3. Remove any paint on metal saddle for good ground contact with the plate and shielding.

Remove any paint on metal saddle for good ground contact with the plate and shielding.

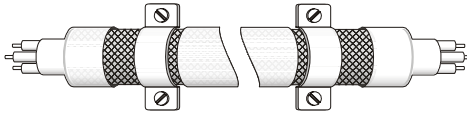
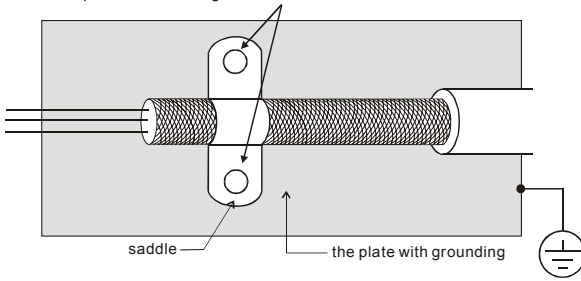

Saddle on both ends

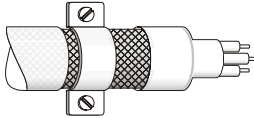

Saddle on one end

B.3 AC Reactor

AC Input Reactor Recommended Value

460V, 50/60Hz, 3-Phase

KW	HP	Fundamental Amps	Max. Continuous Amps	Inductance (mh)	
				3% impedance	5% impedance
0.75	1	4	6	9	12
1.5	2	4	6	6.5	9
2.2	3	8	12	5	7.5
3.7	5	8	12	3	5
5.5	7.5	12	18	2.5	4.2
7.5	10	18	27	1.5	2.5
11	15	25	37.5	1.2	2
15	20	35	52.5	0.8	1.2
18.5	25	35	52.5	0.8	1.2
22	30	45	67.5	0.7	1.2
30	40	55	82.5	0.5	0.85
37	50	80	120	0.4	0.7
45	60	80	120	0.4	0.7
55	75	100	150	0.3	0.45
75	100	130	195	0.2	0.3
90	125	160	240	0.15	0.23
110	150	200	300	0.11	0.185
132	175	250	375	0.09	0.15
160	215	320	480	0.075	0.125
185	250	400	560	0.06	0.105
220	300	500	700	0.05	0.085

460V DC Choke

Input Voltage	kW	HP	DC Amps	Inductance (mh)
	0.75	1	4	25.00
	1.5	2	9	11.50
	2.2	3	9	11.50
	3.7	5	12	6.00
	5.5	7.5	18	3.75
	7.5	10	25	4.00
	11	15	32	2.68
	15	20	50	2.00

NOTE

18.5kW~132kW models: built-in DC choke

160kW~220kW models: built-in AC reactor

AC Output Reactor Recommended Value

230V, 50/60Hz, 3-Phase

kW	HP	Fundamental Amps	Max. continuous Amps	Inductance (mH)	
				3% impedance	5% impedance
0.75	1	8	12	3	5
1.5	2	8	12	1.5	3
2.2	3	12	18	1.25	2.5
3.7	5	18	27	0.8	1.5
5.5	7.5	25	37.5	0.5	1.2
7.5	10	35	52.5	0.4	0.8
11	15	55	82.5	0.25	0.5
15	20	80	120	0.2	0.4
18.5	25	80	120	0.2	0.4
22	30	100	150	0.15	0.3
30	40	130	195	0.1	0.2
37	50	160	240	0.075	0.15

460V, 50/60Hz, 3-Phase

kW	HP	Fundamental Amps	Max. continuous Amps	Inductance (mH)	
				3% impedance	5% impedance
0.75	1	4	6	9	12
1.5	2	4	6	6.5	9
2.2	3	8	12	5	7.5
3.7	5	12	18	2.5	4.2
5.5	7.5	18	27	1.5	2.5
7.5	10	18	27	1.5	2.5
11	15	25	37.5	1.2	2
15	20	35	52.5	0.8	1.2
18.5	25	45	67.5	0.7	1.2
22	30	45	67.5	0.7	1.2
30	40	80	120	0.4	0.7
37	50	80	120	0.4	0.7
45	60	100	150	0.3	0.45
55	75	130	195	0.2	0.3
75	100	160	240	0.15	0.23
90	125	160	240	0.15	0.23
110	150	200	300	0.11	0.185
185	250	320	480	0.075	0.125
220	300	400	600	0.06	0.105

B.4 Non-fuse Circuit Breaker Chart

The fuse should comply with UL248 and the breaker should comply with UL489.

The current rating of the breaker shall be within 2~4 times maximum input current rating.

Model	3-phase
	Recommended non-fuse breaker (A)
VFD007F23A	10
VFD007F43A/H	5
VFD015F23A	15
VFD015F43A/H	10
VFD022F23A	30
VFD022F43A/H	15
VFD037F23A	40
VFD037F43A/H	20
VFD055F23A	50
VFD055F43B/H	30
VFD075F23A	60
VFD075F43B/H	40
VFD110F23A	100
VFD110F43A/H	50
VFD150F23A	125
VFD150F43A/H	60
VFD185F23A	150
VFD185F43A/H	75
VFD220F23A	175
VFD220F43A/H	100
VFD300F23A	225
VFD300F43A/H	125
VFD370F23A	250
VFD370F43A/H	150
VFD450F43A/H	175
VFD550F43A/H	250
VFD750F43A/H	300
VFD900F43C/H	300
VFD1100F43C/H	400
VFD1320F43A/H	500
VFD1600F43A/H	600
VFD1850F43A/H	600
VFD2200F43A/H	800

B.5 Fuse Specification Chart

Smaller fuses than those shown in the table are permitted.

Model	I (A) Input	I (A) Output	Line Fuse	
			I (A)	Bussmann P/N
VFD007F23A	5.7	5.0	10	JJN-10
VFD007F43A/H	3.2	2.7	5	JJS-6
VFD015F23A	7.6	7.0	15	JJN-15
VFD015F43A/H	4.3	4.2	10	JJS-10
VFD022F23A	15.5	11	30	JJN-30
VFD022F43A/H	5.9	5.5	15	JJS-15
VFD037F23A	20.6	17	40	JJN-40
VFD037F43A/H	11.2	8.5	20	JJS-20
VFD055F23A	26	25	50	JJN-50
VFD055F43B/H	14	13	30	JJS-30
VFD075F23A	34	33	60	JJN-60
VFD075F43B/H	19	18	40	JJS-40
VFD110F23A	50	49	100	JJN-100
VFD110F43A/H	25	24	50	JJS-50
VFD150F23A	60	65	125	JJN-125
VFD150F43A/H	32	32	60	JJS-60
VFD185F23A	75	75	150	JJN-150
VFD185F43A/H	39	38	75	JJS-70
VFD220F23A	90	90	175	JJN-175
VFD220F43A/H	49	45	100	JJS-100
VFD300F23A	110	120	225	JJN-225
VFD300F43A/H	60	60	125	JJS-125
VFD370F23A	142	145	250	JJN-250
VFD370F43A/H	63	73	150	JJS-150
VFD450F43A/H	90	91	175	JJS-175
VFD550F43A/H	130	110	250	JJS-250
VFD750F43A/H	160	150	300	JJS-300
VFD900F43C/H	160	180	300	JJS-300
VFD1100F43C/H	200	220	400	JJS-400
VFD1320F43A/H	240	260	500	JJS-500
VFD1600F43A/H	300	310	600	JJS-600
VFD1850F43A/H	380	370	600	JJS-600
VFD2200F43A/H	400	460	800	JJS-800

B.6 PU06

B.6.1 Description of the Digital Keypad VFD-PU06

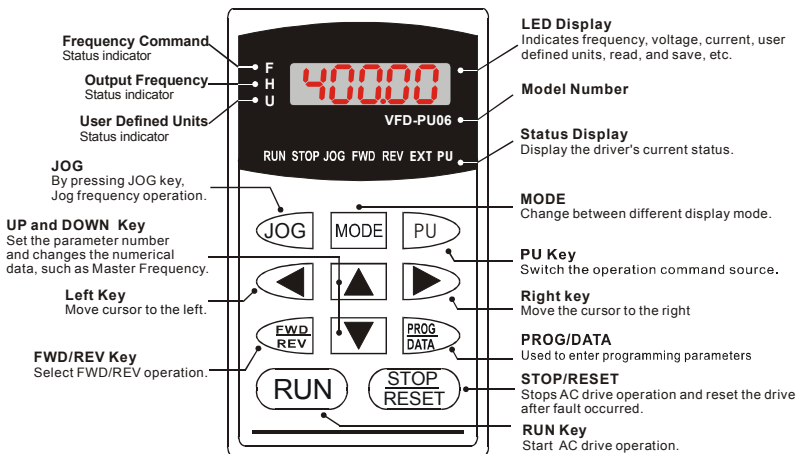

B.6.2 Explanation of Display Message

Display Message	Descriptions
	The AC motor drive Master Frequency Command.
	The Actual Operation Frequency present at terminals U, V, and W.
	The custom unit (u)
	The output current present at terminals U, V, and W.
	Press to change the mode to READ. Press PROG/DATA for about 2 sec or until it's flashing, read the parameters of AC drive to the digital keypad PU06. It can read 4 groups of parameters to PU06. (read 0 – read 3)
	Press to change the mode to SAVE. Press PROG/DATA for about 2 sec or until it's flashing, then write the parameters from the digital keypad PU06 to AC drive. If it has saved, it will show the type of AC motor drive.

Display Message	Descriptions
	The specified parameter setting.
	The actual value stored in the specified parameter.
	External Fault
	"End" displays for approximately 1 second if the entered input data have been accepted. After a parameter value has been set, the new value is automatically stored in memory. To modify an entry, use the or keys.
	"Err" displays if the input is invalid.
	Communication Error. Please check the AC motor drive user manual (Chapter 5, Group 9 Communication Parameter) for more details.

B.6.3 PU06 Operation Flow Chart

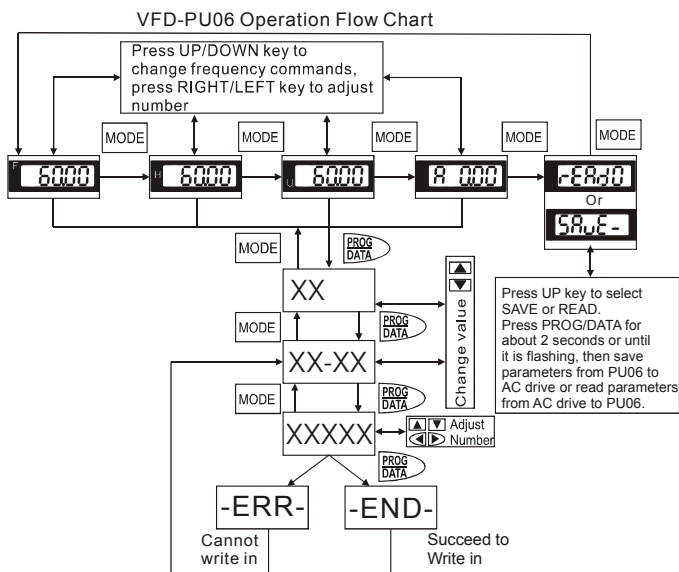

B

B.7 Relay Card

Specifications:

1. Screw Length (between RELAY CARD and Control Board): 8mm or less.
2. Torque Rating: 3~4 kgf-cm or less.
3. Wire Gauge: 16~26 AWG.
4. Maximum Voltage/Current of each contact: Max. 250VAC/2A
5. Maximum Momentary Voltage/Current of each contact:
Max. 350VAC/8A, transient time is 10m sec
6. Close/Restoring Time of each contact: Typical 5/1 ms
7. Ambient Temperature: -10⁰C to 40⁰C (non-condensing and not frozen)
8. Ambient Humidity: less than 90%RH (not frozen)
9. Environment:
 - Installation Altitude: below 1000m
 - Always use this product in a clean indoor location free from dust, corrosive gases and liquid.
10. Vibration:
 - Maximum 9.80665 m/s² (1G) at less than 20 Hz
 - Maximum 5.88 m/s² (0.6G) at 20Hz to 50Hz

Notes:

1. Please put RC network or Varistor on the side of coil to prevent sparks when connect the inductance loading device, i.e. relay, magnetic contactor, motor...etc.
2. It is recommended to put the fuses into the circuit if having safety concern when using this product. (The specification of used fuses must be within the limit of contact.)
3. Please use the isolated wires as much as possible to avoid interferences. (The isolated layer must be grounded to the earth.)
4. The ends of wires must be plated with tin or connected with terminals.
5. For the safety concern, route the Relay Card wires separately and far away from other control wires, motor wires and power wires...etc. at least 15cm. Where these wires must cross to each other please make sure they are at a 90 degree angle.
6. Always use and operate this product within the limit of its specifications.
7. For other operation notes, please refer to the user's manuals of AC motor drive.

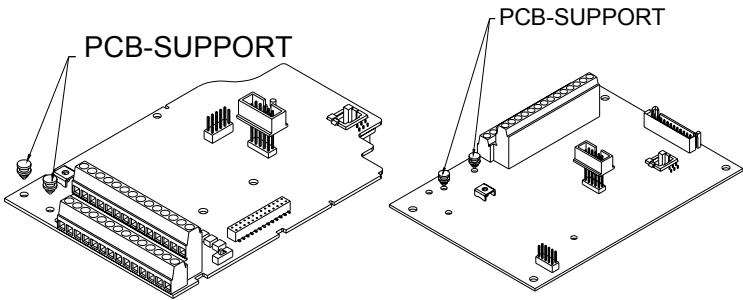

SCREW M3*P0.5
 TORQUE=2~4Kgf-cm
 INSULATOR
 RELAY-CARD

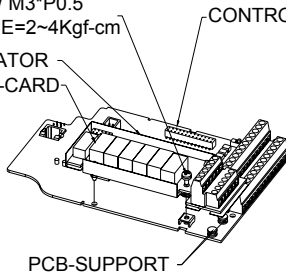

SCREW M3*P0.5
 TORQUE=2~4Kgf-cm
 INSULATOR
 RELAY-CARD

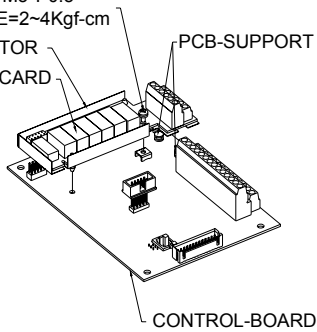

B

B.8 Zero Phase Reactor (RF220X00A)

Dimensions are in millimeter and (inch)

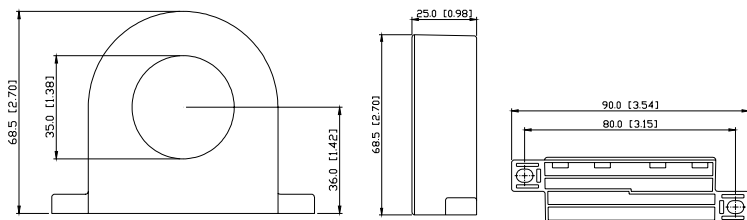

Cable type (Note)	Recommended Wire Size (mm ²)			Qty.	Wiring Method
	AWG	mm ²	Nominal (mm ²)		
Single-core	≤ 10	≤ 5.3	≤ 5.5	1	Diagram A
	≤ 2	≤ 33.6	≤ 38	4	Diagram B
Three-core	≤ 12	≤ 3.3	≤ 3.5	1	Diagram A
	≤ 1	≤ 42.4	≤ 50	4	Diagram B

Note: 600V Insulated unshielded Cable.

Diagram A

Please wind each wire 4 times around the core. The reactor must be put at inverter output as close as possible.

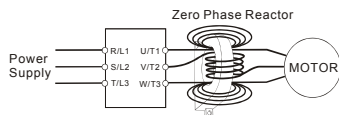
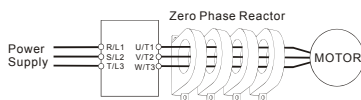

Diagram B

Please put all wires through 4 cores in series without winding.



Note 1: The table above gives approximate wire size for the zero phase reactors, but the selection is ultimately governed by the type and diameter of cable fitted, i.e. the cable must fit through the center hole of zero phase reactors.

Note 2: Only the phase conductors should pass through, not the earth core or screen.

Note 3: When long motor output cables are used, an output zero phase reactor may be required to reduce radiated emissions from the cable.

DIMENSIONS

Frame B

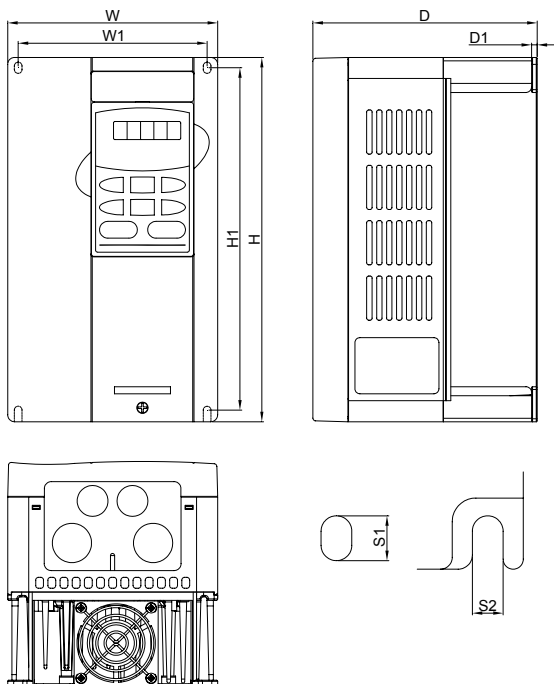

UNIT: mm [inch]

Frame	W	W1	H	H1	D	D1	S1	S2
B1	150.0 [5.91]	135.0 [5.32]	260.0 [10.24]	244.3 [9.63]	160.2 [6.31]	4.0 [0.16]	8.0 [0.32]	6.5 [0.26]

NOTE

Frame B(B1): VFD007F23A; VFD007F43A; VFD007F43H; VFD015F23A; VFD015F43A; VFD015F43H; VFD022F23A;
VFD022F43A; VFD022F43H; VFD037F23A; VFD037F43A; VFD037F43H

Frame C

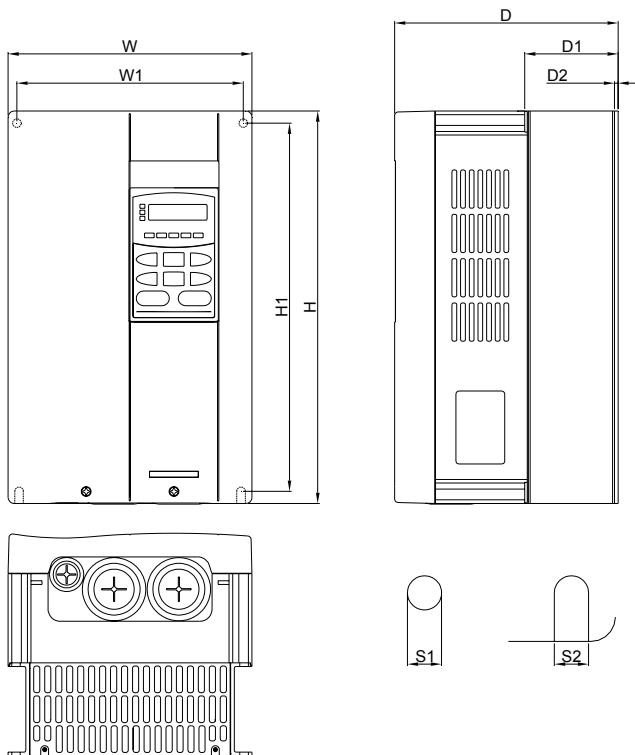

UNIT: mm [inch]

Frame	W	W1	H	H1	D	D1	D2	S1	S2
C1	200.0 [7.88]	185.6 [7.31]	323.0 [12.72]	303.0 [11.96]	183.2 [7.22]	76.5 [3.01]	3.0 [0.12]	7.0 [0.28]	7.0 [0.28]

NOTE

Frame C(C1): VFD055F23A; VFD055F43B; VFD055F43H; VFD075F23A; VFD075F43B; VFD075F43H; VFD110F23A;
VFD110F43A; VFD110F43H; VFD150F43A; VFD150F43H

Frame D

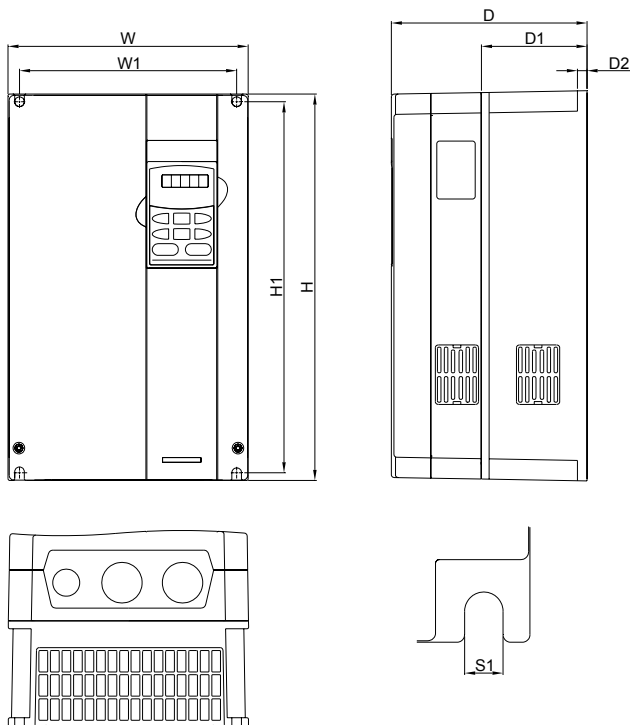

UNIT: mm [inch]

Frame	W	W1	H	H1	D	D1	D2	S1
D1	250.0 [9.84]	226.0 [8.90]	403.8 [15.90]	384.0 [15.12]	205.4 [8.08]	110.0 [4.33]	8.0 [0.31]	10.0 [0.39]

NOTE

Frame D(D1): VFD150F23A; VFD185F23A; VFD185F43A; VFD185F43H; VFD220F23A; VFD220F43A; VFD220F43H;
VFD300F43A; VFD300F43H

C

Frame E

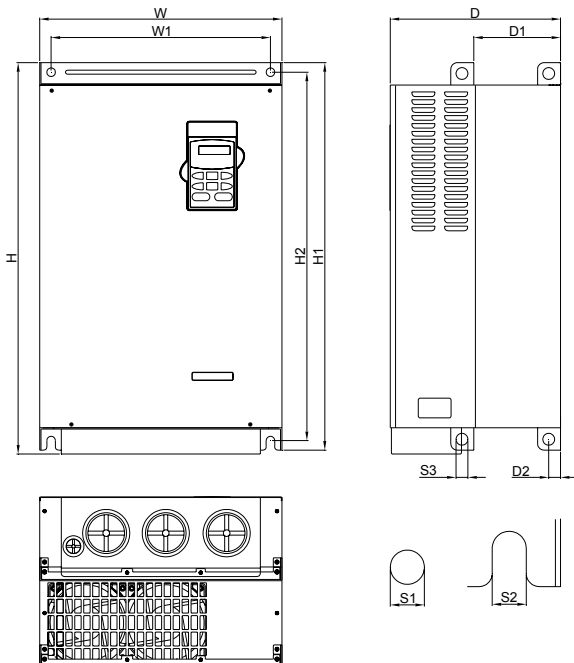

UNIT: mm [inch]

Frame	W	W1	H	H1	H2	D	D1	D2	S1	S2	S3
E1	370.0 [14.57]	335.0 [13.19]	-	589.0 [23.19]	560.0 [22.05]	260.0 [10.24]	132.5 [5.22]	18.0 [0.71]	13.0 [0.51]	13.0 [0.51]	18.0 [0.71]
E2	370.0 [14.57]	335.0 [13.19]	595.0 [23.43]	589.0 [23.19]	560.0 [22.05]	260.0 [10.24]	132.5 [5.22]	18.0 [0.71]	13.0 [0.51]	13.0 [0.51]	18.0 [0.71]

NOTE

Frame E(E1): VFD300F23A; VFD370F23A; VFD750F43A; VFD750F43H; VFD900F43C; VFD900F43H

Frame E(E2): VFD370F43A; VFD370F43H; VFD450F43A; VFD450F43H; VFD550F43A; VFD550F43H

Frame G

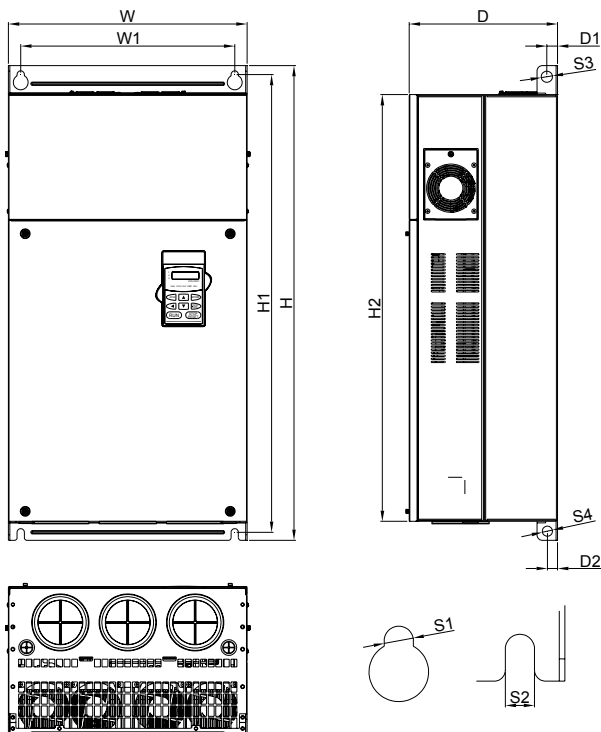

UNIT: mm [inch]

Frame	W	W1	H	H1	H2	D	D1	D2	S1	S2	S3	S4
G1	425.0 [16.73]	381.0 [15.00]	850.0 [33.46]	819.5 [32.26]	746.0 [30.08]	264.0 [10.39]	19.0 [0.75]	18.0 [0.71]	13.0 [0.51]	13.0 [0.51]	20.00 [0.79]	18.0 [0.71]

NOTE

Frame G(G1): VFD1100F43C; VFD1100F43H; VFD1320F43A; VFD1320F43H; VFD1600F43A; VFD1600F43H

Frame H

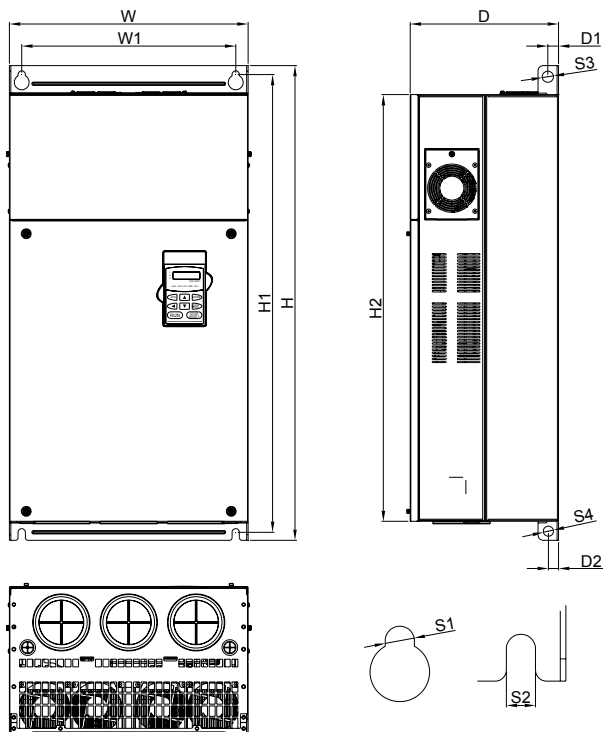

UNIT: mm [inch]

Frame	W	W1	H	H1	H2	H3	D	D1	S1	S2	S3
H1	547.0 [21.54]	480.0 [18.90]	1357.6 [53.45]	1150.0 [45.28]	1119.0 [44.06]	1072.6 [42.23]	360.0 [14.17]	20.00 [0.79]	13.0 [0.51]	13.0 [0.51]	20.00 [0.79]

NOTE

Frame H(H1): VFD1850F43A; VFD1850F43H; VFD2200F43A; VFD2200F43H

VFD-PU01

Unit: mm (inches)

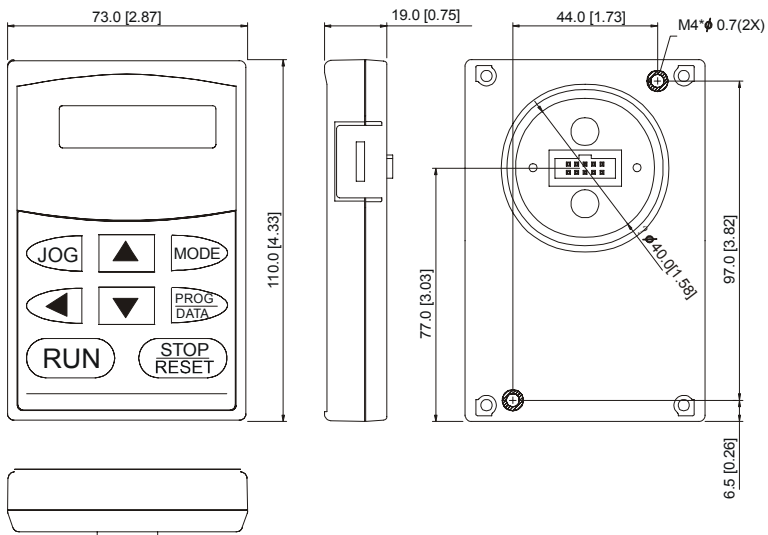

C

KPF-CC01

Unit: mm (inches)

