

# Washing Machine

**LWF27441W**

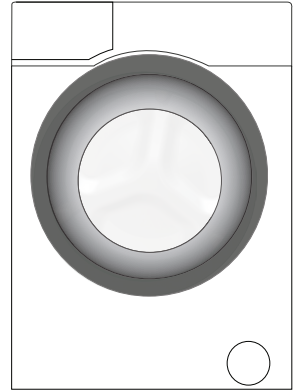

**User's Manual**

# **Blomberg**

# Please read this user manual first!





Dear Customer,

Thank you for preferring a Blomberg product. We hope that you get the best results from your product which has been manufactured with high quality and state-of-the-art technology. Therefore, please read this entire user manual and all other accompanying documents carefully before using the product and keep it as a reference for future use. If you hand over the product to someone else, give this user manual as well. Follow all warnings and information in the user manual.

Remember that this user manual is also applicable for several other models. Differences between models will be identified in the manual.

## Explanation of symbols

Throughout this user manual the following symbols are used:

	Important information or useful hints about usage.
	Warning for hazardous situations with regard to life and property.
	Warning for electric shock.
	Recyclable materials.

Do not dispose of the packaging materials together with domestic or other wastes. Take them to the packaging material collection points designated by the local authorities.

# TABLE OF CONTENTS

<b>1 General safety instructions</b>	<b>5</b>
1.1 Life and property safety	5
1.2 Children's safety	6
1.3 Electrical safety	7
1.4 Hot surface safety	7
<b>2 Important instructions for the environment</b>	<b>8</b>
2.1 Compliance with WEEE Directive	8
2.2 Package information	8
<b>3 Intended use</b>	<b>8</b>
<b>4 Your product</b>	<b>9</b>
4.1 Overview	9
4.2 Package Contents	10
4.3 Technical specifications	11
4.4 Installation	12
4.4.1 Appropriate installation location	12
4.4.2 Removing packaging reinforcement	13
4.4.3 Removing the transportation locks	13
4.4.4 Connecting the water supply	14
4.4.5 Connecting the drain hose to the drain	15
4.4.6 Adjusting the feet	16
4.4.7 Electrical connection	16
4.4.8 Initial use	17
4.5 Preparation	18
4.5.1 Sorting the laundry	18
4.5.2 Preparing laundry for washing	19
4.5.3 Things to be done for energy saving	19
4.5.4 Loading the laundry	20
4.5.5 Correct load capacity	20
4.5.6 Using detergent and softener	20
4.5.7 Tips for efficient washing	23

## TABLE OF CONTENTS

4.6 Operating the product	24
4.6.1 Control panel	24
4.6.2 Programme and consumption table	25
4.6.3 Programme selection	27
4.6.4 Programmes	27
4.6.5 Temperature selection	29
4.6.6 Spin speed selection	29
4.6.7 Auxiliary function selection	30
4.6.8 End Time	31
4.6.9 Starting the programme	32
4.6.10 Loading door lock	32
4.6.11 Changing the selections after programme has started	32
4.6.12 Child Lock	33
4.6.13 Cancelling the programme	33
4.6.14 End of programme	33
4.6.15 Energy saving mode	33
4.7 Maintenance and cleaning	34
4.7.1 Cleaning the detergent drawer	34
4.7.2 Cleaning the loading door and the drum	34
4.7.3 Cleaning the body and control panel	35
4.7.4 Cleaning the water intake filters	35
4.7.5 Draining remaining water and cleaning the pump filter	36

## 5 Troubleshooting

38

# 1 General safety instructions

This section includes security instructions which may help prevent the injuries and material damage risks. All kinds of warranties shall be invalid if these instructions are not observed.

## 1.1 Life and property safety

- ▶ Never place the product on a carpet-covered floor. Electrical parts will get overheated since air cannot circulate from under the device. This will cause problems with your product.
- ▶ Unplug the product if it is not in use.
- ▶ Always have the installation and repairing procedures carried out by an Authorised Service Agent. The manufacturer shall not be held liable for damages that may arise from procedures carried out by unauthorised persons.
- ▶ The water supply and draining hoses must be securely fastened and remain undamaged. Otherwise a water leak may occur.
- ▶ While there is water inside the product, never open the loading door or remove the filter. Otherwise, risk of flooding and injury from hot water will occur.
- ▶ Do not force open the locked loading door. The door can be opened a few minutes after the washing cycle ends. In the case of forcing the loading door to open, the door and the lock mechanism may get damaged.
- ▶ Use detergents, softeners and supplements suitable for automatic washing machines only.
- ▶ Follow the instructions on the label of textiles and the detergent package.

## 1.2 Children's safety

- ▶ This product can be used by children who are at the age of 8 and over and the people whose physical, sensory or mental skills are not fully developed or who do not have necessary required experience and knowledge as long as they are supervised or trained about the safe use of the product and its risks. Children should not play with the device. Cleaning and maintenance works should not be performed by children unless they are supervised by someone. Children of less than 3 years should be kept away unless continuously supervised.
- ▶ Packaging materials may be dangerous for children. Keep packaging materials in a safe place away from reach of children.
- ▶ Electrical products are dangerous for children. Keep children away from the product when it is in use. Do not allow them to play with the product. Use the child lock to prevent children from interfering with the product.
- ▶ Do not forget to close the loading door when leaving the room where the product is located.
- ▶ Store all detergents and additives in a safe place away from the reach of children and close the cover of the detergent container or seal the detergent package.

## 1.3 Electrical safety

- ▶ If the product has a failure, it should not be operated unless it is repaired by an Authorised Service Agent. Risk of electric shock!
- ▶ This product is designed to resume operating in the event of powering on after a power interruption. If you wish to cancel the programme, see "Cancelling the programme" section.
- ▶ Plug the product into a grounded outlet protected by a 13 A fuse. Do not neglect to have the grounding installation made by a qualified electrician. Our company shall not be liable for any damages that will arise when the product is used without grounding in accordance with the local regulations.
- ▶ Do not wash the product by spraying or pouring water onto it! Risk of electric shock!
- ▶ Never touch the power cable plug with wet hands! Do not grab the power cord to unplug the machine, always unplug it by holding the socket with one hand, and pulling the plug with the other hand.
- ▶ Product should be unplugged during installation, maintenance, cleaning and repair procedures.
- ▶ If the power cable is damaged, it must be replaced by the manufacturer, after sales service or a similarly qualified person (preferably an electrician) or someone designated by the importer in order to avoid possible risks.

## 1.4 Hot surface safety



While washing the laundry at high temperatures, the loading door glass will get hot. Considering this fact, during the washing operation keep children away from the loading door of the product to prevent them touching it.

## 2 Important instructions for the environment

### 2.1 Compliance with WEEE Directive



This product complies with EU WEEE Directive (2012/19/EU). This product bears a classification symbol for waste electrical and electronic equipment (WEEE).

This product has been manufactured with high quality parts and materials which can be reused and are suitable for recycling. Do not dispose of the waste product with normal domestic and other wastes at the end of its service life. Take it to the collection center for the recycling of electrical and electronic equipment. Please consult your local authorities to learn about these collection centres.

Compliance with RoHS Directive:

The product you have purchased complies with EU RoHS Directive (2011/65/EU). It does not contain harmful and prohibited materials specified in the Directive.

### 2.2 Package information

Packaging materials of the product are manufactured from recyclable materials in accordance with our National Environment Regulations. Do not dispose of the packaging materials together with the domestic or other wastes. Take them to the packaging material collection points designated by the local authorities.

## 3 Intended use

- This product has been designed for domestic use. It is not for commercial purposes or it should not be used other than its intended use.
- The product must only be used for washing and rinsing of laundry that are marked accordingly.
- The manufacturer waives any responsibility arising from incorrect usage or transportation.
- The service life of your product is 10 years. During this period, original spare parts will be available to operate the appliance properly.



## 4 Your product

### 4.1 Overview

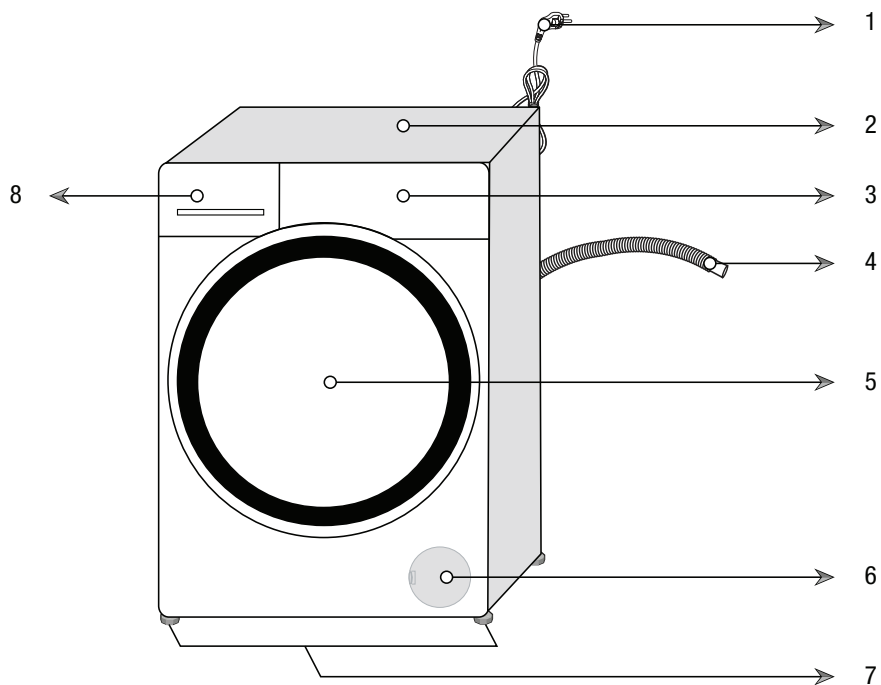

- 1- Power cable
- 2- Top panel
- 3- Control panel
- 4- Drain hose
- 5- Loading door
- 6- Filter cap
- 7- Adjustable feet
- 8- Detergent drawer

## 4.2 Package Contents

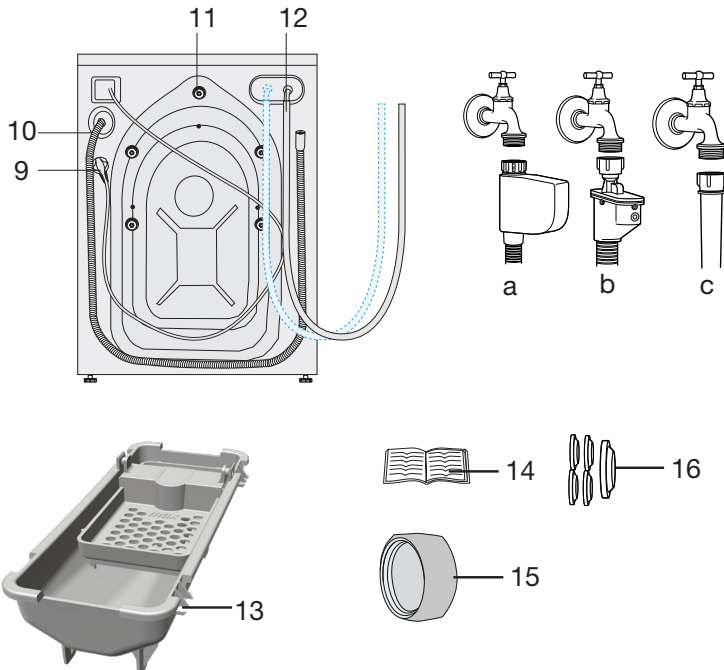

- 9- Power cable
  - 10- Drain hose
  - 11- Transportation safety bolts\*
  - 12- Mains water inlet hose (One of the following filter types is used for the mains hose connection.)
    - a- Electronic water shut-off
    - b- Mechanical water shut-off
    - c- Standard
  - 13- Liquid detergent container\*\*
  - 14- User Manual
  - 15- Blind plug\*\*\*
  - 16- Plastic plug group
- \* Number of transportation safety bolts may change depending on the model of your product.  
\*\* This may be supplied with the machine depending on the model of your product.  
\*\*\* It will be supplied if your product has double water inlet.



Figures in this manual are schematic and may not match the product exactly.

## 4.3 Technical specifications

### Complying Commission Delegated Regulation (EU) No 1061/2010

Supplier name or trademark	Blomberg
Model name	LWF27441W
Rated capacity (kg)	7
Energy efficiency class / Scale from A+++ (Highest Efficiency) to D (Lowest Efficiency)	A+++
Annual Energy Consumption (kWh) <sup>(1)</sup>	169
Energy consumption of the standard 60°C cotton programme at full load (kWh)	0.968
Energy consumption of the standard 60°C cotton programme at partial load (kWh)	0.590
Energy consumption of the standard 40°C cotton programme at partial load (kWh)	0.590
Power consumption in 'off-mode' (W)	0.500
Power consumption in 'left-on mode' (W)	0.500
Annual Water Consumption (l) <sup>(2)</sup>	9020
Spin-drying efficiency class / Scale from A (Highest Efficiency) to G (Lowest Efficiency)	B
Maximum spin speed (rpm)	1400
Remaining moisture Content (%)	53
Standard cotton programme <sup>(3)</sup>	Cotton Eco 60°C and 40°C
Programme time of the standard 60°C cotton programme at full load (min)	208
Programme time of the standard 60°C cotton programme at partial load (min)	183
Programme time of the standard 40°C cotton programme at partial load (min)	183
Duration of the left-on mode (min)	N/A
Airborne acoustical noise emissions washing/spinning (dB)	54/75
Built-in	No
Height (cm)	84
Width (cm)	60
Depth (cm)	50
Net weight (±4 kg.)	71
Single Water inlet / Double Water inlet	• / -
• Available	
Electrical input (V/Hz)	230 V / 50Hz
Total current (A)	10
Total power (W)	2200
Main model code	1010

<sup>(1)</sup> Energy Consumption based on 220 standard washing cycles for cotton programmes at 60°C and 40°C at full and partial load, and the consumption of the low-power modes. Actual energy consumption will depend on how the appliance is used.

<sup>(2)</sup> Water consumption based on 220 standard washing cycles for cotton programmes at 60°C and 40°C at full and partial load. Actual water consumption will depend on how the appliance is used.

<sup>(3)</sup> "Standard 60°C cotton programme" and the "standard 40°C cotton programme" are the standard washing programmes to which the information in the label and the fiche relates and these programmes are suitable to clean normally soiled cotton laundry and that they are the most efficient programmes in terms of combined energy and water consumption.

Technical specifications may be changed without prior notice to improve the quality of the product.

## **4.4 Installation**

- Preparation of the location and electrical, tap water and waste water installations at the place of installation is the customer's responsibility.
- Make sure that the water inlet and discharge hoses as well as the power cable are not folded, pinched or crushed while pushing the product into its place after installation or cleaning procedures.
- The manufacturer shall not be held liable for damages that may arise from procedures carried out by unauthorised persons.
- Prior to installation, visually check if the product has any defects on it. If so, do not have it installed. Damaged products cause risks for your safety.

### **4.4.1 Appropriate installation location**

- Place the product on a hard and level floor. Do not put it onto a carpet with high pile or other similar surfaces.
- If the washing machine and dryer are placed on top of each other, their total weight - when loaded- amounts to 180 kilograms. Place the products on a solid and flat floor that has sufficient load carrying capacity!
- Do not place the product on the power cable.
- Do not install the product in environments where the temperature falls below 0 °C.
- Leave a minimum space of 1 cm between the machine and the furniture.
- On a raised floor, do not place the product next to the edge or on a platform.

## 4.4.2 Removing packaging reinforcement



Tilt the machine backwards to remove the packaging reinforcement. Remove the packaging reinforcement that is attached to the ribbon. Do not attempt this operation alone, get help.

## 4.4.3 Removing the transportation locks

- 1 Loosen all bolts with an appropriate wrench until they turn freely **(C)**.
- 2 Remove the transport safety bolts by rocking them slightly.
- 3 Insert the plastic covers from the bag containing the user manual into the openings on the rear panel. **(P)**

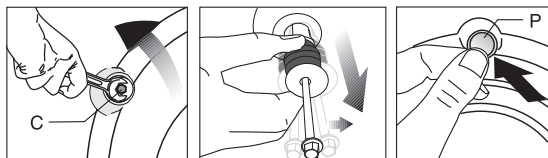

**CAUTION:** Remove the transportation safety bolts before operating the washing machine! Otherwise, the product will be damaged.



Keep the transportation safety bolts in a safe place to reuse when the washing machine needs to be moved again in the future.

Install the transport safety bolts in the reverse order of the disassembly procedure.

Never move the product without the transportation safety bolts properly fixed in place!

## 4.4.4 Connecting the water supply



The water supply pressure required to run the product is between 1 to 10 bars (0.1 - 1 MPa). It is necessary to have 10 - 80 litres of water flowing from the fully open tap in one minute to have your machine run smoothly. Attach a pressure reducing valve if the water pressure is higher.

If you are going to use the double water-inlet product as a single (cold) water-inlet unit, you must install the supplied stopper to the hot water valve before operating the product. (Applies for the products supplied with twin - inlet valves only.)



**CAUTION:** Models with a single water inlet should not be connected to the hot water tap. In such a case the laundry will get damaged or the product will switch to protection mode and will not operate.

**CAUTION:** Do not use old or used water inlet hoses on the new product. It may cause stains on your laundry.

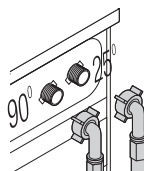

Connect the special water supply hoses supplied with the product to the water inlets on the product. Red hose (left) (max. 90 °C) is for hot water inlet, blue hose (right) (max. 25 °C) is for cold water inlet.

Make sure that the hot and cold water taps are connected correctly when the product is being installed. Otherwise, your laundry will come out hot at the end of the washing process and may be damaged.

- 1 Tighten the nuts of the hose by hand. Never use a tool when tightening the nuts.
- 2 When hose connection is completed, check whether there are no leak problems at the connection points by opening the taps fully. If any leaks occur, turn off the tap and remove the nut. Retighten the nut carefully after checking the seal. In order to prevent the water leaks and resultant damages, keep the taps closed when you do not use the product.

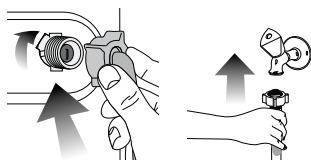

#### 4.4.5 Connecting the drain hose to the drain

- Attach the end of the drain hose directly to the waste water drain, lavatory or bathtub.



**CAUTION:** Your drain house will be flooded if the hose comes out of its housing during water discharge. Moreover, there is risk of scalding due to high washing temperatures! In order to prevent such situations and make sure that the machine performs water intake and discharge processes without any problem, fix the drain hose securely.

- Connect the drain hose to a minimum height of 40 cm and a maximum height of 100 cm.
- In case the drain hose is elevated after laying it on the floor level or close to the ground (less than 40 cm above the ground), water discharge becomes more difficult and the laundry may come out excessively wet. Therefore, follow the heights described in the figure.

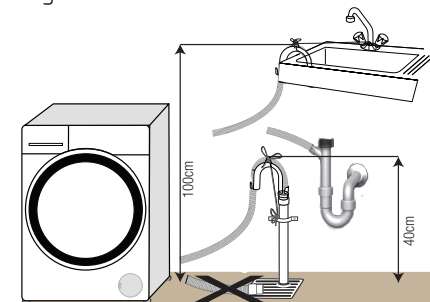

- To prevent the waste water going back into the machine again and to ensure easy drainage, do not immerse the end of the hose into the waste water or do not insert it into the drain for more than 15 cm. If it is too long, cut it short.
- The end of the hose should not be bent, it should not be stepped on and the hose must not be pinched between the drain and the machine.
- If the length of the hose is too short, add an original extension hose. Length of the hose may not be longer than 3.2 m. To avoid water leak failures, the connection between the extension hose and the drain hose of the product must be fitted well with an appropriate clamp as not to come off and/or leak.

## 4.4.6 Adjusting the feet



**CAUTION:** In order to ensure that the product operates more silently and vibration-free, it must stand level and balanced on its feet. Balance the machine by adjusting the feet. Otherwise, the product may move from its place and cause crushing and vibration problems.

**CAUTION:** Do not use any tools to loosen the lock nuts. Otherwise, they will get damaged.

- 1 Loosen the lock nuts on the feet by hand.
- 2 Adjust the feet until the product stands in a stable and balanced way.
- 3 Tighten all lock nuts by hand again.

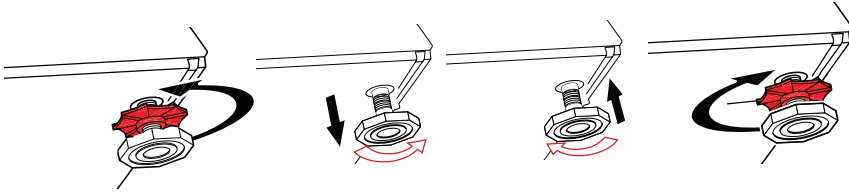

## 4.4.7 Electrical connection

Connect the product to a grounded outlet protected by a 13 A fuse. Our company shall not be liable for any damages that will arise when the product is used without grounding in accordance with the local regulations.

- Connection must comply with national regulations.
- Power cable plug must be within easy reach after installation.
- If the current value of the fuse or breaker in the house is less than 13 Amps, have a qualified electrician install a 13 Amp fuse.
- The voltage specified in the "Technical specifications" section must be equal to your mains voltage.
- Do not make connections via extension cables or multi-plugs.



**WARNING:** Damaged power cables must be replaced by Authorised Service Agents.

### Electrical requirements

Before you insert the plug into the wall socket make sure that the voltage and the frequency shown in the rating label corresponds to your electricity supply.

We recommend that this appliance be connected to the mains supply via a suitable switched and fused socket in a readily accessible position.

Should the mains lead of the appliance become damaged or need replacing at any time, it must be replaced by a special purpose made mains lead which can only be obtained from an Authorised Service Agent.



**WARNING:** This appliance must be earthed

If the fitted moulded plug is not suitable for your socket, then the plug should be cut off and an appropriate plug fitted.

Destroy the old plug, a cut off plug with a bare cord could cause a shock hazard if inserted into a socket elsewhere in the house.



The moulded plug on this appliance incorporates a 13A fuse. Should the fuse need to be replaced an ASTA approved BS1362 fuse of the same rating must be used. Do not forget to refit the fuse cover. In the event of losing the fuse cover, the plug must not be used until a replacement fuse cover has been fitted. Colour of the replacement fuse cover must be the same colour as that visible on the pin face of the plug. Fuse covers are available from any good electrical store.

### Important Fitting a different plug

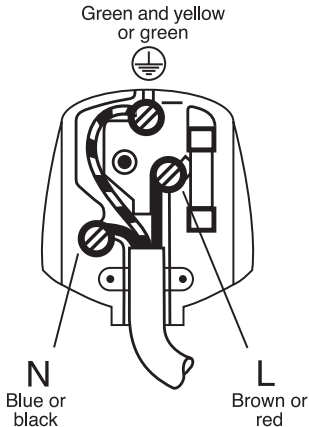

As the colours of the wires in the mains lead of this appliance may not correspond with the coloured markings identifying the terminals on your plug, proceed as follows:

- 1 Connect the green - yellow or green (earth) wire to the terminal in the plug marked 'E' or with the symbol  or coloured green and yellow or green.
- 2 Connect the blue (neutral) wire to the terminal in the plug marked 'N' or coloured black.
- 3 Connect the brown (live) wire to the terminal in the plug marked 'L' or coloured red.

With the alternative plugs a 13A fuse must be fitted either in the plug or adaptor or in the main fuse box. If in doubt contact a qualified electrician.

### Transportation of the product

1. Unplug the product before transporting it.
2. Remove water drain and water supply connections.
3. Drain all water that has remained in the product.
4. Install transportation safety bolts in the reverse order of removal procedure.



Never move the product without the transportation safety bolts properly fixed in place!



**WARNING:** Packaging materials are dangerous to children. Keep packaging materials in a safe place away from reach of the children.

### 4.4.8 Initial use

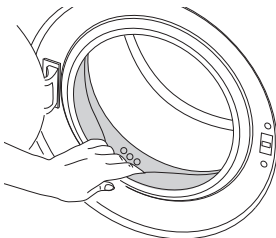

Before starting to use the product make sure that the preparations are made which are in line with the "Important Safety and Environment Instructions" and the instructions in the "Installation" section.

To prepare the product for washing laundry, first perform a Drum Cleaning programme. If this is not available in your machine, apply the method which is described in the section 4.7.2.











































Use an anti-limescale suitable for the washing machines.

Some water might have remained in the product due to the quality control processes in production. It is not harmful for the product.

## 4.5 Preparation

### 4.5.1 Sorting the laundry

- \* Sort laundry according to type of fabric, colour, and degree of soiling and allowable water temperature.
- \* Always obey the instructions given on the garment tags.

LAUNDRY WASH SYMBOLS												
 <b>WASH</b>	Symbols for washing on machine											
	Water temperatures	Maximum	95°C	70°C	60°C	50°C	40°C	30°C				
	Symbol(s)											
 <b>DRYING</b>	Drying symbols											
	Drying settings											
 <b>IRON</b>	Iron											
	Dry or steam	Iron at high temperature		Iron at medium temperature		Iron at low temperature		No ironing		Iron without steam		
	Maximum temperature	200 °C		150 °C		110 °C						
 <b>BLEACH</b>	 All bleaches are allowed			 Bleach (sodium hypochlorite) can be used			 Bleach is not allowed			 Only bleaches without chlorine are allowed		

## 4.5.2 Preparing laundry for washing

- Laundry items with metal attachments such as, underwiring, belt buckles or metal buttons will damage the product. Remove the metal pieces or wash the clothes by putting them in a laundry bag or pillow case.
- Take out all substances in the pockets such as coins, pens and paper clips, and turn pockets inside out and brush. Such objects may damage the product or cause noise problem.
- Put small size clothes such as infant's socks and nylon stockings in a laundry bag or pillow case.
- Place curtains in without compressing them. Remove curtain attachment items.
- Fasten zippers, sew loose buttons and mend rips and tears.
- Wash "Machine washable" or "Hand washable" labeled products only with an appropriate programme.
- Do not wash colours and whites together. New, dark coloured cottons release a lot of dye. Wash them separately.
- Tough stains must be treated properly before washing. If unsure, check with a dry cleaner.
- Only use the dyes / colour changers and descaling agents which are appropriate to machine wash. Always follow the instructions on the package.
- Wash trousers and delicate laundry turned inside out.
- Keep laundry items made of Angora wool in the freezer for a few hours before washing. This will reduce pilling.
- Laundry that are subjected to materials such as flour, lime dust, milk powder, etc. intensely must be shaken off before placing into the product. Such dusts and powders on the laundry may build up on the inner parts of the product in time and can cause damage.

## 4.5.3 Things to be done for energy saving

Following information will help you use the product in an ecological and energy-efficient manner.

- Operate the product in the highest load capacity allowed for the programme you have selected, but do not overload. See, "Programme and consumption table".
- Always follow the instructions on the detergent packaging.
- Wash slightly soiled laundry at low temperatures.
- Use faster programmes for small quantities of lightly soiled laundry.
- Do not use prewash and high temperatures for laundry that is not heavily soiled or stained.
- If you plan to dry your laundry in a dryer, select the highest spin speed recommended during washing process.
- Do not use more detergent than the recommended amount specified on its package.

## 4.5.4 Loading the laundry

1. Open the laundry cover.
2. Put the laundry items into the product in a loose manner.
3. Push and close the loading cover until you hear the locking sound. Ensure that no items are caught in the door. The loading door is locked while a programme is running. The door can only be opened a while after the programme comes to an end. Then you can open the loading cover.

## 4.5.5 Correct load capacity

The maximum load capacity depends on the type of laundry, the degree of soiling and the washing programme desired.

The product automatically adjusts the water amount according to the weight of the laundry put inside it.



**WARNING:** Comply with the information in the section "Programme and consumption table". When overloaded, product's washing performance will drop. Moreover, noise and vibration problems may occur.

## 4.5.6 Using detergent and softener



When using detergent, softener, starch, fabric dye, bleach and whitener, descaling agents; read the manufacturer's instructions written on the package and follow the dosages specified. Use measuring cup if available.



The detergent drawer is composed of three compartments:

- (1) for prewash
- (2) for main wash
- (3) for softener
- (⊗) in addition, there is a siphon piece in the softener compartment.

## Detergent, softener and other cleaning agents

- Add detergent and softener before starting the washing programme.
- While the washing cycle is in progress, do not leave the detergent dispenser open!
- When using a programme without prewash, do not put any detergent into the prewash compartment (compartment nr. "1").
- In a programme with prewash, do not put liquid detergent into the prewash compartment (compartment nr. "1").
- Do not select a programme with prewash if you are using a detergent bag or dispensing ball. Place the detergent bag or the dispensing ball directly among the laundry in the product.
- If you are using liquid detergent, do not forget to place the liquid detergent container into the main wash compartment (compartment number "2").

## Choosing the detergent type

Detergent type to be used depends on the fabric type and colour.

- Use different detergents for coloured and white laundry.
- Wash your delicate clothes only with special detergents (liquid detergent, wool shampoo, etc.) used solely for delicate clothes.
- When washing dark coloured clothes and quilts, it is recommended to use liquid detergent.
- Wash woollens with special detergent made specifically for woollens.



**CAUTION:** Use only detergents manufactured specifically for washing machines.

**CAUTION:** Do not use soap powder.

## Adjusting detergent amount

The amount of washing detergent to be used depends on the amount of laundry, the degree of soiling and water hardness.

- Do not use amounts exceeding the dosage quantities recommended on the detergent package to avoid problems of excessive foam, poor rinsing, financial savings and finally, environmental protection.
- Use lesser detergent for small amounts or lightly soiled clothes.

## Using softeners

Pour the softener into the softener compartment of the detergent drawer.

- Do not exceed the (>max<) level sign on the softener compartment.
- If the softener has lost its fluidity, dilute it with water before putting it in the detergent compartment.

## Using liquid detergents

### If the product contains a liquid detergent cup:

- Put the liquid detergent container into the compartment no "2".
- If the liquid detergent lost its fluidity, dilute it with water before putting it into the detergent container.



### If the product does not contain a liquid detergent cup:

- Do not use liquid detergent for the prewash in a programme with prewash.
- Liquid detergent stains your clothes when used with "End Time" function to started delayed. If you are going to use the End Time function, do not use liquid detergent.

## Using gel and tablet detergent

- If the gel detergent thickness is fluidal and your product does not contain a special liquid detergent cup, put the gel detergent into the main wash detergent compartment during first water intake. If your product contains a liquid detergent cup, fill the detergent into this cup before starting the programme.
- If the gel detergent thickness is not fluidal or in the shape of capsule liquid tablet, put it directly into the drum before washing.
- Put tablet detergents into the main wash compartment (compartment nr. "2") or directly into the drum before washing.

## Using starch

- Put the liquid soda, powder soda or the fabric dye into the softener compartment. Do not use softener and starch together in a washing cycle.
- Wipe the inside of the product with a damp and clean cloth after using starch.

## Using limescale remover

- When required, use limescale removers manufactured specifically for washing machines only.

## Using bleaches

- Add the bleach at the beginning of the washing cycle by selecting a prewash programme. Do not put detergent in the prewash compartment. As an alternative application, select a programme with extra rinse and add the bleaching agent while the product is taking water from the detergent compartment during first rinsing step.
- Do not use bleaching agent and detergent by mixing them.
  - Use just a little amount (1/2 tea glass - approx. 50 ml) of bleaching agent and rinse the clothes very well as it causes skin irritation.
  - Do not pour the bleach onto the laundry.
  - Do not use it with the coloured items.
  - When using oxygen-based whitener, select a programme which washes the laundry at a low temperature.
  - Oxygen-based whiteners can be used together with the detergent. However, if its thickness is not the same with the detergent, put the detergent first into the compartment nr. "2" in the detergent drawer and wait until the detergent flows while the product is taking in water. While the machine continues taking in water, add whitener in the same compartment.

## 4.5.7 Tips for efficient washing

		Clothes			
		Light Colours and Whites	Colours	Black/Dark Colours	Delicates/ Woollens/ Silks
		(Recommended temperature range based on soiling level: 40-90 °C)	(Recommended temperature range based on soiling level: cold -40 °C)	(Recommended temperature range based on soiling level: cold -40 °C)	(Recommended temperature range based on soiling level: cold -30 °C)
Soiling Level	Heavily Soiled	It may be necessary to pre-treat the stains or perform prewash. Powder and liquid detergents recommended for whites can be used at dosages recommended for heavily soiled clothes. It is recommended to use powder detergents to clean clay and soil stains and the stains that are sensitive to bleaches.	Powder and liquid detergents recommended for colours can be used at dosages recommended for heavily soiled clothes. It is recommended to use powder detergents to clean clay and soil stains and the stains that are sensitive to bleaches. Detergents which do not contain bleach should be used.	Liquid detergents suitable for colours and dark colours can be used at dosages recommended for heavily soiled clothes.	Prefer liquid detergents produced for delicate clothes. woollen and silk clothes must be washed with special woollen detergents.
	Normally Soiled	Powder and liquid detergents recommended for whites can be used at dosages recommended for normally soiled clothes.	Powder and liquid detergents recommended for colours can be used at dosages recommended for normally soiled clothes. Detergents which do not contain bleach should be used.	Liquid detergents suitable for colours and dark colours can be used at dosages recommended for normally soiled clothes.	Prefer liquid detergents produced for delicate clothes. woollen and silk clothes must be washed with special woollen detergents.
	Lightly Soiled	Powder and liquid detergents recommended for whites can be used at dosages recommended for lightly soiled clothes.	Powder and liquid detergents recommended for colours can be used at dosages recommended for lightly soiled clothes. Detergents which do not contain bleach should be used.	Liquid detergents suitable for colours and dark colours can be used at dosages recommended for lightly soiled clothes.	Prefer liquid detergents produced for delicate clothes. woollen and silk clothes must be washed with special woollen detergents.

## 4.6 Operating the product

### 4.6.1 Control panel

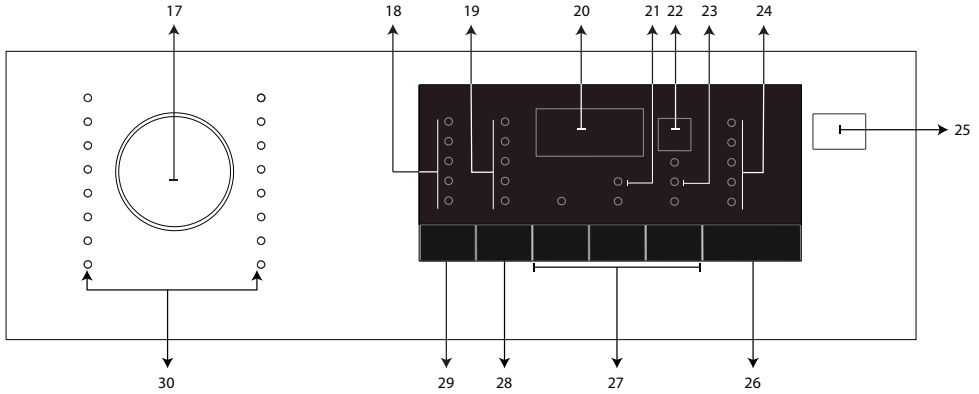

- 17 - Programme selection knob
- 18 - Temperature indicator
- 19 - Spin speed indicator
- 20 - Duration information display
- 21 - Child lock enabled indicator
- 22 - End Time Setting button
- 23 - Door lock enabled indicator
- 24 - Programme Follow-up indicator
- 25 - On / Off button
- 26 - Start / Pause button
- 27 - Auxiliary function buttons
- 28 - Spin speed adjustment button
- 29 - Temperature adjustment button
- 30 - Programme selection indicator



## 4.6.2 Programme and consumption table

EN						Auxiliary functions			
Programme (°C)		Max. Load (kg)	Water Consumption (l)	Energy Consumption (kWh)	Max. Speed***	Prewash	Shorter Wash	Rinse Plus	Selectable temperature range °C
Cottons Eco	60**	7	44	0.97	1400				Cold-60
	60**	3.5	38	0.59	1400				Cold-60
	40**	3.5	38	0.59	1400				Cold-60
Hygiene+	90	7	85	1.90	1400			*	30-90
Shirts	60	3.5	57	1.00	800	•	•	•	Cold-60
Mix 40	40	3.5	60	0.70	1000	•	•		Cold-40
Sportswear	40	3	55	0.55	1000	•	•		Cold-40
Dark Wash	40	3	60	0.60	1000	•		*	Cold-40
Jeans	40	3	60	0.65	1000	•	•		Cold-60
Hand Wash	30	1	40	0.25	1200				Cold-30
Delicates 20°	20	3.5	45	0.15	1200			•	20
Mini 14'	30	2	35	0.15	1400			•	Cold-30
Fast Full Load	90	7	67	2.00	1400			•	Cold-90
	60	7	67	1.10	1400			•	Cold-90
	30	7	67	0.25	1400			•	Cold-90
Woollens	40	1.5	49	0.25	1200			•	Cold-40
Synthetics	60	3	52	1.10	1200	•	•	•	Cold-60
	40	3	49	0.60	1200	•	•	•	Cold-60
Cottons	90	7	70	2.20	1400	•	•	•	Cold-90
	60	7	70	1.55	1400	•	•	•	Cold-90
	40	7	67	0.90	1400	•	•	•	Cold-90

• : Selectable.

\* : Automatically selected, no cancelling.



\*\* : Energy Label programme (EN 60456 Ed.3)

\*\*\* : If maximum spin speed of the product is lower then this value, you can only select up to the maximum spin speed.

\*\*\*\* : Programme detects the type and quantity of the laundry to automatically adjust water and energy consumption and programme time.

- : See the programme description for maximum load.



\*\* "Cotton Economic 40°C" and "Cotton Economic 60°C" are standard programmes. These programmes are known as '40°C cotton standard programme' and '60°C cotton standard programme' and indicated with the   symbols on the panel.



The auxiliary functions in the table may vary according to the model of your product.

Water and power consumption may vary subject to the changes in water pressure, water hardness and temperature, ambient temperature, type and amount of laundry, selection of auxiliary functions and spin speed, and changes in electric voltage.

You can see the washing time of the programme you have selected on the display of the product. It is normal that small differences may occur between the time shown on the display and the real washing time.

Auxiliary function selection modes can be changed by the manufacturing company. Existing selection modes can be removed or new selection modes can be added.

"The manufacturer reserves the right to make modifications in the programmes and auxiliary functions given in the table. While these modifications will not change the product performance, programme steps and durations can be changed."

#### Indicative values for Synthetics programmes (EN)

	Load (kg)	Water Consumption (l)	Energy Consumption (kWh)	Programme Duration (min) *	Remaining Moisture Content (%) **	
					≤ 1000 rpm	> 1000 rpm
Synthetics 60	3	52	1.10	105 / 135	45	40
Synthetics 40	3	49	0.60	105 / 135	45	40

\* You can see the washing time of the programme you have selected on the display of the machine. It is normal that small differences may occur between the time shown on the display and the real washing time.

\*\* Remaining moisture content values may differ according to the selected spin speed.

### 4.6.3 Programme selection

- 1 Determine the programme suitable for the type, quantity and soiling level of the laundry in accordance with the "4.6.2 Programme and consumption table".

	Programmes are limited with the highest spin speed appropriate for that particular type of fabric.
	When selecting a programme, always consider the type of fabric, colour, degree of soiling and permissible water temperature.
	Always select the relevant lowest required temperature. Higher temperature means higher power consumption.

- 2 Select the desired programme with the **Programme Selection** knob.

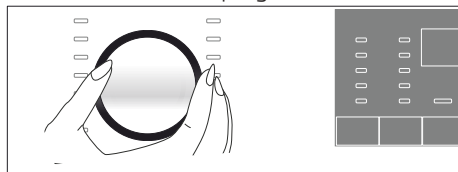

### 4.6.4 Programmes

#### • Cottons Eco

Use to wash your normally soiled, durable cotton and linen laundry. Although it washes longer than all other programmes, it provides high energy and water savings. Actual water temperature may be different from the stated wash temperature. When you load the machine with less laundry (e.g. ½ capacity or less), periods in programme stages may automatically get shorter. In this case, energy and water consumption will decrease more, providing a more economic wash. This programme is available in the models with the remaining time indicator.

#### • Cottons

Use for your cotton laundry (such as bed sheets, duvet and pillowcase sets, towels, bathrobes, underwear, etc.). Your laundry will be washed with vigorous washing action for a longer washing cycle.

#### • Synthetics

Use to wash your synthetic clothes (shirts, blouses, synthetic/cotton blends, etc.). It washes with a gentle action and has a shorter washing cycle compared to the Cottons programme.

For curtains and tulle, use the Synthetic 40°C programme with prewash and anti-creasing functions selected. As their meshed texture causes excessive foaming, wash the veils/ tulle by putting little amount of detergent into the main wash compartment. Do not put detergent in the prewash compartment.

#### • Woollens

Use to wash your woollen clothes. Select the appropriate temperature complying with the tags of your clothes. Use appropriate detergents for woollens.



"The wool wash cycle of this machine has been approved by The Woolmark Company for the washing of machine washable wool products provided that the products are washed according to the instructions on the garment label and those issued by the manufacturer of this washing machine. M1429."

"In UK, Eire, Hong Kong and India the Woolmark trade mark is a Certification trade mark."

- **Hand Wash**

Use to wash your woollen/delicate clothes that bear "not machine-washable" tags and for which hand wash is recommended. It washes laundry with a very gentle washing action to not to damage clothes.

- **Hygiene+**

Use this programme to wash baby laundry, and the laundry that belongs to allergic persons. Longer heating time and an additional rinsing step provide a higher level of hygiene.

- **Dark Wash**

Use this programme to wash your dark coloured laundry or coloured laundry that you do not want them get faded. Washing is performed with little mechanic action and at low temperatures. It is recommended to use liquid detergent or woollen shampoo for dark coloured laundry.

- **Shirts**

Use to wash the shirts made of cotton, synthetic and synthetic blended fabrics together.

- **Mix 40**

Use to wash your cotton and synthetic clothes together without sorting them.

- **Delicates 20°**

Use to wash your clothes that require sensitive washing. It washes with more gentle washing action compared to the synthetics programme and does not make intermediate spins.

- **Mini 14'**

Use to wash your lightly soiled and unstained cotton laundry in a short time.

- **Fast Full Load**

Use to wash your lightly soiled and unstained cotton laundry in a short time.

- **Sportswear**

Use this programme to wash your garments that are worn for a short time such as sportswear. It is suitable to wash little amount of cotton / synthetic blended garments.

- **Jeans**

Use this programme to wash clothes such as trousers, jackets, vests, etc., made of denim. Lower mechanical movement in washing cycles and lower rpm in spinning cycles are used to prevent washing damages on stoned jeans as well as to ensure a longer life.

- **Spin+Pump**

Use to drain the water in the product.

- **Rinse**

Use when you want to rinse or starch separately.

## 4.6.5 Temperature selection

Whenever a new programme is selected, the recommended temperature for the selected programme appears on the temperature indicator.

To decrease the temperature, press the Temperature Adjustment button. Temperature will decrease gradually.

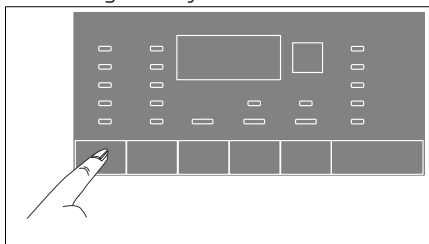

If the programme has not reached the heating step, you can change the temperature without switching the product to Pause mode.

## 4.6.6 Spin speed selection

Whenever a new programme is selected, the recommended spin speed of the selected programme is displayed on the spin speed indicator.

To decrease the spin speed, press the Spin Speed Adjustment button. Spin speed decreases gradually.

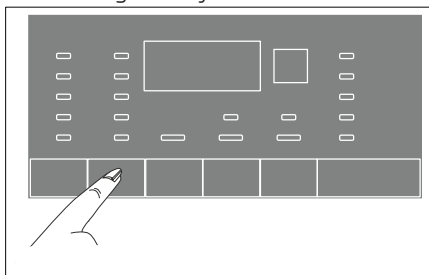

Then, depending on the model of the product, "Rinse Hold" and "No Spin" options appear on the display. See "4.6.7 Auxiliary function selection" section for explanations of these options.

## Rinse Hold

If you are not going to unload your clothes immediately after the programme completes, you can use rinse hold function to keep your laundry in the final rinsing water in order to prevent them from getting wrinkled when there is no water in the product. Press Start/ Pause button after this process if you want to drain the water without spinning your laundry. Programme will resume and complete after draining the water.

If you want to spin the laundry held in water, adjust the Spin Speed and press Start / Pause button. The programme resumes. Water is drained, laundry is spun and the programme is completed.



If the programme has not reached the spinning step, you can change the spinning speed without switching the product to Pause mode.

## 4.6.7 Auxiliary function selection

Select the desired auxiliary functions before starting the programme.

The chosen auxiliary function indicator lights up.

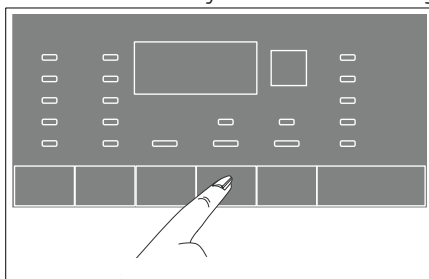

When you try to change an auxiliary function that is not allowed to be selected with the current programme, indicator light of the relevant auxiliary function will flash and an audio warning is given.

Furthermore, you may also select or cancel auxiliary functions that are suitable to the running programme after the washing cycle starts. If the wash cycle has reached a point where no auxiliary function can be selected, an audio warning will be given and the related auxiliary function's light will flash.



Some functions cannot be selected together. If a second auxiliary function conflicting with the first one is selected before starting the product, the function selected first will be cancelled and the second auxiliary function selection will remain active. For example, if you want to select Quick Wash after you have selected the Additional Water, Additional Water will be cancelled and Quick Wash will remain active.

An auxiliary function that is not compatible with the programme cannot be selected. (See, "4.6.2 Programme and consumption table".)

Some programmes have auxiliary functions that must be operated simultaneously. Those functions cannot be cancelled. The frame of the auxiliary function will not be illuminated, only inner area will be illuminated.

### • Prewash

A Prewash is only worthwhile for heavily soiled laundry. Not using the Prewash will save energy, water, detergent and time.

### • Rinse Plus

This function enables the product to make another rinse in addition to the one already made after the main wash. Thus, the risk for sensitive skins (babies, allergic skins, etc.) to be effected by the minimal detergent remnants on the laundry can be reduced.

### • Shorter Wash

This function can be used in Cottons and Synthetics programmes. It decreases the washing times and also the number of rinsing steps for lightly soiled laundry.



When you select this function, load your product with half of the maximum laundry specified in the programme table.

## 4.6.8 End Time

With the End Time function, the startup of the programme may be delayed up to 24 hours. After pressing End Time button, the programme's estimated ending time is displayed. If the End Time is adjusted, End Time indicator is illuminated.

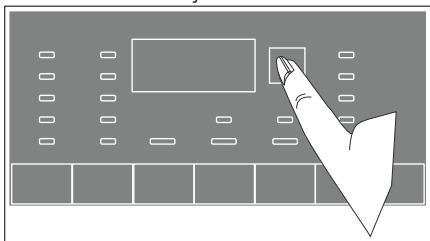

- 1 Open the loading door, place the laundry and put detergent, etc.
- 2 Select the washing programme, temperature, spin speed and, if required, the auxiliary functions.
- 3 Set the end time of your choice by pressing the End Time button. End Time indicator illuminates.
- 4 Press Start / Pause button. Time countdown starts. ":" sign in the middle of the end time on the display starts flashing.

### Adjusting the end time

If you want to cancel End Time function, press On / Off button to turn off and on the product.



Do not use liquid detergents when you activate End Time function! There is the risk of staining of the clothes.



Additional laundry may be loaded to the product during the End Time countdown period. At the end of the countdown, End Time indicator turns off, washing cycle starts and the time of the selected programme appears on the display.

When the End Time selection is completed, the time appears on the screen is the total of the end time chosen plus the duration of the selected programme.

## 4.6.9 Starting the programme

1. Press Start / Pause button to start the programme.
2. Programme follow-up light showing the startup of the programme will turn on.



If no programme is started or no key is pressed within 10 minute during programme selection process, the product will turn off automatically. Display and all indicators will turn off. If you press on the On / Off button, the programme information set as default will be displayed.

## 4.6.10 Loading door lock

There is a locking system on the loading door of the product that prevents opening of the door in cases when the water level is unsuitable.

"Door Locked" light in the panel turns on when the loading door is locked.

## 4.6.11 Changing the selections after programme has started

After the programme has started you can make the following changes.

### Switching the product to pause mode

Press the Start/Pause button to switch the machine to pause mode while a programme is running. The light of the step and Start/Pause which the machine is in, starts flashing in the Programme Follow-up indicator to show that the machine has been switched to the pause mode. Also loading door light blinks until the door is ready to be opened. When the loading door is ready to be opened Loading Door light will turn off, programme step light and Start / Pause light will continue to flash.

Also, when the loading door is ready to be opened, Loading Door light will also turn off in addition to the programme step light.

### Changing the auxiliary function, speed and temperature

Depending on the step the programme has reached, you can cancel or select the auxiliary functions. See "4.6.7 Auxiliary function selection".

Also you can change temperature and cycle adjustments. See "4.6.5 Temperature selection" and "4.6.6 Spin speed selection".



If no change is allowed, the relevant light will flash for 3 times.

## Adding or taking out laundry

1. Press the Start / Pause button to switch the product to pause mode. The programme follow-up light of the relevant step during which the machine was switched into the pause mode will flash.
2. Wait until the Loading Door can be opened.
3. Open the Loading Door and add or take out the laundry.
4. Close the Loading Door.
5. Make changes in auxiliary functions, temperature and speed settings if necessary.
6. Press the Start / Pause button to operate the product.



## 4.6.12 Child Lock

Use Child Lock function to prevent children from tampering with the product. Thus you can avoid any changes in a running programme.



You can switch on and off the product with On / Off button when the Child Lock is active. When you switch on the product again, programme will resume from where it has stopped.

### To activate the Child Lock:

Press and hold **2nd Auxiliary Function** button for 3 seconds. In the programme selection display on the panel, "Child lock enabled" light will turn on. When this light is on you can stop pressing on **2nd Auxiliary Function** button.

### To deactivate the child lock:

Press and hold **2nd Auxiliary Function** button for 3 seconds. In the programme selection display on the panel, "Child lock enabled" light will turn off.

## 4.6.13 Cancelling the programme

The programme is cancelled when the product is turned off and on again. Press and hold **On / Off** button for 3 seconds.



If you press On / Off button when the Child Lock is enabled, the programme will not be cancelled. You should cancel the Child Lock first.

If you want to open the loading door after you have cancelled the programme but it is not possible to open the loading door since the water level in the product is above the loading door opening, then turn the Programme Selection knob to Pump+Spin programme and discharge the water in the product.

## 4.6.14 End of programme

"End" warning appears on the display when the programme is completed.

If you do not press any button for 10 minutes, the product will turn off automatically. Display and all indicators are turned off.

Completed programme steps will be displayed if you press On / Off button.

## 4.6.15 Energy saving mode

If no action is taken for 2 minutes after turning on the product with On / Off button or after the chosen programme ends, the product will switch to energy saving mode automatically. The brightness of the indicator lights will decrease. This display will be dimmed completely if programme time display is available.

If you turn the programme button or touch any button, the lights will switch back to previous position.



This is a feature of this product, and not an error.

## 4.7 Maintenance and cleaning

Service life of product extends and frequently experienced problems will be reduced if it is cleaned at regular intervals.

### 4.7.1 Cleaning the detergent drawer

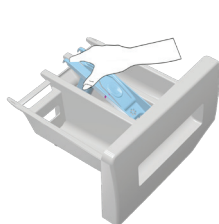

Clean the detergent drawer at regular intervals (every 4-5 washing cycles) as shown below in order to prevent accumulation of powder detergent in time.

If more than normal amount of water and softener mixture starts to gather in the softener compartment, the siphon must be cleaned.

- 1 Press the indicated point on the siphon in the softener compartment and pull the drawer towards you until the compartment is removed from the machine.
- 2 Lift the rear part of the siphon to remove it as illustrated.
- 3 Wash the detergent drawer and the siphon with plenty of lukewarm water in a washbasin. In order to prevent the residues to contact your skin, clean it with an appropriate brush by wearing a pair of gloves.
- 3 Insert the drawer back into its place after cleaning and make sure that it is seated well.

### 4.7.2 Cleaning the loading door and the drum

For products with drum cleaning programme, please see Operating the product - Programmes.

For products without drum cleaning, follow the below steps **to clean the drum:**

Select **Additional Water** or **Extra Rinse** auxiliary functions. Use a Cottons programme without pre-wash. Set **the temperature to the level recommended on the drum cleaning agent which can be provided from authorized services.** Apply this procedure **without any laundry in the product.** Before starting the programme, put 1 pouch of special drum cleaning agent (if the special agent could not be supplied, put max. 100 g of powder anti-limescale) into the main wash detergent compartment (compartment no. „2“). If the anti-limescale is in tablet form, put only one tablet into the main wash compartment no. „2“. Dry the inside of the bellow with a clean piece of cloth after the programme has come to an end.



Repeat Drum Cleaning process in every 2 months.

Use an anti-limescale suitable for washing machines.

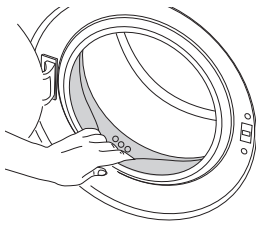

After every wash make sure that no foreign substance is left in the drum.  
If the holes on the door bellow shown in the figure are blocked, open the holes using a toothpick.  
Foreign metal substances will cause rust stains in the drum. Clean the stains on the drum surface by using cleaning agents for stainless steel.  
Never use steel wool or wire wool. These will damage the painted, chromated and plastic surfaces.

#### 4.7.3 Cleaning the body and control panel

Wipe the body of the product with soapy water or non-corrosive mild gel detergents as necessary, and dry with a soft cloth.  
Use only a soft and damp cloth to clean the control panel.

#### 4.7.4 Cleaning the water intake filters

There is a filter at the end of each water intake valve at the rear of the product and also at the end of each water intake hose where they are connected to the tap. These filters prevent foreign substances and dirt in the water to enter the product. Filters should be cleaned as they do get dirty.

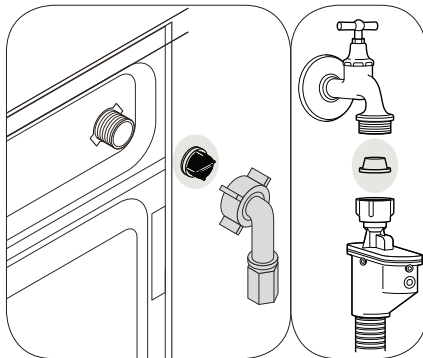

1. Close the taps.
2. Remove the nuts of the water intake hoses to access the filters on the water intake valves. Clean them with an appropriate brush. If the filters are too dirty, remove them from their places with a pliers and clean in this way.
3. Take out the filters on the flat ends of the water intake hoses together with the gaskets and clean thoroughly under running water.
4. Replace the seals and filters carefully and tighten their nuts by hand.

## 4.7.5 Draining remaining water and cleaning the pump filter

The filter system in your product prevents solid items such as buttons, coins and fabric fibres clogging the pump impeller during discharge of washing water. Thus, the water will be discharged without any problem and the service life of the pump will extend.

If the product fails to drain water inside it, the pump filter is clogged. Filter must be cleaned whenever it is clogged or every 3 months. Water must be drained off first to clean the pump filter.

In addition, prior to transporting the product (e.g., when moving to another house) water should be drained completely.



**CAUTION:** Foreign substances left in the pump filter may damage your product or may cause noise problem.

**CAUTION:** In regions where freezing is possible, the supply tap must be closed, system hose must be removed and the water inside the product must be drained when the product is not in use.

**CAUTION:** After each use, turn off the water tap to which the mains hose is connected.

### In order to clean the dirty filter and discharge the water:

1. Unplug the product to cut off the supply power.



**CAUTION:** Temperature of the water inside the product may rise up to 90 °C. To avoid the burning risk, clean the filter after the water inside the product is cooled down.

2. Open the filter cover.



3 Follow the below procedures in order to drain water.

**If the product has an emergency water draining hose, in order to drain the water:**

- a Pull the emergency draining hose out from its seat
- b Place a large container at the end of the hose. Drain the water into the container by pulling out the plug at the end of the hose. When the container is full, block the inlet of the hose by replacing the plug. After the container is emptied, repeat the above procedure to drain the water in the product completely.
- c When draining of water is finished, close the end by the plug again and fix the hose in its place.
- d Turn and remove the pump filter.

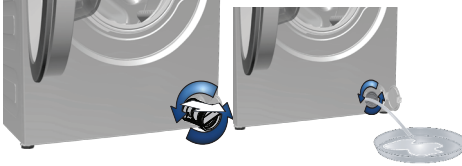

- 4 Clean any residues inside the filter as well as fibers, if any, around the pump impeller region.
5. Replace the filter.
6. If the filter cap is composed of two pieces, close the filter cap by pressing on the tab. If it is one piece, seat the tabs in the lower part into their places first, and then press the upper part to close.

## 5 Troubleshooting

Problem	Reason	Solution
Program does not start after closing the door	Start / Pause / Cancel button was not pressed.	Æ*Press the Start / Pause / Cancel button.
Programme cannot be started or selected.	The product may have switched to self protection mode due to a supply problem (line voltage, water pressure, etc.).	Æ Press and hold On / Off button for 3 seconds to reset the product to factory settings. (See. Cancelling the programme")
Water inside the product.	Some water might have remained in the product due to the quality control processes in the production.	ÆThis is not a failure; water is not harmful to the product.
The product does not take water in.	Tap is turned off.	ÆTurn on the taps.
	Water inlet hose is bent or crushed.	ÆReposition the hose.
	Water inlet filter is clogged.	ÆClean the filter.
	Loading door may be open.	ÆClose the door.
The product does not drain water.	Water drain hose might be clogged or twisted.	ÆClean or reposition the hose.
	Pump filter is clogged.	ÆClean the pump filter.
Product vibrates or makes noise.	Product might be standing unbalanced.	ÆSteady the product by adjusting the feet.
	A hard substance might have entered into the pump filter.	ÆClean the pump filter.
	Transportation safety bolts are not removed.	ÆRemove the transportation safety bolts.
	Laundry quantity in the product might be too little.	ÆAdd more laundry to the product.
	Excessive laundry might be loaded in the product.	ÆTake out some of the laundry from the product or distribute the load by hand to balance it evenly in the product.
	Product might be leaning on a rigid item.	ÆMake sure that the product is not leaning on anything.
There is water leaking from the bottom of the product.	Water drain hose might be clogged or twisted.	ÆClean or reposition the hose.
	Pump filter is clogged.	ÆClean the pump filter.
Product stopped shortly after the programme started.	Machine might have stopped temporarily due to low voltage.	ÆProduct will resume running when the voltage restores to the normal level.
Product directly discharges the water it takes in.	Draining hose might not be at adequate height.	ÆConnect the water draining hose as described in the operation manual.
No water can be seen in the product during washing.	Water is below the visible area of the door.	ÆThis is not a failure. Environmentalist washing machines use less water.

<b>Problem</b>	<b>Reason</b>	<b>Solution</b>
Loading door cannot be opened.	The cover lock is activated due to the water level inside the product.	Æ Drain the water by running the Pump or Spin programme.
	Product is heating up the water or it is at the spinning cycle.	Æ Wait until the programme completes.
	Child lock is engaged. Door lock will be deactivated a couple of minutes after the programme has come to an end.	Æ Wait for a couple of minutes for deactivation of the door lock.
Washing takes longer time than specified in the manual.(*)	Water pressure is low.	Æ Product waits until taking in adequate amount of water to prevent poor washing quality due to the decreased amount of water. Therefore, the washing time extends.
	Voltage might be low.	Æ Washing time is prolonged to avoid poor washing results when the supply voltage is low.
	Input temperature of water might be low.	Æ Required time to heat up the water extends in cold seasons. Also, washing time can be lengthened to avoid poor washing results.
	Number of rinses and/or amount of rinse water might have increased.	Æ Product increases the amount of rinse water when good rinsing is needed and adds an extra rinsing step if necessary.
	Excessive foam might have occurred and automatic foam absorption system might have been activated due to too much detergent usage.	Æ Use recommended amount of detergent.
Programme time does not countdown. (On models with display) (*)	Timer may stop during water intake.	Æ Timer indicator will not countdown until the product takes in adequate amount of water. The product will wait until there is sufficient amount of water to avoid poor washing results due to lack of water. Timer indicator will resume countdown after this.
	Timer may stop during heating step.	Æ Timer indicator will not countdown until the product reaches the selected temperature.
	Timer may stop during spinning step.	Æ Automatic unbalanced load detection system might be activated due to the unbalanced distribution of the laundry in the product.
Programme time does not countdown. (*)	There might be unbalanced load in the product.	Æ Automatic unbalanced load detection system might be activated due to the unbalanced distribution of the laundry in the product.

<b>Problem</b>	<b>Reason</b>	<b>Solution</b>
Product does not switch to spinning step. (*)	There might be unbalanced load in the product.	ÆAutomatic unbalanced load detection system might be activated due to the unbalanced distribution of the laundry in the product.
	The product will not spin if water is not drained completely.	ÆCheck the filter and the draining hose.
	Excessive foam might have occurred and automatic foam absorption system might have been activated due to too much detergent usage.	Æ Use recommended amount of detergent.
Washing performance is poor: Laundry turns Grey. (**)	Insufficient amount of detergent has been used over a long period of time.	ÆUse the recommended amount of detergent appropriate for water hardness and the laundry.
	Washing was made at low temperatures for a long time.	ÆSelect the proper temperature for the laundry to be washed.
	Insufficient amount of detergent is used with hard water.	ÆUsing insufficient amount of detergent with hard water causes the soil to stick on the cloth and this turns the cloth Grey in time. It is difficult to eliminate Greying once it happens. Use the recommended amount of detergent appropriate for water hardness and the laundry.
	Excessive amount of detergent was used.	ÆUse the recommended amount of detergent appropriate for water hardness and the laundry.
Washing performance is poor: Stains persist or the laundry is not whitened. (**)	Insufficient amount of detergent is used.	ÆUse the recommended amount of detergent appropriate for water hardness and the laundry.
	Excessive laundry was loaded in.	ÆDo not load the product in excess. Load with amounts recommended in the "4.6.2 Programme and consumption table".
	Wrong programme and temperature were selected.	ÆSelect the proper programme and temperature for the laundry to be washed.
	Wrong type of detergent is used.	ÆUse original detergent appropriate for the product.
	Excessive amount of detergent was used.	ÆPut the detergent in the correct compartment. Do not mix the bleaching agent and the detergent with each other.



<b>Problem</b>	<b>Reason</b>	<b>Solution</b>
Washing performance is poor: Oily stains appeared on the laundry. (**)	Regular drum cleaning is not applied.	ÆClean the drum regularly. For this procedure, please see "4.7.2 Cleaning the loading door and the drum".
Washing performance is poor: Clothes smell unpleasantly. (**)	Odours and bacteria layers are formed on the drum as a result of continuous washing at lower temperatures and/or in short programmes.	ÆLeave the detergent drawer as well as the loading door of the product ajar after each washing. Thus, a humid environment favorable for bacteria cannot occur in the machine.
Colour of the clothes faded. (**)	Excessive laundry was loaded in.	ÆDo not load the product in excess.
	Detergent in use is damp.	Æ Keep detergents closed in an environment free of humidity and do not expose them to excessive temperatures.
	A higher temperature is selected.	ÆSelect the proper programme and temperature according to the type and soiling degree of the laundry.
It does not rinse well.	The amount, brand and storage conditions of the detergent used are inappropriate.	ÆUse a detergent appropriate for the washing machine and your laundry. Keep detergents closed in an environment free of humidity and do not expose them to excessive temperatures.
	Detergent is put in the wrong compartment.	ÆIf detergent is put in the prewash compartment although prewash cycle is not selected, the product can take this detergent during rinsing or softener step. Put the detergent in the correct compartment.
	Pump filter is clogged.	ÆCheck the filter.
	Drain hose is folded.	ÆCheck the drain hose.
Laundry became stiff after washing. (**)	Insufficient amount of detergent is used.	ÆUsing insufficient amount of detergent for the water hardness can cause the laundry to become stiff in time. Use appropriate amount of detergent according to the water hardness.
	Detergent is put in the wrong compartment.	ÆIf detergent is put in the prewash compartment although prewash cycle is not selected, the product can take this detergent during rinsing or softener step. Put the detergent in the correct compartment.
	Detergent might be mixed with the softener.	ÆDo not mix the softener with detergent. Wash and clean the dispenser with hot water.

<b>Problem</b>	<b>Reason</b>	<b>Solution</b>
Laundry does not smell like the softener. (**)	Detergent is put in the wrong compartment.	ÆIf detergent is put in the prewash compartment although prewash cycle is not selected, the product can take this detergent during rinsing or softener step. Wash and clean the dispenser with hot water. Put the detergent in the correct compartment.
	Detergent might be mixed with the softener.	ÆDo not mix the softener with detergent. Wash and clean the dispenser with hot water.
Detergent residue in the detergent drawer. (**)	Detergent is put in wet drawer.	ÆDry the detergent drawer before putting in detergent.
	Detergent has become damp.	ÆKeep detergents closed in an environment free of humidity and do not expose them to excessive temperatures.
	Water pressure is low.	ÆCheck the water pressure.
	The detergent in the main wash compartment got wet while taking in the prewash water. Holes of the detergent compartment are blocked.	ÆCheck the holes and clean if they are clogged.
	There is a problem with the detergent drawer valves.	ÆCall an Authorized Service Agent.
	Detergent might be mixed with the softener.	ÆDo not mix the softener with detergent. Wash and clean the dispenser with hot water.
	Regular drum cleaning is not applied.	ÆClean the drum regularly. For this procedure, please see "4.7.2 Cleaning the loading door and the drum".
Too much foam forms inside the product. (**)	Improper detergents for the washing machine are being used.	ÆUse detergents appropriate for the washing machine.
	Excessive amount of detergent is used.	ÆUse only sufficient amount of detergent.
	Detergent was stored under improper conditions.	ÆStore detergent in a closed and dry location. Do not store in excessively hot places.
	Some meshed laundry such as tulle may foam too much because of their texture.	ÆUse smaller amounts of detergent for this type of item.
	Detergent is put in the wrong compartment.	ÆPut the detergent in the correct compartment.
	Softener is being taken early by the product.	ÆThere may be problem in the valves or in the detergent dispenser. Call an Authorized Service Agent.

Problem	Reason	Solution
Foam is overflowing from the detergent drawer.	Too much detergent is used.	Æ Mix 1 tablespoonful softener and ½ l water and pour into the main wash compartment of the detergent drawer.
		Æ Put detergent into the product suitable for the programmes and maximum loads indicated in the "4.6.2 Programme and consumption table". When you use additional chemicals (stain removers, bleaches and etc), reduce the amount of detergent.
Laundry remains wet at the end of the programme. (*)	Excessive foam might have occurred and automatic foam absorption system might have been activated due to too much detergent usage.	Æ Use recommended amount of detergent.
(*) The product does not switch to spinning step when the laundry is not evenly distributed in the drum to prevent any damage to the product and to its surrounding environment. Laundry should be rearranged and re-spun.		
(**) Regular drum cleaning is not applied. Clean the drum regularly. See 4.7.2		
	<b>CAUTION:</b> If you cannot eliminate the problem although you follow the instructions in this section, consult your dealer or an Authorized Service Agent. Never try to repair a nonfunctional product yourself.	

**Blomberg, 36-38 Caxton Way, Watford,  
Hertfordshire, WD18 8UF**

**Tel: 0800 597 8560**

**Fax: 0845 6004922**

**email: [service@blomberguk.com](mailto:service@blomberguk.com)**

**[www.blomberguk.com](http://www.blomberguk.com)**