



System Monitoring
SUNNY WEBBOX with *Bluetooth*[®] Wireless Technology
Installation Guide

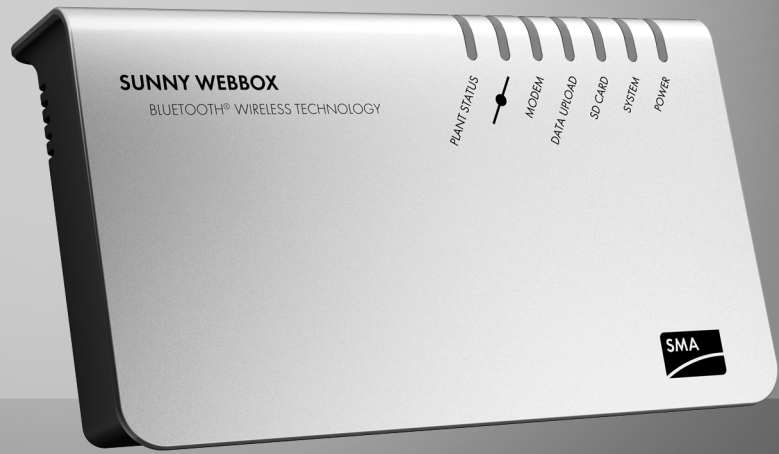

Table of Contents

1	Notes on this Manual.	7
1.1	Validity	7
1.2	Additional Information	7
1.3	Symbols Used	8
1.4	Syntax	8
2	Safety	9
2.1	Appropriate Usage	9
2.1.1	Supported products	10
2.1.2	Target Group	10
2.1.3	Certified Countries	10
2.2	Safety Instructions	11
3	Unpacking.	12
3.1	Packing List	12
3.2	Identifying the Sunny WebBox with <i>Bluetooth</i>	12
4	Device Overview	13
4.1	LED Overview	13
4.2	Connection Area Overview	14
4.3	<i>Bluetooth</i> Module Overview	15
4.3.1	<i>Bluetooth</i> Module LED Overview	15
4.4	Overview of the LEDs on the Network Connection	15

5	Mounting.	16
5.1	Mounting- / Installation Location Requirements	16
5.2	Determining the Mounting- / Installation Location for <i>Bluetooth</i> PV Plants	17
5.2.1	Information on SMA <i>Bluetooth</i>	17
5.2.2	Determining the Mounting / Installation Location	17
5.2.3	Extension of the <i>Bluetooth</i> Network Using an SMA <i>Bluetooth</i> Repeater	18
5.3	Mounting the Sunny WebBox onto the Wall	18
5.4	Mounting the Sunny WebBox on the Top-Hat Rail	19
6	Commissioning	20
6.1	Information on Commissioning	20
6.2	Configuring <i>Bluetooth</i> Settings of the Sunny WebBox	20
6.3	Connecting the Sunny WebBox directly to the Computer	22
6.4	Configuring Network Settings on the Computer	23
6.4.1	Information on Network Settings on the Computer	23
6.4.2	Windows 7, Windows Vista	23
6.4.3	Windows XP, Windows 2000	25
6.5	Logging into the Sunny WebBox	27
6.6	Configuring Sunny WebBox for the Local Network	28
6.6.1	Information on Integrating the Sunny WebBox into a Local Network	28
6.6.2	Applying Static Network Settings to the Sunny WebBox	28
6.6.3	Connecting the Sunny WebBox to the Local Network	30
7	Extended Configuration.	31
7.1	Ethernet Network	31
7.1.1	Information on Extended Network Settings	31
7.1.2	Activating / Deactivating DHCP	31
7.1.3	Proxy Server	32
7.1.4	Setting the HTTP Port	33
7.1.5	Setting the NAT Port	33

8	Service Functions	34
8.1	Updating the Firmware	34
8.1.1	Information on Firmware Update	34
8.1.2	Firmware Update via the Internet	34
8.1.3	Firmware Update via the SD Card	36
8.2	Stopping the Sunny WebBox	37
8.3	Restarting the Sunny WebBox via the user interface	37
8.4	Resetting the Sunny WebBox Using the Reset Button	38
8.5	Determining Current Settings of the Sunny WebBox via the SD Card	39
9	Maintenance and Care	40
9.1	Maintenance	40
9.2	Care	40
10	Decommissioning	41
10.1	Disassembling the Sunny WebBox	41
10.2	Packaging the Sunny WebBox	42
10.3	Disposing of the Sunny WebBox	42
11	Troubleshooting	43
11.1	General Troubleshooting for the Sunny WebBox	43
11.2	<i>Bluetooth</i> Connection	47
12	Accessories	49

13	Appendix	50
13.1	Information on the SD Card	50
13.2	Structure of the Config.xml File	50
13.3	Structure of an XML Data File	51
13.4	Information on your Web Browser	52
13.5	Setting up a Proxy Exception Rule in Internet Explorer	52
13.6	Activating IPv6 in Windows XP SP2	53
13.7	Allocating an IP Address in a Local Network	53
14	Technical Data	54
14.1	Sunny WebBox with <i>Bluetooth</i>	54
14.2	Plug-in Power Supply	55
14.2.1	CINCON, TRG30R 120.....	55
15	Contact	56

1 Notes on this Manual

This manual describes the installation and commissioning of the Sunny WebBox with *Bluetooth*. Store this guide where it will be accessible at all times. This manual does not contain any detailed information about the connected devices. Detailed information about the devices connected is provided in the manuals for the devices.

1.1 Validity

This installation guide is valid for Sunny WebBox with *Bluetooth* from hardware version A1 and from firmware version 1.1.





1.2 Additional Information

Additional information about SMA *Bluetooth* Wireless technology can be found in the download section at www.SMA.de/en.

Also read the user manual of the Sunny WebBox with *Bluetooth* which you can call up via the help button  in the user interface.

1.3 Symbols Used

The following types of safety instructions and general information appear in this document as described below:

	DANGER
<p>DANGER indicates a hazardous situation which, if not avoided, will result in death or serious injury.</p>	
	WARNING
<p>"WARNING" indicates a hazardous situation which, if not avoided, could result in death or serious injury.</p>	
	CAUTION
<p>"CAUTION" indicates a hazardous situation which, if not avoided, could result in minor or moderate injury.</p>	
	NOTICE
<p>"NOTICE" indicates a situation that can result in property damage if not avoided.</p>	
	Information
<p>Information provides tips that are valuable for the optimal installation and operation of your product.</p>	

1.4 Syntax

In this manual the term photovoltaic system is shortened to PV plant. Additionally the product name "Sunny WebBox with *Bluetooth*" is shortened to "Sunny WebBox" in the running text.

Formatting	Meaning
[Save]	Buttons are displayed in square brackets [].
"Menu1"	Menu items are displayed in quotation marks.
"Menu1 > Menu2"	Menu paths are given in quotation marks. The angle bracket > separates individual menus.
<i>Example:</i>	Examples are represented in italics.

2 Safety

2.1 Appropriate Usage

The Sunny WebBox with *Bluetooth* is a data logger that records, logs and makes available the data of a PV plant via a user interface via the integrated web server. Additionally the Sunny WebBox with *Bluetooth* can be used for remote diagnostics and the configuration of connected devices in a PV plant via the computer.

With the Sunny WebBox with *Bluetooth* all data of the connected devices can be continually recorded and evaluated. During operation the Sunny WebBox with *Bluetooth* records all values of the PV plant every 2 minutes. Values of currently opened parameter groups are updated every 20 seconds. If the connection between the Sunny WebBox with *Bluetooth* and the PV plant is broken, the Sunny WebBox with *Bluetooth* recreates the connection automatically, as soon as this is possible.

The Sunny WebBox with *Bluetooth* is integrated into the *Bluetooth* plant as a network forming device (Master device). Network forming devices are principally communication products which form the structure of the *Bluetooth* PV plant, collect, evaluate and process data.

The number of devices which the Sunny WebBox with *Bluetooth* can manage depends on the number of master devices in the *Bluetooth* network with the same NetID. If the Sunny WebBox with *Bluetooth* is the only Master in the *Bluetooth* network, the Sunny WebBox with *Bluetooth* can manage up to 50 devices. If 2 masters are present in the *Bluetooth* network (e.g. Sunny Explorer or the Sunny Beam with *Bluetooth*), a maximum of 25 devices can be managed by the Sunny WebBox with *Bluetooth*. A maximum of one Sunny WebBox with *Bluetooth* is allowed in a *Bluetooth* network with the same NetID. Additional information about SMA *Bluetooth* Wireless technology can be found in the download section at www.SMA.de/en.

The Sunny WebBox with *Bluetooth* is only to be operated using the supplied plug-in power supply and in the voltage range intended for this.

Do not use the data from Sunny WebBox with *Bluetooth* for billing purposes. Additional costs can occur through the use of the internet.

The Sunny WebBox with *Bluetooth* is only to be used with original accessories or recommended accessories approved by SMA Solar Technology AG.

Only use the Sunny WebBox with *Bluetooth* exclusively for the purposes described in the manual.

Carefully read the documentation belonging to the Sunny WebBox with *Bluetooth* before you commission the Sunny WebBox with *Bluetooth*.

Also refer to the technical data of the Sunny WebBox with *Bluetooth*.

2.1.1 Supported products

The Sunny WebBox with *Bluetooth* supports the following SMA products:

- SMA inverters with integrated *Bluetooth*:
 - From Software-Packet 2.06: SB 3000TL-20 / SB 4000TL-20 / SB 5000TL-20
 - SB 2000HF / SB 2500HF / SB 3000HF
 - STP 10000TL-10 / STP 12000TL-10 / STP 15000TL-10 / STP 17000TL-10
- SMA inverters with upgraded SMA *Bluetooth* Piggy-Back from the software version 02.00.00.R. A list of the supported inverters can be found in the SMA *Bluetooth* Piggy-Back manual.
- Sunny Matrix from Firmware-Version 2.10.00
- SMA *Bluetooth* Repeater
- Sunny SensorBox with SMA Power Injector with *Bluetooth*

2.1.2 Target Group

The Sunny WebBox with *Bluetooth* is intended for private and industrial use. When you log in to the Sunny WebBox with *Bluetooth* there are 2 user groups at your disposal, "Installer" and "User". The "Installer" user group may only be used by qualified personnel who are authorized to make changes to network parameters for the connected devices.

2.1.3 Certified Countries

The Sunny WebBox with *Bluetooth* is certified for the following countries:

Australia, Belgium, Germany, France, Greece, Great Britain, Italy, Korea, The Netherlands, Austria, Portugal, Switzerland, Spain, The Czech Republic, The United States of America

2.2 Safety Instructions

General safety instructions, in order to avoid physical damage.

- Never open the device or the plug-in power supply.
- Install the cabling in such a way that no-one can stand on or trip over it.

General information in order to avoid damage to the device.

- By touching electronic components you can cause damage to or destroy the device through electrostatic discharge (ESD). Do not touch component connections and plug contacts unnecessarily. Ground yourself before working on the device.
- With the help of the Sunny WebBox with *Bluetooth* you can change safety relevant parameters of the SMA inverters (e.g. SMA Grid Guard parameters). Incorrectly set parameters can damage or destroy the inverter. Do not alter these safety-relevant parameters without prior consultation with your electric power company operating the grid into which your plant feeds.
- The save procedure for parameters can take up to 30 seconds. Do not separate the Sunny WebBox with *Bluetooth* from the electricity supply during the save procedure. Otherwise data can be lost.

3 Unpacking

3.1 Packing List

Check the scope of delivery for completeness and for any external damage. Please contact your dealer if you find any damage or if there are parts missing.

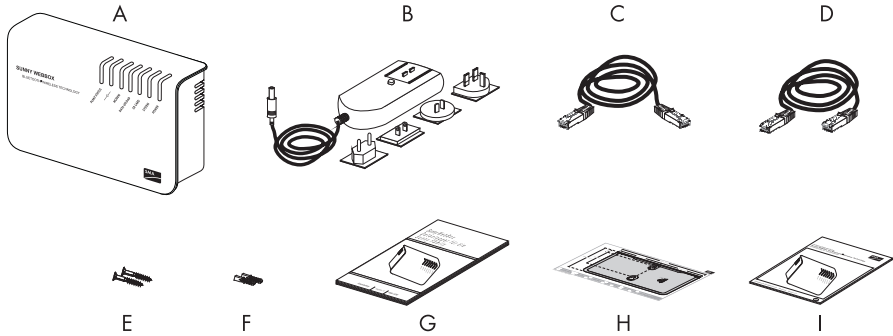

Position	Number	Description
A	1	Sunny WebBox with <i>Bluetooth</i>
B	1	Plug-in power supply and socket adapter
C	1	Network Cable (red)
D	1	Network Cable (blue)
E	2	Screws (M6)
F	2	Wall anchors (M6)
G	1	Installation Guide (The user manual of the Sunny WebBox with <i>Bluetooth</i> can be called up directly via the user interface or downloaded from www.SMA.de/en)
H	1	Drilling template
I	1	Quick guide for Sunny WebBox commissioning

3.2 Identifying the Sunny WebBox with *Bluetooth*

Type label

You can identify the Sunny WebBox using the type label. The type label can be found on the back of the enclosure.

Firmware Version

The current firmware version can be found on the status bar in the user interface of the Sunny WebBox

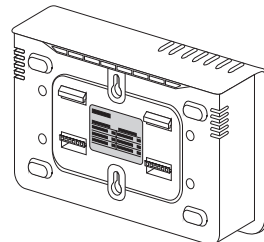

4 Device Overview

4.1 LED Overview

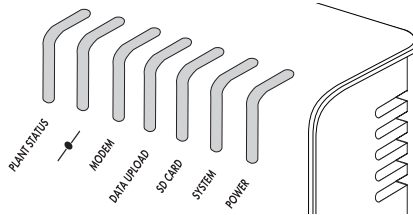

LED designation	Status	Meaning
"PLANT STATUS"	Glows green	All devices in the PV plant have the status "OK".
	Glows orange	At least 1 device in the PV plant has the "Warning" status.
	Glows red	At least 1 device in the PV plant has the "Fault" status.
	Off	There is no device available in the PV plant.
	Glows green	Default, everything is OK
	Glows orange	Login for at least 1 connected device is not OK.
	Glows red	Login for all connected device is not OK.
"MODEM"	Off	Not used
"DATA UPLOAD"	Glows green	The data transmission to the Sunny Portal or an external FTP server is active and the last upload was successful.
	Flashes green	The Sunny WebBox is currently sending data to the Sunny Portal or an external FTP server.
	Glows red	The last data transmission to the Sunny Portal or an external FTP server was not successful.
	Off	Data transmission is deactivated.

LED designation	Status	Meaning
"SD CARD"	Glows green	The SD card is inserted, writeable and the free capacity is greater than 10 % of the overall capacity.
	Flashes green	The SD card is currently being written to. The free capacity is greater than 10 % of the overall capacity.
	Glows orange	The SD card is inserted, writeable and the free capacity is less than or equal to 10 % of the overall capacity.
	Flashes orange	The SD card is currently being written to. The free capacity is less than or equal to 10 % of the overall capacity.
	Flashes red	The SD card is full or write-protected.
	Off	No SD card is inserted.
"SYSTEM"	Glows green	The Sunny WebBox is operational.
	Flashes green	The Sunny WebBox is starting.
	Flashes orange	The Sunny WebBox is performing a firmware update.
	Flashes red	A system error has occurred.
"POWER"	Glows green	The Sunny WebBox is supplied with electricity.
	Off	The Sunny WebBox is not supplied with electricity.

4.2 Connection Area Overview

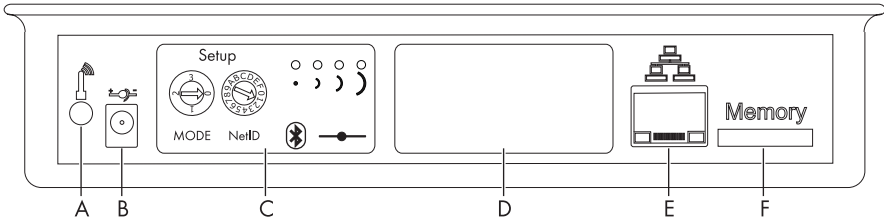

Position	Description
A	Connection for GSM antenna cable (not used)
B	Connection for the plug-in power supply
C	Module slot for the communication to the PV plant
D	Module slot (not used)
E	Network connection for 10 / 100 MBit Ethernet
F	SD card slot

4.3 Bluetooth Module Overview

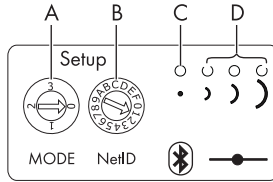

Position	Description
A	"MODE" rotary switch
B	"NetID" rotary switch
C	Bluetooth LED (blue)
D	Connection display (not used)

4.3.1 Bluetooth Module LED Overview

Status	Meaning
Bluetooth LED (blue)	
glows	Bluetooth is switched on.
off	Bluetooth is switched off.

4.4 Overview of the LEDs on the Network Connection

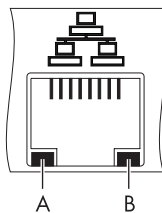

Position	LED	Status	Meaning
A	Speed	On	100 MBit connection speed
		Off	10 MBit connection speed
B	Link / Activity	On	Connection (link) established
		Flashing	The Sunny WebBox is currently transmitting or receiving data (activity).
		Off	No connection established

5 Mounting

5.1 Mounting- / Installation Location Requirements

Please note the following information on the mounting / installation location of the Sunny WebBox:

- The Sunny WebBox is only suitable for installation in enclosed spaces.
- The ambient temperature must be between $-20\text{ }^{\circ}\text{C}$ and $+65\text{ }^{\circ}\text{C}$.
- Protect the Sunny WebBox from dust, wet conditions, corrosive substances and vapors.
- Observe the minimum clearances to walls, other devices or objects as shown in the diagram in order to guarantee sufficient heat dissipation.
- Do not cover the Sunny WebBox.
- The distance from the Sunny WebBox to the inverters may not be greater than the maximum permitted distance of the corresponding plant communication type. Please note the specifications in the respective sections.
- During installation, make sure there is optimal reception for the transmission paths.
- Certain ambient conditions can reduce the connection quality and data transmission speed between *Bluetooth* devices.
 - Mount or install the *Bluetooth* device at a distance of at least 1 m from the following devices:
 - WLAN devices
 - Microwave ovens
 - Other devices that use the 2.4 GHz frequency band

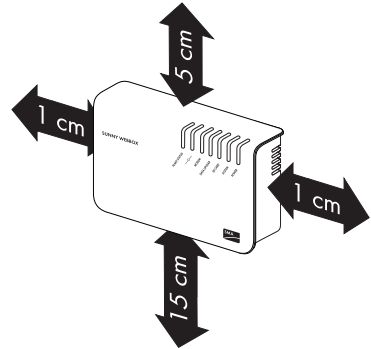

5.2 Determining the Mounting- / Installation Location for *Bluetooth* PV Plants

5.2.1 Information on SMA *Bluetooth*

Devices of your PV plant can communicate with a communication device and can be linked to other inverters via *Bluetooth*. To ensure the devices communicate with each other and are linked together, they have to be set to the same NetID. The NetID is a unique identification number of your PV plant. Thus with the NetID your PV plant is able to be distinguished from other PV plants.



Determining a NetID for your PV plant

If your plant currently does not have a NetID you must first determine a free NetID using the Sunny Explorer software or using the Sunny Beam with *Bluetooth* and then set this in the devices of your PV plant.



At the present time NetID 1 is not supported by the Sunny WebBox with *Bluetooth*.

A direct connection to an individual SMA *Bluetooth* device via NetID 1 is currently only possible with the Sunny Explorer software or the Sunny Beam with *Bluetooth*.

Change the NetID of the Sunny WebBox with *Bluetooth* to the NetID of your PV plant (NetID 2 to NetID F).

5.2.2 Determining the Mounting / Installation Location

Before you mount the Sunny WebBox, you should determine the connection quality at the mounting / installation location of the Sunny WebBox to your PV plant. The connection quality can be checked using the Sunny Explorer or the Sunny Beam with *Bluetooth*. Refer to the user manual of the relevant device. You can change the connection quality by changing the distance between the *Bluetooth* devices.

5.2.3 Extension of the *Bluetooth* Network Using an *SMA Bluetooth Repeater*

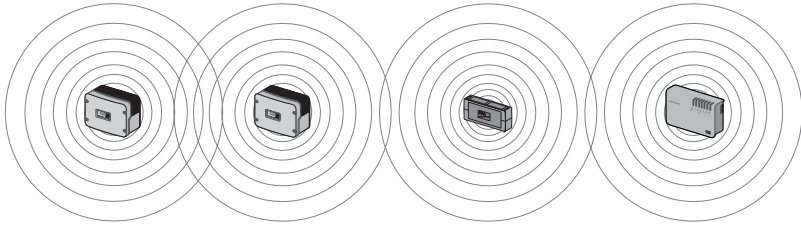

With the help of the *SMA Bluetooth Repeater* you can extend the radio range of the *Bluetooth* network. An *SMA Bluetooth Repeater* installed on the range border of the *Bluetooth* network transmits the data traffic of this network in its own radio range. This technology enables the construction of *Bluetooth* networks which cover a much larger area than would be possible using the *Sunny WebBox* alone.

5.3 Mounting the *Sunny WebBox* onto the Wall

1. Determine the mounting location taking into consideration the mounting / installation location requirements.
 2. Use the drilling template to determine the position of the *Sunny WebBox* and to mark the drilling holes with a pen.
 3. Drill holes with 6 mm diameter at the marked points and insert wall anchors.
 4. Screw in the screws and leave a 6 mm clearance between the screw head and the wall.
 5. Hang the *Sunny WebBox* onto the screws.
- The *Sunny WebBox* is now mounted on the wall.

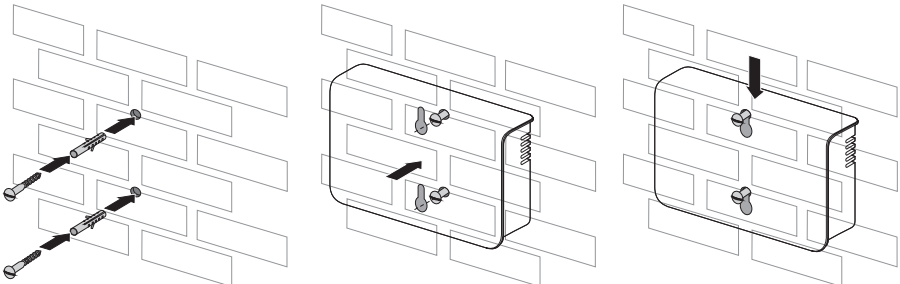

5.4 Mounting the Sunny WebBox on the Top-Hat Rail

1. Determine the mounting location taking into consideration the mounting / installation location requirements.
 2. Hook the Sunny WebBox with both lower retainers into the lower edge of the top-hat rail.
 3. Press the Sunny WebBox upwards and snap it into the upper brackets.
- The Sunny WebBox is now mounted on the top-hat rail.

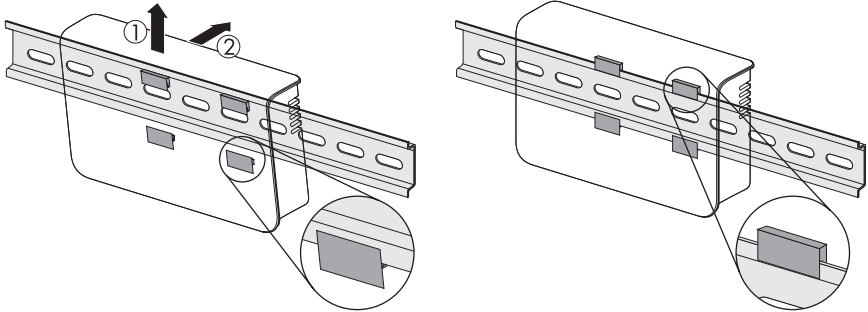

6 Commissioning

6.1 Information on Commissioning

Commission the Sunny WebBox using the Sunny WebBox Assistant

If you want to commission the Sunny WebBox for the first time then use the Sunny WebBox Assistant for the Sunny WebBox. The Sunny WebBox Assistant is a software package with which you can carry out the basic configuration of the Sunny WebBox. You can download the Sunny WebBox Assistant from the Download area at www.SMA.de/en. Additionally take into consideration the Quick guide for Sunny WebBox commissioning

Proceed then as follows:

- Configure *Bluetooth* settings of the Sunny WebBox (see page 20).
- Connect Sunny WebBox direct to the Computer (see page 22) or to the local network (see page 30).
- Start Sunny WebBox Assistant on your computer.
- Follow the instructions of the Sunny WebBox Assistant.

Commissioning the Sunny WebBox without the Sunny WebBox Assistant

If you would like to commission the Sunny WebBox without the Sunny WebBox Assistant then proceed as follows:

- Configure *Bluetooth* settings of the Sunny WebBox (see page 20).
- Connect the Sunny WebBox directly to the computer (see page 22).
- Configure network settings on the computer (see page 23).
- Configure Sunny WebBox for the local network (see page 28).

6.2 Configuring *Bluetooth* Settings of the Sunny WebBox

The *Bluetooth* settings of the Sunny WebBox are to be made via the rotary switch of the *Bluetooth* module using a screwdriver (2.5 mm).



NOTICE

Changing the NetID during operation of the Sunny WebBox

If the NetID of the Sunny WebBox is changed, a restart of the Sunny WebBox takes place. Then all devices with the same 'NetID are searched for and displayed in the plant tree.



At the present time NetID 1 is not supported by the Sunny WebBox with *Bluetooth*.

A direct connection to an individual SMA *Bluetooth* device via NetID 1 is currently only possible with the Sunny Explorer software or the Sunny Beam with *Bluetooth*.

Change the NetID of the Sunny WebBox with *Bluetooth* to the NetID of your PV plant (NetID 2 to NetID F).

1. Turn the "MODE" rotary switch to position "0". The rotary switch must always be set to position "0" (status on delivery). Other positions are not permitted and are intended for the SMA Service only.
2. Turn the arrow of the "NetID" rotary switch to the NetID of the plant. For a layout of the switch positions, see table.

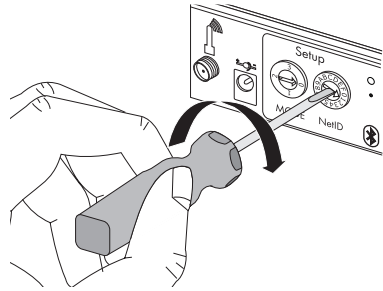

NetID	function
0	Bluetooth is switched off.
1 (delivery state)	No function
2-F	Bluetooth is switched on. The Sunny WebBox can network with all SMA Bluetooth products with the same NetID. A connection to the Sunny Beam with Bluetooth or Sunny Explorer is not possible.

The Sunny WebBox is prepared for the Bluetooth communication.

Now you can connect the Sunny WebBox to the computer with which you would like to configure the Sunny WebBox (see page 22).

6.3 Connecting the Sunny WebBox directly to the Computer

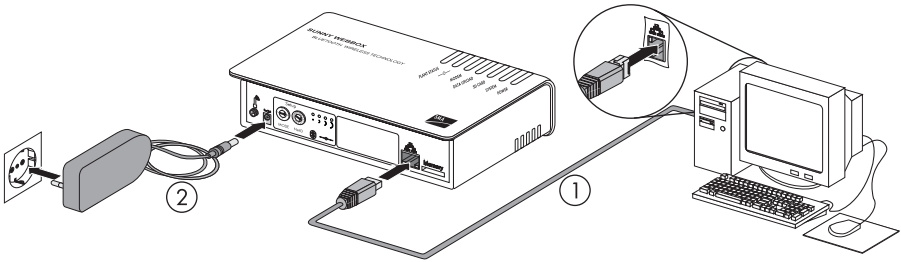

1. Connect the Sunny WebBox using the **blue** network cable (crossover cable) directly with the computer (see ①). The connection of the computer is usually indicated by the same symbol as the network connection of the Sunny WebBox. If necessary refer to the computer manual.



Recommendation on network cabling

Should the network cable supplied be too short, observe the following information when buying a longer cable:

- You require a crossover cable.
 - Unnecessarily long cables have an adverse effect on the signal quality. The maximum permitted cable length is 100 m per segment.
 - Use a high quality, at least category 5 (FTP Cat 5) or higher shielded twisted pair cable.
2. Connect the plug-in power supply to the Sunny WebBox and plug this into the socket (see ②).
 - As soon as the "SYSTEM" and "POWER" LEDs glow green, the Sunny WebBox has started up and is ready for operation. The start-up procedure can take up to 90 seconds.
 - If the "SYSTEM" or "POWER" LEDs do not glow green, please refer to section 11.1 "General Troubleshooting for the Sunny WebBox" (page 43).

Now set the network area of the computer to the network area of the Sunny WebBox (see section 6.4 "Configuring Network Settings on the Computer" (page 23)).

6.4 Configuring Network Settings on the Computer

6.4.1 Information on Network Settings on the Computer

Before you can commission the Sunny WebBox for the first time without the Sunny WebBox Assistant, you must set the computer to the network area of the Sunny WebBox in its delivered status. Read the section which relates to the operating system of your computer. If you use an operating system that is not described, refer to the manual of your operating system to find out how to set the computer IP address to 192.168.0.100 and the Subnet mask to 255.255.255.0. You can then configure the Sunny WebBox for a local network via the user interface (see page 28).



User rights in the operating system

You need the respective user rights on the computer via which you would like to commission the Sunny WebBox in order to be able to make changes to the network settings. If you have any questions, consult your system administrator.

6.4.2 Windows 7, Windows Vista

1. Start the computer.
2. In Windows select "Start"
3. Enter "ncpa.cpl" in the search field and press enter.
 - The "Network connections" window opens.
4. Double click on the LAN connection via which the Sunny WebBox is connected.
 - If Windows displays several LAN connections, there are probably several network connections installed in the computer. Ensure that you select the correct network connection, with which the computer is connected to the Sunny WebBox. If necessary, refer to the manual for your computer.
 - In the event that no LAN connection is displayed, please refer to section 11.1 "General Troubleshooting for the Sunny WebBox" (page 43).
5. Select [Properties].

- The "Local Area Connection Properties" window opens.
6. Mark "Internet protocol version 4 (TCP/IPv4)" and select [Properties].
- The "Internet Protocol (TCP/IP) Properties" window opens.

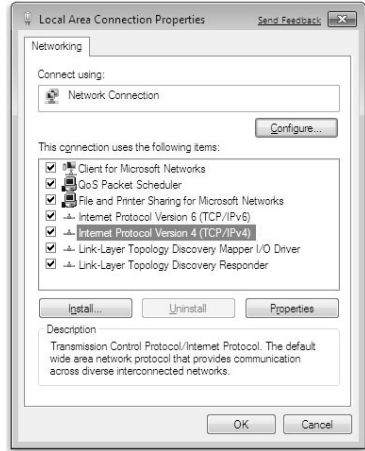

Noting existing settings

Make a note of the existing network settings in the "Internet protocol version 4 (TCP/IPv4) Properties" window in order to be able to reset the computer after configuration of the Sunny WebBox.

7. In the "Internet Protocol Version 4 (TCP/IPv4) Properties" window enter the following properties and confirm with [OK]:
- "IP address": 192.168.0.100
- "Subnet mask" 255.255.255.0
8. Select [OK] in order to save the settings and close all other windows by selection [OK].
- The Computer is set to the network settings of the Sunny WebBox.

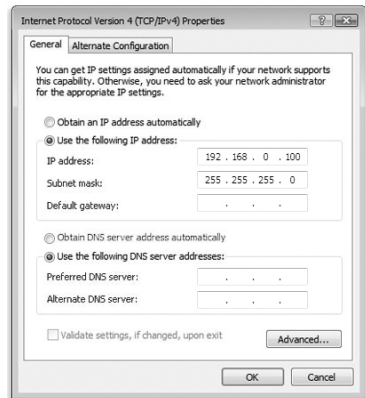

You can now log in to the user interface of the Sunny WebBox (see section 6.5 "Logging into the Sunny WebBox" (page 27)) and configure the Sunny WebBox for a local network or make further settings.

6.4.3 Windows XP, Windows 2000

1. Start the computer.
2. In Windows select "Start > Run"
3. In the "Open" field enter "ncpa.cpl" and select [OK]
 - The "Network connections" window opens.
4. Double click on the LAN connection via which the Sunny WebBox is connected.
 - If Windows displays several LAN connections, there are probably several network connections installed in the computer. Ensure that you select the correct network connection, with which the computer is connected to the Sunny WebBox. If necessary, refer to the manual for your computer.
 - In the event that no LAN connection is displayed, please refer to section 11.1 "General Troubleshooting for the Sunny WebBox" (page 43).
5. Select [Properties].
 - The "Local Area Connection Properties" window opens.
6. Mark "Internet protocol (TCP/IP)" and select [Properties].
 - The "Internet Protocol (TCP/IP) Properties" window opens.

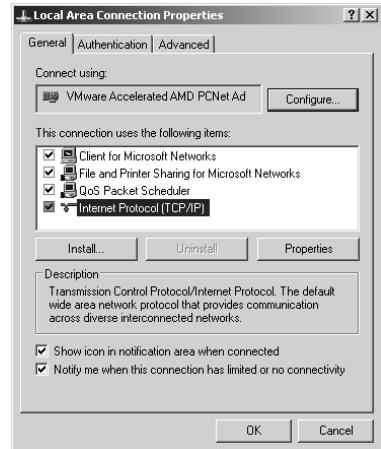

Noting existing settings

Make a note of the existing network settings in the "Internet protocol (TCP/IP) Properties" window in order to be able to reset the computer after configuration of the Sunny WebBox.

- 7. In the "Internet Protocol (TCP/IP) Properties" enter the following properties and confirm with [OK]:
"IP address": 192.168.0.100
"Subnet mask" 255.255.255.0
- 8. Select [OK] in order to save the settings and close all other windows by selection [OK].
- The Computer is set to the network settings of the Sunny WebBox.

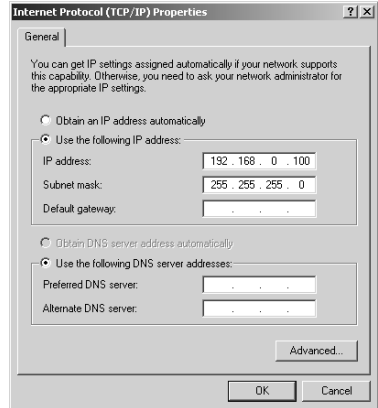

You can now log in to the user interface of the Sunny WebBox (see section 6.5 "Logging into the Sunny WebBox" (page 27)) and configure the Sunny WebBox for a local network or make further settings.

6.5 Logging into the Sunny WebBox

1. Start web browser (e.g. Internet Explorer).



Activating JavaScript in the Web browser

The Sunny WebBox user interface needs JavaScript in order to be able to correctly configure and display the functions and content of the Sunny WebBox. Activate JavaScript in the Web browser. If necessary, refer to the help section in your web browser.

2. Enter `http://192.168.0.168` into the address bar and press Enter.



- The Sunny WebBox login page appears.

- If the page does not open, please refer to section 11.1 "General Troubleshooting for the Sunny WebBox" (page 43).

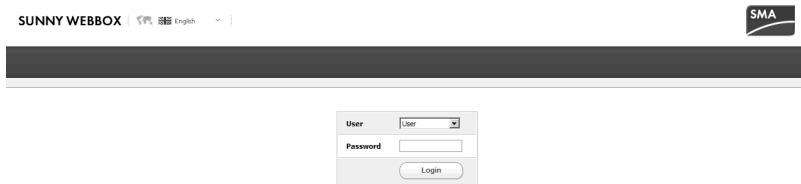

3. Log into the Sunny WebBox as user or installer. Upon delivery, the password for the User is "0000" and upon delivery the password for the Installer is "1111".



Security in the local network

Change the password of all user groups promptly in order to avoid unauthorized access.

6.6 Configuring Sunny WebBox for the Local Network

6.6.1 Information on Integrating the Sunny WebBox into a Local Network.

The next sections describe how to integrate the Sunny WebBox via static network settings into your local network with a router.

In rare cases further network settings are necessary. Further network settings are, for example, if you would like to integrate the Sunny WebBox via DHCP into your network, if there is a Proxy server in the network or if you would like to make the Sunny WebBox accessible via the internet. In this case contact your network administrator and read section 7 "Extended Configuration" (page 31).



Protecting Ethernet network from external access

Protect your Ethernet network through suitable security measures such as via a firewall and through the allocation of secure passwords (see the Sunny WebBox user manual). After the first login to the Sunny WebBox please change the passwords for each user group.

6.6.2 Applying Static Network Settings to the Sunny WebBox

1. Click on the "Settings" button in the icon bar.



2. Select the "External Communication > Ethernet" parameter group.
3. Select [Edit].

External Communication	
▼ Ethernet	
DNS server IP	<input type="text" value="0.0.0.0"/>
Gateway IP	<input type="text" value="0.0.0.0"/>
IP Address	<input type="text" value="192.168.0.168"/>
Subnet mask	<input type="text" value="255.255.252.0"/>
▶ DHCP	
▶ Nat	
▶ Proxy settings	
▶ HTTP	
<input type="button" value="Save"/> <input type="button" value="Cancel"/>	

4. In the "DNS server IP" field enter the IP address of the DNS server (Domain Name System Server). Usually, this is the IP address of the router.
5. Enter the Gateway IP address of your network into the "Gateway IP" field. Usually, this is the IP address of the router.
6. In the "IP Address" field enter the static IP address, under which the Sunny WebBox is to be reachable in the local network (see section 1.3.4 "Information on your Web Browser" (page 52)).

7. In the "Subnet mask" field, enter the subnet mask of your network. Normally you can find this information in the router manual.
8. Select [Save].
 - The Sunny WebBox saves the network settings. The save procedure can take up to 30 seconds. Do not separate the Sunny WebBox with *Bluetooth* from the electricity supply during the save procedure. The save procedure is complete when you are directed to the new IP address or the Sunny WebBox is no longer available via the web browser.



Resetting the computer to the network settings.

Reset your computer to the original network settings, in order that you can reach it via the local network when required (see section 6.4 "Configuring Network Settings on the Computer" (page 23)).

9. When the save procedure is completed, remove the plug-in power supply of the Sunny WebBox from the plug socket.
10. Remove the network cable (blue).
 - The local network settings are applied to the Sunny WebBox.

You may now connect the Sunny WebBox to the local network (see section 30).

6.6.3 Connecting the Sunny WebBox to the Local Network

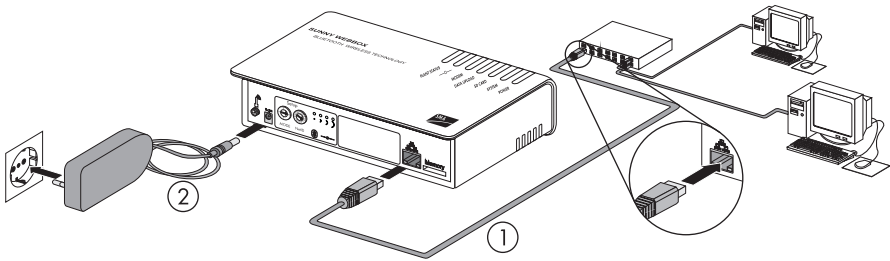

1. Connect the Sunny WebBox directly to the receiver (e.g. router, switch or hub) of the local network using the **red** network cable (patch cable) (see ①). The connection of the receiver is normally indicated by the same symbol as the Sunny WebBox network connection. If you have questions then please refer to the receiver manual.



Recommendation on network cabling

Should the network cable supplied be too short, observe the following information when buying a longer cable:

- You require a patch cable.
 - Unnecessarily long cables have an adverse effect on the signal quality. The maximum permitted cable length is 100 m per segment.
 - Use a high quality, at least category 5 (FTP Cat 5) or higher shielded twisted pair cable.
2. Connect the plug-in power supply to the Sunny WebBox and plug this into the socket (see ②).
 - ☑ As soon as the "SYSTEM" and "POWER" LEDs glow green, the Sunny WebBox has started up and is ready for operation. The start-up procedure can take up to 90 seconds.
 - If the "SYSTEM" or "POWER" LEDs do not glow green, please refer to section 11.1 "General Troubleshooting for the Sunny WebBox" (page 43).

The user interface of the Sunny WebBox is now available via the new IP address. You can now configure further settings in the Sunny WebBox. Place the Sunny WebBox at the selected mounting / installation location.

7 Extended Configuration

7.1 Ethernet Network

7.1.1 Information on Extended Network Settings



Changing extended network settings

Do not change any network settings in the network devices if you are not clear on the effects of the change. Changes to values could lead to the existing network not functioning or only partially functioning. If you have any questions please contact your network administrator.



Sunny WebBox Assistant

It is recommended to use the Sunny WebBox Assistant for the commissioning of the Sunny WebBox and for the integration into a network. You can download the Sunny WebBox Assistant on the internet from www.SMA.de/en.

You can assign static network settings to the Sunny WebBox or obtain these dynamically via a DHCP server. Additionally it is possible to use a Proxy server for the internet connection.

If you would like to make the Sunny WebBox available in the internet, to allow, for example, direct access to the Sunny WebBox via the Sunny Portal, you must configure a Port rerouting in your router. Here it may be necessary to align the HTTP port and the NAT port.

7.1.2 Activating / Deactivating DHCP

The Sunny WebBox can obtain its network settings via a DHCP server (Dynamic Host Configuration Protocol). With this during the start of the Sunny WebBox the IP address, subnet mask, gateway and DNS server are automatically obtained from the DHCP server. In order to establish the Sunny WebBox in your network, use the Sunny WebBox Assistant.

Activating DHCP

1. Select the Sunny WebBox in the plant tree and select "Settings" in the device menu.
or
Click on the "Settings" button in the icon bar.
 2. Select the "External Communication > Ethernet" parameter group.
 3. Select [Edit].
 4. Under "DHCP" select "Yes" in the "Activated" field in order to receive the network settings dynamically assigned.
 5. Select [Save].
- The Sunny WebBox obtains the network settings automatically via the DHCP server.

Deactivating DHCP

1. Select the Sunny WebBox in the plant tree and select "Settings" in the device menu.
or
Click on the "Settings" button in the icon bar.
2. Select the "External Communication > Ethernet" parameter group.
3. Select [Edit].
4. Under "DHCP" select "No" in the "Activated" field in order to assign the network settings statically (see section 6.6.2 "Applying Static Network Settings to the Sunny WebBox" (page 28)) (Status on delivery).
5. Select [Save].
6. The network settings are assigned manually.

7.1.3 Proxy Server

If there is a Proxy server in your network, enter the Proxy settings here. The Proxy settings of the Sunny WebBox are used for connection to the Sunny Portal and for firmware updates.

Using the Proxy server

1. Select the Sunny WebBox in the plant tree and select "Settings" in the device menu.
or
Click on the "Settings" button in the icon bar.
2. In the "Activated" field select "Yes" in order to use the Proxy server.
3. In the "Login" field enter the login name for the Proxy Server.
4. In the "Port" field enter the network port under which the Proxy server is available.
5. In the "Password" field enter the password for the Proxy Server.
6. Confirm the password entered in the "Confirm the password" field.
7. In the "Server" field enter the Proxy Server IP address.
8. Select [Save].
- The Proxy server will be used.

Not using the Proxy server

1. Select the Sunny WebBox in the plant tree and select "Settings" in the device menu.
or
Click on the "Settings" button in the icon bar.
2. In the "Activated" field" select "No" in order not to use the Proxy server.
3. Select [Save].
- The Proxy server will not be used.

7.1.4 Setting the HTTP Port



Adjusting the network ports

Changing the ports is only necessary in rare cases. Before adjusting the ports, contact your network administrator.

The HTTP port is the network port under which the Sunny WebBox user interface is available. The HTTP Port is set to 80 by default. Should another port be entered, this is to be explicitly specified during call up of the user interface.

Example: The Sunny WebBox IP address is 192.168.0.168 and the HTTP port was changed to 8080; thus "http://192.168.0.168:8080" must then be entered in the address bar of the web browser.

1. Select the Sunny WebBox in the plant tree and select "Settings" in the device menu.

or

Click on the "Settings" button in the icon bar.

2. Select the "External Communication > HTTP" parameter group.
 3. Select [Edit].
 4. In the "Port" field enter the desired Port. (Status upon delivery: Port 80)
 5. Select [Save].
- The HTTP port is saved.

7.1.5 Setting the NAT Port



Adjusting the network ports

Changing the ports is only necessary in rare cases. Before adjusting the ports, contact your network administrator.

During a data transfer the Sunny WebBox communicates to the Sunny Portal under which IP address and which port the Sunny WebBox is available on the internet. For this the respective port must be released by the router. If the NAT (Network Address Translation) in the router is changed, you must specify the network port that has been set in the router. The NAT Port is set to 80 by default.

1. Select the Sunny WebBox in the plant tree and select "Settings" in the device menu.

or

Click on the "Settings" button in the icon bar.

2. Select the "External Communication > Ethernet > NAT" parameter group.
 3. Select [Edit].
 4. In the "Port" field enter the desired Port.
 5. Select [Save].
- The NAT port is saved.

8 Service Functions

8.1 Updating the Firmware

8.1.1 Information on Firmware Update

You have the option of updating the Sunny WebBox firmware. The firmware update can be performed online via the internet or locally via the SD card. Existing settings of the Sunny WebBox and data from the PV plant remain available after the update procedure. In order to always keep the Sunny WebBox at the latest level, automatic firmware updates via the internet is recommended.

The update procedure is displayed via the flashing orange "SYSTEM" LED and occasionally via a red running light across all LEDs. The firmware update is complete when the "SYSTEM" LED is green. The Sunny WebBox is again available via the user interface after the update procedure. An update procedure can take up to a maximum of 20 minutes.



Effect on the function during the update procedure

The Sunny WebBox restarts during the update process. Restarting impairs the function of the Sunny WebBox. For a short time you can not access the user interface.



Never remove the plug-in power supply during the update procedure.

8.1.2 Firmware Update via the Internet

If the Sunny WebBox has internet access, you can update the Sunny WebBox via the internet automatically or manually.

Activating / Deactivating automatic firmware update

When the automatic firmware update is activated, the Sunny WebBox check 1x daily whether a new firmware update is available. If a new firmware update is available, the Sunny WebBox downloads this from the internet. The update procedure starts automatically the following night (11:00 p.m.) when the PV plant is not in operation.



Unexpected interruption of an automatically started update procedure

If an automatically started update procedure of the Sunny WebBox is interrupted (e.g. as a result of a power failure), the Sunny WebBox restarts the update procedure in the next defined time period.

1. Select the Sunny WebBox in the plant tree and select "Settings" in the device menu.
- or**
1. Click on the "Settings" button in the icon bar.
 2. Select the "Device > Update" parameter group.
 3. Click on the [Edit] button.

4. In the "Automatic update" field select "Yes" in order to activate the automatic firmware update. (Status upon delivery)

or

In the "Automatic update" field select "No" in order to deactivate the automatic firmware update.

5. Select [Save].
- The automatic firmware update is set.

Updating the Firmware Manually



NOTICE

Loss of plant data

Only perform a manual firmware update when the PV plant is not in operation (e.g. during the night). Otherwise, losses during the recording of the plant data may occur.



You can also carry out manual updates when the automatic firmware update is activated.

1. Select the Sunny WebBox in the plant tree and select "Settings" in the device menu.
- or**
- Click on the "Settings" button in the icon bar.
2. Select the "Device > Update" parameter group.
 3. Select [Edit].
 4. In the "Check for update and install it" field select "Execute".
 5. Select [Save].
- The Sunny WebBox checks whether a new firmware update is available. If a new firmware update is available, the Sunny WebBox downloads this from the internet and starts the update procedure.

8.1.3 Firmware Update via the SD Card

 **NOTICE**
Loss of plant data

Only perform a manual firmware update when the PV plant is not in operation (e.g. during the night). Otherwise, losses during the recording of the plant data may occur.

 **NOTICE**
Loss of data on the SD card

Do not remove the SD card whilst the "SD Card" LED is flashing green or orange. This can damage the file system of the SD card and lead to data loss. Depending on the amount of data, the saving process can take some time.

Please take note of information on the SD card (see section 13.1 "Information on the SD Card" (page 50)).

1. With the help of the computer create a folder on the SD card with the name "UPDATE".
2. Copy the update file (*.up2) in the folder created on the SD card.
3. Remove the plug-in power supply of the Sunny WebBox from the plug socket.

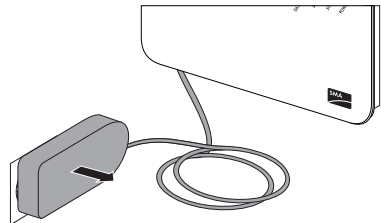

4. Insert the prepared SD card into the Sunny WebBox SD card slot.

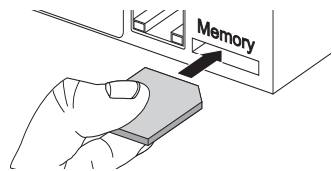

5. Insert the plug-in power supply of the Sunny WebBox into the socket.

- The update procedure starts.

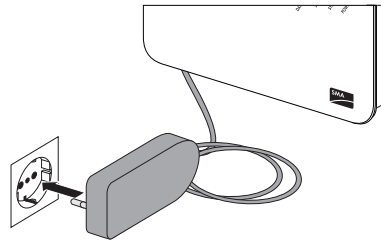

8.2 Stopping the Sunny WebBox



NOTICE

Loss of plant data

Only remove the plug-in power supply when the PV plant is not in operation (e.g. during the night). Otherwise, losses during the recording of the plant data may occur.



NOTICE

Loss of data on the SD card

Do not remove the Sunny WebBox from the electricity grid whilst the SD CARD LED is flashing green or orange. This can damage the file system of the SD card and lead to data loss. Depending on the amount of data, the saving process can take some time.

1. Remove the plug-in power supply of the Sunny WebBox from the plug socket.
- The Sunny WebBox has been stopped.

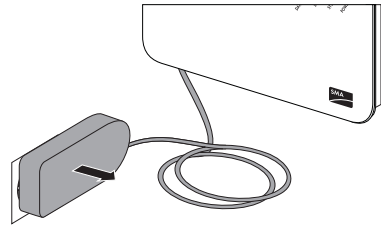

8.3 Restarting the Sunny WebBox via the user interface

1. Select the Sunny WebBox in the plant tree and select "Settings" in the device menu.
or
Click on the "Settings" button in the icon bar.
 2. Select the "Device > System" parameter group.
 3. Select [Edit].
 4. In the "Initiate device restart" field select "Execute".
 5. Select [Save].
- The Sunny WebBox is restarted. The restart was successful if the "SYSTEM" and "POWER" LEDs light up again. The start-up procedure can take up to 90 seconds.
- IF the "SYSTEM" or "POWER" LEDs do not glow green, please refer to section 11.1 "General Troubleshooting for the Sunny WebBox" (page 43).

8.4 Resetting the Sunny WebBox Using the Reset Button

You can reset the Sunny WebBox via a small hole in the rear side of the Sunny WebBox with the reset button hidden behind this. For this the Sunny WebBox must be supplied with electricity.



Data backup

Before you reset the Sunny WebBox, take note when necessary of all settings such as network or portal settings. In addition save the PV plant data for example via the SD card or the FTP download, in order to avoid data losses.

Depending on how long you press the Reset button, the Sunny WebBox performs the actions listed in the following table.

Duration	Action
1 - 5 seconds	Reset the passwords to the delivered status. All other settings and PV plant data will be saved.
5 - 15 seconds	Reset the network settings to the delivered status. All other settings and PV plant data will be saved.
15 - 30 seconds	Resets all settings (event memory, network settings, modem settings, portal settings and passwords) of the Sunny WebBox back to the delivered status. PV plant data will be fully deleted.

1. Use a sharp object to activate the hidden reset button through the hole.
 The Sunny WebBox is reset.

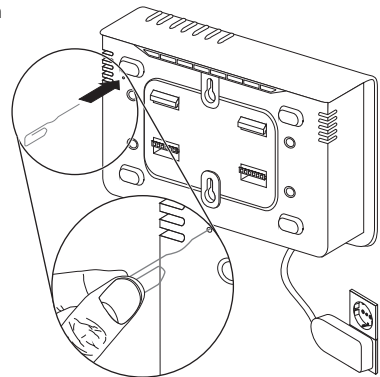

8.5 Determining Current Settings of the Sunny WebBox via the SD Card

With the following steps you can determine the current settings and the current firmware of the Sunny WebBox when you do not have access to the user interface.

Please take note of information on the SD card (see section 13.1 "Information on the SD Card" (page 50)).

1. Insert the SD card into the Sunny WebBox SD card slot.

- The Sunny WebBox creates a folder with the name "WEBBOX_[Serial number]" on the SD card and saves the "config.xml" file there. The writing process is complete when the "SD CARD" LED is permanently lit. *Example: WEBBOX_0155000123\config.xml*

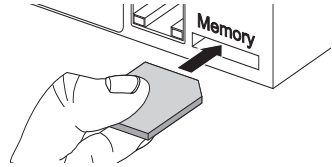

2. When the "SD CARD" LED is permanently lit, remove the SD card from the Sunny WebBox SD card slot.
 3. Read off the SD card using a computer with an SD card reader.
 4. Open the "config.xml" file in the WebBox_[Serial number] folder with a text editor or a web browser.
- Extract the network settings of the Sunny WebBox (see section 13.2 "Structure of the Config.xml File" (page 50)).

9 Maintenance and Care

9.1 Maintenance

Conduct regular visual inspections of the Sunny WebBox to check for external damages or soiling.

9.2 Care

**NOTICE****Damage to the device due to ingress of liquids.**

- The Sunny WebBox is not waterproof. Protect the Sunny WebBox from wet conditions.
- When cleaning the device, only use a lightly damp cloth in order to prevent water from entering the device. If there is a considerable amount of dirt, you can also use a mild, non-abrasive, non-corrosive cleaning agent.

10 Decommissioning

10.1 Disassembling the Sunny WebBox

1. Stop the Sunny WebBox as described in section 8.2 "Stopping the Sunny WebBox" (page 37).
2. Remove the DC plug of the plug-in power supply from the enclosure.
3. Remove the Sunny WebBox network cable.
4. Depending on the mounting type dismount the Sunny WebBox as follows:

Wall mounting

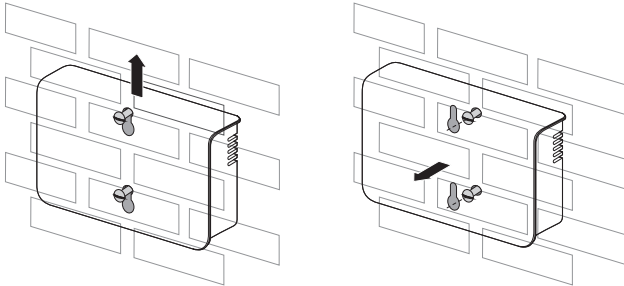

Top-hat rail mounting

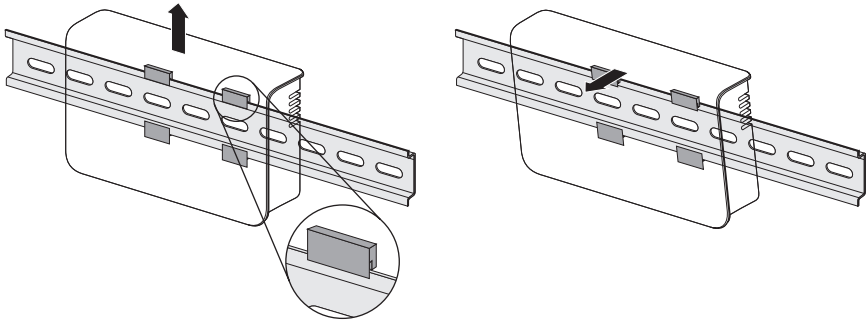

- The Sunny WebBox has been dismantled.

10.2 Packaging the Sunny WebBox

When returning the device to us, use transport-secure packaging. If possible, the original packaging.

10.3 Disposing of the Sunny WebBox

Dispose of the Sunny WebBox at the end of its service life in accordance with the disposal regulations for electronic scrap which apply at the installation site at that time. Alternatively, send it back to SMA with shipping paid by sender, and labeled "ZUR ENTSORGUNG" ("FOR DISPOSAL").

11 Troubleshooting

11.1 General Troubleshooting for the Sunny WebBox

No.	Problem	Cause	Rectification
1	The Sunny WebBox is not available via the user interface.	The Sunny WebBox is not connected to the network or to the power supply.	<ul style="list-style-type: none"> • Connect the Sunny WebBox with the network cable directly to the computer or the local network and supply the Sunny WebBox with power (see page 20).
	or The Sunny WebBox can not be found via the Sunny WebBox Assistant.	Incorrect network settings of the network components.	<ul style="list-style-type: none"> • Use the Sunny WebBox Assistant for commissioning. • Check the network settings of the computer with which you wish to access the Sunny WebBox. Align the network settings when necessary. • Carry out a reset of the Sunny WebBox (see page 38) and repeat the commissioning. • Check the network settings for the individual network components (e.g., router, Proxy server, etc.). Align the network settings when necessary. • Please contact your network administrator.
		A Firewall is blocking the connection.	<ul style="list-style-type: none"> • Deactivate the computer firewall or enable the necessary connection.
		Defective or damaged network components, network cable or plug connections.	<ul style="list-style-type: none"> • Replace the defective or damaged parts in the network. • Please contact your network administrator.

No.	Problem	Cause	Rectification
1	The Sunny WebBox is not available via the user interface. or The Sunny WebBox can not be found via the Sunny WebBox Assistant.	The web browser is incorrectly configured.	<ul style="list-style-type: none"> • If there is a Proxy server in your network, you must enter an exception for the Proxy server in your web browser (see section 13.4 "Information on your Web Browser" (page 52)).
		There is no internet connection.	<ul style="list-style-type: none"> • Reinstall the internet access. If necessary, please contact your internet service provider.
		The Sunny WebBox has not been correctly started.	<ul style="list-style-type: none"> • Remove the Sunny WebBox plug-in power supply from the plug socket and plug it back in after a short time in order to restart the Sunny WebBox. Note that this can lead to loss of collected plant data.
		IPv6 is not supported by the Proxy server.	<ul style="list-style-type: none"> • Use a Proxy server that supports IPv6.
2	The "SYSTEM" LED is flashing red	A system error has occurred.	<ul style="list-style-type: none"> • Remove the Sunny WebBox plug-in power supply from the plug socket and plug it back in after a short time in order to restart the Sunny WebBox. Note that this can lead to loss of collected plant data. • Contact the SMA Serviceline.
3	The "POWER" LED is off.	The Sunny WebBox is not supplied with electricity.	<ul style="list-style-type: none"> • Check the power supply of the plug socket and rectify any faults.

No.	Problem	Cause	Rectification
4	Sunny WebBox does not send any data to the Sunny Portal or the external FTP server (the "DATA UPLOAD" LED is red)	The data transfer is incorrectly configured.	<ul style="list-style-type: none"> • Check the settings of Sunny Portal or FTP Push (see the Sunny WebBox user manual). • Perform a connection test. • You must be registered for data transfer to Sunny Portal. Register your Sunny WebBox in the Sunny Portal (see the Sunny WebBox user manual).
	The connection test to Sunny Portal or to the external FTP server was not successful.	There is a fault in the network.	<ul style="list-style-type: none"> • Check the network settings of the individual network components (e.g., router, Sunny WebBox, Computer) and adjust if necessary. • Check the network components for defects or damage. Replace defective or damaged parts in the network. • Perform a connection test.
5	Sunny Portal registration was not successful.	Invalid data	<ul style="list-style-type: none"> • Perform a connection test (see the Sunny Webbox user manual).
6	After an FTP download, the Internet Explorer shows old Sunny WebBox data.	The cache properties of Internet Explorer shows old data.	<ul style="list-style-type: none"> • Use an FTP client in order to load the plant data from the internal FTP server of the Sunny WebBox.
7	The "SD CARD" LED glows red.	The SD card is full.	<ul style="list-style-type: none"> • Replace the SD card or format the SD card in FAT 32 format.
		The SD card is write-protected.	<ul style="list-style-type: none"> • Remove the write protection of the SD card.

No.	Problem	Cause	Rectification
8	After a Sunny WebBox is replaced, two plants appear in the Sunny Portal with the same name.	Double Sunny Portal registration	<p>The Sunny WebBox supplied as a replacement device logs into the Sunny Portal with a new plant ID. Sunny Portal creates a new plant for this plant identifier, even if you gave the plant the same name.</p> <ul style="list-style-type: none"> • Assign the plant ID of the old plant to the replacement device (see the Sunny WebBox user manual). • In the replacement device enter the e-mail address of a user who has administrator rights in Sunny Portal for the plant. • In Sunny Portal, delete the new plant the replacement device created.
9	Parameters can not be processed	You do not possess the necessary parameter rights.	<ul style="list-style-type: none"> • Change the user group.
		You have an inverter with upgraded SMA <i>Bluetooth</i> Piggy-Back with a software version lower than 02.00.00.R.	<p>The configuration of parameters and the graphical presentation of monthly and annual energy values are not supported.</p> <ul style="list-style-type: none"> • Perform an update of the <i>Bluetooth</i> Piggy-Back with the help of Sunny Explorer.
10	LAN connection can not be displayed in Windows.	The network card driver (Ethernet card) is not installed or the network card is defective.	<ul style="list-style-type: none"> • Check the installation of the network adaptor in the device manager and re-install the driver when necessary or replace the faulty network card with a new one.
11	Fault in the user interface display	JavaScript is not activated.	<ul style="list-style-type: none"> • Activate JavaScript in the Web browser

11.2 Bluetooth Connection

No.	Problem	Cause	Rectification
1	No <i>Bluetooth</i> devices are displayed in the Sunny WebBox.	An incorrect NetID is set.	<ul style="list-style-type: none"> Set the NetID of the PV plant (see section 6.2 "Configuring Bluetooth Settings of the Sunny WebBox" (page 20)) and repeat the commissioning.
		The connection to the <i>Bluetooth</i> plant is too weak.	<ul style="list-style-type: none"> Shorten the distance to the devices or use an <i>SMA Bluetooth Repeater</i> in order to extend the radio range. Repeat the commissioning (see section 20).
		There are already 4 masters connected to the <i>Bluetooth</i> plant.	<ul style="list-style-type: none"> Remove a Master and repeat the commissioning (see page 20).
		There are already 2 nodes connected to the device through which you want to connect to the <i>Bluetooth</i> plant.	<ul style="list-style-type: none"> Change the position of the Sunny WebBox in order to create a connection via another device in the plant or remove a Master from the plant. Further information on <i>SMA Bluetooth</i> can be found in the download section at www.SMA.de/en.
2	Inverter is not accessible.	The <i>Bluetooth</i> connection was interrupted.	<ul style="list-style-type: none"> Wait until the Sunny WebBox has automatically recreated the connection.

No.	Problem	Cause	Rectification
2	Inverter is not accessible.	Parameters for the <i>Bluetooth</i> communication were changed.	When setting parameters that regulate the <i>Bluetooth</i> connection (e.g. parameters for the transmitting power and country parameters), the communication via <i>Bluetooth</i> is interrupted for some time because the inverters are carrying out a reboot of the communication interface. This does not affect inverters with upgraded SMA <i>Bluetooth</i> Piggy-Back. <ul style="list-style-type: none"> • Wait until the inverter has completed a restart. The inverter is then accessible again.
		Inverter with upgraded SMA <i>Bluetooth</i> Piggy-Back is in night mode.	<ul style="list-style-type: none"> • Wait until the inverter is again working in normal operation. The inverter is then accessible again.
		The inverter has not been set to the same NetID and commissioned.	<ul style="list-style-type: none"> • The inverter must be set to the NetID of your PV plant and commissioned. Contact your installer.
3	An unknown inverter is displayed.	The set NetID is already assigned via an unknown <i>Bluetooth</i> PV plant.	<ul style="list-style-type: none"> • You must assign the PV plant with a free NetID. Contact your installer.
4	An inverter is displayed as unknown device in the plant tree.	The inverter with integrated <i>Bluetooth</i> has an old software packet (only for inverters SB 3000TL-20, SB 4000TL-20, SB 5000TL-20).	<ul style="list-style-type: none"> • Update the software packet version of your inverter to a version higher than 2.0.

12 Accessories

SMA Bluetooth Repeater

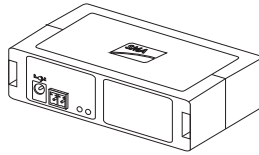

SMA order number	Description
BTREP	SMA Bluetooth repeater for increasing the range of SMA Bluetooth products for use indoors.

SD Cards

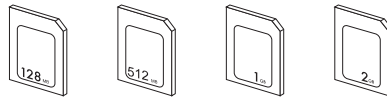

SMA order number	Description
SD-Card 128 MB	128 MB Secure Digital Memory Card for Sunny WebBox, I-Grade
SD-Card 512 MB	512 MB Secure Digital Memory Card for Sunny WebBox, I-Grade
SD Card 1GB	1 GB Secure Digital Memory Card for Sunny WebBox, I-Grade
SD Card 2 GB	2 GB Secure Digital Memory Card for Sunny WebBox, I-Grade

13 Appendix

13.1 Information on the SD Card

To ensure that the SD card is functioning properly, use SD cards available from SMA. Compatibility with all SD cards available on the market cannot be guaranteed. The Sunny WebBox does not support SD cards with storage capacities of over 2 GB or SDHC cards.

Only use SD cards which have been formatted with the FAT32 file system. If necessary reformat the SD card using the computer.

The Sunny WebBox converts the SD card's file system to TFAT in order to increase data security. If you wish to clear the SD card, you must format the SD card on the computer with the FAT32 file system.

13.2 Structure of the Config.xml File

The "config.xml" configuration file contains information on the Sunny WebBox network settings, the firmware version and further settings.

Example:

```
<?xml version='1.0' encoding='utf-8'?>
<WebBox>
  <Settings>
    <add key='Version' value='1.0.40.B' />
    <add key='Plant-ID' value='' />
    <add key='User-ID' value='Max.Mustermann@SMA.de' />
    <add key='DHCP' value='False' />
    <add key='IP-Address' value='192.168.0.168' />
    <add key='SubNetMask' value='255.255.255.0' />
    <add key='Gateway' value='192.168.0.1' />
    <add key='DNS-Server' value='192.168.0.1' />
    <add key='NAT-Port' value='80' />
    <add key='Webserver-Port' value='80' />
    <add key='Webservice-Port' value='80' />
  </Settings>
</WebBox>
```

Setting	Meaning
Version	The current firmware version of the Sunny WebBox
Plant ID	Plant ID for Sunny Portal
User ID	User ID for Sunny Portal

Setting	Meaning
DHCP	Displays whether the network settings are acquired via DHCP.
IP address	The current IP address of the Sunny WebBox
SubNetMask	The current Subnet mask of the Sunny WebBox
Gateway	The set Gateway IP address
DNS Server	The set DNS server IP address
NAT Port	The currently set NAT port
Web server port	The currently set port of the web server
Webservice port	The set port of the webservice

13.3 Structure of an XML Data File

Setting	Meaning
Info	Information
Create	Date of generation
Culture	Language
UtcOffset	Offset in minutes to UTC
MeanPublic	Data of the mean values

Example:

```
<?xml version="1.0" encoding="utf-8"?>
<WebBox>
  <Info>
    <Created>2010-02-10T01:37:04</Created>
    <Culture>de</Culture>
  </Info>
  <MeanPublic>
    <Key>Sunny WebBox:155000234:Metering.TotWhOut</Key>
    <Mean>761.858</Mean>
    <Base>1</Base>
    <Period>300</Period>
    <Timestamp>2010-02-09T10:55:52</Timestamp>
  </MeanPublic>
  <MeanPublic>
    (...)
  </MeanPublic>
</WebBox>
```

Setting	Meaning
Info	Information
Create	Date of generation
Culture	Language
UtcOffset	Offset in minutes to UTC
MeanPublic	Data of the mean values

Setting	Meaning
CurrentPublic	Data of the spot values
Key	Name of the element made up of device name, serial number of the device and the parameter name Individual values are separated by a colon. <i>Example: <Key>Sunny WebBox:155000234:Metering.TotWhOut</Key></i>
Min	Smallest value in measurement interval / merging
Max	Largest value in measurement interval / merging
Mean	Average value in measurement interval / merging
Base	Quantity of the spot values in interval / quantity of the merged values
Period	Length of the measurement interval in seconds
TimeStamp	Time stamp, at which the average was calculated

13.4 Information on your Web Browser

In order to be able to call up the Sunny WebBox user interface, you need a current web browser. You can use the standard settings of your web browsers.

Ensure that

- JavaScript is activated.
- If a Proxy server is active in your network, you must set up a Proxy exception rule in your browser (see page 52).

13.5 Setting up a Proxy Exception Rule in Internet Explorer

1. Start Internet Explorer.
 2. In Internet Explorer, select "Tools > Internet Options".
 3. The "Internet Options" window opens.
 4. Select the "Connections" tab, then click [Settings].
 5. Select [Advanced].
 6. In the "For addresses that start as follows, do not use a Proxy server:" field, enter the address 192.168.*.
 7. Confirm entry with [OK] and close all further windows by selecting [OK] in each.
- The Proxy exception rule is set up.

13.6 Activating IPv6 in Windows XP SP2

In order to be able to locate the Sunny WebBox with the Sunny WebBox Assistant IPv6 is required. IPv6 stands for Internet Protocol Version 6 and specifies the procedures that are necessary for data transfer via a packet-switching data network.

IPv6 is the successor to IPv4, which is still predominantly found in use in the internet. IPv6 is already activated in Windows Vista, Windows 7, MacOS and Linux. IPv6 has to be activated in Windows XP SP2.

In order to activate IPv6 manually, proceed as follows:

1. In Windows select "Start > Run"
2. In the "Open" field enter "ncpa.cpl" and select [OK]
 - The "Network connections" window opens.
3. Double click on the LAN connection via which the Sunny WebBox is connected.
 - If Windows displays several LAN connections, there are probably several network connections installed in the computer. Ensure that you select the correct network connection, with which the computer is connected to the Sunny WebBox. If necessary, refer to the manual for your computer.
 - In the event that no LAN connection is displayed, please refer to section 11.1 "General Troubleshooting for the Sunny WebBox" (page 43).
4. Select "Properties".
 - The "Local Area Connection Properties" window opens.
5. Activate "Microsoft TCP/IP Version 6"
6. Select [OK].
 - IPv6 is activated.

13.7 Allocating an IP Address in a Local Network

You select a static IP address (Internet Protocol). Use the address range which is available to your router. In most cases the address range of the router lies between 192.168.0.1. and 192.168.255.254. If necessary refer to the manual of your router.

Please note during the allocation of the IP address that the first three address parts of the IP address must be identical for all participants of the same network. Additionally you may not allocate the same IP address twice.

Example:

Router:	192.168.0.1
Computer 1	192.168.0.2
Computer 2	192.168.0.3
Sunny WebBox	192.168.0.168

14 Technical Data

14.1 Sunny WebBox with *Bluetooth*

Mechanical data

Width x height x depth	255 mm x 130 mm x 57 mm
Weight	750 g

Power supply

Typical power consumption	4 W
Maximum power consumption	12 W

Ambient conditions:

Ambient temperature	-20 °C ... +65 °C
Relative humidity	5 % ... 95 %, non condensing
Protection rating *	IP20

* Protection rating according to DIN EN 60529

Communication

Sunny Boys, Sunny Mini Centrals*, Windy Boys with SMA <i>Bluetooth</i> interface	<i>Bluetooth</i>
Computer	10 / 100 Mbit Ethernet
Maximum number of SMA <i>Bluetooth</i> devices with 1 Master	50
Maximum number of SMA <i>Bluetooth</i> devices with 2 Masters	25
Maximum <i>Bluetooth</i> free-field communication range	100 m
Max. communication range of Ethernet per segment	100 m

* Apart from the USA

Other

User interface language	German, English, French, Italian, Spanish, Greek, Korean, Portuguese, Czech, Dutch
Internal circular buffer	12.5 MB
Additional memory via SD memory cards*	128 MB / 512 MB / 1 GB / 2 GB

* optional

14.2 Plug-in Power Supply

14.2.1 CINCON, TRG30R 120

Mechanical data

Width x height x depth	107.8 mm x 57.5 mm x 33.5 mm
Weight	300 g

Power supply

Voltage	100 V - 240 V AC, 50 / 60 Hz
Nominal current	0.8 A

15 Contact

If you have technical problems concerning our products, contact the SMA Serviceline. We require the following information in order to provide you with the necessary assistance:

- The current firmware version of the Sunny WebBox
- Serial number and hardware version of the Sunny WebBox.
- Type of communication interface between Sunny WebBox and the inverters.
- Type and serial numbers of the inverters connected to the plant.

SMA Solar Technology AG

Sonnenallee 1

34266 Niestetal, Germany

www.SMA.de

SMA Serviceline

Inverters: +49 561 9522 1499

Communication: +49 561 9522 2499

Fax: +49 561 9522 4699

E-Mail: Serviceline@SMA.de

The information contained in this document is the property of SMA Solar Technology AG. Publishing its content, either partially or in full, requires the written permission of SMA Solar Technology AG. Any internal company copying of the document for the purposes of evaluating the product or its correct implementation is allowed and does not require permission.

Exclusion of liability

The general terms and conditions of delivery of SMA Solar Technology AG shall apply.

The content of these documents is continually checked and amended, where necessary. However, discrepancies cannot be excluded. No guarantee is made for the completeness of these documents. The latest version is available online at www.SMA.de or from the usual sales channels.

Guarantee or liability claims for damages of any kind are excluded if they are caused by one or more of the following:

- Damages during transportation
- Improper or inappropriate use of the product
- Operating the product in an unintended environment
- Operating the product whilst ignoring relevant, statutory safety regulations in the deployment location
- Ignoring safety warnings and instructions contained in all documents relevant to the product
- Operating the product under incorrect safety or protection conditions
- Altering the product or supplied software without authority
- The product malfunctions due to operating attached or neighboring devices beyond statutory limit values
- In case of unforeseen calamity or force majeure

The use of supplied software produced by SMA Solar Technology AG is subject to the following conditions:

- SMA Solar Technology AG rejects any liability for direct or indirect damages arising from the use of software developed by SMA Solar Technology AG. This also applies to the provision or non-provision of support activities.
- Supplied software not developed by SMA Solar Technology AG is subject to the respective licensing and liability agreements of the manufacturer.

SMA Factory Warranty

The current guarantee conditions come enclosed with your device. These are also available online at www.SMA.de and can be downloaded or are available on paper from the usual sales channels if required.

Trademarks

All trademarks are recognized even if these are not marked separately. Missing designations do not mean that a product or brand is not a registered trademark.

The *Bluetooth*[®] word mark and logos are registered trademarks owned by Bluetooth SIG, Inc. and any use of such marks by SMA Solar Technology AG is under license.

SMA Solar Technology AG

Sonnenallee 1

34266 Niestetal

Germany

Tel. +49 561 9522-0

Fax +49 561 9522-100

www.SMA.de

E-Mail: info@SMA.de

© 2004 to 2010 SMA Solar Technology AG. All rights reserved

SMA Solar Technology AG

www.SMA.de

