

# CyberPower™



## **User Manual for CPS1100AVR with USB / Serial Interface and PowerPanel Plus™ Software**

**ADDITIONAL INSTALLATION TIPS CAN BE FOUND AT:  
[www.cyberpowersystems.com/faqs.htm](http://www.cyberpowersystems.com/faqs.htm)**

**TABLE OF CONTENTS**

Determining Power Requirements---1	Battery Replacement-----6
Description-----1	LED Indicators-----7
Hardware Installation Guide----- 2	Trouble Shooting Guide-----8
Software Installation Guide-----2	Specifications-----8
Software User Manual-----4	Warranty-----9

Thank you for purchasing a CyberPower Systems Product. To enjoy all the features and benefits of this Uninterruptible Power System (UPS), please read and follow all installation and operation instructions completely. This UPS is designed to provide guaranteed power protection for connected electronic equipment. The accompanying PowerPanel Plus™ software saves data, closes open applications and automatically shuts down your computer system in an intelligent and orderly manner.

---

**IMPORTANT SAFETY INSTRUCTIONS**

**(SAVE THESE INSTRUCTIONS)**

This manual contains important safety instructions. Please read and follow all instructions carefully during installation and operation of unit. Read this manual thoroughly before attempting to install or operate.

**CAUTION!** To prevent the risk of fire or electric shock, install in a temperature and humidity controlled indoor area, free of conductive contaminants. (Please see specifications for acceptable temperature and humidity range).

**CAUTION!** To reduce the risk of electric shock, do not remove the cover secured by star shaped screws. No user serviceable parts are inside except for the battery. Refer servicing to qualified personnel.

**CAUTION!** The battery can energize hazardous live parts inside even when the AC input power is disconnected.

**CAUTION!** UPS must be connected to an AC power outlet with fuse or circuit breaker protection. Do not plug into an outlet that is not grounded. If you need to de-energize this equipment, turn off and unplug the unit.

**CAUTION!** To avoid electrical shock, turn off the unit and unplug it from the AC power source before servicing the battery or installing a computer component.

**DO NOT USE FOR MEDICAL OR LIFE SUPPORT EQUIPMENT!** CyberPower Systems does not sell products for life support or medical applications or for use in any circumstance that would affect operation or safety of any medical for life support or medical applications or patient care.

**DO NOT USE WITH OR NEAR AQUARIUMS!** To reduce the risk of fire, do not use with or near aquariums. Condensation from the aquarium can cause the unit to short out.

### **HOW TO DETERMINE THE POWER REQUIREMENTS OF YOUR EQUIPMENT**

1. Make sure that the total Volt-Amp (VA) requirements of your computer, monitor and peripheral equipment does not exceed 1100VA.
2. Insure that the equipment plugged into the three battery power-supplied outlets does not exceed the UPS unit's rated capacity (1100VA/660W for CPS1100AVR). If rated unit capacities are exceeded, an overload condition may occur and cause the UPS unit to shut down or the circuit breaker to trip.
3. If the power requirements of your equipment are listed in units other than Volt-Amps (VA), convert Watts (W) or Amps (A) into VA by doing the calculations below. Note: The below equation only calculates the maximum amount of VA that the equipment can use, not what is typically used by the equipment at any one time. Users should expect usage requirements to be approximately 60% of below value.

### **TO ESTIMATE POWER REQUIREMENTS:**

$$\underline{\hspace{2cm}} \text{ Watts (W)} \times 2.0 = \underline{\hspace{2cm}} \text{ VA or } \underline{\hspace{2cm}} \text{ Amps (A)} \times 120 = \underline{\hspace{2cm}} \text{ VA}$$

Add the totals up for all pieces of equipment and multiply this total by .6 to calculate actual requirements There are many factors that can affect the amount of power that your computer system will require. The total load that you will be placing on the battery-powered outlets should not exceed 80% of the unit's capacity.

---

### **INSPECTION**

The box should contain the following:

- (1) PowerPanel Plus™ software (floppy disk); (1) serial interface cable (DB-9); (1) serial to USB adapter cable; (1) telephone communication cable; (1) user manual; (1) warranty registration card; (1) UPS unit.
- 

### **DESCRIPTION**

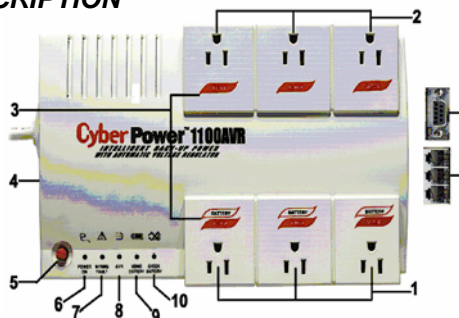

#### **1. Battery Backup and Surge Protection Outlets**

Provides three battery-supplied outlets with Automatic Voltage Regulation for consistent output power to connected equipment.

#### **2. "Always-On" Surge Protection Outlets**

Provides three surge-protected outlets to protect connected equipment against surges and spikes.

#### **3. All outlets Designed for AC Adapters**

Allows six AC power adapter blocks to be plugged into the UPS without making adjacent outlets inaccessible.

#### **4. Resettable Circuit Breaker**

Located on the side of the UPS, the circuit breaker provides circuit overload and fault protection. Under normal operating conditions, the circuit breaker is depressed.

#### **5. Power Switch**

Can be used as the master on/off switch for computer equipment connected to the battery power supplied outlets.

#### **6. Power On Indicator**

This LED is illuminated when the utility condition is normal and the UPS outlets are providing "clean" power, free of surges and spikes.

#### **7. Electrical Wiring Fault Indicator**

This LED indicator will illuminate to warn the user that a wiring problem exists **with the AC outlet**. If this LED is illuminated, user is advised to unplug all electrical equipment from the outlet and have an electrician check the outlet to insure proper wiring.

#### **8. AVR Indicator**

This LED indicates that the UPS is operating in automatic voltage regulation mode.

#### **9. Using Battery Indicator**

This illuminates during a utility failure, indicating that the battery is supplying power to the battery power supplied outlets.

#### **10. Check Battery**

This illuminates indicating a weak battery. If the indicator is still illuminated after allowing the unit to charge for 12 hours, replace the battery according to the instructions in the **Replacing the Battery** section of this manual.

#### **11. Serial Port to PC**

**This port allows connection and communication from the DB-9 serial or USB port on the computer to the UPS unit.** The UPS communicates its status to the PowerPanel Plus™ software. This interface is also compatible with the UPS service provided by **Windows NT, Windows 2000 and Windows XP.**

#### **12. Communication Protection Ports**

Communication protection ports will protect any standard modem, fax, or telephone line.

**HARDWARE INSTALLATION GUIDE**

1. Your new UPS may be used immediately upon receipt. However, **recharging the battery for at least four hours** is recommended to insure that the battery's maximum charge capacity is achieved. Charge loss may occur during shipping and storage. To recharge the battery, simply leave the unit plugged into an AC outlet. The unit will charge in both the on, as well as the off, position.

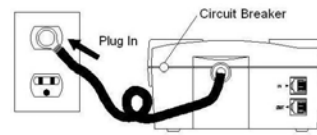

2. If you wish to use the software, connect either the enclosed serial interface or USB adapter cable to the serial port on the UPS and an open serial or USB port on the computer. If you are not going to use the software, you do not need to connect a cable.



3. With the UPS unit off and unplugged, connect your computer, monitor, and any externally powered data storage device (Zip drive, Jazz drive, Tape drive, etc...) into the battery power supplied outlets. Plug your peripheral equipment (printer, scanner, speakers) into the full-time surge protection outlets. **DO NOT plug a laser printer, copier, space heater, vacuum or other large electrical device into the UPS. The power demands of these devices will overload and possibly damage the unit.**

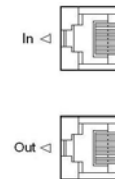

4. To protect a fax, telephone or modem line, connect a telephone cable from the wall jack outlet to the in jack of the UPS. Connect a telephone cable from the out jack on the UPS to the modem port, computer, telephone, or fax machine.

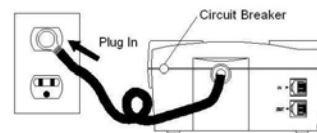

5. Plug the UPS into a properly grounded wall outlet. Make sure the wall outlet is protected by a fuse or circuit breaker and does not service equipment with large electrical demands (e.g. refrigerator, copier, etc...). Avoid using extension cords. If used, the extension cord must be rated for 15 amps. **DO NOT plug an extension cord, surge suppressor or other multiple outlet device into the battery supplied outlets of the product. This will cause an overload and will also VOID the warranty.**
6. Depress the power switch to turn the unit on. The power on indicator light will illuminate.
7. If an overload is detected, an audible alarm will sound and the unit will emit one long beep. To correct this, turn the UPS off and unplug at least one piece of equipment from the battery power supplied outlets. Wait 10 seconds. Make sure the circuit breaker is depressed and then turn the UPS on.
8. Your UPS is equipped with an auto-charge feature. When the UPS is plugged into an AC outlet, the battery will automatically recharge.
9. To maintain optimal battery charge, leave the UPS plugged into an AC outlet at all times.
10. To store your UPS for an extended period, cover it and store with the battery fully charged. Recharge the battery every three months to insure battery life.

---

**POWERPANEL PLUS™ SOFTWARE INSTALLATION GUIDE**

**Overview**

PowerPanel Plus™ version 2.1.4 or greater is designed for use with Windows 95, Windows 98, Windows Me, Windows NT, Windows 2000 and Windows XP. The latest version can be downloaded from [www.cyberpowersystems.com/downloads.htm](http://www.cyberpowersystems.com/downloads.htm). It works in conjunction with the UPS to provide full protection of valuable computer systems, applications and data. In the event of a power failure, PowerPanel Plus™ automatically saves and closes open files under auto-assigned file names or existing files names after software controlled delay. The computer and UPS are automatically shutdown to conserve battery power. Files with auto-assigned names will be saved under **C:\PCTemp**, where **C** is the name of your main hard drive. Files that have previously been saved will be saved in their original location.

PowerPanel Plus™ is equipped with a **Scheduled Shutdown** feature that can automatically save and close open files and then shutdown the computer and UPS at a user specified date and time as well as start the computer at a user specified date and time. Use of this feature is optional and is not required for the power failure shutdown to occur. The use of the PowerPanel Plus™ software is optional. The UPS unit will provide full surge suppression and battery backup without the software. You must use the software if you wish to have the automatic shutdown feature.

### **Installation Guide**

(Cyber Power UPS can provide surge suppression and battery backup without the software. However, if you need to schedule for UPS Auto-shutdown, then it is necessary to install the software.)

#### **USB Function (Optional)**

1. Turn off your UPS
2. Connect the serial interface cable to your UPS and the open serial port on the rear panel of the computer. If you would like to use USB interface, please connect the USB adapter with the Serial Cable then connect the USB to your computer. (See the figure)
3. Plug the UPS into an AC outlet, turn the UPS on and start your computer.
4. Follow the instructions on the User's Manual to complete the installation.



#### **For Windows 95 /98 /ME**

1. Turn the UPS off and unplug it.
2. Connect the serial interface cable to serial port on the UPS and an open serial port on the back of the computer. (Note: You must use the serial cable that was supplied with the unit).
3. Plug the UPS into an AC outlet, turn the UPS on, and then start your computer.
4. Windows will find new hardware.
5. Insert the PowerPanel Plus™ disk into the floppy drive, then follow the on-screen instructions.
6. When the installation is completed, remove the floppy disk.

#### **For Windows NT**

1. Click on **Start**, point to **Settings**, and then click **Control Panel**.
2. Double-click on the **UPS icon**.
3. Remove the check mark from the box labeled **UPS is installed on**, and Click **OK**.
4. Acknowledge the message that the UPS is in an unknown state.
5. Exit to the desktop, then shutdown your computer.
6. Turn the UPS off and unplug it.
7. Connect the serial interface cable to serial port on the UPS and an open serial port on the back of the computer. (Note: You must use the serial cable that was supplied with the unit).
8. Plug the UPS into an AC outlet, turn the UPS on and then start your computer.
9. Click on **Start**, point to **Settings**, and then click **Control Panel**.
10. Double-click on **Add / Remove Programs**.
11. Insert the PowerPanel Plus™ disk into the floppy drive, and then click Install.
12. Follow the on-screen instructions.
13. When the installation is completed, remove the floppy disk.

#### **For Windows 2000**

1. Click on **Start**, point to **Settings**, and then click **Control Panel**.
2. Double-click on **Power Options**.
3. On the UPS Tab, click **Select**.
4. In the UPS Selection Dialog Box, under Manufacturers, click **None**.
5. Exit to the desktop and shutdown the computer.
6. Turn the UPS off and unplug it.
7. Connect the serial interface cable to the UPS and an open serial port on the back of the computer. (Note: You must use the serial cable that was supplied with the unit).
8. Plug the UPS into an AC outlet, turn the UPS on and then start your computer.
9. Windows will find new hardware.
10. Insert the software disk into the floppy drive and follow the on-screen instructions.
11. When the installation is completed, remove the floppy disk.

#### **For Windows XP (Home and Professional)**

1. Click on **Start** and then click on **Control Panel**.
2. Double-click on **Power Options** then click on the **UPS tab**.
3. Set the manufacturer to **None**.
4. Exit to the desktop and shutdown your computer.

5. Turn the UPS off and unplug it.
6. Connect the serial interface cable to serial port on the UPS and an open serial port on the back of the computer. (Note: You must use the serial cable that was supplied with the unit).
7. Plug the UPS into an AC outlet, turn the UPS on and start your computer.
8. Windows will find new hardware.
9. Insert the PowerPanel Plus™ disk into the floppy drive.
10. Follow the on-screen instructions.
11. When the installation is completed, remove the floppy disk.



When the installation is completed, the PowerPanel Plus™ software will appear on your screen for a few seconds, and then minimize. It will appear as a blue and white battery icon located in the system tray, near the clock.

## Operating Instructions

### PowerPanel Plus™ Main Menu (See Figure 1)

1. **Log:** Click on the log button to open the **Log Window**.
2. **Power:** Click on the power button will exit the software window.
3. **Minimize Button:** Click this button to minimize the software.
4. **Setup:** Click the setup button to open the **Setup Window**.
5. **Model:** This shows the model of the CyberPower UPS that is being used.
6. **Version:** This shows the **hardware version**.
7. **Status Bar:** The area display messages about the status of the software.
8. **Schedule:** Click this button to open the **Schedule Window**.



Figure 1

### PowerPanel Plus™ Main Window Description (See Figure 2)

1. **Battery Level:** This indicator displays the current charge on the battery. The indicator will display a red color when a power failure occurs.
2. **Input Voltage:** This reading shows the current input voltage of the utility power. The input normally appears in green, but will turn red if the input voltage is not operating normally.
3. **Frequency:** This indicator displays the frequency of the utility power.
4. **Scheduled On:** PowerPanel Plus™ can be scheduled to turn your computer system on. This indicator displays scheduled on settings that will occur in the next seven days.
5. **Final Countdown:** When PowerPanel Plus™ detects that the utility voltage is not operating normally, the final countdown will begin. When the countdown reaches zero, PowerPanel Plus™ will save and close any open files, and then shut down the operating system in an intelligent and orderly manner.
6. **Approximate Backup Time:** This indicator shows the approximate amount of backup time that is available, based upon the battery capacity and the load on the system. This indicator can appear in red, yellow, or green, depending upon the number of minutes available.
7. **Scheduled Off:** PowerPanel Plus™ can be set to automatically shutdown the computer system at a user specified time scheduled off settings that are set to occur within seven days will be displayed.
8. **Temperature:** This indicator displays the internal operating temperature of the unit. If the temperature exceeds 158°F (70°C), the indicator will change from green to red.
9. **Load Level:** This indicator shows the % of capacity of the battery outlets that is currently being used. This indicator appears in green or gray, but will turn red if the load exceed 90%.
10. **Output Voltage:** This indicator shows the output voltage of the UPS.

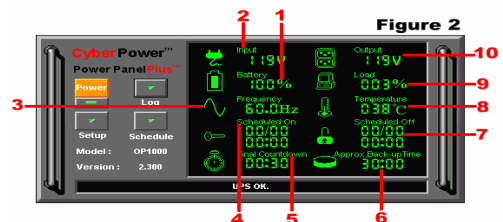

Figure 2

### PowerPanel Plus™ Setup Window (See Figure 3)

1. **UPS is Installed On:** This shows the current port that the UPS is using. The port assigned to the UPS needs to be used exclusively for the PowerPanel™ software.
2. **Buzzer On:** This toggles the audible alarm on and off.
3. **Play Sound:** Voice is being played when the UPS is turning on or facing a power outage.
5. **Time between Power Failure and Initial Warning:** This setting determines the delay between when the power fails and the first audible alarm.
6. **Delay between Warning Messages:** User adjustable setting for the delay between the audible alarms that occur during a power failure.
4. **Time between Power Failure and Shutdown:** This is the user controllable delay between when the power fails and the software starts the shutdown process. If unchecked, the unit will run on battery until the low battery signal is received (2 minutes of backup time remaining) and then start the shutdown process.
7. **UPS Self-Test:** Allows the user to test the UPS without having to unplug the unit from the wall. When **Run** is clicked, the unit will switch to battery power and the unit will beep.



8. **About:** This button will display information about the software, as well as contact information.
9. **Advance:** This button opens the **Advanced Setup Window**.
10. **Default:** Click this button to return the software to original factory settings.
11. **Cancel:** This button exits the window **without saving changes**.
12. **OK:** This button exits the window **and saves changes**.

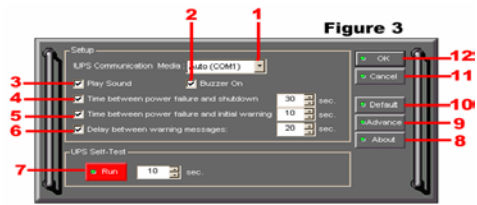

### PowerPanel Plus™ Advanced Setup (See Figure 4)

1. **Low Battery Voltage:** This sets the low battery cut-off level. The user can slightly extend the UPS run time by adjusting this setting.
2. **High-Voltage Failure:** Sets the upper level where the UPS will switch to battery.
3. **Low-Voltage Failure:** Sets the lower level where the UPS will switch to battery.
4. **Battery-Mode Output Voltage:** Sets the voltage that the unit will output when running on battery.
5. **Default:** Restores the settings to the factory defaults.
6. **Cancel:** Exits the window **without saving changes**.

7. **OK:** Exits the windows **and saves changes**.
8. **Cold Start:** When enabled, the UPS can start in the absence of AC power. To maximize battery life, it is recommended to keep this disabled.

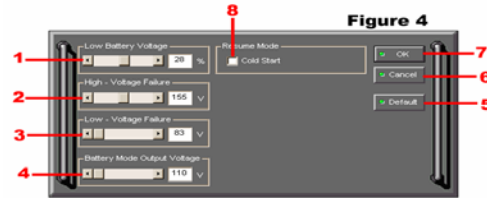

### PowerPanel Plus™ Schedule Menu (See Figure 5)

1. **Special Setting:** This setting allows you to schedule a one-time startup/shutdown.
2. **Schedule Display:** This area displays the days/dates and times of any scheduled startups and shutdowns.
3. **Turn On:** Select the day/date and time that you want the computer system to restart. Can only be used in conjunction with a scheduled shutdown.
4. **Delete:** Delete the selected item from the schedule.
5. **Add:** Adds an item to the schedule.
6. **Cancel:** This button is used to exit the log window **without saving any changes**.
7. **OK:** This button is used to exit the shutdown window **and save any changes**.

8. **Turn Off:** Select the day/date and time that you want the system to shutdown. This is optional to use and has no effect on whether your computer will shut down during a power failure.
9. **Weekly Setting:** Allow you to schedule a shutdown/startup based on the day of the week.

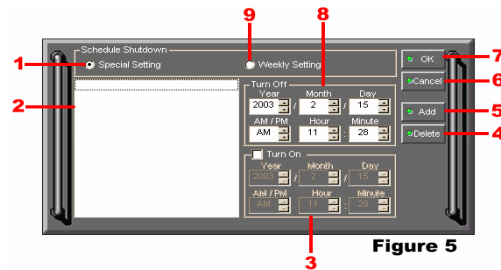

*Please note: You must click Add to add the item to the schedule.*

### PowerPanel Plus™ Log Menu (See Figure 6)

1. **Event Option Button:** When this option is selected, the log will display different PowerPanel Plus™ events, such as power failure, program start, and program end.
2. **Log Display:** This area displays the information as selected by the **Event, Closed Application Information, or Data Record** option button.
3. **Clear:** Clears the selected log.
4. **Cancel:** Exits the screen **without saving any changes**.
5. **OK:** Exits the screen **and saves any changes**.
6. **Data Record Option Button:** When selected, the log will display a record of the items that are shown in the main window, such as input/output voltage and temperature.

7. **Closed Application Information Option Button:** When this option is selected, the log will display the names and locations of any files that were auto-saved by the software

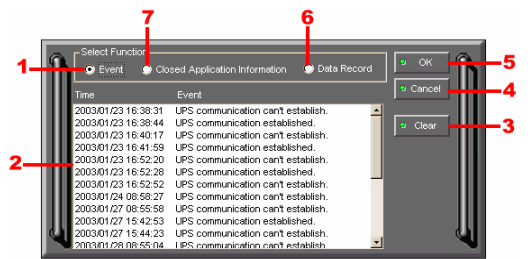

Figure 6

### **TESTING YOUR UPS SYSTEM**

Once you have set up your UPS system, you may wish to test it. Make sure that the UPS has been charged for at least 4 hours before performing this test.

**If you are using PowerPanel Plus™:**

1. With your UPS and computer on, open an application such as notepad.
2. Enter some data into the application.
3. Unplug the UPS from the AC outlet.

When a power failure occurs, PowerPanel Plus™ will appear on the screen. The outlet and battery symbols will change to indicate a power failure. The countdown timer will move towards zero. When the timer reaches zero, the software will begin to save and close any open applications. The software will auto-assign names to any files that have not been previously saved, and then save the file to the **PCTemp** folder which is located in the root directory of your **C drive** (where **C** is the name of your main hard drive). Once all open files have been saved and closed, PowerPanel Plus™ will shut down the operating system. Once the operating system is shutdown, the UPS will turn off within 90 seconds. Wait until the UPS has turned off before plugging the UPS back into the outlet.

Once the test has been completed, plug the UPS back into the AC outlet and turn it back on. You may then restart your computer. Please allow 4 hours for the UPS to recharge before attempting another self-test.

**If you are not using PowerPanel Plus™:**

1. Have your computer and UPS turned on.
2. Unplug the UPS from the wall to simulate a power failure.
3. The UPS will begin beeping, indicating a power failure.
4. Save and close any open files.
5. Shut down the operating system.
6. Once the computer system is shutdown, turn the UPS off.

As the battery discharges, the unit will beep more rapidly, indicating that the battery is nearing discharge. Once the test is complete, plug the UPS back in to the AC outlet and start your computer. Please allow 4 hours for the UPS to recharge before attempting another self-test.

---

### **REPLACING THE BATTERY**

Contact your dealer or call the number in this manual for information on battery replacement. The order numbers for the battery are as follows:

**BA-CPS1100AVR** for CPS1100AVR

**CAUTION!** Read and follow the **IMPORTANT SAFETY INSTRUCTIONS** before servicing the battery. **Service the battery under the supervision of personnel knowledgeable of batteries and their precautions.**

**CAUTION!** Use only the specified type of battery. See your dealer for replacement batteries.

**CAUTION!** The battery may present risk of electrical shock. Do not dispose of battery in a fire, as it may explode. Follow all local ordinances regarding proper disposal of batteries.

**CAUTION!** Do not open or mutilate the batteries. Released electrolyte is harmful to skin and eyes and may be toxic.

**CAUTION!** A battery can present a high risk of short circuit current and electrical shock.

Take the following precautions before replacing the battery:

1. Remove all watches, rings or other metal objects.
2. Only use tools with insulated handles.
3. Do not lay tools or metal parts on top of battery or any terminals.
4. Wear rubber gloves and boots.
5. Determine if the battery is inadvertently grounded. If inadvertently grounded, remove source of ground. **CONTACT WITH GROUNDED BATTERY CAN RESULT IN ELECTRICAL SHOCK!** The likelihood of such shock will be reduced if such grounds are removed during installation and maintenance (applicable to a UPS and a remote battery supply not having a grounded circuit).



***TO REPLACE THE BATTERY***

1. Turn off and unplug all connected equipment.
2. Turn the UPS off and unplug it from the AC power source.
3. Turn the UPS upside down.
4. Remove the 6 retaining screws.
5. Turn the UPS right side up and remove the outlet cover.
6. Remove the battery from the compartment.
7. Disconnect the battery wires from the battery.
8. Install the replacement battery by connecting the **red wire to the positive (+) terminal of the battery** and connecting the **black wire to the negative (-) terminal of the battery**.
9. Slide the battery back into the compartment.
10. Replace the outlet cover and the 6 retaining screws.
11. Recharge the unit for 4 – 8 hours to ensure the UPS performs expected runtime.

**REMINDER:** Batteries are consider **HAZARDOUS WASTE** and must be disposed properly. Contact your local government for more information about proper disposal and recycling of batteries.

# CPS1100AVR

## Guaranteed Uninterruptible Power System

### DEFINITIONS FOR ILLUMINATED LED INDICATORS

 Power On	 Wiring Fault	 AVR	 Using Battery	 Check Battery	 Circuit Breaker	 Alarm	Condition
On	Off	Off	Off	Off	Set	Off	Normal
On	Off	Flash	Off	Off	Set	Off	AVR- AVR is maintaining a consistent 120v level ( $\pm 5\%$ ) during a power sag.
ON	Off	On	Off	Off	Set	Off	AVR- AVR is maintaining a consistent 120v ( $\pm 5\%$ ) during a power surge
Off	On/Off	Off	On	Off	Set	Two Beeps	Utility Failure- The UPS is providing battery power to the Battery-Power Supplied outlets.
Off	On/Off	Off	On	Off	Set	Rapid Beeps	Utility Failure- The UPS is providing battery power. The rapid beeps indicate the battery will run out of charge within a few minutes.
Off	Off	Off	On	Off	Up	Two beeps or rapid beeps	Overload- Occurs in the Full-time Surge Protection Outlets. Turn the UPS off and unplug at least one piece of equipment from the UPS. Wait 5 seconds, reset the circuit breaker and turn the UPS on.
On/Off	On/Off	On/Flash/Off	On/Off	Off	Set	Long Beep	Overload- Occurs in the Battery-power Supplied Outlets. Turn the UPS off and unplug at least one piece of equipment from the UPS. Wait 5 seconds, reset the circuit breaker and turn the UPS on.
Off	Off	Off	On	Off	Up	Long Beep	Overload- Occurs in the Battery-power Supplied Outlets. Turn the UPS off and unplug at least one piece of equipment from the UPS. Wait 5 seconds, reset the circuit breaker and turn the UPS on.
On	On/Off	On/Flash/Off	Off	On	Set	None	Weak Battery- Recharge the battery for at least 8 hours. If Check Battery is illuminated contact CyberPower Systems for battery replacement information.
Off	Off	Off	Off	Off	Set	Off	Surge Protection Malfunction- Lightning induced power line surge has damaged the surge-protect function. Please contact CyberPower Systems
On/Off	On/Off	On/Flash/Off	Flash	Flash	Set/Up	Off	Scheduled Turn-on- If the two battery indicators are flashing in rotation, the UPS is waiting to turn on as configured in the schedule.
On/Off	On/Off	On/Flash/Off	Flash	Flash	Set/Up	Three Beeps	Cold Start Disabled- If the two battery indicators are flashing at the same time, the cold-start has been disabled. The UPS will not start in the absence of AC power.
On/Off	On	On/Flash/Off	On/Off	On/Off	Set/Up	None	Electrical Wiring Fault- This indicates a wiring a problem such as a bad ground, missed ground or reversed wiring within the AC outlet. User is advised to disconnect all electrical equipment from the outlet and have the outlet checked by an electrician.

### Sample Systems

Desktop PC with LCD Monitor	62-82
Desktop PC with 15" Monitor	57-70
Desktop PC with 17" Monitor	50-58
Desktop PC with 21" Monitor	40-48

# CPS1100AVR

## Guaranteed Uninterruptible Power System

### TROUBLESHOOTING

Problem	Possible Cause	Solution
Full-time surge protection outlets stop providing power to equipment.	Circuit breaker has tripped due to an overload.	Turn the UPS off and unplug at least one piece of equipment. Wait 10 seconds, reset the circuit breaker by depressing the button, and then turn the UPS on.
The UPS does not perform expected runtime.	Battery not fully charged.	Recharge the battery by leaving the UPS plugged in.
	Battery is slightly worn out.	Contact CyberPower Systems about replacement batteries at <a href="mailto:tech@cyberpowersystems.com">tech@cyberpowersystems.com</a>
The UPS will not turn on.	The on/off switch is designed to prevent damage by rapidly turning it off and on.	Turn the UPS off. Wait 10 seconds and then turn the UPS on.
	The unit is not connected to an AC outlet.	The unit must be connected to a 110/120v 60Hz outlet.
	The battery is worn out.	Contact CyberPower Systems about replacement batteries at <a href="mailto:tech@cyberpowersystems.com">tech@cyberpowersystems.com</a>
	Mechanical problem.	Contact CyberPower Systems about at <a href="mailto:tech@cyberpowersystems.com">tech@cyberpowersystems.com</a>
PowerPanel™ Plus is inactive (all icons are gray).	The serial cable is not connected.	Connect the serial cable to the UPS unit and an open serial port on the back of the computer. You must use the cable that came with the unit.
	The serial cable is connected to the wrong port.	Check the back of the computer for an additional serial port. Move the cable to this port.
	The unit is not providing battery power.	Shutdown your computer and turn the UPS off. Wait 10 seconds and turn the UPS back on. This should reset the unit.
	The serial cable is not the cable that was provided with the unit.	You must use the cable that was included with the unit for the software and the unit to be able to communicate.

### SPECIFICATIONS

General	Model	CPS1100AVR
Input	Capacity	1100VA (660W)
	Frequency	57Hz to 63Hz
	Voltage Range	90v – 145v
UPS-Output	Line Conditioning Regulation	AVR Max. boost 12% of input voltage for output regulation while input voltage is from 10% to 30% under nominal. AVR buck 12% of input voltage for output regulation while input voltage is from 10% to 26% over nominal
	On Battery Output Voltage Regulation	120 Vac ±5% (user adjustable)
	Transfer Time	4ms typical, including detection time
	On Battery Output Wave Form	Simulated Sine Wave Form
	Max. Load	1100VA(660W)
Full-time Surge Protection Output	Max. Load	12 Amps
Battery	Battery Type	Sealed, Maintenance-free lead acid battery
	Number of Batteries	12Vdc/7.2AH x 2
	Recharge Time	4 to 8 hours from total discharge
Physical	Operating Temperature	+32°F to 104°F (0°C to 40°C)
Interface	Communication	RS-232 with Plug and Play interface / USB Adapter Win 98, Win NT, Win 2000, Win ME, Win XP
	LED Indicators	Power On, Electrical Wiring Fault, AVR, Using Battery, Check Battery
	Output Receptacles	3 Battery-powered and full-time surge protection
		6 full-time surge protection

**LIMITED WARRANTY AND  
POWER CONTROL GUARANTEE**

In purchasing a CPS1100AVR in the United States or Canada, the original end user receives a **Limited Warranty** and CyberPower's **Power Control Guarantee** from Cyber Power Systems (USA), Inc. (for ease of reading, referred to as "CyberPower"). The Limited Warranty and the Power Control Guarantee are intended to be the initial end-user's exclusive rights and remedies. The Limited Warranty and the Power Control Guarantee are separate, all though they are related.

**Limited Warranty.** The original end user (referred to as the "Initial Customer") receives an express limited warranty for the CPS1100AVR (referred to as the "Limited Warranty"), purchased from CyberPower (referred to as the "Product"). The Limited Warranty is for the Product itself. The terms of the Limited Warranty are explained below.

**Power Control Guarantee.** CyberPower also provides the Initial Customer with protection in the event that the Product is not free from defects in materials and workmanship, and certain equipment connected to the Product is damaged (the "Power Control Guarantee"). The Power Control Guarantee protects the Initial Customer for damage to equipment plugged into the Product. The terms of the Power Control Guarantee are explained below.

The Limited Warranty and the Power Control Guarantee are subject to the terms set forth below. Additionally, State or Provincial law may adjust the terms of the Limited Warranty or the Power Control Guarantee or the State or Province may impose additional obligations, or additional "implied warranties." To the extent necessary to comply with those laws, the terms of the Limited Warranty and the Power Control Guarantee should be read to adjust to those requirements only to the extent necessary to comply with such local law.

If you are an Initial Customer, you are asked to read the following terms and conditions carefully before using the Product. By using the Product you consent to be bound by and become a party to the Limited Warranty and Power Control Guarantee. If you do not agree to the terms and conditions of the Limited Warranty and Power Control Guarantee, you should return the Product for a full refund prior to using it.

**REGISTRATION**

CyberPower requests that you complete and return the Warranty Registration Card enclosed with the Product or register the Product at its website ([www.cyberpowersystems.com/prodreg](http://www.cyberpowersystems.com/prodreg)) to establish that you are the original end-user consumer purchaser of the Product, and therefore entitled coverage under the Limited Warranty and the Power Control Guarantee. (Registration is not required for Limited Warranty coverage, but note if you do not complete a registration card you will be required to provide proof of purchase, as described below, to have the benefits of this Limited Warranty.)

**LIMITED WARRANTY**

CyberPower warrants to you, the Initial Purchaser, that the Product will be free from defects in material and workmanship for three years from the date of original purchase, subject to the terms of this Limited Warranty.

To be covered you must still be the owner of the Product at the time of the failure that results in the claim made under this Limited Warranty.

Your exclusive remedy and CyberPowers sole obligations are as follows for the Product:

If (a) the CyberPower Product you purchased and still own is defective in material or workmanship under this Limited Warranty or any applicable warranty imposed by law, and (b) all Limited Warranty requirements have been met, CyberPower will repair or replace the Product if it proves to be defective in material or workmanship during the Warranty Period.

To make a Limited Warranty claim on a Product, you must do the following:

1. Complete and return the CyberPower Warranty Registration Card, or provide reasonable proof of purchase (for example, a sales receipt) that establishes you as the Initial Customer (the original end-user consumer purchaser) of the Product and prove that the Product was purchased within three y or 877-297-6937ears of the event for which you want to make a claim for warranty service.
2. Call CYBERPOWER at 952 403-9500; write to CYBERPOWER at 5555 12<sup>th</sup> Avenue East, Suite 110, Shakopee, MN 55379, or E-Mail CYBERPOWER at [tech@cyberpowersystems.com](mailto:tech@cyberpowersystems.com) within ten (10) days of the event for which you want to make a claim for warranty service.
3. When you call, write, or E-Mail, identify the Product, the Purchase Date, and request Return Material Authorization information from CyberPower.
4. Pack and ship the Product to CyberPower as instructed in your Return Material Authorization. Show the Return Material Authorization code on the shipping label or include it with the Product. **You must prepay all shipping costs and you are responsible for packaging and shipment.**

CyberPower will inspect and examine the Product within ten (10) days of receipt. If the Product is not as warranted, CyberPower will repair or replace the Product and return it to you at CyberPower's expense, or, if CyberPower is unable to or decides not to repair or replace the Product (if defective) within a reasonable time, CyberPower will refund to you the full purchase price you paid for the Product (purchase receipt showing price paid is required).

# CPS1100AVR Guaranteed Uninterruptible Power System

## POWER CONTROL GUARANTEE

If you are the Initial Purchaser and the Product is still covered by the Limited Warranty, the Power Control Guarantee provides protection for damage to certain equipment connected to the Product ("Connected Equipment"), subject to certain terms and limitations.

The Power Control Guarantee is not "first dollar" coverage. CyberPower's obligation is reduced by any amounts that Initial Customer is entitled to recover from other sources regarding the Connected Equipment, including insurance, other warranty, or extended warranty coverage, whether or not the Initial Customer makes a claim for recovery, including but not limited to a claim under any applicable insurance, other warranty, or extended warranty.

The Power Control Guarantee is separate from the Limited Warranty, but they are related. The Limited Warranty does not cover Connected Equipment, but as is explained below, to be covered under the Power Control Guarantee, the Connected Equipment must have been damaged due to a failure of the Product that is covered by the Limited Warranty. The Connected Equipment must have been damaged due to a defect in materials or workmanship of the Product and the Product must still be covered by the Limited Warranty and the Initial Customer has made a valid claim for the Product under the Limited Warranty.

In the event of damage to the Connected Equipment, your exclusive remedy, and CyberPower's sole obligations, are as follows for Connected Equipment. If (a) the Product purchased and owned by you is defective in material or workmanship under the Limited Warranty or any applicable Implied Warranty; (b) the Limited Warranty requirements have been met, and; (c) none of the limitations or exclusions on warranty coverage apply, CyberPower will (as CyberPower elects, as permitted by law), repair, replace, or pay the **Agreed Damage Amount** (defined below) for the item(s) of your electronic equipment directly and properly connected to the product (the "Connected Equipment") if that Connected Equipment is (x) damaged by AC power line transients, spikes, or surges on properly installed, grounded, and code-compliant 120 volt power lines in the United States and Canada, or by transients, surges or spikes on standard telephone equipment lines, or Base 10/100T Ethernet lines that are properly installed and connected (a "Power Disturbance") and (y) is directly plugged into and properly connected to a CyberPower

Product in its original condition which is properly operated when a Power Disturbance passes through the CyberPower Product and (y.1) exhausts the protection capacity of the CyberPower Product or (y.2) damages the CyberPower Product. This provision sets out the only liability of any character of CyberPower for direct, indirect, special, consequential, and/or incidental damages under our Limited Warranty, applies only to Connected Equipment, and all such Liability is limited to the Agreed Damage Amount.

To make a Warranty claim for damage to Connected Equipment under the Power Control Guarantee, you must do the following:

1. Complete and return the CyberPower Warranty Registration Card or provide reasonable proof (for example, a sales receipt) that establishes you as the Initial Customer (the original consumer purchaser of the Product) within ten (10) days of the event for which you want to make a claim for warranty service.
2. Call CyberPower at (952)-403-9500 or 877-297-6937 (toll-free), or write to CyberPower at 5555 12<sup>th</sup> Avenue East, Suite 110, Shakopee, MN 55379, or E-Mail CyberPower at [tech@cyberpowersystems.com](mailto:tech@cyberpowersystems.com), within ten (10) days of the event for which you want to make a claim for warranty service.
3. When you call, write or E-Mail, identify the Product, the Purchase Date and the item(s) of Connected Equipment. Have information on all applicable insurance or other resources of recovery/payment that are available to the Initial Customer for the Connected Equipment and the name of the power utility supplier for the location of the Connected Equipment and request Return Material Authorization information from CyberPower.
4. Pack and ship the Product to CyberPower and, if requested by CyberPower the item(s) of Connected Equipment, a repair cost estimate for the damage to the Connected Equipment and/or a written statement of how the damage occurred, as instructed in your Return Material Authorization. Show the Return Material Authorization code on the shipping label or include it with the Product. **Initial Customer shall prepay all shipping costs and is responsible for packaging and shipment.**

CyberPower will inspect and examine the Product and the item(s) of Connected Equipment (or at CyberPower's election, your written statement and repair cost estimate for those item(s)). You must return the product for inspection.

If the Product is warranted under the Limited Warranty and the damage to Connected Equipment is covered by the Power Control Guarantee, CyberPower will (in addition to Limited Warranty remedies for the CyberPower Product itself) repair (or pay the costs of repair) or replace the Connected Equipment or, at the option of CyberPower, as permitted by law, pay to the Initial Customer the "Agreed Damage Amount" (up to the aggregate limits stated below) for all item(s) of Initial Customer's Connected Equipment. The "Agreed Damage Amount" for all items of Initial Customer's Connected Equipment shall be the lesser of the amount determined under Clause (1) or (2) below, reduced by any amounts described in Clause (3) below:

1. The fair market value of the Connected Equipment as established by the lower of (a) the price list of Orion Bluebook (or if such price list is no longer published, a published or announced price list reasonably selected by CyberPower), or (b) the lowest price the Connected Equipment can be purchased for in the United States; or
2. The aggregate ceiling amount for all Connected Equipment as set forth below, minus:
3. The amount(s) of all payment(s) you have or are entitled to receive from insurance, other warranties, extended warranties, or from other sources or persons for the Connected Equipment or damage to such equipment so that CyberPower's maximum liability shall be reduced to reflect all such other payments or sources of recovery: CyberPower CPS1100AVR-\$350,000.00
4. If CyberPower replaces the Connected Equipment or pays to the Initial Customer the Agreed Damage Amount, the Initial Customer shall transfer such item(s) to CyberPower without warranty by the Initial Customer, but free of lien or other interest.

## CONDITIONS COMMON TO THE LIMITED WARRANTY AND THE POWER CONTROL GUARANTEE

The Limited Warranty and the Power Control Guarantee are the only and the exclusive express warranty of CyberPower with respect to the Product. This exclusion of other express warranties applies to written and oral express warranties. **Any Implied Warranty of Merchantability or for Fitness for a Particular Purpose, if applicable to the Product, is limited in duration to the period of ownership by the Initial Customer. This provision shall NOT create any Implied Warranty or Merchantability or of Fitness for a Particular Purpose that would not Otherwise apply to the Product.** NOTE: Some States do not allow limitations on how long an implied warranty lasts, so the above limitation may not apply to you.

# CPS1100AVR

## Guaranteed Uninterruptible Power System

### LIMITATION: THE LIMITED WARRANTY AND THE POWER CONTROL GUARANTEE DO NOT COVER

The Limited Warranty and the Power Control Guarantee are intended to exclusive rights and remedies and replace any other rights, to the extent allowed by law.

1. As to CyberPower products, the Limited Warranty does not cover or apply to: Misuse; modification; operation or storage outside environmental limits for the Products; in transit, in shipment, or in storage, damage or deterioration; improper operation or maintenance; use with items or equipment not designed or intended for use with the Product.
2. As to Connected Equipment, the Power Control Guarantee covers only damage within the specific terms of the Power Control Guarantee to Connected Equipment (and only up to the applicable aggregate ceiling amount). The Power Control Guarantee does not cover damage to Connected Equipment or apply if the product has been operated in a failure mode or not in compliance with CyberPower operating instructions and manuals and/or with the instruction and manuals of its manufacturer/vendor.

### The Limited Warranty and the Power Control Guarantee Do Not Apply Unless The Initial Customer:

1. Has properly connected the Product and the Connected Equipment to properly wired and grounded outlets/power supplies (including compliance with electrical and safety codes of most current National Electrical Code, ANSI/NFPA 70), without the use of any adaptors, extension cords, or other connectors.
2. Has provided a suitable and proper environment for use and installation of the Product and Connected Equipment.
3. Has properly installed and operated the CyberPower Product and Connected Equipment.

### CyberPower Does Not Cover or Undertake Any Liability in Any Event for Any of the Following:

1. Loss of or damage to data, records, or software; restoration of data or records; or reinstallation of software.
2. Damage from causes other than AC Power Line Transients, spikes, or surges on properly installed, grounded and code-compliant 120 volt power lines in the United States and Canada; transients, surges, or spikes on standard telephone land lines, PBX telephone equipment lines or Base 10/100T Ethernet lines, when properly installed and connected. (This exclusion applies, for example, to fluctuations in data transmission or reception, by CATV or RF transmission or fluctuations, or by transients in such transmission).
3. Damage from any circumstance described as excluded above with respect to the Product.
4. Damages from fire, flood, wind, rain, rising water, or leakage or breakage of plumbing; from abuse, misuse, or alteration of either the Product or the Connected Equipment.

**Exclusion of Consequential and Other Damages.** The sole and exclusive remedies of the Initial Customer are those provided by the Limited Warranty and Power Control Guarantee. **CyberPower excludes any liability for personal injury under the Limited Warranty and Power Control Guarantee. CyberPower excludes any liability for direct, indirect, special, incidental or consequential damages, whether for damage to or loss of property, loss of profits, business interruption, loss of information or data, EXCEPT FOR (AND ONLY FOR) the specific limited agreement of CYBERPOWER to provide certain warranty benefits regarding "Connected Equipment" under the "CYBERPOWER Power Control Guarantee".** NOTE: Some States or Provinces do not allow the exclusion or limitation of incidental or consequential damages, so the above limitation may not apply to you.

### DO NOT USE FOR MEDICAL OR LIFE SUPPPORT EQUIPMENT OR OTHER HIGH RISK ACTIVITIES.

**CyberPower does not sell the Products for use in high-risk activities. The Product is not designed or intended for use in hazardous environments requiring fail-safe performance, including the operation of nuclear facilities, aircraft navigation or communication systems, air traffic control, weapons systems, life support or medical applications or for use in any circumstance in which the failure of the Product could lead directly to death, personal injury, or severe physical or property damage, or that would affect operation or safety of any medical or life support device (collectively, "High Risk Activities"). CyberPower expressly disclaims any express or implied warranty of fitness for High Risk Activities. CyberPower does not authorize use of any of its products use in any High Risk Activities. ANY SUCH USE IS IMPROPER AND IS A MISUSE OF CYBERPOWER PRODUCTS.**

**The Limited Warranty and the Power Control Guarantee are governed by the laws of the United States and the State of Minnesota, without reference to conflict of law principles. The application of the United Nations Convention of Contracts for the International Sale of Goods is expressly excluded.**

Contact Information: CyberPower's address is 5555 12th Ave East, Suite 110, Shakopee, MN 55379 and its phone number is (952) 403-9500. CyberPower is the warrantor under this Limited Warranty. You may also contact CyberPower on the Internet at [www.cyberpowersystems.com](http://www.cyberpowersystems.com).



## FCC Notice

This equipment has been tested and found to comply with the limits for a Class B Digital Device, pursuant to Part 15 of the FCC Rules. These limits are designed to provide reasonable protection against harmful interference in residential installation. This equipment generates, uses and can radiate radio frequency energy and, if not installed and used in accordance with the instructions, may cause harmful interference to radio communications. However, there is no guarantee that interference will not occur in a particular installation. If this equipment does cause harmful interference to radio or television reception, which can be determined by turning the equipment off and on, the user is encouraged to try to correct the interference by one or more of the following measures: (1) Reorient or relocate the receiving antenna. (2) Increase the separation between the equipment and receiver. (3) Connect the equipment into an outlet on a circuit different from that to which the receiver is connected. (4) Consult the dealer or an experienced radio/TV technician for help. Any special accessories needed for compliance must be specified in the instruction.

CAUTION: A shielded-type power cord is required in order to meet FCC emission limits and also to prevent interference to the nearby radio and television reception. It is essential that only the supplied power cord be used. Use only shielded cables to connect I/O devices to this equipment.

CAUTION: Any changes or modifications not expressly approved by the guarantee of this device could void the user's authority to operate the equipment.



For more information, contact us at:

CyberPower Systems (USA), Inc.  
5555 12<sup>th</sup> Avenue East, Suite 110  
Shakopee, MN 55379

Toll-Free: (877)-297-6937  
Tel: (952)-403-9500  
Fax: (952)-403-0009

Email: [information@cyberpowersystems.com](mailto:information@cyberpowersystems.com)  
Web: [www.cyberpowersystems.com](http://www.cyberpowersystems.com)

Entire content copyright ©2003 CyberPower Systems, Inc.  
All rights reserved. Reproduction in whole or in part without permission is prohibited.  
PowerPanel Plus™ is a trademark of CyberPower Systems (USA), Inc.

K01-1100A0A