



# **VPAP™ Auto**

POSITIVE AIRWAY PRESSURE DEVICE

## **User Guide**

English

## VPAP™ Auto

Component of 268108/2

ILLUSTRATIONS

### A SYSTEM COMPONENTS

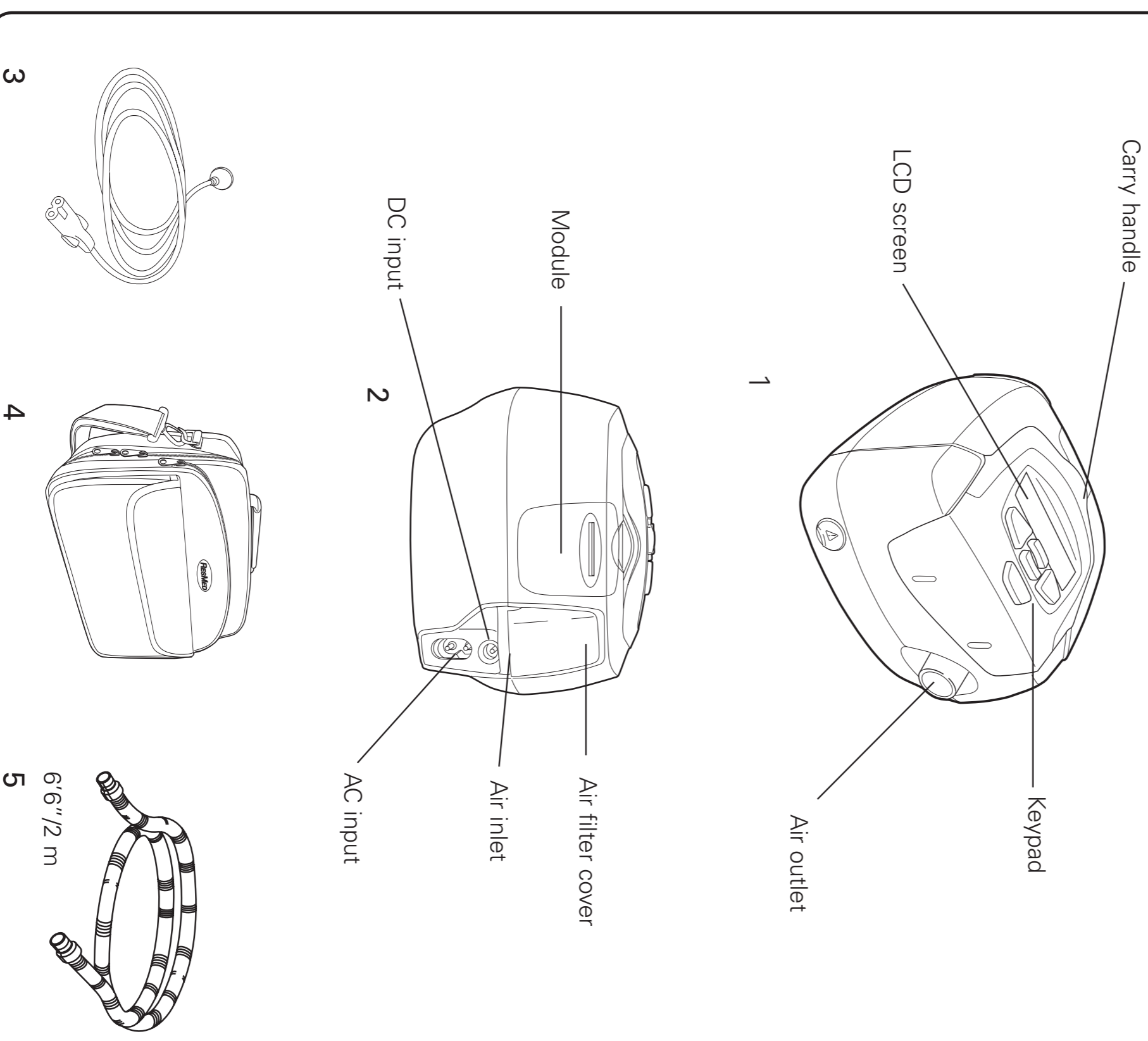

© 2007 ResMed Ltd.

### B INTEGRATED HUMIDIFIER

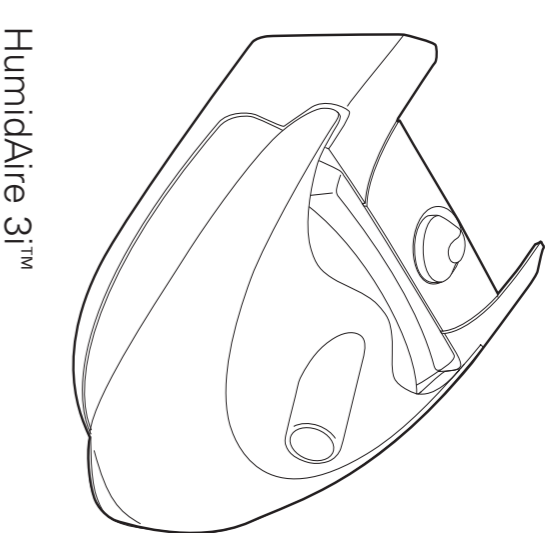

© 2007 ResMed Ltd.

### C OTHER ACCESSORIES

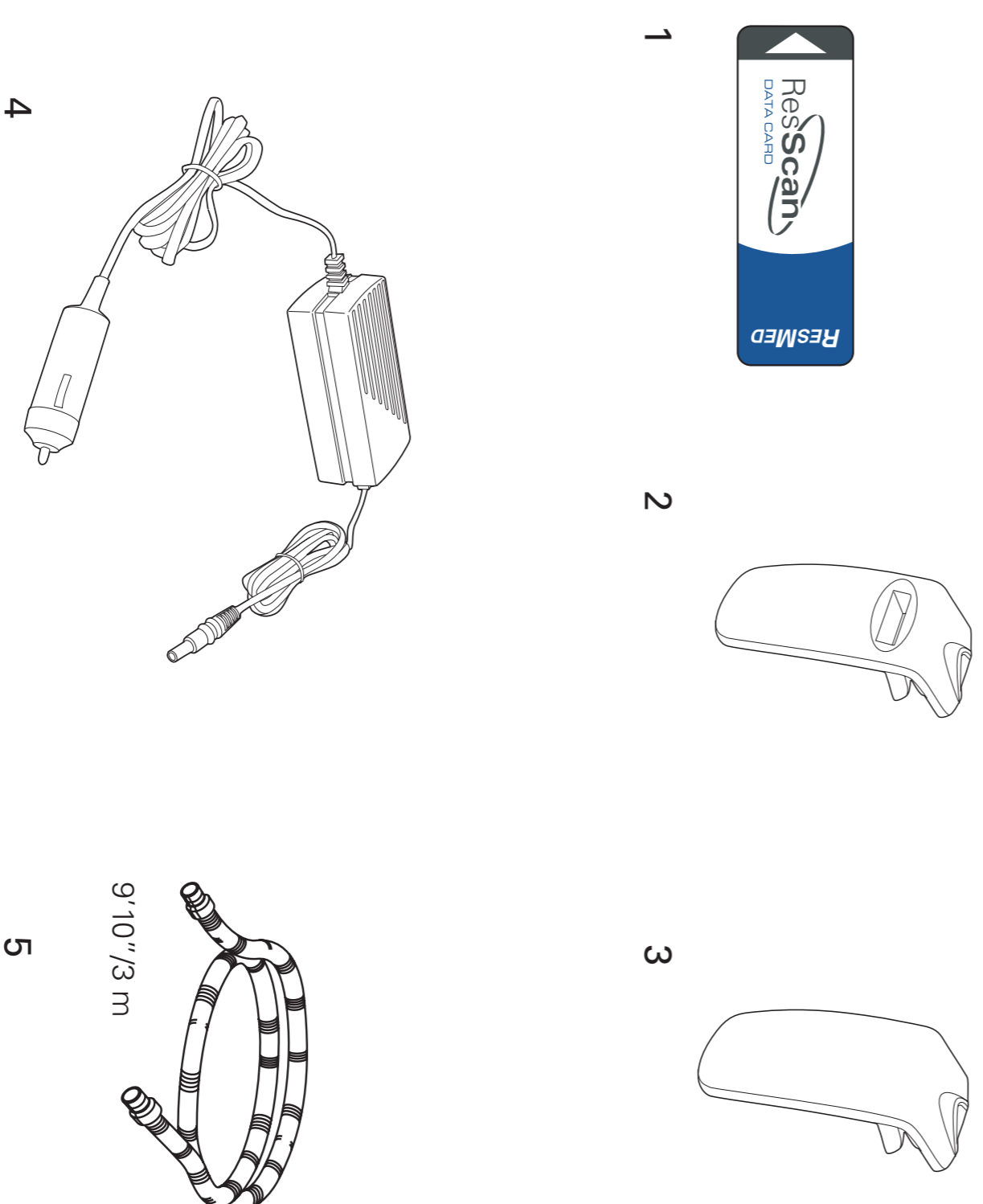

© 2007 ResMed Ltd.

### D SETTING UP THE VPAP™ AUTO

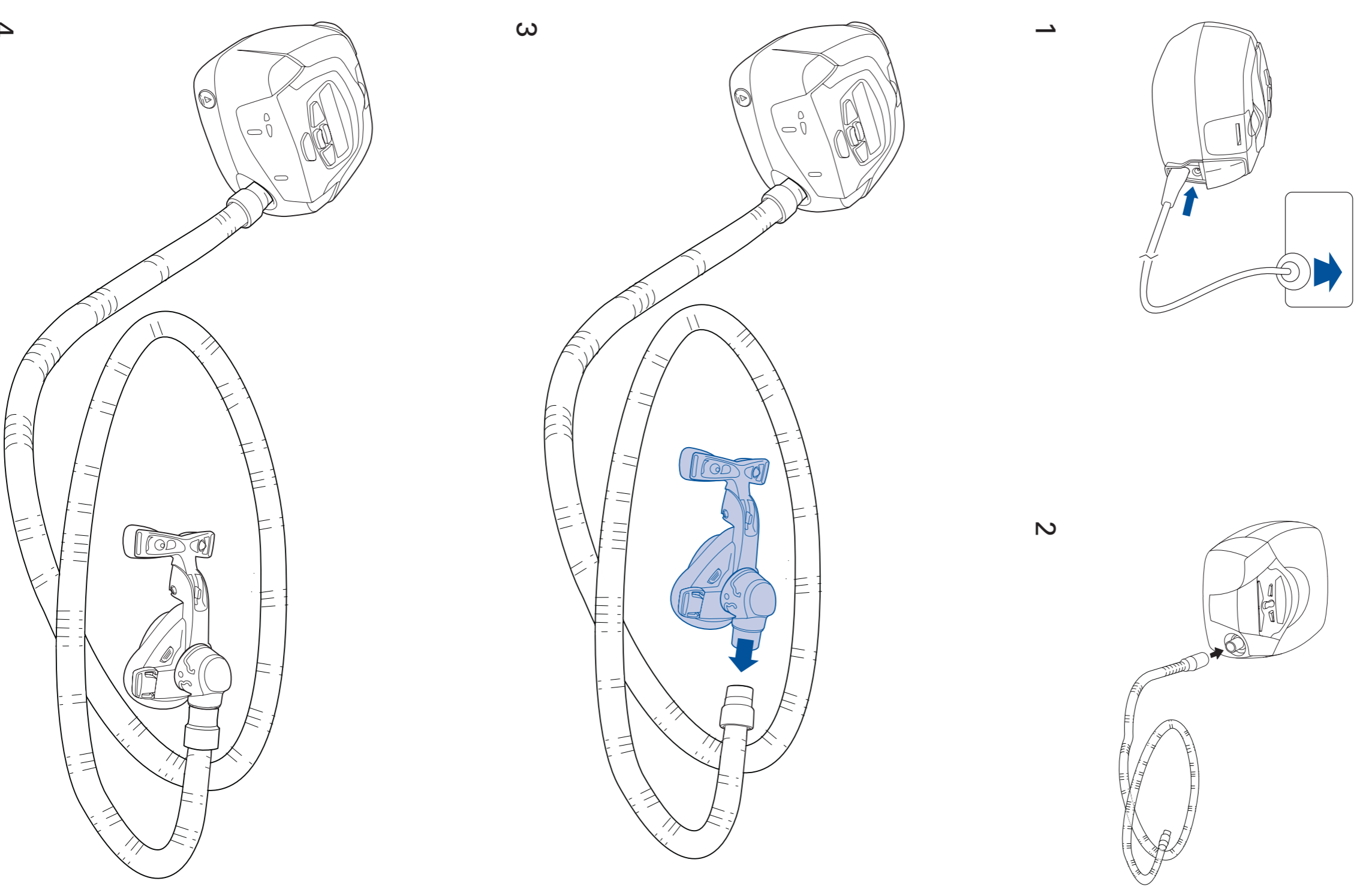

© 2007 ResMed Ltd.

**E**

HUMIDAIRE 3i AND VPAP AUTO

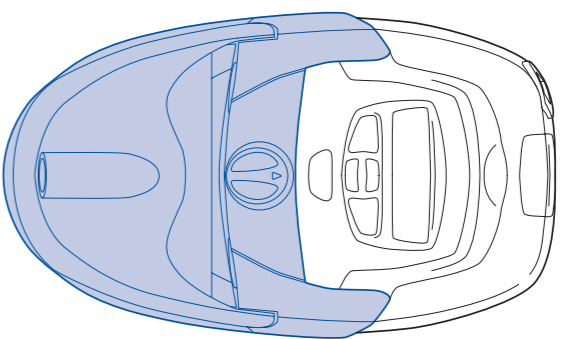

HumidAire 3i

© 2007 ResMed Ltd.

**H**

USING THE DATA CARD

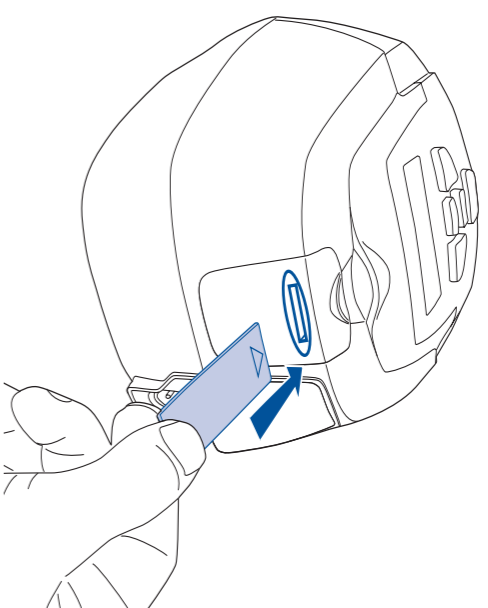

1

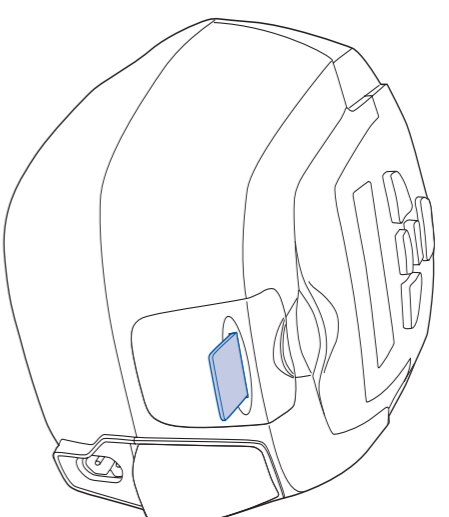

2

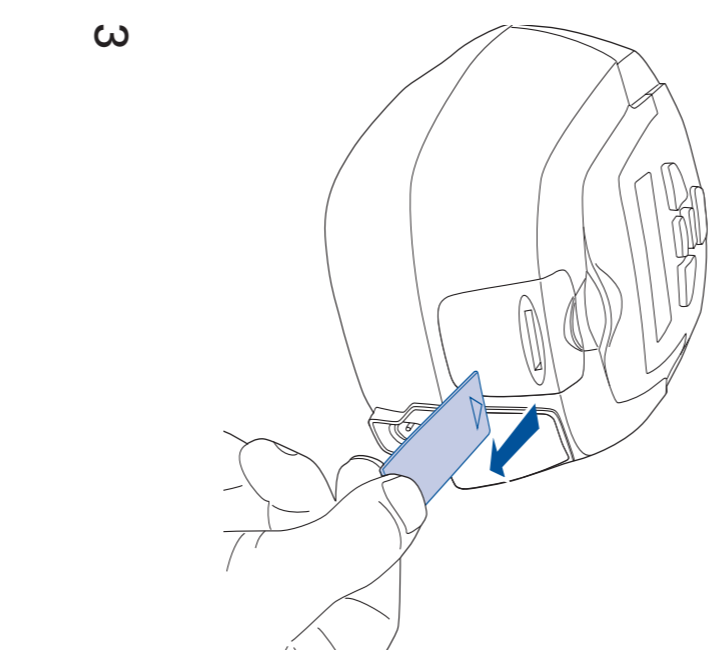

3

© 2007 ResMed Ltd.

**F**

BLANK MODULE

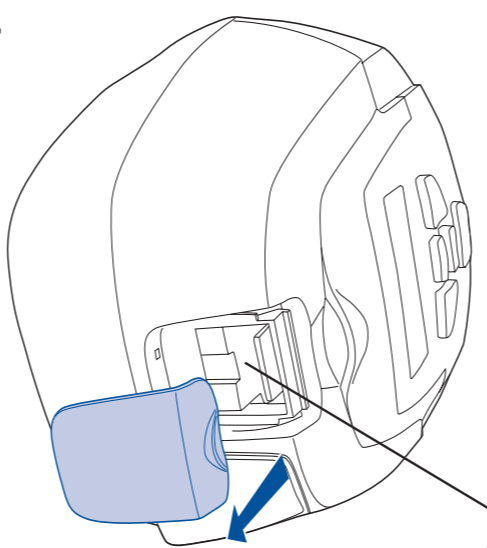

1

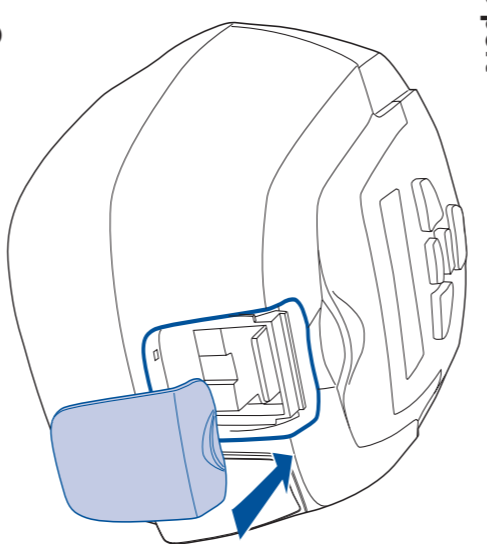
Data  
communications port

2

© 2007 ResMed Ltd.

**G**

DATA CARD MODULE

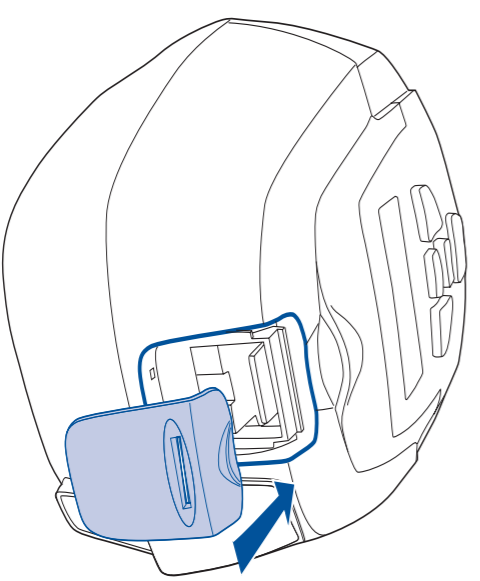

1

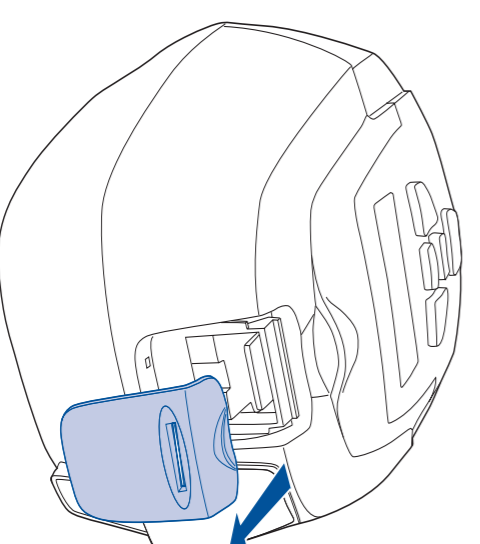

2

© 2007 ResMed Ltd.

Note: Some products not available in all regions.

***RESMED***

**VPAP™ Auto**

POSITIVE AIRWAY PRESSURE DEVICE

**User Guide**

English

**ResMed Ltd** (Manufacturer) 1 Elizabeth Macarthur Drive Bella Vista NSW 2153 Australia  
**ResMed Corp** (US Designated Agent) 14040 Danielson Street Poway CA 92064-6857 USA  
**ResMed (UK) Ltd** (EU Authorized Representative) 65 Milton Park Abingdon Oxfordshire OX14 4RX UK  
**ResMed Offices** Australia, Austria, Brazil, China, Finland, France, Germany, Hong Kong, India, Japan, Malaysia, Netherlands, New Zealand, Norway, Singapore, Spain, Sweden, Switzerland, UK, USA (see [www.resmed.com](http://www.resmed.com) for contact details).

Protected by patents: AU 691200, AU 697652, AU 699726, AU 702820, AU 709279, AU 713679, AU 724589, AU 764761, EP 0651971, EP 0661071, EP 0858352, EP 0920845, EP 0927538, EP 0934723, JP 3638613, US 4944310, US 5199424, US 5245995, US 5522382, US 5704345, US 6029665, US 6138675, US 6213119, US 6363933, US 6398739, US 6591834, US 6635021, US 6675797, US 6705315, US 6745768, US 6770037, US 6935337, US 7004908, US 7040317. Other patents pending.

Protected by design registrations: AU 302180, AU 302181, AU 302182, AU 302183, AU 302184, AU 302185, AU 302186, CN 200430121212.2, CN 200430121211.8, CN 200430121214.1, CN 200430121215.6, CN 200430121216.0, CN 200430121217.5, EP 269436, HK 0412901.9, JP 1257662, JP 1257663, JP 1266956, JP 1266957, JP 1267270, JP 1267271, NZ 405614, NZ 406923, NZ 406924. Others pending.

HumidAire, HumidAire 3i, SmartStart, AutoSet, ResScan, Ti Control, Ultra Mirage, VPAP, Vista and VPAP Auto are trademarks of ResMed Ltd. HumidAire, SmartStart, Vista, AutoSet and VPAP are registered in U.S. Patent and Trademark Office.

© 2007 ResMed Ltd. 268108/2 07 08

# Contents

<b>Introduction</b> .....	1
Definitions .....	1
User/Owner Responsibility .....	1
<b>Medical Information</b> .....	3
What the VPAP™ Auto Device is Intended for .....	3
Contraindications .....	3
Warnings .....	3
Cautions .....	5
<b>The VPAP Auto System</b> .....	7
Mask .....	7
Supplemental Oxygen .....	8
<b>Preparing for Use</b> .....	9
Setting Up the VPAP Auto .....	9
Assemble the Mask .....	9
<b>Operating Instructions</b> .....	15
Starting Treatment .....	15
SmartStart™ .....	15
Stopping Treatment .....	15
Using the Mask-Fitting Feature .....	15
Messages on the VPAP Auto LCD .....	19
Modules .....	20
Helpful Hints .....	22
<b>Cleaning and Maintenance</b> .....	25
Daily Cleaning .....	25
Weekly Cleaning .....	25
Periodic Cleaning .....	25
Replacing the Air Filter .....	26
Servicing .....	26
<b>Troubleshooting</b> .....	27
<b>Technical Specifications</b> .....	31
Accessories .....	32
Symbols which Appear on the Device .....	32
<b>Limited Warranty</b> .....	39
<b>Index</b> .....	41



# Introduction

## Definitions

This guide contains special terms and icons that appear in the margins to draw your attention to specific and important information.

- Warning alerts you to possible injury.
- Caution explains special measures for the safe and effective use of the device.
- Note is an informative or helpful note.

## User/Owner Responsibility

The user or owner of this system shall have sole responsibility and liability for any injury to persons or damage to property resulting from:

- operation which is not in accordance with the operating instructions supplied
- maintenance or modifications carried out unless in accordance with authorized instructions and by authorized persons.

**Please read this guide carefully before use.**





# Medical Information

## What the VPAP™ Auto Device is Intended for

The VPAP™ Auto is indicated for the treatment of obstructive sleep apnea (OSA) in patients weighing more than 66 lb (30 kg). It is intended for use in the hospital and home.



### **CAUTION (USA ONLY)**

Federal law restricts this device to sale by or on the order of a physician.

## Contraindications

Positive airway pressure therapy may be contraindicated in some patients with the following pre-existing conditions:

- severe bullous lung disease
- pneumothorax
- pathologically low blood pressure
- dehydration
- cerebrospinal fluid leak, recent cranial surgery or trauma.

## Warnings

- The entire manual should be read before using the VPAP Auto.
- Advice contained in this manual should not supersede instructions given by the prescribing physician.
- A patient should not connect a device to the data communication port unless instructed to do so by their health care provider or physician. Only ResMed products are designed to be connected to the data communication port. Connecting other devices could result in injury, or damage to the VPAP Auto device.
- The VPAP Auto should only be used with masks (and connectors<sup>\*</sup>) recommended by ResMed, or by a physician or respiratory therapist. A mask should not be used unless the VPAP Auto device is turned on and operating properly. The vent hole or holes associated with the mask should never be blocked.

**Explanation:** The VPAP Auto is intended to be used with special masks (or connectors<sup>\*</sup>) which have vent holes to allow continuous flow of air out of the mask.

When the device is turned on and functioning properly, new air from the device flushes the exhaled air out through the mask vent holes. However, when the device is not operating, insufficient fresh air will be provided

---

\* Ports may be incorporated into the mask or in connectors that are near the mask.

through the mask, and the exhaled air may be rebreathed. Rebreathing of exhaled air for longer than several minutes can, in some circumstances, lead to suffocation. This applies to most models of PAP devices.

- In the event of power failure or machine malfunction, remove the mask.
- The VPAP Auto can be set to deliver pressures up to 20 cm H<sub>2</sub>O. In the unlikely event of certain fault conditions, pressures up to 30 cm H<sub>2</sub>O are possible.
- If oxygen is used with this device, the oxygen flow must be turned off when the device is not operating. If oxygen has been left on while the device is not operating, disconnect the oxygen and wait 60 minutes before turning on the device again.

**Explanation:** When the PAP device is not in operation and the oxygen flow is left on, oxygen delivered into the ventilator tubing may accumulate within the PAP machine enclosure and create a risk of fire. This applies to most types of PAP machines.

- Oxygen supports combustion. Oxygen should not be used while you are smoking or in the presence of an open flame.
- Always ensure airflow is being generated by the device before the oxygen supply is turned on.
- Always turn the oxygen supply off before stopping the airflow from the device.

**Note:** *At a fixed rate of supplemental oxygen flow, the inhaled oxygen concentration will vary, depending on where the oxygen is introduced, the pressure settings, patient breathing pattern, mask selection and leak rate.*

- Do not use the VPAP Auto if there are obvious external defects or unexplained changes in performance.
- Do not open the VPAP Auto case. There are no user serviceable parts inside. Repairs and internal servicing should only be performed by an authorized service agent.
- Explosion hazard—do not use in the vicinity of flammable anesthetics.

## Warnings Related to Treatment

- If you stop your PAP or bilevel treatment, your sleep apnea will return immediately.
- Always consult your clinician if you expect to be in a situation where you cannot use your VPAP Auto unit.
- If you are admitted to a hospital or prescribed any other form of medical treatment, always inform the medical staff that you are being treated with PAP or bilevel. It is also important to contact the clinician who is treating you for sleep apnea.
- If you experience an infection of the upper respiratory tract, middle ear, or sinuses, contact your clinician before continuing your PAP or bilevel treatment. You may be advised to stop treatment until the infection has cleared. If you continue with treatment during an infection, be sure to clean your mask and tubing after every use.

## Cautions

- At low pressures, the flow through the exhalation ports of your mask may not clear all exhaled gas from the tubing. Some rebreathing may occur.
- The airflow for breathing produced by this device can be as much as 11°F (6°C) higher than the temperature of the room. Caution should be exercised if the room temperature is warmer than 90°F (32°C).
- When AC mains power (100/240V AC) is not available, always use a ResMed DC-12 converter. (The DC-12 converter is available as an optional accessory.)
- If supplied, the ResScan™ Data Card module is designed for use with specific ResMed devices.
- Only use the ResSan Data Card module (if supplied) as specified in this manual.

**Note:** *The above are general warnings and cautions. Specific warnings, cautions, and notes appear with the relevant instructions in the manual.*

## Adverse Effects

Patients should report unusual chest pain, severe headache or increased breathlessness to their prescribing physician. An acute upper respiratory tract infection may require temporary discontinuation of treatment.

The following side effects may arise during the course of therapy with the device:

- drying of the nose, mouth or throat
- nosebleed
- bloating
- ear or sinus discomfort
- eye irritation
- skin rashes
- chest discomfort.



# The VPAP Auto System

Please refer to the illustrations in section **A** of the illustration sheet.

## **Front view (A-1)**

Shows the keypad and LCD screen, and the air outlet.

## **Rear view (A-2)**

Shows where the module attaches, and the location of the air filter and power sockets.

## **Power cord (A-3)**

Power cord to attach the VPAP Auto to the AC (mains) power.

## **Travel bag (A-4)**

## **Air tubing (A-5)**

The 6'6" (2 m) air tubing connects the VPAP Auto to your mask.

## Mask

You will also need a **ResMed mask system** (supplied separately). The following ResMed mask systems are recommended for use with the VPAP Auto:

### **Nasal Masks**

- Mirage Vista™ Nasal Mask
- Ultra Mirage™ Nasal Mask
- Ultra Mirage™ II Nasal Mask
- Mirage Activa™ Nasal Mask.

### **Nasal Pillows Systems**

- Mirage Swift™ Nasal Pillows System
- Mirage Swift™ II Nasal Pillows System.

### **Full Face Masks**

- Mirage™ Liberty Full Face Mask
- Mirage™ Quattro Full Face Mask
- Ultra Mirage™ Full Face Mask.

### **Notes:**

- *Not all masks are available in all regions.*
- *ResMed devices have been designed and manufactured to provide optimum performance using ResMed vented mask systems. Other mask systems may be used, however performance and data outputs may be affected.*
- *In VAuto mode, only ResMed masks are compatible for use with the VPAP Auto.*
- *Your clinician needs to set up your VPAP Auto for use with your particular mask.*

## Humidifier

Please refer to the illustration in section **B** of the illustration sheet.

A humidifier may be required if you are experiencing dryness of the nose, throat, or mouth. The VPAP Auto is compatible for use with the HumidAire 3i heated humidifier (B).



## **WARNING**

Only the HumidAire 3i is compatible for use with the VPAP Auto. Please refer to Warnings on page 3.

## **Accessories**

*Please refer to the illustrations in section C of the illustration sheet.*

The following accessories are available for use with the VPAP Auto:

- ResScan Data Card (C-1)
- ResScan Data Card module (C-2)
- Blank module (C-3)
- DC-12 converter (C-4)
- Air tubing 9'10" (3 m) (C-5).

**Note:** ResMed recommends the following tubing products for use with the VPAP Auto: 9' 9" (3 m) air tubing, gray (PN: 14980); 6' 6" (2 m) air tubing, gray (PN: 14948); disposable air tubing, clear (PN: 14912).

## **Supplemental Oxygen**

The VPAP Auto is designed to be compatible with the use of low flow oxygen therapy provided from an external source. At a fixed flow rate of supplemental oxygen flow, the inhaled oxygen concentration will vary, depending on the pressure settings, patient breathing pattern, mask selection, and the leak rate. This warning applies to most types of PAP machines.

# Preparing for Use

## Setting Up the VPAP Auto

- 1 Place the VPAP Auto on a table near the head of your bed.



### CAUTION

Be careful not to place the device where it can be bumped or where someone is likely to trip over the power cord.

*Note: You can also place your VPAP Auto on the floor beside or underneath your bed. Ensure that the area is free from dust and clear of bedding, clothes or any other objects that could block the air inlet.*

- 2 Connect the power cord to the socket at the rear of the flow generator (**D-1**). Plug the other end of the power cord into the power outlet.



### WARNING

Make sure the power cord and plug are in good condition and the equipment is not damaged.

- 3 Connect one end of the air tubing firmly onto the air outlet (**D-2**).



### WARNING

- Only ResMed air tubing should be used with your flow generator. A different type of air tubing may alter the pressure you actually receive, reducing the effectiveness of your treatment.
- Blocking the air inlet or tubing while in operation could lead to overheating of the device.
- In the clinical environment any personal computer that is used with your CPAP system must be at least 5' (1.5 m) away from, or at least 8' (2.5 m) above, the patient. It must also comply with the relevant test standard. For personal computers the international standard is IEC 60950 or equivalent.

## Assemble the Mask

- 1 Assemble your mask system according to the mask user instructions.
- 2 Connect your mask system to the free end of the air tubing (**D-3**).
- 3 Check that the mask setting on the MASK screen is the one recommended for the mask you are using (see the table in "How to Select the Mask Type" on page 18).

The VPAP Auto is now ready for use (**D-4**).



## Humidifier Use

Please refer to the illustration in section **E** of the illustration sheet, and your HumidAire 3i manual.



### **WARNING**

The VPAP Auto is not compatible with external humidifiers.

### **HumidAire 3i humidifier**

The HumidAire 3i attaches to the front of the VPAP Auto to provide heated humidification. No other accessories are required for its use. The VPAP Auto automatically detects the presence of the HumidAire 3i. No menu changes are required. Please refer to the relevant user manual for details.



### **WARNING**

- Make sure that the water chamber is empty and thoroughly dried before transporting the HumidAire 3i.
- When using the travel bag, always separate the VPAP Auto unit and the HumidAire 3i and place the HumidAire 3i in its pouch.

The VPAP Auto is now ready for use. To start treatment, see “Operating Instructions” on page 15.

# Features of the VPAP Auto

The control panel of the VPAP Auto unit includes a keypad for navigating through the menus and delivering treatment.

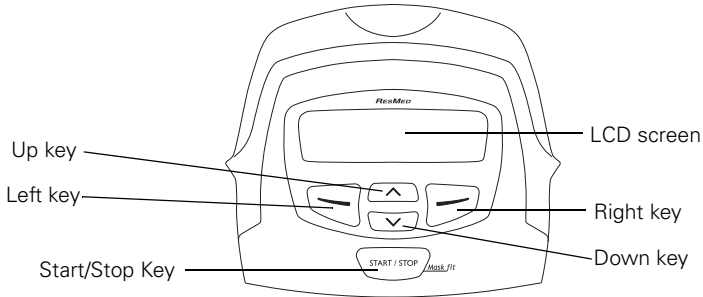







**Figure 1: VPAP Auto Keypad and LCD**

The LCD is used to display the menus and other data. The arrows and lowercase text on the bottom line of the LCD prompt the use of the keys within the menus. The keypad is used to navigate through the menus, access the mask-fit feature, and start/stop treatment. The functions of the keys and quick key combinations are listed in Table 1.

The LCD backlight turns off after two minutes of inactivity. It turns back on when you press a key.

**Table 1: Keys on the front panel and their functions**

Key	Function
<b>LCD screen</b> 	<ul style="list-style-type: none"> <li>Displays VPAP Auto information including the menus and treatment screens.</li> </ul>
<b>Start/Stop</b> 	<ul style="list-style-type: none"> <li>Starts or stops treatment.</li> <li>Extended hold for at least three seconds starts the mask-fit feature.</li> </ul>
<b>Up</b> 	<ul style="list-style-type: none"> <li>Allows you to scroll through the VPAP Auto menus and submenus, and increase the settings options.</li> </ul>
<b>Down</b> 	<ul style="list-style-type: none"> <li>Allows you to scroll through the VPAP Auto menus and submenus, and increase the settings options.</li> </ul>

Key	Function
Left 	<ul style="list-style-type: none"> <li>Performs the function indicated by the guiding text displayed above it on the LCD screen. Guiding text includes <b>menu</b>, <b>change</b> and <b>apply</b>.</li> </ul>
Right 	<ul style="list-style-type: none"> <li>Performs the function indicated by the guiding text displayed above it on the LCD screen. Guiding text includes <b>exit</b> and <b>cancel</b>.</li> </ul>

To assist you in adjusting the VPAP Auto, the keypad and LCD are equipped with a backlight. The LCD backlight comes on when the unit is turned on or when you press a key, and turns off after two minutes. The keypad backlight is on at all times when the VPAP Auto is powered.

## Using the Menus

The VPAP Auto unit provides a set of functions which are arranged in menus and submenus. Via the LCD screen, the menus and submenus allow you to view and change the settings for a particular function. You can access the menus regardless of whether the VPAP Auto is in standby mode or delivering therapy. After the Welcome screen appears and device self-checks are complete, you will see either the Ramp screen (S mode and CPAP mode) or the Settling screen (VAuto mode).

### Ramp Screen

(S mode, CPAP mode) If your clinician has set a maximum ramp time, the Ramp screen is displayed after the Welcome screen. On the Ramp screen, you can immediately set a ramp time. Ramp time is the period during which the pressure increases from a low pressure to the prescribed treatment pressure. See “Ramp Time” on page 18.

Ramp time can be altered in five-minute increments (from OFF to a maximum ramp time set by your clinician) by the using the **Up/Down** key.

### Settling Screen

(VAuto mode) If your clinician has set a maximum settling time, the Settling screen is displayed after the Welcome screen. On the Settling screen, you can immediately set a settling time. Settling time is the period for which the device remains at Min EPAP (with an inspiratory pressure determined by Pressure Support on top of Min EPAP). See “Settling Time” on page 18.

Settling time can be altered in five-minute increments (from OFF to a maximum settling time set by your clinician) by the using the **Up/Down** key.

## Menus

The menu allows you to view details about the time used and the current software version of your VPAP Auto. The Used (time) screen displays the total number of hours for which you have used the device since it was last reset by the clinician. It also displays the number of days the VPAP Auto was used out of

the total number of days available for use. The SW screen displays the current software version that is installed in your VPAP Auto.

Figure 2 summarizes the VPAP Auto standard menu series.

- To access the VPAP Auto menus:  
Press the **Left** key (menu) while the VPAP Auto (or Ramp or Settling) screen is displayed.
- To scroll through items within the menu:  
Press the **Up/Down** key
- To exit out of the menu:  
Press the **Right** key (exit)

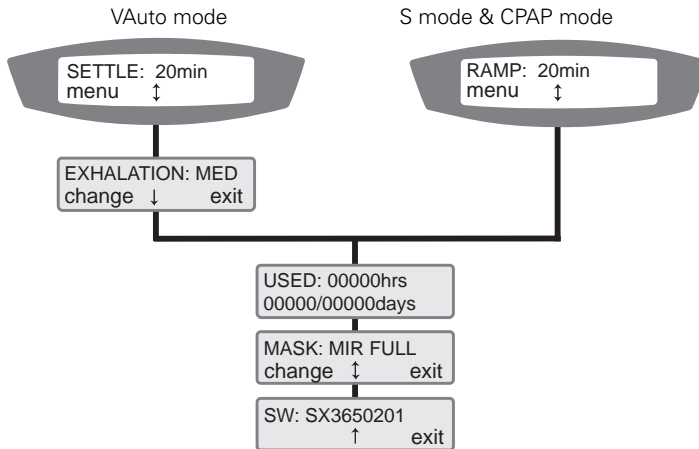

Figure 2: VPAP Auto Menu Series

**Note:** The Exhalation screen is only available if enabled by a clinician.

### Menus with a Humidifier

If the HumidAire 3i is connected to the VPAP Auto, and treatment has not commenced, the VPAP Auto will display one of the following screens:



Figure 3: Patient Menu display with humidifier: prior to starting treatment

After treatment starts, the treatment screen displays (see Figure 5, Treatment screens (all modes), on page 17).

## Menus with a ResLink and Oximeter

If your clinician has recommended that you use a ResLink module, and the ResLink and an oximeter are connected to the VPAP Auto, then display of SpO<sub>2</sub> (oxygen saturation) and HR (heart rate) takes priority. If treatment has not commenced, the VPAP Auto will display one of the following screens, whether a humidifier is connected or not:

Prior to starting treatment:

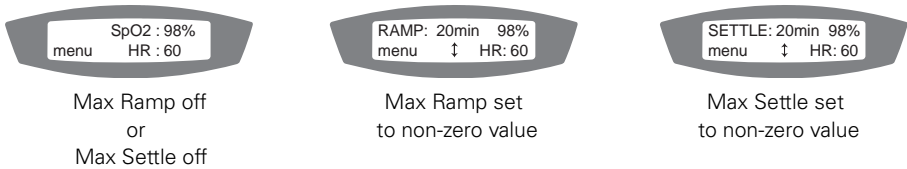

Figure 4: Menu display with ResLink and oximeter

### Accessing the Menus

To navigate and make selections within the Patient Menu, use:

- the **Up/Down** key to scroll through items within a level
- the **Left** key to enter a submenu and to apply an option choice
- the **Right** key to navigate out of a menu or submenu and to exit without changing options.

**Oxygen saturation (SpO<sub>2</sub>):** The saturation of blood hemoglobin (%).

**Heart rate (HR):** The number of heartbeats in a 60-second time frame (beats per minute).

# Operating Instructions

## Starting Treatment

The VPAP Auto unit should be assembled beside your bed with the air tubing and mask system connected. See “Setting Up the VPAP Auto” on page 9.

- 1 Plug the power cord into the power source. A welcome message is displayed on the LCD screen. The Ramp or Settling screen then appears.

**Note:** *If you have the HumidAire 3i attached, please refer to the relevant user manual for operating instructions.*

- 2 Fit your mask as described in the mask user instructions.
- 3 Lie down and arrange the air tubing so that it is free to move if you turn in your sleep.
- 4 To start treatment, simply breathe into the mask (see “SmartStart™”). Air will begin flowing slowly and will build up to full operating pressure in about 10 to 15 seconds.

**Note:** *If the VPAP Auto does not start automatically, you can also press the **Start/Stop** key.*

## SmartStart™

The VPAP Auto has a function called SmartStart™. SmartStart enables your device to start automatically when you breathe into your mask. If your clinician has enabled SmartStop, your device will stop automatically when you take your mask off.

## Stopping Treatment

To stop treatment at any time, remove your mask and press the **Start/Stop** key or  
if your clinician has enabled SmartStop, simply remove your mask and treatment will end.

**Note:** *SmartStop will not work if:*

- *You have selected MIR FULL for your mask type.*
- *Your clinician has enabled Leak Alert.*

## Using the Mask-Fitting Feature

You can use the VPAP Auto mask-fitting feature to help you fit your mask properly. This feature delivers air pressure for a three-minute period, prior to starting treatment, during which you can check and adjust your mask fit to minimize leaks.

**Note:** Make sure that the mask setting on the MASK screen is the same as the mask you are using.

To use the mask-fitting feature:

- 1 Fit your mask as described in the mask user instructions.
- 2 Hold down the **Start/Stop** key for at least three seconds until air pressure delivery starts.

The following display will appear on the LCD screen indicating that the mask-fitting feature is operating. Your device will ramp to the mask-fit pressure and will remain at this pressure for three minutes.

The LCD also displays a mask-fit star rating. See Table 2.



**Notes:**

- The mask-fit star rating display disappears after three minutes.
- The mask-fitting feature can only be started from the RAMP or SETTLING screen.
- When the device is in VAuto mode, the mask-fit pressure is 10 cm H<sub>2</sub>O. When the device is in CPAP mode, the mask-fit pressure is the set treatment pressure or 10 cm H<sub>2</sub>O, whichever is greater. When the device is in S mode, the mask-fit pressure is EPAP or 10 cm H<sub>2</sub>O, whichever is greater.
- Leak Alert and SmartStop functions are disabled while using Mask Fit.

- 3 Adjust your mask, mask cushion and headgear until you have a secure and comfortable fit.

Once you have a secure and comfortable fit, check your mask-fit star rating on the LCD screen. Table 2 explains the mask-fit star ratings.

**Note:** If there is another person nearby to check your mask-fit star rating, you can adjust your mask, mask cushion and headgear while lying down.

Table 2: Definitions of Mask-Fit Star Rating

Star rating	Definition
*****	Excellent
****_	Very good
***__	Good
**___	Adjust mask
*____	Adjust mask
_____	Adjust mask

- 4** After three minutes, the pressure reverts to the set pressure and treatment will begin.
- If you do not wish to wait three minutes, hold down the **Start/Stop** key for at least three seconds to start treatment immediately.
  - If you press the **Start/Stop** key for less than three seconds, the device will return to standby mode (the RAMP or SETTling screen is displayed).

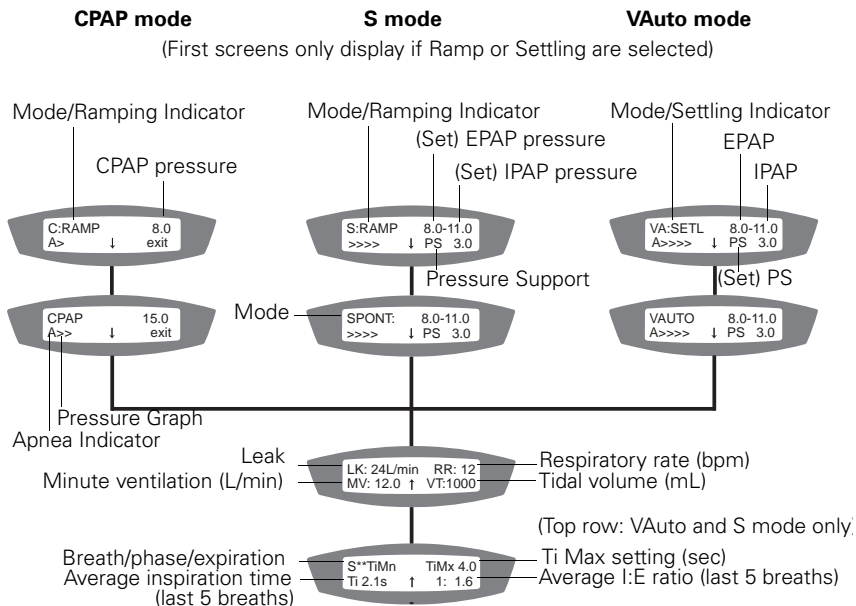

**Note: (Set) values are those selected by the clinician.**

Figure 5: Treatment screens (all modes)

The treatment screens contain the following information:

**Treatment mode:** Mode of treatment set by your clinician. Options are: CPAP, S and VAuto.

**Ramping indicator:** (CPAP mode, S mode) Appears if the VPAP Auto is in ramp mode. This disappears once the ramp time has elapsed.

**Settling indicator:** (VAuto mode) Appears if the VPAP Auto is in settling mode. This disappears once the settling time has elapsed.

**Set pressure(s):** In CPAP mode, this displays the set treatment pressure (centimeters of water). In S mode, it displays exhalation and inhalation pressures (centimeters of water). In VAuto mode, it displays the EPAP and IPAP pressures (centimeters of water).

**Apnea indicator:** (CPAP mode, VAuto mode) Visual indicator that displays an "A" to indicate an apnea is occurring.



**Pressure bar graph:** Graphical display of the changing pressure.

**Leak:** Current mask leak (liters per minute).

**Respiratory rate:** Number of breaths per minute.

**Minute ventilation:** Volume of air inhaled per minute (liters per minute).

**Tidal volume:** Volume of air inhaled per breath (milliliters per breath).

**Breath/phase/expiration:** This screen item displays in the format: breath type/phase display/expiration type as shown below (eg, S\*\*TiMn):

Breath type: S=spontaneous

Phase display: \*\*=inspiration, (blank)=expiration

Expiration type:

TiMn=expiration triggered at completion of minimum inspiration-hold time

TiMx=expiration triggered at completion of maximum inspiration-hold time

C=expiration triggered spontaneously within Ti Min and Ti Max

## Ramp Time

**(S mode, CPAP mode)** Ramp time is a feature which can be enabled by your clinician. If you have difficulty falling asleep with full pressure, select a ramp time. The airflow will start very gently while you fall asleep. The pressure will slowly increase to full operating pressure over the selected ramp time. The clinician has set a maximum ramp time; you may select any value up to the maximum.

## Settling Time

**(VAuto mode)** Settling time is a feature which can be enabled by your clinician. If you have difficulty falling asleep with the VPAP Auto operating, select a settling time. The airflow will remain at Minimum Pressure for the period of time that you set, giving you time to fall asleep. After this time, the VPAP Auto will be able to increase pressure in response to events.

The clinician will set a maximum settling time; you may select any value up to the maximum.

## How to Select the Mask Type

Scroll to MASK and select **Change** (Left key). Press the **Up** or **Down** keys until you see the mask type that you require.

The following table shows the setting that should be selected for each mask type.

Table 3: Settings for mask types

Settings	Mask
ULTRA	Ultra Mirage Nasal Mask Ultra Mirage II Nasal Mask
MIR FULL	Mirage Liberty Full Face Mask Mirage Quattro Full Face Mask Ultra Mirage Full Face Mask
ACTIVA	Mirage Activa Nasal Mask
SWIFT	Mirage Swift Nasal Pillows System Mirage Swift II Nasal Pillows System
STANDARD	Mirage Vista Nasal Mask

## Messages on the VPAP Auto LCD

Your clinician may have set your VPAP Auto to remind you about important events, such as when to replace your mask, when to insert your Data Card (if your device is Data Card enabled) and so on.

The reminder message is displayed on the LCD and is visible if the device is not delivering therapy. The backlight on the LCD flashes when a message is displayed.

Your clinician can set any of the following reminders on your LCD:

Message	Description	Action
INSERT CARD	May appear if your device is Data Card enabled.	Insert your Data Card (see Section <b>H</b> of the illustrations sheet) and follow any instructions that your clinician has given you. When you have done this, the message will disappear from the LCD. Pressing the <b>Left</b> (Ok) key will also remove the message.
REPLACE MASK	May appear when your mask is due for replacement.	Press the <b>Left</b> (Ok) key to remove the message from your LCD, and replace your mask with a new one.
CALL PROVIDER*	May appear as a reminder to contact your clinician; for example to discuss how your therapy is going.	Press the <b>Left</b> (Ok) key to remove the message from your LCD, and contact your clinician.

Message	Description	Action
REPLACE FILTER	May appear as a reminder to replace the air filter on your device.	Press the <b>Left</b> (Ok) key to remove the message from your LCD, and replace the air filter.
SERVICE DUE	May appear as a reminder to return your device for service.	Press the <b>Left</b> (Ok) key to remove the message from your LCD.
Customized messages	Your clinician may also set reminders for other reasons; for example to return equipment or to call a particular person or number.	Press the <b>Left</b> (Ok) key to remove the message from your LCD.

## Modules

**Note:** Do not remove modules while power is connected to the VPAP Auto. Your VPAP Auto will have one of two modules fitted to the back: a blank module or a ResScan Data Card module.

### Using a Blank Module

Please refer to the illustrations in section **F** of the illustration sheet.

The blank module is a protective cover on your VPAP Auto. At times, you may wish to remove or attach the module, for example to use another module.

To remove the blank module, pull it off the back of the VPAP Auto to show the data communications port (**F-1**).

To attach the blank module, push the blank module onto the data communications port, until the module clicks into place (**F-2**).

**Note:** To protect the data communications port, always ensure there is a module attached to the back of the device.

### Using a ResScan Data Card Module

Please refer to the illustrations in section **G** of the illustration sheet.

The ResScan Data Card module is an accessory to the VPAP Auto. Use a ResScan Data Card with the Data Card module to collect data and update settings in the VPAP Auto. The module and card give your clinician convenient access to data about your treatment, and can provide you with new device settings from your clinician without your having to leave home.

## Attaching the Module

To attach the Data Card module, push it onto the data communications port at the back of your VPAP Auto until it clicks into place **(G-1)**.

## Removing the Module

To remove the Data Card module, pull it off the back of the VPAP Auto **(G-2)**.

**Note:** To protect the data communications port, always ensure there is a module attached to the back of the device.

## Using the Data Card to Collect Data

Please refer to the illustrations in section **H** of the illustration sheet.

If your clinician needs to review your treatment, they will ask you to use the Data Card to copy data from your VPAP Auto, and to return the card to them. The Data Card will be provided in a convenient mailback envelope.

Data is copied onto the Data Card when it is inserted into the device. The original data will remain stored on the device.

It takes up to 30 seconds to copy data onto the Data Card.

### 1 Insert the Data Card

- Switch on the VPAP Auto and wait until you see the standby (RAMP or SETTling) screen.
- Hold the Data Card with the arrow facing up, and insert it into the slot in the Data Card module **(H-1)**.
- Push the card in smoothly until it stops moving **(H-2)** and messages start appearing on the LCD.

### 2 Copy data onto the Data Card

- Data copying starts automatically when the Data Card is inserted into the Data Card module.
- The "Card Inserted Please Wait" message is displayed on the VPAP Auto LCD while data is being copied. Copying takes up to 30 seconds.
- The "Copy Complete Remove Card" message is displayed on the LCD when copying has finished.
- Remove the Data Card from the Data Card module. No additional data is copied onto the card once the "Copy Complete Remove Card" message is displayed, even if the card is left in the device. To add additional data to the Data Card, reinsert the card and repeat these steps.

### 3 Remove the Data Card

Grip the end of the Data Card and pull it out of the Data Card module **(H-3)**.

### 4 Store the Data Card

Your Data Card should be stored in its mailback envelope when not in use.

### 5 Mail the Data Card to your clinician

When mailing the Data Card to your clinician:

1. Insert the Data Card into the pocket provided on the mailback envelope. Fold up the mailback envelope.

2. Place the mailback envelope containing the Data Card in a postal envelope and seal it.
3. Make sure that your clinician's name and address details are on the postal envelope, and mail it back immediately.

## Using the Data Card to Update Settings

If your clinician has provided a Data Card with new device settings:

- With the device in standby (RAMP or SETTLING) mode, insert the Data Card into the slot on the Data Card module. Updating will start automatically.
- The "Card Inserted Please Wait" message is displayed on the LCD while updating is in progress. Updating takes up to 30 seconds.
- The "Settings Success Remove Card" message is displayed on the LCD if the settings were updated successfully.

**Note:** *This message only appears once. If you re-insert the Data Card after you have updated your settings, this message is not displayed.*

- Remove the Data Card from the Data Card module.
- Store the Data Card in its mailback envelope when not in use.



### **WARNING**

If your clinician has told you to use this Data Card to update the settings on your device and the "Settings Success" message does not appear, contact your clinician immediately.

## Helpful Hints

### Starting Out

#### **Mouth Leaks**

When using a nasal mask, try to keep your mouth closed during treatment. Air leaks from your mouth can decrease the effectiveness of your treatment. If mouth leaks are a problem, a full face mask or chin strap may help. Contact your clinician or equipment supplier for further details.

#### **Mask-Fitting**

The flow generator delivers the most effective treatment when the mask is well fitted and comfortable. Treatment can be affected by leaks, so it is important to eliminate any leaks that may arise.

If you have problems trying to get a comfortable mask fit, contact your sleep clinic or equipment supplier. You may benefit from a different mask size.

You can also use the Mask-Fitting feature to help you fit your mask properly. See "Using the Mask-Fitting Feature" on page 15.

Before wearing your mask, wash your face to remove excess facial oils. This will allow a better fit and prolong the life of the mask cushion.

## Nasal Irritation

### Dryness

You may experience dryness of the nose, mouth, and/or throat during the course of treatment, especially during winter. In many cases, a humidifier may resolve this discomfort. Contact your clinician for advice.

### Runny or Blocked Nose

You may experience sneezing and/or a runny or blocked nose during the first few weeks of treatment. In many cases, nasal irritation can be resolved with a humidifier. Consult your clinician for advice.

## Use with DC Power

You must use a ResMed DC-12 converter to connect the VPAP Auto to a 12 V or 24 V DC power source. Contact your equipment supplier or ResMed for details.



### WARNING

The device should not be connected to both AC and DC power sources simultaneously.

## Traveling with the VPAP Auto

### International Use

Your VPAP Auto flow generator has an internal power adapter that enables it to operate in other countries. It will operate on power supplies of 100–240V and 50–60Hz. No special adjustment is necessary, but you may need a plug adapter for the region for which you are using the device.

### Use on an Aircraft

Please consult the medical services department of your carrier if you intend to use your VPAP Auto on an aircraft. The VPAP Auto complies with US FCC Part 15, Class B requirements if no external data cables are used.

**Note:** *You should not use your VPAP Auto while the aircraft is taking off or landing.*



# Cleaning and Maintenance

You should regularly carry out the cleaning and maintenance described in this section. Refer to your mask manual for detailed instructions.

## Daily Cleaning

### Mask

Clean the mask according to the instructions supplied with the mask.

### Air tubing

Disconnect the air tubing from the VPAP Auto (and humidifier, if used) and hang the tubing and mask in a clean, dry place until next use.

### Humidifier

If you are using a humidifier, clean it according to the instructions in the humidifier user's manual.

## Weekly Cleaning

1. Remove the air tubing from the VPAP Auto *and* the mask.
2. Wash the air tubing in warm water using mild detergent. Rinse thoroughly, hang, and allow to dry.
3. Before next use, assemble the mask and headgear according to the user instructions.
4. Reconnect the air tubing to the air outlet and mask.

## Periodic Cleaning

1. Clean the exterior of the VPAP Auto with a damp cloth and mild liquid soap.
2. Check the air filter for blockage or holes (see "Replacing the Air Filter" on page 26).



### **WARNING**

- Beware of electric shock. Do not immerse the unit or power cord in water. Always unplug the unit before cleaning and be sure it is dry before plugging back in.
- The mask system and air tubing are subject to normal wear and tear. Inspect them regularly for damage.



## Replacing the Air Filter

To replace the air filter:

1. Remove the air filter cover at the back of the VPAP Auto.

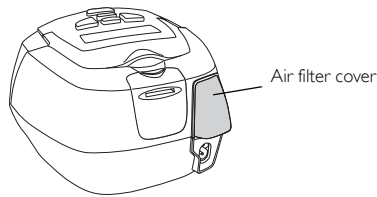

2. Remove and discard the old air filter.
  3. Insert a new filter with the blue tinted side facing out from the device.
  4. Replace the air filter cover.
- Inspect the air filter every month to check if it is blocked by dirt or contains holes. With normal use of an VPAP Auto, the air filter needs to be replaced every six months (or more often if your device is in a dusty environment).



### **WARNING**

- Do not wash the air filter. The air filter is not washable or reusable.
- The air filter cover protects the device in the event of accidental liquid spillage onto the device. Ensure the air filter and air filter cover are fitted at all times.

## Servicing



### **CAUTION**

- Do not attempt to open the VPAP Auto case. There are no user serviceable parts inside.
- Inspection and repair should only be performed by an authorized agent. Under no circumstances should you attempt to service or repair the flow generator yourself.

This product (VPAP Auto) should be inspected by an authorized ResMed service center 5 years from the date of manufacture. Prior to this, the device is intended to provide safe and reliable operation provided that it is operated and maintained in accordance with the instructions provided by ResMed. Applicable ResMed warranty details are provided with the device at the time of original supply. Of course, as with all electrical devices, if any irregularity becomes apparent, you should exercise caution and have the device inspected by an authorized ResMed service center.

If you feel that your flow generator is not performing properly, see "Troubleshooting" on page 27.

# Troubleshooting

If there is a problem, try the following suggestions. If the problem cannot be solved, contact your equipment supplier or ResMed. Do not attempt to open the device.

Problem	Possible Cause	Solution
<i>No display.</i>	Power not connected.	Ensure the appropriate power cord is connected to your VPAP Auto and the power switch (if available) is on.
<i>Insufficient air delivered from VPAP Auto</i>	Ramp or settling time is in use.	Wait for air pressure to build up or change ramp or settling time.
	Air filter is dirty.	Replace air filter.
	Air tubing is kinked or punctured.	Straighten or replace tubing.
	Air tubing not connected properly.	Check air tubing.
	Mask and headgear not positioned correctly.	Adjust position of mask and headgear.
	Cap(s) missing from access port(s) on mask.	Replace cap(s).
	Pressure required for treatment may have changed.	See your clinician to adjust the pressure.
<i>VPAP Auto does not start when you breathe into the mask.</i>	Power cord not connected properly.	Connect power cord firmly at both ends.
	Power outlet may be faulty.	Try another power outlet.
	Breath is not deep enough to trigger SmartStart.	Take a deep breath in and out through the mask.

Problem	Possible Cause	Solution
	There is excessive leak.	Adjust position of mask and headgear.  Caps may be missing from ports on mask. Replace them.  Air tubing not connected properly. Connect firmly at both ends.  Air tubing kinked or punctured. Straighten or replace.
<i>VPAP Auto unit does not stop when you remove your mask.</i>	SmartStop is disabled. <i>Note: SmartStop is not available if you are using a full face mask or if Leak Alert is enabled.</i>	Enable SmartStop if possible.
<i>SmartStop is enabled but the flow generator does not stop automatically when you remove your mask.</i>	Incompatible humidifier or mask system being used.	Use only equipment as recommended and supplied by ResMed.
<i>Pressure rises inappropriately.</i>	Talking, coughing, voluntarily breath-holding (eg while rolling over in bed), or intentionally breathing in an unusual manner.  Mask cushion is buzzing against the skin. Cushion seated incorrectly.  Cushion seated incorrectly causing excessive leak.  Air tubing is kinked or punctured.  Humidifier control dial set too high, resulting in accumulation of water in the air tubing.	Avoid talking with a nasal mask on, and breathe as normally as possible.  Adjust the headgear.  Adjust headgear or re-fit cushion.  Straighten or replace air tubing.  Turn humidifier control dial down and empty the water from the air tubing.

Problem	Possible Cause	Solution
<p><i>Display error message:</i> <b>Check tube!!</b> <b>Key if done</b></p>	The air tubing is loose or blocked.	<p>Check that the air tubing is connected securely to your mask and the air outlet on the front of the VPAP Auto. When you have checked the air tubing, press the Start/Stop key to restart the device. If this does not clear the message, disconnect the power cord and then reconnect it to restart the device.</p>
<p><i>Display error message:</i> <b>SYSTEM ERRnnnn</b> <b>Call Service!</b></p>	Component failure.	Record error number and contact your ResMed service center.
<p><i>Display error message:</i> <b>HIGH LEAK!!!</b> <b>Adjust Mask</b></p>	You have experienced excessively high leak levels for more than 20 seconds.	<p>Check that your air tubing is connected properly and that your mask does not leak excessively. Use the mask-fitting feature to help you to fit your mask properly. If this message appears again, contact your clinician.</p>
<p><i>Display error message:</i> <b>Exxxx</b> (where <b>xxxx</b> defines an error)</p>	Component failure.	Return your VPAP Auto for servicing.
<p><i>The following message is displayed on the LCD after you try to update settings using the Data Card:</i> <b>Card Error</b> <b>Remove Card</b></p>	The Data Card is not inserted correctly.	Ensure that the Data Card is inserted with the arrow facing up and pointing towards the device. Ensure that the device is switched on and in standby mode before you insert the Data Card.
	The Data Card is only partly inserted.	Ensure that the Data Card is inserted into the slot on the Data Card module as far as it will go.
	You may have removed the Data Card before settings were copied to the VPAP Auto.	Reinsert the Data Card and wait for the <b>Settings Success Remove Card</b> message to appear on the LCD.

Problem	Possible Cause	Solution
	The card is not a ResScan Data Card.	Only use a ResScan Data Card.
<i>The following message is displayed on the LCD after you try to copy data to a Data Card:</i> <b>Card Error Remove Card</b>	The Data Card is not inserted correctly.  The card is not a ResScan Data Card.  You may have removed the Data Card before data was copied to it.	Ensure that the Data Card is inserted with the arrow facing up and pointing toward the device.  Use a ResScan Data Card, as specified in this manual.  Reinsert the Data Card and wait for the <b>Copy Complete Remove Card</b> message to appear on the LCD.
<i>The following message is displayed on the LCD after you try to update the settings using the Data Card:</i> <b>Settings Invalid Remove Card</b>	The identification details on the Data Card do not match the details on your device.	Contact your clinician immediately.
<i>The following message is displayed on the LCD after you try to update the settings using the Data Card:</i> <b>Settings Error Remove Card</b>	There is a data error on the Data Card.	Contact your clinician immediately.
<i>The following message is NOT displayed on the LCD after you try to update the settings using the Data Card:</i> <b>Settings Success Remove Card</b>	The settings were not updated.	Contact your clinician immediately.

# Technical Specifications

## Performance

Operating pressure range: 3 to 20 cm H<sub>2</sub>O

Maximum single fault pressure: 30 cm H<sub>2</sub>O

Pressure measurement tolerance:  $\pm 0.5$  cm H<sub>2</sub>O  $\pm 4\%$  of the measured reading

Flow measurement tolerance:  $\pm 0.1$  or 20% of reading, whichever is greater.

## Dynamic pressure characteristics

**VAuto mode:** 4 to 20 cm H<sub>2</sub>O (measured at the mask); Min EPAP pressure: 4 cm H<sub>2</sub>O; Max IPAP pressure: 20 cm H<sub>2</sub>O; Pressure Support: 0 to 10 cm H<sub>2</sub>O

**S mode:** IPAP: 5 to 20 cm H<sub>2</sub>O (measured at the mask); EPAP: 3 to 20 cm H<sub>2</sub>O (measured at the mask)

**CPAP mode:** 4 to 20 cm H<sub>2</sub>O (measured at the mask)

**Sound pressure level:** Radiated sound pressure is measured at <30 dBA at 10 cm H<sub>2</sub>O and 3'3.37" (1 m) according to ISO17510.

**Dimensions (L x W x H):** 4.4" x 6.5" x 5.7" (112 mm x 164 mm x 145 mm)

**Weight:** 2.9 lb (1.3 kg)

**Power supply:** Input range 100–240V, 50–60Hz, 40VA (typical power consumption), < 100VA (maximum power consumption)

**Housing construction:** Flame retardant engineering thermoplastic

## Environmental conditions

Operating temperature: 41°F to 95°F (+5°C to +35°C)

Operating humidity: 10–95% non-condensing

Storage and transport temperature: -4°F to 140°F (-20°C to +60°C)

Storage and transport humidity: 10–95% non-condensing

Operating Altitude: Sea level to 8500'

## Electromagnetic Compatibility

Product complies with all applicable electromagnetic compatibility requirements (EMC) according to IEC60601-1-2, for residential, commercial, and light industry environments. For further details, see "Guidance and Manufacturer's Declaration—Electromagnetic Emissions and Immunity" on page 34.

## Noise Level

### VPAP Auto—CPAP mode, 10 cm H<sub>2</sub>O set pressure<sup>a</sup>

Measured total A-weighted sound pressure level (dB re 20 µPa)	24 dBA
--	--------

Uncertainty (dB re 20 µPa)	2 dBA
----------------------------	-------

Measured values are determined according to the noise test procedure given in ISO 17510-1.

**Note:** *The sum of a measured noise emission value and its associated uncertainty represents an upper boundary of the range of values that is likely to occur in measurements.*

- Declared dual number noise emission values in accordance with ISO 4871.

**Air filter:** Two-layered, powder-bonded, polyester non-woven fiber

**Air tubing:** Flexible plastic, 1 x 6'6" (2 m) length

**Air outlet:** The 22 mm conical air outlet complies with EN 1281-1

**IEC 60601-1 classification:** Class II (double insulation), Type CF

**Note:** *The manufacturer reserves the right to change these specifications without notice.*

## Accessories

### Data Card

**Dimensions (L x W x D):** 2.56" x 0.87" x 0.03" (65.04 mm x 22.15 mm x 0.85 mm)

### Data Card Module

**Dimensions (H x W x D):** 1.95" x 1.66" x 0.47" (49.7 mm x 42.2 mm x 12 mm)

**Note:** *The manufacturer reserves the right to change these specifications without notice.*

## Symbols which Appear on the Device



Attention, consult accompanying documents



Type CF equipment



Class II equipment



Drip proof



Dangerous voltage



Start/Stop and Mask fit



## Guidance and Manufacturer’s Declaration—Electromagnetic Emissions and Immunity

### Guidance and manufacturer’s declaration—electromagnetic emissions

The VPAP Auto device is intended for use in the electromagnetic environment specified below. The customer or the user of the VPAP Auto device should assure that the device is used in such an environment.

Emissions test	Compliance	Electromagnetic environment—guidance
RF emissions CISPR11	Group 1	The VPAP Auto device uses RF energy only for its internal function. Therefore, its RF emissions are very low and are not likely to cause any interference in nearby electronic equipment.
RF emissions CISPR 11 with serial adapter	Class B*	The VPAP Auto device is suitable for use in all establishments, including domestic establishments and those directly connected to the public low-voltage network that supplies buildings used for domestic purposes.
RF emissions CISPR 11 with USB adapter	Class B	
Harmonic Emissions IEC 61000-3-2	Class A	
Voltage Fluctuations/Flicker Emissions IEC 61000-3-3	Complies	

\* Class B for all system configurations except when a ResLink with oximeter is attached to a VPAP Auto device powered from a DC-12 adapter, in which case the system is Class A compliant. Class A is suitable for use in all establishments other than domestic and those directly connected to a low voltage power supply network which supplies buildings used for domestic purposes.

Medical Electrical Equipment needs special precautions regarding EMC and needs to be installed and put into service according to EMC information provided in this document.

**Warnings:** The VPAP Auto device should not be used adjacent to or stacked with other equipment. If adjacent or stacked use is necessary, the VPAP Auto device should be observed to verify normal operation in the configuration in which it will be used.

The use of accessories (eg humidifiers) other than those specified in this manual is not recommended. They may result in increased emissions or decreased immunity of the VPAP Auto device.

## Guidance and manufacturer's declaration – electromagnetic immunity

The VPAP Auto device is intended for use in the electromagnetic environment specified below. The customer or the user of the VPAP Auto device should assure that the device is used in such an environment.

Immunity test	IEC60601-1-2 test level	Compliance level	Electromagnetic environment – guidance
Electrostatic discharge (ESD) IEC 61000-4-2	±6 kV contact ±8 kV air	±6 kV contact ±8 kV air	Floors should be wood, concrete or ceramic tile. If floors are covered with synthetic material, the relative humidity should be at least 30%.
Electrical fast transient/burst IEC 61000-4-4	±2 kV for power supply lines ±1 kV for input/output lines	±2 kV Not Applicable	Mains power quality should be that of a typical commercial or hospital environment.
Surge IEC 61000-4-5	±1 kV differential mode ±2 kV common mode	±1 kV differential mode ±2 kV common mode	Mains power quality should be that of a typical commercial or hospital environment.
Voltage dips, short interruptions and voltage variations on power supply input lines. IEC 61000-4-11	<5% $U_t$ (>95% dip in $U_t$ ) for 0.5 cycle  40% $U_t$ (60% dip in $U_t$ ) for 5 cycles  70% $U_t$ (30% dip in $U_t$ ) for 25 cycles  <5% $U_t$ (>95% dip in $U_t$ ) for 5 sec	< 12 V (>95% dip in 240V) for 0.5 cycle  96 V (60% dip in 240V) for 5 cycles  168 V (30% dip in 240V) for 25 cycles  <12 V (>95% dip in 240V) for 5 sec	Mains power quality should be that of a typical commercial or hospital environment. If the user of the VPAP Auto device requires continued operation during power mains interruptions, it is recommended that the VPAP Auto device be powered from an uninterruptible power source.
Power frequency (50/60 Hz) magnetic field IEC 61000-4-8	3 A/m	3 A/m	Power frequency magnetic fields should be at levels characteristic of a typical location in a typical commercial or hospital environment.

NOTE:  $U_t$  is the AC mains voltage prior to application of the test level.

*(Continued next page)*

## Guidance and manufacturer's declaration – electromagnetic immunity

The VPAP Auto device is intended for use in the electromagnetic environment specified below. The customer or the user of the VPAP Auto device should assure that the device is used in such an environment.

Immunity test	IEC60601-1-2 test level	Compliance level	Electromagnetic environment – guidance
<p>Conducted RF IEC 61000-4-6</p> <p>Radiated RF IEC 61000-4-3</p>	<p>3 Vrms 150 kHz to 80 MHz</p> <p>10 V/m 80 MHz to 2.5 GHz</p>	<p>3 Vrms</p> <p>10 V/m</p>	<p>Portable and mobile RF communications equipment should be used no closer to any part of the VPAP Auto device, including cables, than the recommended separation distance calculated from the equation applicable to the frequency of the transmitter.</p> <p>Recommended separation distance</p> <p><math>d = 1.17 \sqrt{P}</math></p> <p><math>d = 0.35 \sqrt{P}</math> 80 MHz to 800 MHz</p> <p><math>d = 0.70 \sqrt{P}</math> 800 MHz to 2.5 GHz</p> <p>where P is the maximum output power rating of the transmitter in watts (W) according to the transmitter manufacturer and d is the recommended separation distance in meters (m).</p> <p>Field strengths from fixed RF transmitters, as determined by an electromagnetic site survey,<sup>a</sup> should be less than the compliance level in each frequency range.<sup>b</sup></p> <p>Interference may occur in the vicinity of equipment marked with the following symbol:</p> 

NOTE 1: At 80 MHz and 800 MHz, the higher frequency range applies.

NOTE 2: These guidelines may not apply in all situations. Electromagnetic propagation is affected by absorption and reflection from structures, objects and people.

<sup>a</sup> Field strengths from fixed transmitters, such as base stations for radio (cellular/cordless) telephones and land mobile radios, amateur radio, AM and FM radio broadcast and TV broadcast cannot be predicted theoretically with accuracy. To assess the electromagnetic environment due to fixed RF transmitters, an electromagnetic site survey should be considered. If the measured field strength in the location in which the VPAP Auto device is used exceeds the applicable RF compliance level above, the VPAP Auto device should be observed to verify normal operation. If abnormal performance is observed, additional measures may be necessary, such as reorienting or relocating the VPAP Auto device.

<sup>b</sup> Over the frequency range 150 kHz to 80 MHz, field strengths should be less than 10 V/m.

## Recommended separation distances between portable and mobile RF communications equipment and the VPAP Auto series of devices

The VPAP Auto device is intended for use in an environment in which radiated RF disturbances are controlled. The customer or the user of the VPAP Auto device can help prevent electromagnetic interference by maintaining a minimum distance between portable and mobile RF communications equipment (transmitters) and the VPAP Auto device as recommended below, according to the maximum output power of the communications equipment.

	Separation distance according to frequency of transmitter m		
Rated maximum output power of transmitter W	150 kHz to 80 MHz $d = 1.17 \sqrt{P}$	80 MHz to 800 MHz $d = 0.35 \sqrt{P}$	800 MHz to 2.5 GHz $d = 0.7 \sqrt{P}$
0.01	0.17	0.04	0.07
0.1	0.37	0.11	0.22
1	1.17	0.35	0.7
10	3.69	1.11	2.21
100	11.70	3.50	7.0

For transmitters rated at a maximum output power not listed above, the recommended separation distance  $d$  in metres (m) can be determined using the equation applicable to the frequency of the transmitter, where  $P$  is the maximum output power rating of the transmitter in watts (W) according to the transmitter manufacturer.

NOTE 1: At 80 MHz and 800 MHz, the separation distance for the higher frequency range applies.

NOTE 2: These guidelines may not apply in all situations. Electromagnetic propagation is affected by absorption and reflection from structures, objects and people.



# Limited Warranty

ResMed warrants that your ResMed product shall be free from defects in material and workmanship for the period specified below from the date of purchase by the initial consumer. This warranty is not transferable.

Product	Warranty Period
ResMed humidifiers, ResControl™, ResLink™, ResTraxx™	1 Year
ResMed flow generators	2 Years
Accessories, mask systems (including mask frame, cushion, headgear and tubing). Excludes single-use devices.	90 Days

**Note:** *Some models are not available in all regions.*

If the product fails under conditions of normal use, ResMed will repair or replace, at its option, the defective product or any of its components. This Limited Warranty does not cover:

- a) any damage caused as a result of improper use, abuse, modification or alteration of the product;
- b) repairs carried out by any service organization that has not been expressly authorized by ResMed to perform such repairs;
- c) any damage or contamination due to cigarette, pipe, cigar or other smoke;
- d) any damage caused by water being spilled on or into a flow generator.

Warranty is void on product sold, or resold, outside the region of original purchase. Warranty claims on defective product must be made by the initial consumer at the point of purchase.

This warranty is in lieu of all other express or implied warranties, including any implied warranty of merchantability or fitness for a particular purpose. Some regions or states do not allow limitations on how long an implied warranty lasts, so the above limitation may not apply to you.

ResMed shall not be responsible for any incidental or consequential damages claimed to have occurred as a result of the sale, installation or use of any ResMed product. Some regions or states do not allow the exclusion or limitation of incidental or consequential damages, so the above limitation may not apply to you. This warranty gives you specific legal rights, and you may also have other rights which vary from region to region.

For further information on your warranty rights, contact your local ResMed dealer or ResMed office.

R001-307/2 05 06



# Index

## A

- Accessories 8
- Air filter 7, 27
  - replacing 26
- Air pressure 27
- Air tubing 7
  - cleaning 25
  - connect to air outlet 9
  - kinked 27
- Aircraft 23

## B

- Backlight, LCD and keypad 12

## C

- Cleaning
  - daily 25
  - periodic 25
  - weekly 25
- Cleaning mask 25
- Components 7

## D

- Daily cleaning 25
- Data Card 29
- DC-12 converter 23
- Definitions 1
- Down key 11
- Dryness 23
- Dynamic pressure characteristics 31

## E

- Electromagnetic Compatibility 32
- Error messages 29

## F

- Features of the VPAP Auto 11

## H

- Headgear position 27
- Helpful hints 22
- HumidAire 3i 10
- Humidifier 7, 10
  - cleaning 25
- Humidifier use 10

## I

- International use 23

## K

- Keypad 7

## L

- LCD 7
  - error messages 30
  - messages 19
- Left key 12
- Limited Warranty 39

## M

- Mask 7
  - attaching 9
  - mask fit 16
  - mask type 18
  - port 27
  - position 27
- Mask fit 15
  - star rating 16
- Mask fitting 22
- Mask screen 16
- Mask settings 18
- Mask types 18
- Medical information 3
- Menus 12, 14
  - using 12
  - with humidifier 13
- Modules
  - attaching 7
- Mouth leaks 22

## N

- Nasal irritation 23
- Noise level 32

## O

- Operating instructions 15
- Oxygen
  - supplemental 8

## P

- Periodic cleaning 25
- Power cord 7, 27
  - connecting 9



Power sockets 7  
Power sources 23  
Preparing for use 9  
Pressure, mask-fit 16

## **R**

Ramp screen 12  
Ramp time 12, 18, 27  
Reminders 19

- call provider 19
- customized messages 20
- insert card 19
- replace air filter 20
- replace mask 19
- service due 20

Responsibility, user/owner 1  
Right key 12  
Runny or blocked nose 23

## **S**

Setting up 9  
Settling screen 12  
Settling time 12, 18, 27  
Start/stop key 11  
Starting treatment 17  
Supplemental oxygen 8

## **T**

Technical specifications 31, 32  
Traveling 23  
Troubleshooting 27

## **U**

Up key 11  
Use on aircraft 23  
Used (time) screen 12  
User/owner responsibility 1  
Using the menus 12

## **V**

VPAP Auto

- dimensions 32
- servicing 26

## **W**

Warnings related to treatment 4  
Warranty 39  
Weekly cleaning 25

268108/2 07 08
VPAP Auto
User
<b>AMER</b>

