

**ENGLISH**

# **User Manual**



**Table of contents:**

1. PRECAUTIONS AND SAFETY MEASURES .....	2
1.1. Preliminary instructions .....	2
1.2. During use .....	3
1.3. After use .....	3
1.4. Definition of measurement (overvoltage) category .....	3
2. GENERAL DESCRIPTION .....	4
2.1. Measuring average values and TRMS values .....	4
2.2. Definition of true root mean square value and crest factor .....	4
3. PREPARATION FOR USE .....	5
3.1. Initial checks .....	5
3.2. Instrument power supply .....	5
3.3. Calibration .....	5
3.4. Storage .....	5
4. OPERATING INSTRUCTIONS .....	6
4.1. Instrument description .....	6
4.2. Description of function keys .....	7
4.2.1. A-HOLD and REL $\Delta$ keys .....	7
4.2.2. ENTER and CANCEL keys .....	7
4.2.3. HFR and Hz keys .....	7
4.2.4. RANGE and MODE keys .....	7
4.3. Internal modes of the instrument .....	8
4.3.1. MIN/MAX/AVG measurement .....	8
4.3.2. AutoTest and Manual Test mode .....	8
4.3.3. AC+DC mode .....	8
4.3.4. HFR mode .....	8
4.3.5. STORE and RECALL modes .....	9
4.3.6. Activation/deactivation of the internal functions .....	9
4.3.7. Output DC current generation .....	10
4.3.8. Loop Power and HART 250 $\Omega$ modes .....	10
4.4. Measuring operations .....	11
4.4.1. DC Voltage measurement .....	11
4.4.2. AC Voltage and Frequency measurement .....	12
4.4.3. DC Current measurement .....	13
4.4.4. AC Current and Frequency measurement .....	14
4.4.5. Resistance measurement and Continuity test .....	15
4.4.6. Diode test .....	16
4.4.7. DC current generation .....	17
4.4.8. Simulation of a transducer .....	18
4.4.9. Measuring output DC current from external transducers (Loop) .....	19
5. MAINTENANCE .....	20
5.1. Replacing the batteries and the internal fuses .....	20
5.2. Cleaning the instrument .....	20
5.3. End of life .....	20
6. TECHNICAL SPECIFICATIONS .....	21
6.1. Technical characteristics .....	21
6.1.1. Electrical characteristics .....	23
6.1.2. Considered standards .....	23
6.1.3. General characteristics .....	23
6.2. Environment .....	24
6.2.1. Environmental conditions for use .....	24
6.3. Accessories .....	24
6.3.1. Accessories provided .....	24
7. SERVICE .....	25
7.1. Warranty conditions .....	25
7.2. Service .....	25

## 1. PRECAUTIONS AND SAFETY MEASURES

The instrument has been designed in compliance with directive IEC/EN61010-1 relevant to electronic measuring instruments. For your safety and in order to prevent damaging the instrument, please carefully follow the procedures described in this manual and read all notes preceded by the symbol  with the utmost attention. Before and after carrying out the measurements, carefully observe the following instructions:

- Do not carry out any measurement in humid environments
- Do not carry out any measurements in case gas, explosive materials or flammables are present, or in dusty environments
- Avoid contact with the circuit being measured if no measurements are being carried out
- Avoid contact with exposed metal parts, with unused measuring probes, circuits, etc.
- Do not carry out any measurement in case you find anomalies such as deformation, breaks, substance leaks, absence of display on the screen, etc.
- Pay special attention when measuring voltages higher than 20V, since a risk of electrical shock exists

The following symbols are used in this manual:



Warning: observe the instructions given in this manual; an improper use could damage the instrument or its components



Presence of dangerous voltage ( $\geq 30V$ ): electrical shock hazard



Double-insulated meter



AC voltage or current



DC voltage or current



Connection to earth

### 1.1. PRELIMINARY INSTRUCTIONS

- This instrument has been designed for use in environments of pollution degree 2.
- It can be used for **VOLTAGE** and **CURRENT** measurements on installations with CAT III 1000V and CAT IV 600V.
- Follow the normal safety rules devised to protect the user against dangerous currents and the instrument against incorrect use
- We recommend following the normal safety rules devised by the procedures for carrying out operations on live systems and using the prescribed PPE to protect the user against dangerous currents and the instrument against incorrect use
- In case the lack of warning against the presence of voltage may constitute a danger for the operator always carry out a continuity measurement before carrying out the measurement of the live system to confirm the correct connection and condition of the leads
- Only the leads supplied with the instrument guarantee compliance with the safety standards. They must be in good conditions and be replaced with identical models, when necessary.
- Do not test circuits exceeding the specified voltage limits.
- Do not perform any test under environmental conditions exceeding the limits indicated in § 6.2.1.
- Check that the batteries are correctly inserted.
- Make sure that the LCD display and the switch indicate the same function.

## 1.2. DURING USE

Please carefully read the following recommendations and instructions:



### CAUTION

Failure to comply with the Caution notes and/or Instructions may damage the instrument and/or its components or be a source of danger for the operator.

- Before activating the rotary switch, disconnect the test leads from the circuit under test.
- When the instrument is connected to the circuit under test, do not touch any unused terminal.
- Avoid measuring resistance if external voltages are present. Even if the instrument is protected, excessive voltage could cause a malfunction of the instrument.
- While measuring, if the value or the sign of the quantity being measured remain unchanged, check if the HOLD function is enabled.

## 1.3. AFTER USE

- When measurement is complete, set the rotary switch to OFF to turn off the instrument.
- If the instrument is not to be used for a long time, remove the batteries.

## 1.4. DEFINITION OF MEASUREMENT (OVERVOLTAGE) CATEGORY

Standard "CEI 61010-1: Safety requirements for electrical equipment for measurement, control and laboratory use, Part 1: General requirements" defines what measurement category, commonly called overvoltage category, is. § 6.7.4: Measured circuits, reads:

(OMISSIS)

Circuits are divided into the following measurement categories:

- **Measurement category IV** is for measurements performed at the source of the low-voltage installation.  
*Examples are electricity meters and measurements on primary overcurrent protection devices and ripple control units.*
- **Measurement category III** is for measurements performed on installations inside buildings.  
*Examples are measurements on distribution boards, circuit breakers, wiring, including cables, bus-bars, junction boxes, switches, socket-outlets in the fixed installation, and equipment for industrial use and some other equipment, for example, stationary motors with permanent connection to fixed installation.*
- **Measurement category II** is for measurements performed on circuits directly connected to the low-voltage installation.  
*Examples are measurements on household appliances, portable tools and similar equipment.*
- **Measurement category I** is for measurements performed on circuits not directly connected to MAINS.  
*Examples are measurements on circuits not derived from MAINS, and specially protected (internal) MAINS-derived circuits. In the latter case, transient stresses are variable; for that reason, the standard requires that the transient withstand capability of the equipment is made known to the user.*

## 2. GENERAL DESCRIPTION

HT8100 carries out the following measurements:

- DC and AC+DC TRMS voltage
- DC and AC+DC TRMS current
- Resistance and Continuity test
- AC voltage and current frequency
- Diode test
- Current generation with amplitude up to 24mA DC with display in mA and %
- Generation with selectable ramp outputs
- Output current measurement from transducers (Loop), HART™ 250Ω resistor included
- Simulation of an external transducer

Each of these functions can be selected using the 8-position rotary switch, including an OFF position. The instrument is also equipped with function keys (see § 4.2) and an analogue graphic bar. The selected quantity appears on the LCD display with the indication of the measuring unit and of the enabled functions.

The instrument is also equipped with an automatic display backlighting function (Autobacklight) and with an Auto Power OFF function which automatically switches off the instrument approx. 20 minutes after the last time a function key was pressed or the rotary switch was turned. To switch on the instrument again, turn the rotary switch.

### 2.1. MEASURING AVERAGE VALUES AND TRMS VALUES

Measuring instruments of alternating quantities are divided into two big families:

- AVERAGE-VALUE meters: instruments measuring the value of the sole wave at fundamental frequency (50 or 60 Hz).
- TRMS (True Root Mean Square) VALUE meters: instruments measuring the TRMS value of the quantity being tested.

With a perfectly sinusoidal wave, the two families of instruments provide identical results. With distorted waves, instead, the readings shall differ. Average-value meters provide the RMS value of the sole fundamental wave; TRSM meters, instead, provide the RMS value of the whole wave, including harmonics (within the instrument's bandwidth). Therefore, by measuring the same quantity with instruments from both families, the values obtained are identical only if the wave is perfectly sinusoidal. In case it is distorted, TRMS meters shall provide higher values than the values read by average-value meters.

### 2.2. DEFINITION OF TRUE ROOT MEAN SQUARE VALUE AND CREST FACTOR

The root mean square value of current is defined as follows: *“In a time equal to a period, an alternating current with a root mean square value with an intensity of 1A, circulating on a resistor, dissipates the same energy that, during the same time, would have been dissipated by a direct current with an intensity of 1A”*. This definition results in the numeric expression:

$$G = \sqrt{\frac{1}{T} \int_{t_0}^{t_0+T} g^2(t) dt}$$

The root mean square value is indicated with the acronym RMS.

The Crest Factor is defined as the relationship between the Peak Value of a signal and its

RMS value:  $CF (G) = \frac{G_p}{G_{RMS}}$  This value changes with the signal waveform, for a purely

sinusoidal wave it is  $\sqrt{2} = 1.41$ . In case of distortion, the Crest Factor takes higher values as wave distortion increases.

### **3. PREPARATION FOR USE**

#### **3.1. INITIAL CHECKS**

Before shipping, the instrument has been checked from an electric as well as mechanical point of view.

All possible precautions have been taken so that the instrument is delivered undamaged.

However, we recommend generally checking the instrument in order to detect possible damage suffered during transport. In case anomalies are found, immediately contact the forwarding agent.

We also recommend checking that the packaging contains all components indicated in § 6.3.1. In case of discrepancy, please contact the Dealer.

In case the instrument should be returned, please follow the instructions given in § 7.

#### **3.2. INSTRUMENT POWER SUPPLY**

The instrument is supplied with four 1.5V AA IEC LR6 alkaline batteries, included in the package.

In order to prevent battery discharge, batteries have not been inserted in the instrument. For battery installation, follow the instructions given in § 5.1

When batteries are flat, the symbol  appears on the display. To replace/insert the batteries, see § 5.1

#### **3.3. CALIBRATION**

The instrument has the technical specifications described in this manual. The instrument's performance is guaranteed for 12 months.

#### **3.4. STORAGE**

In order to guarantee precise measurement, after a long storage time under extreme environmental conditions, wait for the instrument to come back to normal condition (see the environmental specifications contained in § 6.2.1 before use).

## 4. OPERATING INSTRUCTIONS

### 4.1. INSTRUMENT DESCRIPTION

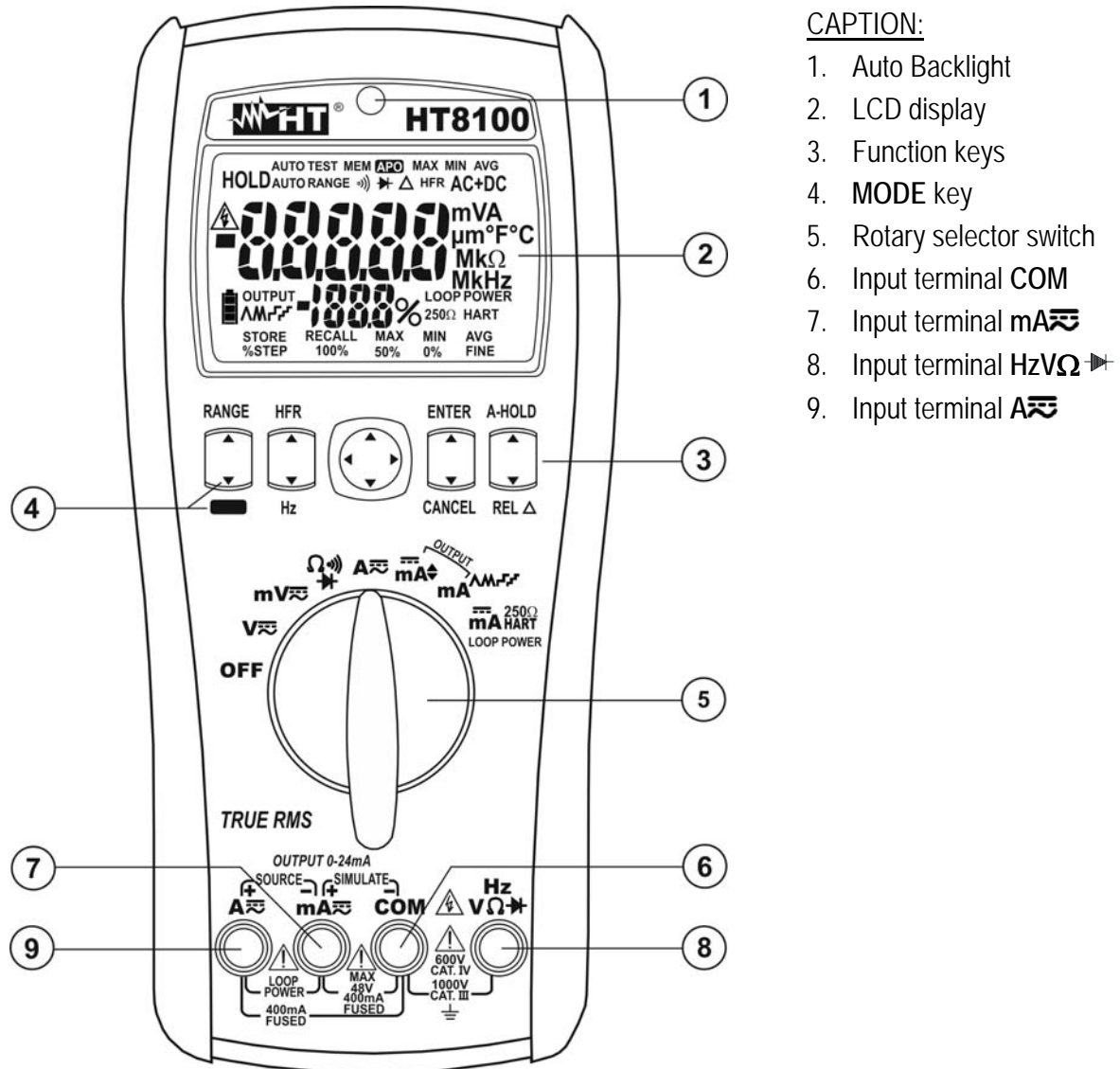

CAPTION:

1. Auto Backlight
2. LCD display
3. Function keys
4. **MODE** key
5. Rotary selector switch
6. Input terminal COM
7. Input terminal mA
8. Input terminal HzVΩ
9. Input terminal A

Fig. 1: Instrument description

## 4.2. DESCRIPTION OF FUNCTION KEYS

The following § describes the functions of the different keys. When pressing a key, the display shows the symbol of the activated function and the buzzer sounds.

### 4.2.1. A-HOLD and REL $\Delta$ keys

- Pressing the **A-HOLD** key in any function, except for the current generation function and diode test function, keeps the value of the measured quantity shown on the display. The message "HOLD" appears on the display. The Auto HOLD function allows the instrument to provide a steady result on the display even with variable input signal (> 50dgt). For readings less than 0.1V (V measure), 1mV (mV measure), no limit (other measures) the A-HOLD feature is not active. Press the **HOLD** key again, the **MODE** key or turn the rotary switch to exit the function.
- Pressing the **REL $\Delta$**  key in any function, except for  $\Omega$ ,  $\rightarrow$ ,  $\rightarrow$ ) measurements and the current generation function, allows carrying out the relative measurement of the quantity to be tested. The symbol " $\Delta$ " appears on the display, initially steady. When pressing the key, the symbol " $\Delta$ " flashes and the value of the quantity being tested is saved as offset for the following measurements. The display shows the relative value, obtained as: relative value (displayed) = current value – offset. Press and hold the **REL $\Delta$**  key for more than 1 second, the **MODE** key, the **RANGE** key or turn the rotary switch to exit the function.

### 4.2.2. ENTER and CANCEL keys

- Pressing the **ENTER** key allows activating a function flashing on the display, selected by means of the 4-arrow selector located on the front panel of the instrument.
- Pressing the **CANCEL** key allows exiting a function flashing on the display, selected by means of the 4-arrow selector located on the front panel of the instrument, thus going back to real time measurement.

### 4.2.3. HFR and Hz keys

- Pressing the **HFR** key, which can be used in positions **V $\sim$** , **mV $\sim$**  and **A $\sim$** , allows activating AC voltage or current measurement in "HFR" mode (see § 4.3.4). Press the **HFR** key or turn the rotary switch to exit the function.
- Pressing the **Hz** key, which can be used in positions **V $\sim$** , **mV $\sim$**  and **A $\sim$** , allows displaying the AC voltage or current frequency measure. The symbol "Hz" is shown on the display. Press the **Hz** key, the **MODE** key or turn the rotary switch to exit the function.

### 4.2.4. RANGE and MODE keys

- Pressing the **RANGE** key allows manually selecting the measuring range of functions **V $\approx$** , **mV $\approx$**  and  $\Omega$ . The symbol "AUTO RANGE" disappears from the display and the cyclic pressure of the key modifies the position of the decimal point on the display. Press and hold the **RANGE** key for more than 1 second or turn the rotary switch to exit the function and restore the symbol "AUTO RANGE" on the display.
- The **MODE** key allows:
  - Selecting the functions on the rotary switch, highlighted in orange
  - Quitting sub-functions selected on the instrument
  - Switching from AutoTest mode to Manual mode (see § 4.3.2).
  - Disabling the Auto Power OFF function (see § 4.3.6).



### 4.3. INTERNAL MODES OF THE INSTRUMENT

#### 4.3.1. MIN/MAX/AVG measurement

In any function, except for the current generation function, it is possible to activate the detection of the Maximum, Minimum and Average (AVG) values of the quantity being tested as follows:

1. Use the 4-arrow selector to select the “MAX”, “MIN” or “AVG” symbols flashing at the bottom of the display.
2. Confirm selection by pressing the **ENTER** key.
3. The values are constantly updated, as soon as the instrument measures a higher (MAX) or lower (MIN) value. The display shows the symbol associated with the selected function: “MAX” for maximum value and “MIN” for minimum value. The symbol “AVG” shows on the display the value of the average between the maximum and the minimum value currently shown on the display.
4. Press the **CANCEL** key or turn the rotary switch to exit the function.

#### 4.3.2. AutoTest and Manual Test mode

In measuring functions “V”, “mV” and “A” it is possible to use the following two modes:

- AutoTest → it allows the automatic detection of AC or DC measurement of voltage or current. The message “AUTOTEST” is shown on the display. This is the mode set whenever the instrument is switched on.
- Manual Test → it allows manually setting the AC or DC measurement of voltage or current.

Press the **MODE** key to switch from AutoTest mode to Manual mode. The message “AUTOTEST” disappears from the display and the modes “DC” or “AC” can be selected by pressing the **MODE** key again. Press and hold the **MODE** key for 2 seconds to go back to the AutoTest mode, or switch off and then on again the instrument.

#### 4.3.3. AC+DC mode

When measuring voltage and current, by pressing the **MODE** key it is possible to select the “AC+DC” measuring mode, which also allows evaluating a possible presence of overlapping direct components on a generic alternating waveform. This can be useful when measuring typical impulsive signals of non-linear loads (e.g. welding machines, electric ovens, etc.).

#### 4.3.4. HFR mode

In measuring functions “V~”, “mV~” and “A~”, by pressing the **HFR** key in Manual mode, it is possible to select “HFR” (High Frequency Reject) measurement. In this case, the AC voltage measurement is carried out considering a maximum signal frequency of 800Hz, and this allows eliminating different harmonic components from it. Press the **HFR** key to exit the “HFR” mode.

#### 4.3.5. STORE and RECALL modes

For each measuring function, except for the current generation function, it is possible to save the displayed value in the instrument's memory and to recall the data saved on the display at any time. The instrument allows saving max. **100** pieces of data in the memory. Proceed as follows:

##### Data saving

1. Select the "STORE" symbol flashing on the display, using the 4-arrow selector located on the front panel of the instrument.
2. Press the **ENTER** key to save the data in the memory. The number of the memory location is immediately shown on the secondary display of the instrument.

##### Recalling on the display and deleting the internal memory

1. Select the "RECALL" symbol flashing on the display, using the 4-arrow selector located on the front panel of the instrument.
2. Press the **ENTER** key. The display shows the value of the measure corresponding to the last memory location used and the number of the location itself.
3. Use the up or down arrow key of the 4-arrow selector located on the front panel of the instrument to select the desired location. Press and hold the arrow keys for more than 1 second in order to carry out a quick search.
4. Press the **CANCEL** key to exit the function.
5. Switch off the instrument, then switch on the instrument again while pressing and holding the **CANCEL** key to delete the internal memory.

#### 4.3.6. Activation/deactivation of the internal functions

The following actions can be activated by pressing and holding the function keys indicated in Table 1 when switching on the instrument:

Key	Action
RANGE	Setting of the modes <b>0-20mA</b> or <b>4-20mA</b> of current generation used by default by the instrument (see § 4.3.7)
MODE	Deactivation of the Auto power off function. The message "APO Off" is provided by the instrument and the indication "APO" disappears from the display. The function is automatically re-activated upon the following instrument start-up.
HFR	Display of the internal Firmware version of the instrument.
ENTER	Activation/deactivation by default of the sound associated with the pressure of the function keys. The messages "Beep On" or "Beep Off" appear on the display.
CANCEL	Clearing of the instrument's internal memory. The message "Clr" is immediately shown on the display.
A-HOLD	Activation of continuous backlighting. The message "Blt On" is immediately shown on the display. The function is automatically disabled upon the following instrument start-up.
REL $\Delta$	Complete deactivation of backlighting. The message "Blt Off" is immediately shown on the display. The function is automatically disabled upon the following instrument start-up.

Table 1: List of internal functions of the instrument

#### 4.3.7. Output DC current generation

The “OUTPUT” section of the function selector switch defines the possibility of generating an output DC current with the instrument, considering the selectable measuring ranges **0-20mA** or **4-20mA**. The instrument may operate in the following modes:

**DC current source** → DC current generation (see § 4.4.7).

**Simulation** → simulation of a transducer in a current loop with auxiliary power supply (see § 4.4.8)

The positions of the rotary switch are the following:

**mA**  → Output DC current, which may be selected as indicated in Table 2

Percentage value (% STEP)	Range 0-20mA	Range 4-20mA
0%	0mA	4mA
25%	5mA	8mA
50%	10mA	12mA
75%	15mA	16mA
100%	20mA	20mA
120%	24mA	Not available
125%	Not available	24mA

Table 2: Selectable values of output DC current

Output current adjustment is possible with the options:

- **%STEP** → setting of values 0%, 25%, 50%, 75%, 100%, 120%, 125% of the selected range.
- **Quick adjustment** → setting of values 0%, 50%, 100% of the selected range.
- **FINE** → setting of custom values in the range  $0 \div 24\text{mA}$  with resolution of  $1\mu\text{A}$ .

**mA**  → Output DC current with automatic ramp as indicated in Table 3





Ramp type	Description	Action
	Slow linear ramp	Passage from 0% → 100% → 0% in 40s
	Quick linear ramp	Passage from 0% → 100% → 0% in 20s
	Slow step ramp	0% → 100% → 0% with ramps of 15s
	Quick step ramp	0% → 100% → 0% with ramps of 5s

Table 3: List of available ramps for output current

#### 4.3.8. Loop Power and HART 250Ω modes

In the **LOOP POWER** function, the instrument is capable of generating an output voltage > 24V DC to supply an external transducer and directly measure the corresponding loop current.

The **HART 250Ω** function allows setting a 250Ω internal resistor for loop measurement on transducers operating with HART™ (Highway Addressable Remote Transducer) protocol.

## 4.4. MEASURING OPERATIONS

### 4.4.1. DC Voltage measurement



#### CAUTION

The maximum input DC voltage is 1000 V. Do not measure voltages exceeding the limits given in this manual. Exceeding voltage limits could result in electrical shocks to the user and damage to the instrument.

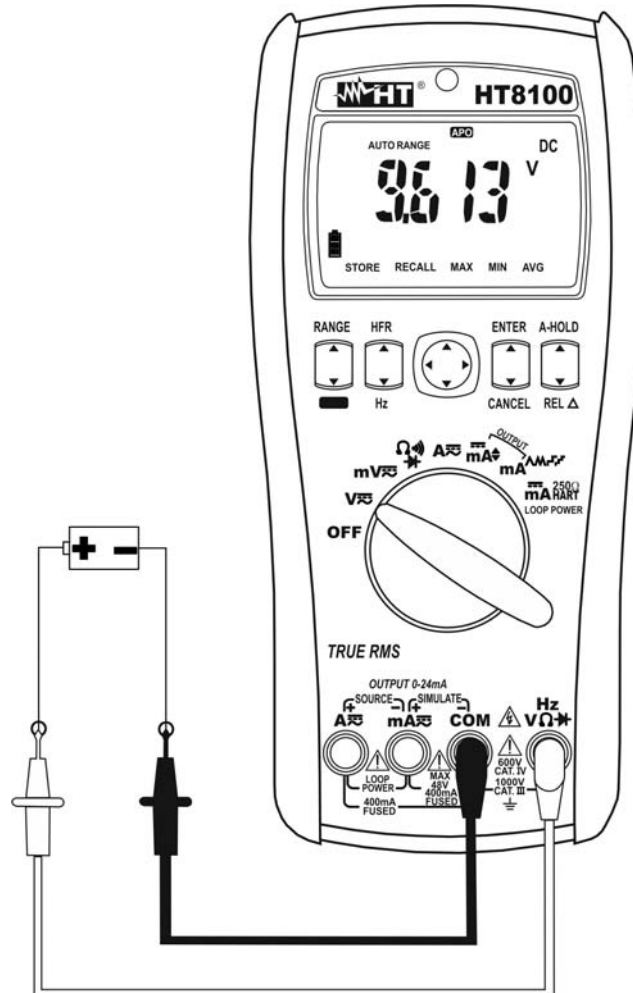

Fig. 2: Use of the instrument for DC voltage measurement

1. Select positions  $V_{\sim}$  or  $mV_{\sim}$
2. Press the **MODE** key for manually selecting “DC” measurement.
3. Use the **RANGE** key for manually selecting the measuring range (see § 4.2.4) or use Autorange selection. If voltage value is unknown, select the highest range.
4. Insert the red cable into input lead **HzVΩ** and the black cable into input lead **COM**
5. Position the red lead and the black lead respectively in the points with positive and negative potential of the circuit to be measured (see Fig. 2). The display shows the value of voltage
6. If the display shows the message “OL”, select a higher range.
7. When symbol “-” appears on the instrument’s display, it means that voltage has the opposite direction with respect to the connection in Fig. 2
8. For using the HOLD function see § 4.2.1, for measuring MAX/MIN/AVG values see § 4.3.1, for relative measurement see § 4.2.1 and for saving the result see § 4.3.5.

#### 4.4.2. AC Voltage and Frequency measurement

### CAUTION



The maximum input AC voltage is 1000Vrms. Do not measure voltages exceeding the limits given in this manual. Exceeding voltage limits could result in electrical shocks to the user and damage to the instrument.

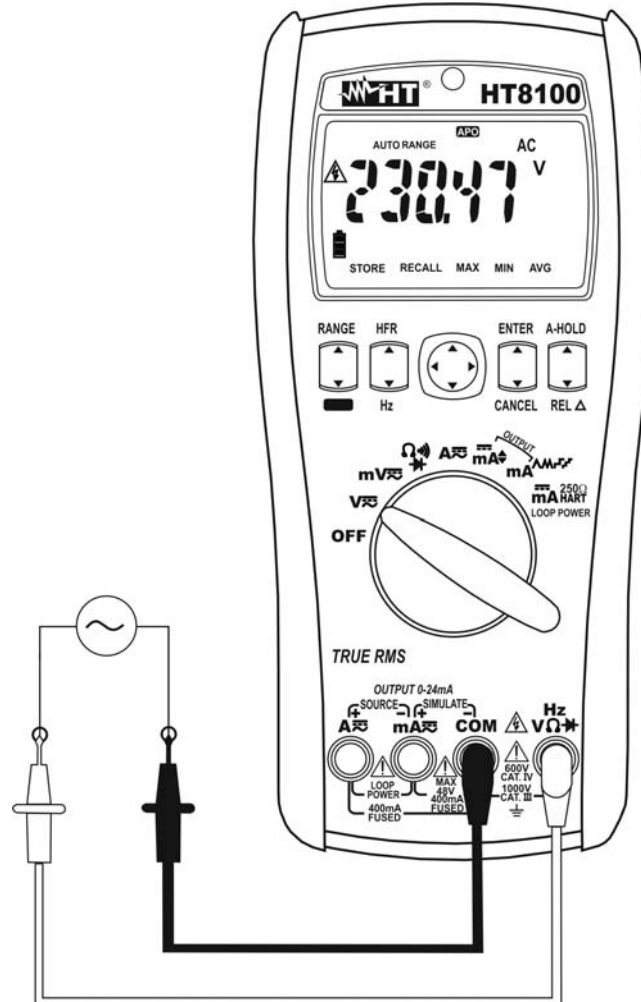

Fig. 3: Use of the instrument for AC voltage measurement

1. Select positions  $V_{\sim}$  or  $mV_{\sim}$
2. Press the **MODE** key for manually selecting “AC” or “AC+DC” measurement (see § 4.3.3) or press the **HFR** key for “HFR” measurement (see § 4.3.4).
3. Use the **RANGE** key for manually selecting the measuring range (see § 4.2.4) or use Autorange selection. If voltage value is unknown, select the highest range.
4. Insert the red cable into input lead **HzVΩ** and the black cable into input lead **COM**
5. Position the red lead and the black lead respectively in the points of the circuit to be measured (see Fig. 3). The display shows the value of voltage.
6. If the display shows the message “OL”, select a higher range.
7. Press the **Hz** key to display the frequency measure of AC voltage. The symbol “Hz” is shown on the display.
8. For using the HOLD function see § 4.2.1, for measuring MAX/MIN/AVG values see § 4.3.1, for relative measurement see § 4.2.1 and for saving the result see § 4.3.5.

#### 4.4.3. DC Current measurement

### CAUTION



The maximum input DC current is 1A. Do not measure currents exceeding the limits given in this manual. Exceeding current limits could result in electrical shocks to the user and damage to the instrument.

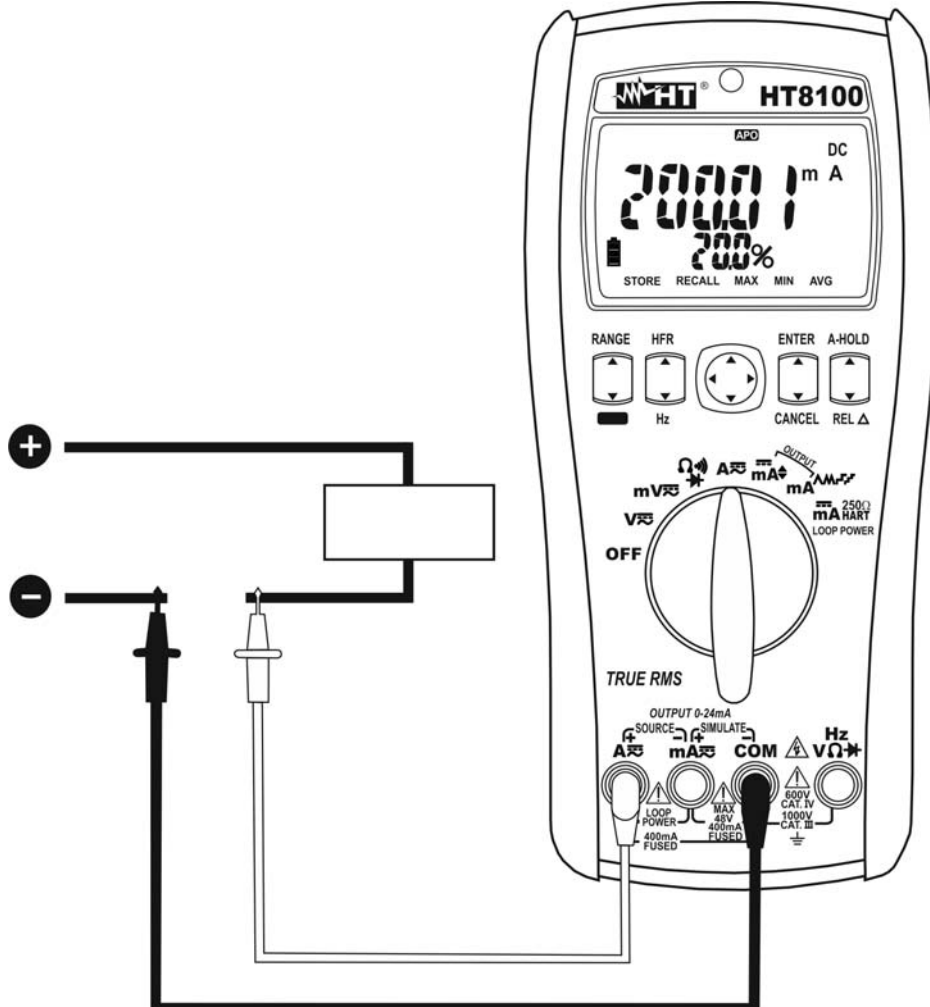

Fig. 4: Use of the instrument for DC current measurement

1. Cut off power supply from the circuit to be measured.
2. Select position **A** or **mA** (for measuring currents <50mA).
3. Press the **MODE** key for manually selecting "DC" measurement.
4. Insert the red cable into input lead **mA** or **A** and the black cable into input lead **COM**.
5. Connect the red lead and the black lead in series to the circuit whose current you want to measure, respecting polarity and current direction (see Fig. 4)
6. Supply the circuit to be measured. The display shows the value of current.
7. If the display shows the message "OL", the maximum measurable value has been reached.
8. When symbol "-" appears on the instrument's display, it means that current has the opposite direction with respect to the connection in Fig. 4
9. For using the HOLD function see § 4.2.1, for measuring MAX/MIN/AVG values see § 4.3.1, for relative measurement see § 4.2.1 and for saving the result see § 4.3.5

#### 4.4.4. AC Current and Frequency measurement

### CAUTION



The maximum input AC current is 1A. Do not measure currents exceeding the limits given in this manual. Exceeding current limits could result in electrical shocks to the user and damage to the instrument.

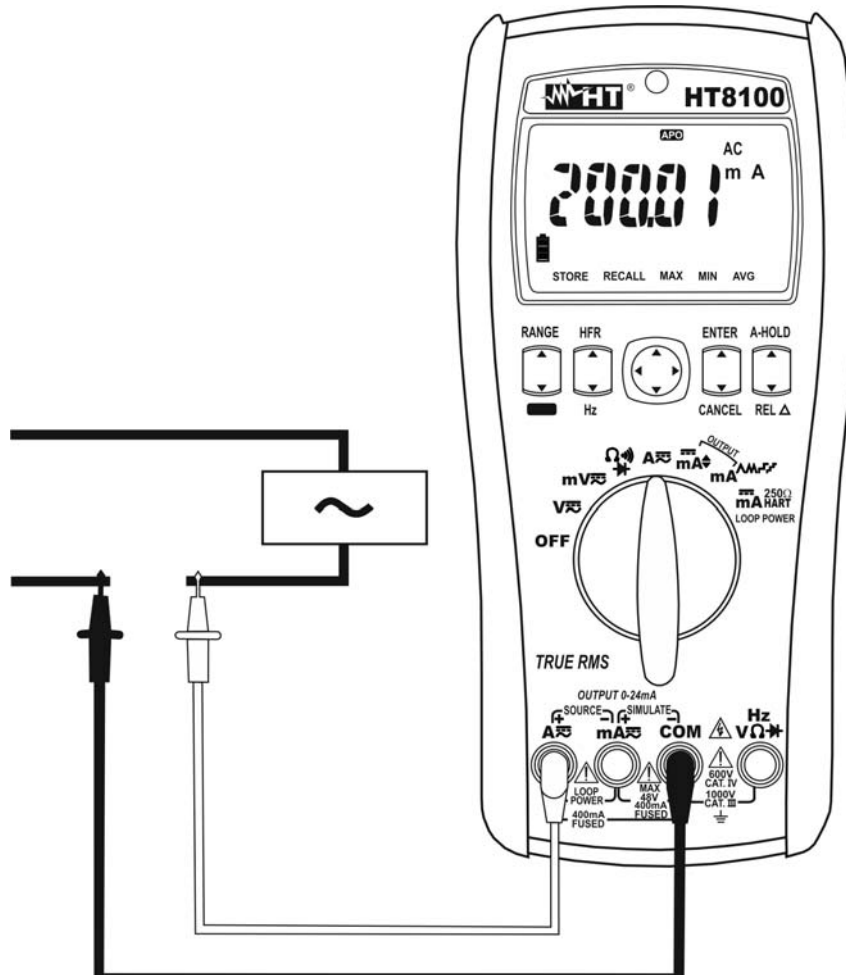

Fig. 5: Use of the instrument for AC current measurement

1. Cut off power supply from the circuit to be measured.
2. Select position **A** or **mA** (for measuring currents <50mA).
3. Press the **MODE** key for manually selecting “AC” or “AC+DC” measurement (see § 4.3.3) or press the **HFR** key for “HFR” measurement (see § 4.3.4).
4. Insert the red cable into input lead **mA** or **A** and the black cable into input lead **COM**
5. Connect the red lead and the black lead in series to the circuit whose current you want to measure (see Fig. 5)
6. Supply the circuit to be measured. The display shows the value of current.
7. If the display shows the message “OL”, the maximum measurable value has been reached.
8. Press the **Hz** key to display the frequency measure of AC current. The symbol “Hz” is shown on the display.
9. For using the HOLD function see § 4.2.1, for measuring MAX/MIN/AVG values see § 4.3.1, for relative measurement see § 4.2.1 and for saving the result see § 4.3.5.

#### 4.4.5. Resistance measurement and Continuity test

### CAUTION



Before attempting any resistance measurement, cut off power supply from the circuit to be measured and make sure that all capacitors are discharged, if present.

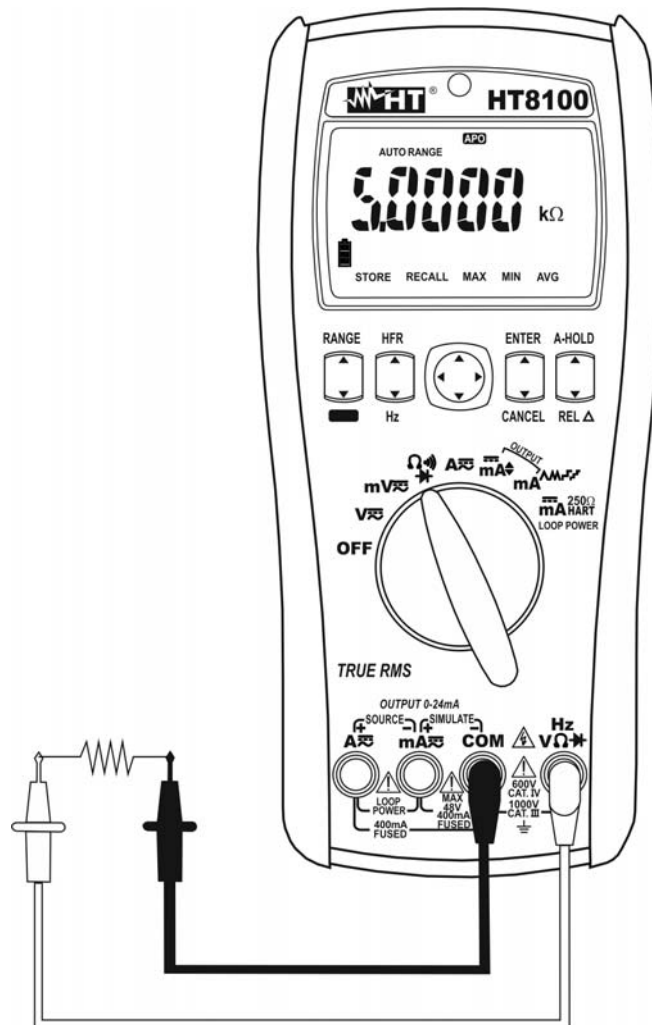

Fig. 6: Use of the instrument for resistance measurement and continuity test

1. Select the  $\Omega$   $\rightarrow$  position. The symbol “M $\Omega$ ” is shown on the display
2. Use the **RANGE** key for manually selecting the measuring range (see § 4.2.4) or use Autorange selection. If the value of resistance is unknown, select the highest range
3. Insert the red cable into input lead **HzV $\Omega$**  and the black cable into input lead **COM**
4. Position the test leads in the desired points of the circuit to be measured (see Fig. 6). The display shows the value of resistance
5. If the display shows the message “OL”, select a higher range.
6. Press the **MODE** key to select the Continuity test. The symbol “ $\rightarrow$ ” is shown on the display. Insert the red and black cables as instructed for resistance measurement. The buzzer activates for resistance values <30 $\Omega$
7. For using the HOLD function see § 4.2.1, for measuring MAX/MIN/AVG values see § 4.3.1 and for saving the result see § 4.3.5



#### 4.4.6. Diode test

### CAUTION



Before attempting any diode test, cut off power supply from the circuit to be measured and make sure that all capacitors are discharged, if present.

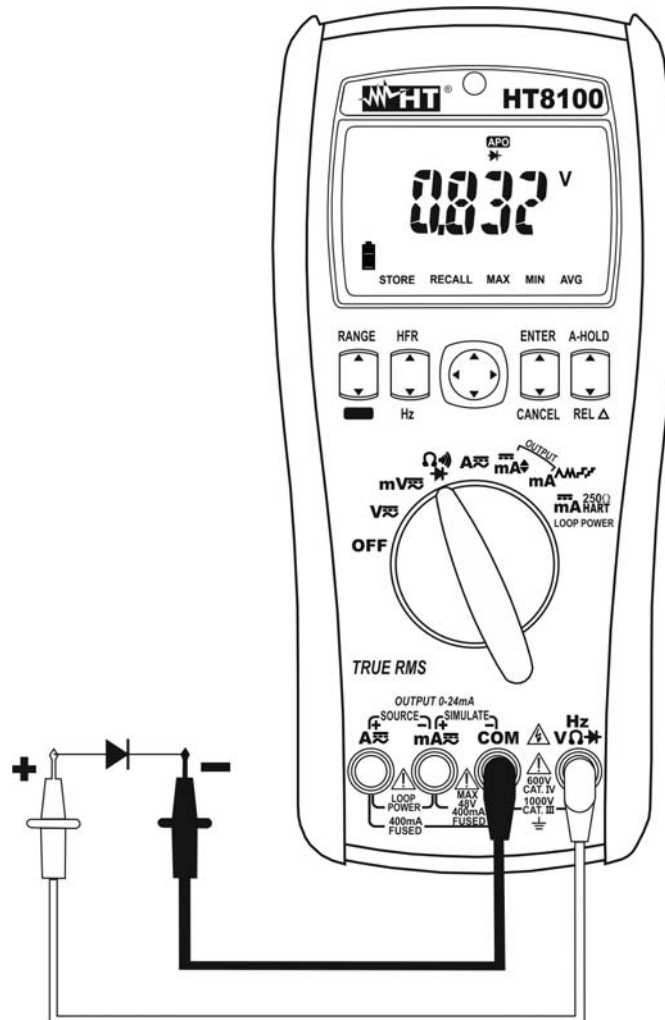

Fig. 7: Use of the instrument for diode test

1. Select the  $\Omega \rightarrow \rightarrow$  position
2. Press the **MODE** key to select the Diode Test. The symbol “ $\rightarrow$ ” is shown on the display
3. Insert the red cable into input lead **HzVΩ** and the black cable into input lead **COM**.
4. Position the leads at the ends of the diode to be tested, respecting the indicated polarity (see Fig. 7). The value of directly polarized threshold voltage is shown on the display. For a good P-N junction, the instrument must show a value between 0.4 and 0.9V. If threshold value is equal to 0mV, the P-N junction of the diode is short-circuited.
5. If the instrument shows the message “**OL**”, the terminals of the diode are reversed with respect to the indication given in Fig. 7 otherwise, the P-N junction of the diode is damaged
6. For using the HOLD function see § 4.2.1, for measuring MAX/MIN/AVG values see § 4.3.1 and for saving the result see § 4.3.5

#### 4.4.7. DC current generation

### CAUTION



The maximum output DC current generated by the instrument is 24mA with internal battery voltage > 4.5VDC.

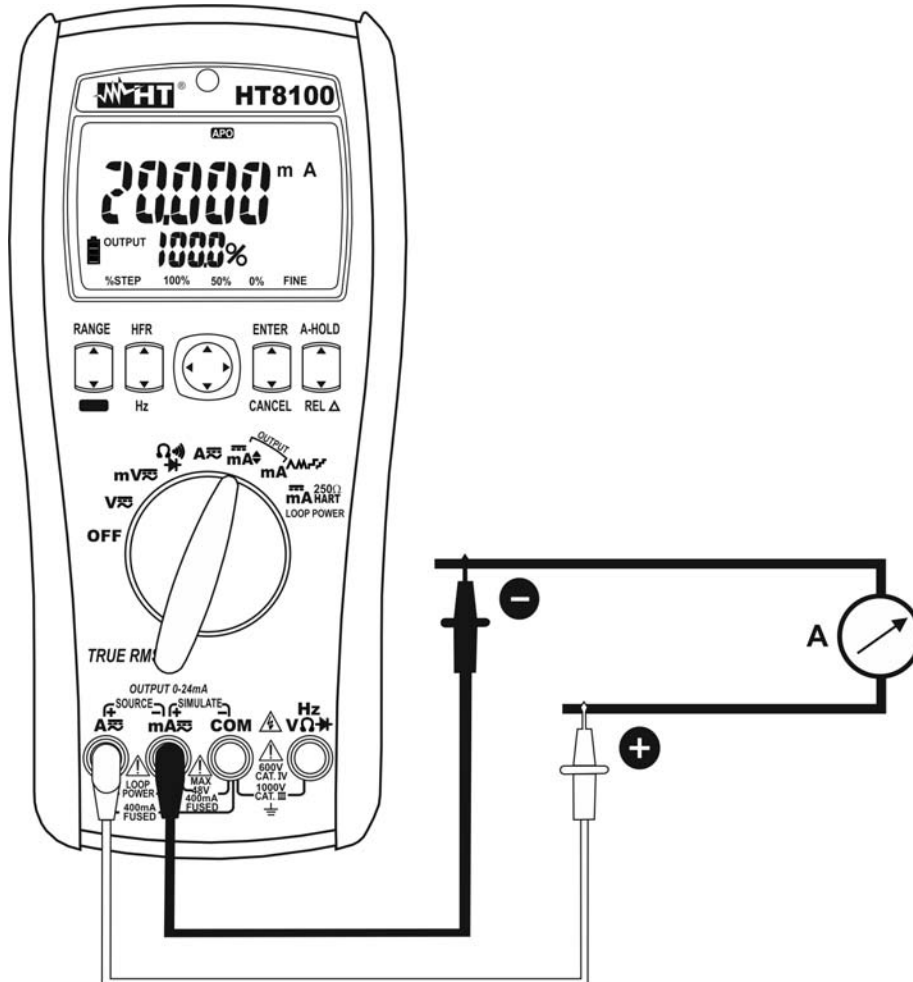

Fig. 8: Use of the instrument for DC current generation

1. Switch on the instrument by pressing and holding the **RANGE** key to select the measuring range **0-20mA** or **4-20mA**.
2. Select the position **mA** with an upward arrow in case of programmable DC current generation or position **mA** with a ramp symbol for DC current generation with automatic ramp.
3. Use the 4-arrow selector on the front panel to select the options “%STEP”, “100%”, “50%”, “0%” or “END” flashing on the display and confirm with the **ENTER** key in case of selectable current generation, or press the **MODE** key to select the ramp type (see § 4.3.7)
4. Insert the red cable into input lead **mA** and the black cable into input lead **COM**. The instrument automatically generates the output current considering the selected options. Press the **A-HOLD** key to suspend/restore the generation
5. Position the red lead and the black lead respectively in the points with positive and negative potential of the passive external device which must be supplied (see Fig. 8)
6. Turn the rotary switch to exit the function and stop generation. Remove the cable from lead **mA** before turning the rotary switch.

#### 4.4.8. Simulation of a transducer

### CAUTION



In this mode, the instrument provides an adjustable output current up to 24mA DC. It is necessary to provide an external power supply with voltage between 6V and 48VDC in order to adjust current.

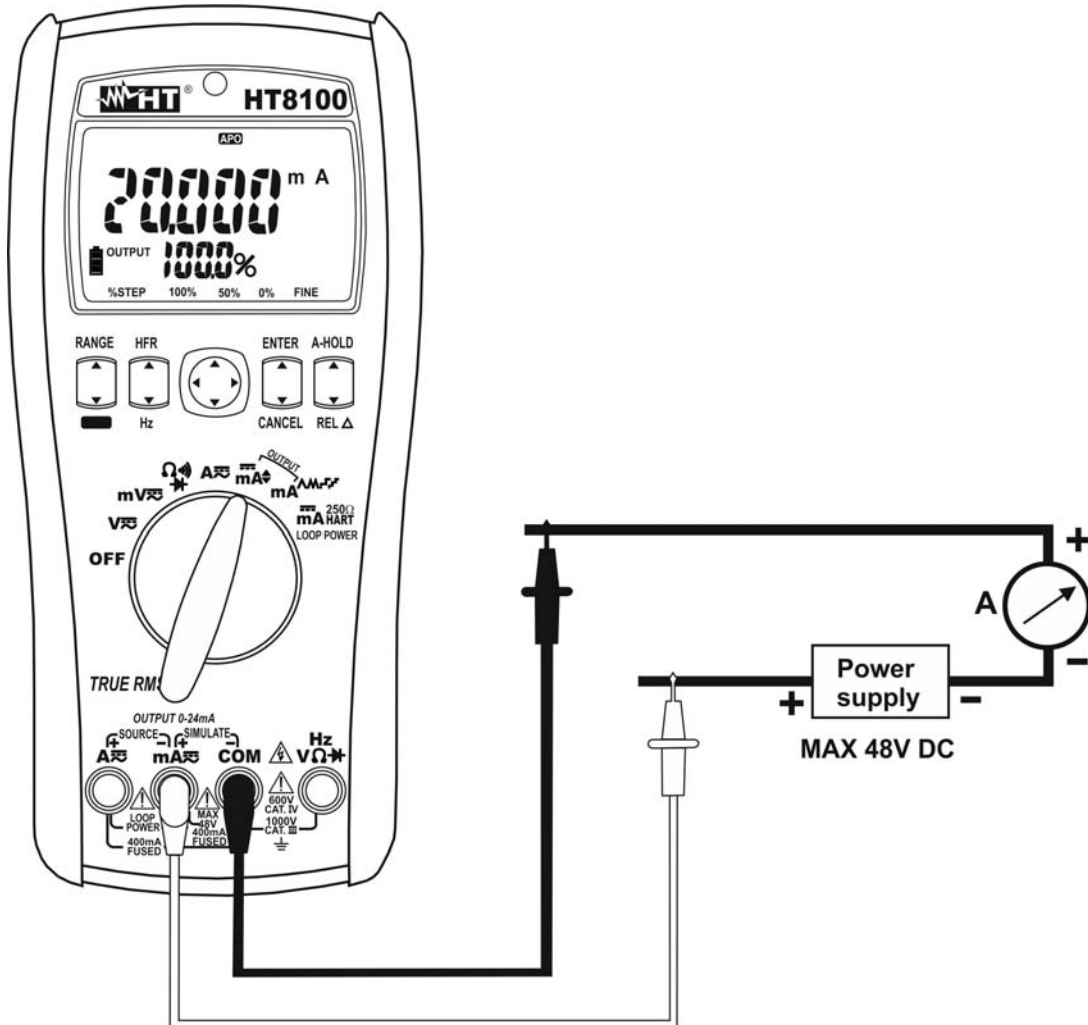

Fig. 9: Use of the instrument for simulating a transducer

1. Switch on the instrument by pressing and holding the **RANGE** key to select the measuring range **0-20mA** or **4-20mA**.
2. Select the position **mA** in case of programmable DC current generation or position **mAA** for DC current generation with automatic ramp.
3. Use the 4-arrow selector on the front panel to select the options “%STEP”, “100%”, “50%”, “0%” or “END” flashing on the display and confirm with the **ENTER** key in case of selectable current generation, or press the **MODE** key to select the ramp type (see § 4.3.7)
4. Insert the red cable into input lead **mA** and the black cable into input lead **COM**. The instrument automatically generates the output current considering the selected options. Press the **A-HOLD** key to suspend/restore the generation
5. Position the red lead and the black lead respectively in the points with positive potential of the external source and positive potential of the external measuring device (e.g.: multimeter – see Fig. 9)
6. Turn the rotary switch to exit the function and stop generation. Remove the cable from lead **mA** before turning the rotary switch.

#### 4.4.9. Measuring output DC current from external transducers (Loop)



### CAUTION

In this mode, the instrument provides an output voltage  $> 24\text{VDC}$  /  $20\text{mA}$ , capable of supplying an external transducer and allowing measuring loop current at the same time.

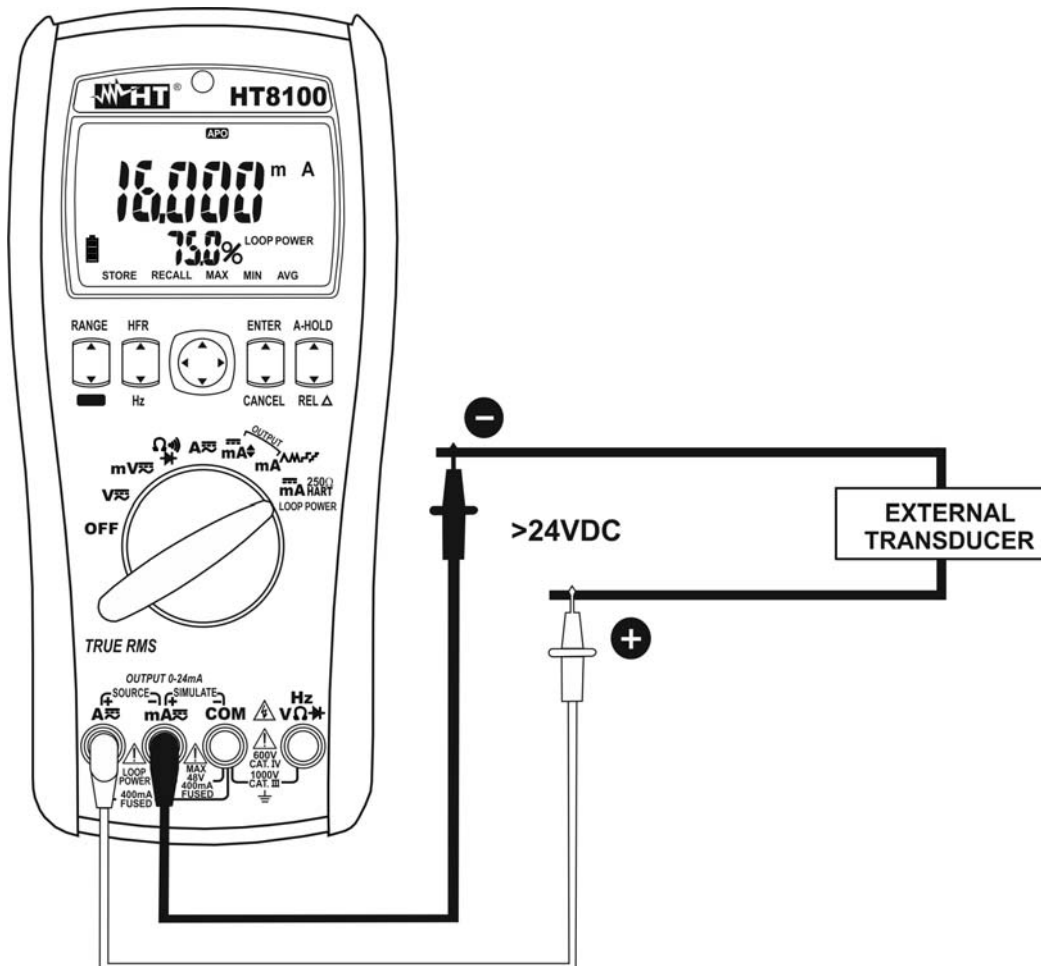

Fig. 10: Use of the instrument for measuring output DC current from external transducers

1. Cut off power supply from the circuit to be measured.
2. Select the position **mA LOOP POWER**. The message "LOOP POWER" is shown on the display. If necessary, press the **MODE** key for selecting the **250Ω HART** mode (see § 4.3.8). The message "250Ω HART" is shown on the display.
3. Insert the red cable into input lead **mA** and the black cable into input lead **COM**.
4. Connect the red lead and the black lead to the external transducer, respecting current polarity and direction (see Fig. 10)
5. Supply the circuit to be measured. The display shows the value of current.
6. The message "OL" indicates that the current being measured exceeds the maximum value measurable by the instrument.
7. For using the HOLD function see § 4.2.1, for measuring MAX/MIN/AVG values see § 4.3.1, for relative measurement see § 4.2.1 and for saving the result see § 4.3.5.
8. Turn the rotary switch to exit the function. Remove the cable from lead **mA** before turning the rotary switch.

## 5. MAINTENANCE



### CAUTION

- Only expert and trained technicians should perform maintenance operations. Before carrying out maintenance operations, disconnect all cables from the input terminals.
- Do not use the instrument in environments with high humidity levels or high temperatures. Do not expose to direct sunlight.
- Always switch off the instrument after use. In case the instrument is not to be used for a long time, remove the battery to avoid liquid leaks that could damage the instrument's internal circuits.

### 5.1. REPLACING THE BATTERIES AND THE INTERNAL FUSES

When the LCD displays the “” symbol, replace the batteries.

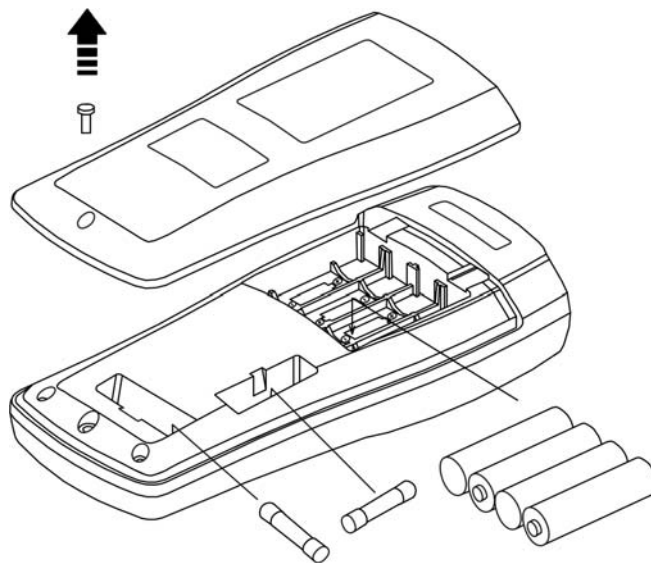

Fig. 11: Replacing the batteries and the internal fuses

#### Battery replacement

1. Remove the test leads.
2. Remove the fastening screw and remove the battery compartment cover.
3. Remove the batteries and insert the same number of batteries of the same type (see § 6.1.3) respecting the correct polarity, then restore the battery compartment cover (see Fig. 11). Use the relevant containers for battery disposal.

#### Fuse replacement

1. Position the rotary switch to OFF and remove the cables from the input terminals
2. Remove the fastening screw and remove the battery compartment cover.
3. Remove the damaged fuses, insert the same number of fuses of the same type (see § 6.1.3) and close the battery compartment again.

### 5.2. CLEANING THE INSTRUMENT

Use a soft and dry cloth to clean the instrument. Never use wet cloths, solvents, water, etc.

### 5.3. END OF LIFE



**WARNING:** the symbol on the instrument indicates that the appliance and its accessories must be collected separately and correctly disposed of.

## 6. TECHNICAL SPECIFICATIONS

### 6.1. TECHNICAL CHARACTERISTICS

Accuracy indicated as [% reading + (number of dgt \* resolution)] at 23°C±5°C, <80%RH

#### DC Voltage

Range	Resolution	Accuracy	Input impedance	Protection against overcharge
50.000mV	0.001mV	±(0.05%rdg+5dgt)	10MΩ // <100pF	1000VDC/ACrms
500.00mV	0.01mV			
5.0000V	0.0001V			
50.000V	0.001V			
500.00V	0.01V			
1000.0V	0.1V			

#### AC TRMS Voltage

Range	Resolution	Accuracy (**) (Sinusoidal signal)	Input impedance	Protection against overcharge
50.000mV	0.001mV	±(0.7%rdg+20dgt) (40Hz ÷ 70Hz)	10MΩ // <100pF	1000VDC/ACrms
500.00mV	0.01mV			
5.0000V	0.0001V	±(0.5%rdg+20dgt) (40Hz ÷ 70Hz)		
50.000V	0.001V			
500.00V	0.01V	±(1.5%rdg+40dgt) (71Hz ÷ 1kHz)		
1000.0V (*)	0.1V			
		±(3.0%rdg+80dgt) (1.001kHz ÷ 10kHz)		

Frequency range: 40Hz ÷ 10kHz ;

(\*\*) For values <5% of each range add 20dgt to the accuracy

(\*) Frequency range of this range: 40Hz ÷ 1kHz

For non-sinusoidal voltages, consider the following crest factors (CF):

1.4 ≤ FC < 2.0 → Add 1.0% reading to accuracy

2.0 ≤ FC < 2.5 → Add 2.5% reading to accuracy

2.5 ≤ FC ≤ 3.0 → Add 4.0% reading to accuracy

Accuracy in AC+DC mode: AC accuracy + DC accuracy + 1.0%reading

Accuracy in HFR mode: AC accuracy + 1.0%reading (40Hz ÷ 400Hz)

Cutting frequency in HFR mode: 800Hz (-3dB) ; Characteristic attenuation: approx. -24dB

#### DC Current measurement

Range	Resolution	Accuracy	Max measuring time	Protection against overcharge
50.000mA	0.001mA	±(0.05%rdg + 5dgt)	1min (input A) 10min (input mA)	max 440mA
1.000A	0.001A			

#### AC TRMS Current measurement

Range	Resolution	Accuracy (*) (Sinusoidal signal)	Max measuring time	Protection against overcharge
50.000mA	0.001mA	±(1.0%rdg + 20dgt) (40Hz ÷ 70Hz)	1min (input A) 10min (input mA)	max 440mA
1.000A	0.001A			
		±(2.0%rdg + 40dgt) (71Hz ÷ 10kHz)		

(\*) For values <5% of each range add 20dgt to the accuracy ; Frequency range: 40Hz ÷ 10kHz

Input impedance: 0.1Ω (input A), 13Ω (input mA)

For non-sinusoidal currents, consider the same conditions of TRMS AC Voltage

**Resistance**

Range	Resolution	Accuracy	Output current	Protection against overcharge
500.00Ω	0.01Ω	±(0.2%rdg+30dgt)	1mA	1000VDC/ACrms
5.0000kΩ	0.0001kΩ	±(0.2%rdg+10dgt)	100μA	
50.000kΩ	0.001kΩ		10μA	
500.00kΩ	0.01kΩ	±(0.5%rdg+10dgt)	1μA	
5.0000MΩ	0.0001MΩ	±(1.0%rdg+10dgt)	100nA	
50.00MΩ (*)	0.01MΩ	±(2.0%rdg+10dgt)	10nA	

(\*) Slight instability &lt; 20 dgt

Maximum open-circuit voltage: approx 3.5V

**Continuity test**

Range	Accuracy	Buzzer	Open-circuit voltage	Protection against overcharge
500.00Ω	±(0.1%rdg+30dgt)	<30Ω	circa 3.5V	1000VDC/ACrms

**Diode test**

Range	Accuracy	Test current	Open-circuit voltage	Protection against overcharge
2.000V	±(1.0%rdg+10dgt)	±1mA	circa ±3V	1000VDC/ACrms

**AC Voltage and AC Current Frequency**

Range	Resolution	Accuracy	Protection against overcharge
500.00Hz	0.01Hz	±3dgt	1000VDC/ACrms max 440mA
5.0000kHz	0.0001kHz		
50.000kHz	0.001kHz		
100.00kHz	0.01kHz		

Minimum frequency value: 5Hz

**Sensitivity for frequency measurements**

Function	Range	Sensitivity (peak to peak value)	
		5Hz ÷ 10kHz	10kHz ÷ 100kHz
AC mV	50.000mV	10mV	100mV
	500.00mV		
AC V	5.0000V	1V	Unspecified
	50.000V	1V	
	500.00V		
	1000.0V		
AC A	50.000mA	10mA	
	1.000A	300mA	





**Generated DC Current – Programmable output**

Range	Resolution	Accuracy	Protection against overcharge
0.000÷20.000mA	0.001mA	±(0.05%rdg+5dgt)	max 440mA
4.000÷20.000mA			

Power supply: battery level &gt; 4.5V. External power supply in simulation mode: 6V ÷ 48V

Source mode: 1.200Ω @20mA (battery voltage &gt;4.5V)

### Generated DC current – Output ramp

Ramp type	Description	Action
	Slow linear ramp	Passage from 0% →100% →0% in 40s
	Quick linear ramp	Passage from 0% →100% →0% in 20s
	Slow step ramp	0% →100% →0% with ramps of 15s
	Quick step ramp	0% →100% →0% with ramps of 5s

Output voltage: 32.0VDC: Output voltage accuracy:  $\pm 5.0\%$  of reading  
 Power supply: battery level > 4.5V  
 External power supply in simulation mode: 6V  $\div$  48V

### Loop Power (Loop current)

Function	Range	Accuracy	Driver	Protection against overcharge
LOOP	50.000mA	$\pm(0.05\%rdg+5dgt)$	30V / 1.25k $\Omega$	max 440mA
250 $\Omega$ HART			24V / 1k $\Omega$	

Output voltage: 32.0VDC: Output voltage accuracy:  $\pm 5.0\%$  of reading  
 Power supply: battery level > 4.5V  
 Minimum output voltage: 24V

#### 6.1.1. Electrical characteristics

Conversion: TRMS  
 Sampling frequency: 10 times per second  
 Temperature coefficient:  $0.1 \times (\text{accuracy}) / ^\circ\text{C}$ , <18 $^\circ\text{C}$  or >28 $^\circ\text{C}$   
 NMRR Normal Mode Rejection Ratio: > 50dB for DC quantities and 50/60Hz  
 CMRR Common Mode Rejection Ratio: >100dB from DC and 50/60Hz (DCV)  
 > 60dB from DC and 50/60Hz (ACV)

#### 6.1.2. Considered standards

Safety: IEC/EN61010-1, EN61010-2-030  
 Insulation: double insulation  
 Pollution level: 2  
 Overvoltage category: CAT IV 600V, CAT III 1000V  
 Max operating altitude: 2000m (6561ft)

#### 6.1.3. General characteristics

##### Mechanical characteristics

Size (with shell): 207 (L) x 95 (W) x 52 (H) mm (8 x 4 x 2 inch)  
 Weight (batteries included): 630g (22 ounces)

##### Power supply

Battery type: 4 x 1.5V alkaline type AA IEC LR6  
 Low battery indication: symbol  with battery voltage < approx. 4.5V  
 Battery life: approx. 100 hours  
 Automatic power off: after 20 minutes (may be disabled)  
 Fuses: 2x F440mA/1000V, 10kA Bussmann type

##### Memory

Characteristics: max 100 locations

##### Display

Characteristics: LCD 5 dgt, 50000 dots, decimal sign and point, autobacklight  
 Over range indication: "OL" or "-OL"



## 6.2. ENVIRONMENT

### 6.2.1. Environmental conditions for use

Reference temperature:	23° ± 5°C (73 ± 41°F)
Operating temperature/humidity:	-10°C ÷ 30°C (14°F ÷ 86°F), <85%RH
	30°C ÷ 40°C (86°F ÷ 104°F), <75%RH
	40°C ÷ 50°C (104°F ÷ 122°F), <45%RH
Storage temperature:	-20° ÷ 60°C (-4 ÷ 140°F) (batteries not inserted)
Storage humidity:	<80%RH

**This instrument satisfies the requirements of Low Voltage Directive 2006/95/EC  
(LVD) and of EMC Directive 2004/108/EC**

## 6.3. ACCESSORIES

### 6.3.1. Accessories provided

- Pair of test leads
- Pair of alligator clips
- Belt with magnetic end for fastening to metal surfaces
- Protection shell
- Batteries (not inserted)
- User manual

## 7. SERVICE

### 7.1. WARRANTY CONDITIONS

This instrument is warranted against any material or manufacturing defect, in compliance with the general sales conditions. During the warranty period, defective parts may be replaced. However, the manufacturer reserves the right to repair or replace the product.

Should the instrument be returned to the After-sales Service or to a Dealer, transport will be at the Customer's charge. However, shipment will be agreed in advance.

A report will always be enclosed to a shipment, stating the reasons for the product's return. Only use original packaging for shipment; any damage due to the use of non-original packaging material will be charged to the Customer.

The manufacturer declines any responsibility for injury to people or damage to property.

The warranty shall not apply in the following cases:

- Repair and/or replacement of accessories and battery (not covered by warranty).
- Repairs that may become necessary as a consequence of an incorrect use of the instrument or due to its use together with non-compatible appliances.
- Repairs that may become necessary as a consequence of improper packaging.
- Repairs which may become necessary as a consequence of interventions performed by unauthorized personnel.
- Modifications to the instrument performed without the manufacturer's explicit authorization.
- Use not provided for in the instrument's specifications or in the instruction manual.

The content of this manual cannot be reproduced in any form without the manufacturer's authorization.

**Our products are patented and our trademarks are registered. The manufacturer reserves the right to make changes in the specifications and prices if this is due to improvements in technology.**

### 7.2. SERVICE

If the instrument does not operate properly, before contacting the After-sales Service, please check the conditions of batteries and cables and replace them, if necessary.

Should the instrument still operate improperly, check that the product is operated according to the instructions given in this manual.

Should the instrument be returned to the After-sales Service or to a Dealer, transport will be at the Customer's charge. However, shipment will be agreed in advance.

A report will always be enclosed to a shipment, stating the reasons for the product's return. Only use original packaging for shipment; any damage due to the use of non-original packaging material will be charged to the Customer.