

If the outboard motor's serial number plate contains the CE mark in the lower left-hand corner, the following statement applies:

This outboard motor manufactured by Mercury Marine, Fond du Lac, WI, USA or Marine Power Europe Inc. Park Industriel, de Petit-Rechain, Belgium complies with the requirements of the following directives and standards, as amended:

Recreational Craft Directive: 94/25/EC; std. ISO 8665, ISO 11547

Machinery Directive: 98/37/EC,

EMC Directive: 89/336/EC; std. EN50081-1, SAE J551 (CISPR Pub. 12), EN 50082-1, IEC 61000 PT4-2, IEC 61000 PT4-3



Patrick C. Mackey

President, Mercury Marine, Fond du Lac, WI USA

European Regulations Contact:

Product Environmental Engineering Department, Mercury Marine,
Fond du Lac, WI USA

EPA Emissions Regulations

Outboards manufactured by Mercury Marine in the United States are certified to the United States Environmental Protection Agency as conforming to the requirements of the regulations for the control of air pollution from new outboard motors. This certification is contingent on certain adjustments being set to factory standards. For this reason, the factory procedure for servicing the product must be strictly followed and, wherever practicable, returned to the original intent of the design. **Maintenance, replacement, or repair of the emission control devices and systems may be performed by any marine engine repair establishment or individual.**

Engines are labeled with an Emission Control Information decal as permanent evidence of EPA certification.

WARNING

The engine exhaust from this product contains chemicals known to the state of California to cause cancer, birth defects or other reproductive harm.

Thank You

for your purchase of one of the finest outboards available. You have made a sound investment in boating pleasure. Your outboard has been manufactured by Mercury Marine, a world leader in marine technology and outboard manufacturing since 1939. These years of experience have been committed to the goal of producing the finest quality products. This led to Mercury Marine's reputation for strict quality control, excellence, durability, lasting performance and being the best at providing after the sale support.

Please read this manual carefully before operating your outboard. This manual has been prepared to assist you in the operation, safe use and care of your outboard.

All of us at Mercury Marine took pride in building your outboard and wish you many years of happy and safe boating.

Again, thank you for your confidence in Mercury Marine.

Warranty Message

The product you have purchased comes with a **limited warranty** from Mercury Marine, the terms of the warranty are set forth in the **Warranty Information** Section of this manual. The warranty statement contains a description of what is covered, what is not covered, the duration of coverage, how to best obtain warranty coverage, **important disclaimers and limitations of damages**, and other related information. Please review this important information.

The description and specifications contained herein were in effect at the time this manual was approved for printing. Mercury Marine, whose policy is one of continued improvement, reserves the right to discontinue models at any time, to change specifications, designs, methods, or procedures without notice and without incurring obligation.

Mercury Marine, Fond du Lac, Wisconsin U.S.A.

Litho in U.S.A.

© 2004, Mercury Marine

Mercury, Mercury Marine, MerCruiser, Mercury MerCruiser, Mercury Racing, Mercury Precision Parts, Mercury Propellers, Mariner, Quicksilver, #1 On The Water, Alpha, Bravo, Pro Max, OptiMax, Sport-Jet, K-Planes, MerCathode, RideGuide, SmartCraft, Zero Effort, M with Waves logo, Mercury with Waves logo, and SmartCraft logo are all registered trademarks of Brunswick Corporation. Mercury Product Protection logo is a registered service mark of Brunswick Corporation.

Mercury Premier Service

Mercury evaluates the service performance of its dealers and assigns its highest rating of "Mercury Premier" to those demonstrating an exceptional commitment to service.

Earning a Mercury Premier Service rating means a dealer:

- Achieves a 12 month service CSI (Customer Satisfaction Index) score above the national average.
- Possesses all necessary service tools, test equipment, manuals and parts books.
- Employs at least one Certified or Master technician.
- Provides timely service for all Mercury Marine customers.
- Offers extended service hours and mobile service, when appropriate.
- Uses, displays and stocks adequate inventory of genuine Mercury Precision Parts.
- Offers a clean, neat shop with well organized tools and service literature.

TABLE OF CONTENTS

WARRANTY INFORMATION

Transfer Of Warranty.....	1
Warranty Registration United States And Canada.....	1
Warranty Registration Outside The United States And Canada.....	2
Four Stroke Outboard Limited Warranty.....	3
3 Year Limited Warranty Against Corrosion.....	6
Warranty Coverage And Exclusions.....	9
California Emissions Limited Warranty.....	11
Star Label.....	16

GENERAL INFORMATION

Boater's Responsibilities.....	18
Before Operating Your Outboard.....	18
Boat Horsepower Capacity.....	18
High-Speed And High-Performance Boat Operation.....	19
Outboard Remote Control Models	19
Remote Steering Notice.....	20
Lanyard Stop Switch.....	21
Protecting People In The Water.....	23
Passenger Safety Message - Pontoon Boats And Deck Boats.....	24
Wave And Wake Jumping.....	25
Impact With Underwater Hazards.....	26
Safety Instructions For Hand Tilled Outboards.....	27
Exhaust Emissions.....	27
Selecting Accessories For Your Outboard.....	29
Safe Boating Suggestions.....	29
Recording Serial Number.....	31
40/50/60 4-Stroke Specifications.....	31
Component Identification.....	33

INSTALLATION

Installing Outboard.....	34
Propeller Selection.....	35

TRANSPORTING

Trailerling Boat/Outboard	36
---------------------------------	----

TABLE OF CONTENTS

Transporting Portable Fuel Tanks.....	36
---------------------------------------	----

FUEL & OIL

Gasoline Recommendations.....	38
Filling Fuel Tank.....	39
Engine Oil Recommendations.....	40
Checking And Adding Engine Oil.....	40

FEATURES & CONTROLS

Remote Control Features.....	42
Warning System.....	43
Power Trim and Tilt (If Equipped).....	46
Throttle Grip Friction Adjustment - Tiller Handle Models.....	51
Steering Friction Adjustment.....	51
Trim Tab Adjustment.....	52

OPERATION

Pre-Starting Check List.....	54
Operating In Freezing Temperatures.....	54
Operating In Salt Water Or Polluted Water.....	54
Pre-Starting Instructions.....	55
Engine Break-in Procedure.....	56
Starting The Engine - Remote Control Models.....	56
Starting The Engine - Tiller Handle Models.....	59
Gear Shifting	61
Stopping The Engine	62
Emergency Starting	62

MAINTENANCE

Outboard Care.....	65
EPA Emissions Regulations.....	65
Inspection And Maintenance Schedule.....	66
Flushing The Cooling System.....	68
Top Cowl Removal And Installation.....	69
Exterior Care.....	69
Battery Inspection	69

TABLE OF CONTENTS

Fuel System.....	70
Steering Link Rod Fasteners.....	71
Corrosion Control Anode.....	73
Propeller Replacement - 87.3 mm(3 - 7/16 in.) Diameter Gearcase.....	73
Propeller Replacement - 108 mm (4 - 1/4 in.) Diameter Gearcase.....	76
Spark Plug Inspection And Replacement.....	79
Fuse Replacement.....	80
Timing Belt Inspection.....	81
Lubrication Points.....	82
Checking Power Trim Fluid.....	84
Changing Engine Oil	84
Gearcase Lubrication - For 87.3 mm(3-7/16 in.) Diameter Gearcase... ..	86
Gearcase Lubrication - For 108 mm(4 - 1/4 in.) Diameter Gearcase... ..	88
Submerged Outboard.....	89

STORAGE

Storage Preparation.....	90
Protecting External Outboard Components.....	91
Protecting Internal Engine Components.....	91
Gearcase.....	91
Positioning Outboard For Storage.....	91
Battery Storage.....	91

TROUBLESHOOTING

Starter Motor Will Not Crank The Engine (Electric Start Models).....	92
Engine Will Not Start.....	92
Engine Runs Erratically.....	92
Performance Loss.....	93
Battery Will Not Hold Charge.....	93

OWNER SERVICE ASSISTANCE

Local Repair Service.....	94
Service Away From Home.....	94
Parts And Accessories Inquiries.....	94
Service Assistance.....	94
Mercury Marine Service Offices.....	95

TABLE OF CONTENTS

MAINTENANCE LOG

Maintenance Log.....	97
----------------------	----

WARRANTY INFORMATION

Transfer Of Warranty

The limited warranty is transferable to a subsequent purchaser, but only for the remainder of the unused portion of the limited warranty. This will not apply to products used for commercial applications.

To transfer the warranty to the subsequent owner, send or fax a copy of the bill of sale or purchase agreement, new owner's name, address and engine serial number to Mercury Marine's warranty registration department.

Mercury Marine
Attn: Warranty Registration Department
W6250 W. Pioneer Road
P.O. Box 1939
Fond du Lac, WI 54936-1939
920-929-5054

Upon processing the transfer of warranty, Mercury Marine will send registration verification to the new owner of the product by mail.

There is no charge for this service.

For products purchased outside the United States and Canada, contact the distributor in your country, or the Mercury Marine Service Office closest to you.

Warranty Registration United States And Canada

1. You may change your address at any time, including at time of warranty claim, by calling Mercury Marine or sending a letter or fax with your name, old address, new address, and engine serial number to Mercury Marine's warranty registration department. Your dealer can also process this change of information.

Mercury Marine
Attn: Warranty Registration Department
W6250 Pioneer Road
P.O. Box 1939
Fond du Lac, WI 54935-1939
920-929-5054

NOTE: *Registration lists must be maintained by Mercury Marine and any dealer on marine products sold in the United States, should a safety recall notification under the Federal Safety Act be required.*

WARRANTY INFORMATION

2. To be eligible for warranty coverage, the product must be registered with Mercury Marine. At the time of sale, the dealer should complete the warranty registration and immediately submit it to Mercury Marine via MercNET, E-mail, or mail. Upon receipt of this warranty registration, Mercury Marine will record the registration.
3. Upon processing the warranty registration, Mercury Marine will send registration verification by mail to the purchaser of the product. If this registration verification is not received within 30 days, please contact your selling dealer immediately. Warranty coverage is not effective until your product is registered with Mercury Marine.

Warranty Registration Outside The United States And Canada

1. It is important that your selling dealer fills out the Warranty Registration Card completely and mails it to the distributor or Marine Power Service Center responsible for administering the warranty registration/claim program for your area.
2. The Warranty Registration Card identifies your name and address, product model and serial numbers, date of sale, type of use and the selling distributor's/dealer's code number, name and address. The distributor/dealer also certifies that you are the original purchaser and user of the product.
3. A copy of the Warranty Registration Card, designated as the Purchaser's Copy, MUST be given to you immediately after the card has been completely filled out by the selling distributor/dealer. This card represents your factory registration identification, and should be retained by you for future use when required. Should you ever require warranty service on this product, your dealer may ask you for the Warranty Registration Card to verify date of purchase and to use the information on the card to prepare the warranty claim forms.
4. In some countries, the Marine Power Service Center will issue you a permanent (plastic) Warranty Registration Card within 30 days after receiving the Factory Copy of the Warranty Registration Card from your distributor/dealer. If you receive a plastic Warranty Registration Card, you may discard the Purchaser's Copy that you received from the distributor/dealer when you purchased the product. Ask your distributor/dealer if this plastic card program applies to you.

WARRANTY INFORMATION

IMPORTANT: Registration lists must be maintained by the factory and dealer in some countries by law. It is our desire to have ALL products registered at the factory should it ever be necessary to contact you. Make sure your dealer/distributor fills out the warranty registration card immediately and sends the factory copy to the Marine Power International Service Center for your area.

5. For further information concerning the Warranty Registration Card and its relationship to Warranty Claim processing, refer to the International Warranty.

Four Stroke Outboard Limited Warranty

UNITED STATES AND CANADA

Outside the United States and Canada - Check with your local distributor.

California residents that have purchased a 2001 model year outboard from a California dealer receive coverage in addition to that identified below for emissions related components. Please see the California Emission Warranty Statement provided by your dealer.

WHAT IS COVERED: Mercury Marine warrants its new products to be free of defects in material and workmanship during the period described below.

DURATION OF COVERAGE: This Limited Warranty provides coverage for three (3) years from the date the product is first sold to a recreational use retail purchaser, or the date on which the product is first put into service, whichever occurs first. Commercial users of these products receive warranty coverage of one (1) year from the date of first retail sale, or one (1) year from the date on which the product was first put into service, whichever occurs first. Commercial use is defined as any work or employment related use of the product, or any use of the product which generates income, for any part of the warranty period, even if the product is only occasionally used for such purposes. The repair or replacement of parts, or the performance of service under this warranty, does not extend the life of this warranty beyond its original expiration date. Unexpired warranty coverage can be transferred from one recreational use customer to a subsequent recreational use customer upon proper re-registration of the product. Unexpired warranty coverage cannot be transferred either to or from a commercial use customer.

WARRANTY INFORMATION

CONDITIONS THAT MUST BE MET IN ORDER TO OBTAIN WARRANTY COVERAGE: Warranty coverage is available only to retail customers that purchase from a Dealer authorized by Mercury Marine to distribute the product in the country in which the sale occurred, and then only after the Mercury Marine specified pre-delivery inspection process is completed and documented. Warranty coverage becomes available upon proper registration of the product by the authorized dealer. Inaccurate warranty registration information regarding recreational use, or subsequent change of use from recreational to commercial (unless properly re-registered) may void the warranty at the sole discretion of Mercury Marine. Routine maintenance outlined in the Operation and Maintenance Manual must be timely performed in order to maintain warranty coverage. Mercury Marine reserves the right to make warranty coverage contingent upon proof of proper maintenance.

WHAT MERCURY WILL DO: Mercury's sole and exclusive obligation under this warranty is limited to, at our option, repairing a defective part, replacing such part or parts with new or Mercury Marine certified re-manufactured parts, or refunding the purchase price of the Mercury product. Mercury reserves the right to improve or modify products from time to time without assuming an obligation to modify products previously manufactured.

HOW TO OBTAIN WARRANTY COVERAGE: The customer must provide Mercury with a reasonable opportunity to repair, and reasonable access to the product for warranty service. Warranty claims shall be made by delivering the product for inspection to a Mercury dealer authorized to service the product. If purchaser cannot deliver the product to such a dealer, written notice must be given to Mercury. We will then arrange for the inspection and any covered repair. Purchaser in that case shall pay for all related transportation charges and/or travel time. If the service provided is not covered by this warranty, purchaser shall pay for all related labor and material, and any other expenses associated with that service. Purchaser shall not, unless requested by Mercury, ship the product or parts of the product directly to Mercury. Proof of registered ownership must be presented to the dealer at the time warranty service is requested in order to obtain coverage.

U.S. EPA EMISSIONS LIMITED WARRANTY: Consistent with the obligations created by 40 CFR Part 91, Subpart M, Mercury Marine provides a two year limited warranty to the retail purchaser, that the engine is designed, built, and equipped so as to conform at the time of sale with applicable regulations under section 213 of the Clean Air Act, and that the engine is free from defects in materials and workmanship which cause the engine to fail to conform with applicable regulations.

WARRANTY INFORMATION

WHAT IS NOT COVERED: This limited warranty does not cover routine maintenance items, tune ups, adjustments, normal wear and tear, damage caused by abuse, abnormal use, use of a propeller or gear ratio that does not allow the engine to run in its recommended wide open throttle RPM range (see the Operation and Maintenance Manual), operation of the product in a manner inconsistent with the recommended operation/duty cycle section of the Operation and maintenance Manual, neglect, accident, submersion, improper installation (proper installation specifications and techniques are set forth in the installation instructions for the product), improper service, use of an accessory or part not manufactured or sold by us, jet pump impellers and liners, operation with fuels, oils or lubricants which are not suitable for use with the product (see the Operation and Maintenance Manual), alteration or removal of parts, water entering the engine through the fuel intake, air intake or exhaust system, or damage to the product from insufficient cooling water caused by blockage of the cooling system by a foreign body, running the engine out of water, mounting the engine too high on the transom, or running the boat with the engine trimmed out too far. Use of the product for racing or other competitive activity, or operating with a racing type lower unit, at any point, even by a prior owner of the product, voids the warranty.

Expenses related to haul out, launch, towing, storage, telephone, rental, inconvenience, slip fees, insurance coverage, loan payments, loss of time, loss of income, or any other type of incidental or consequential damages are not covered by this warranty. Also, expenses associated with the removal and/or replacement of boat partitions or material caused by boat design for access to the product are not covered by this warranty.

No individual or entity, including Mercury Marine authorized dealers, has been given authority by Mercury Marine to make any affirmation, representation or warranty regarding the product, other than those contained in this limited warranty, and if made, shall not be enforceable against Mercury Marine.

For additional information regarding events and circumstances covered by this warranty, and those that are not, see the Warranty Coverage section of the Operation and Maintenance Manual, incorporated by reference into this warranty.

WARRANTY INFORMATION

DISCLAIMERS AND LIMITATIONS:

THE IMPLIED WARRANTIES OF MERCHANTABILITY AND FITNESS FOR A PARTICULAR PURPOSE ARE EXPRESSLY DISCLAIMED. TO THE EXTENT THAT THEY CANNOT BE DISCLAIMED, THE IMPLIED WARRANTIES ARE LIMITED IN DURATION TO THE LIFE OF THE EXPRESS WARRANTY. INCIDENTAL AND CONSEQUENTIAL DAMAGES ARE EXCLUDED FROM COVERAGE UNDER THIS WARRANTY. SOME STATES/COUNTRIES DO NOT ALLOW FOR THE DISCLAIMERS, LIMITATIONS AND EXCLUSIONS IDENTIFIED ABOVE, AS A RESULT, THEY MAY NOT APPLY TO YOU. THIS WARRANTY GIVES YOU SPECIFIC LEGAL RIGHTS, AND YOU MAY ALSO HAVE OTHER LEGAL RIGHTS WHICH VARY FROM STATE TO STATE AND COUNTRY TO COUNTRY.

3 Year Limited Warranty Against Corrosion

WHAT IS COVERED: Mercury Marine warrants that each new Mercury, Mariner, Mercury Racing, Sport Jet, M² Jet Drive, Tracker by Mercury Marine Outboard, MerCruiser Inboard or sterndrive engine (Product) will not be rendered inoperative as a direct result of corrosion for the period of time described below.

DURATION OF COVERAGE: This limited corrosion warranty provides coverage for three (3) years from either the date the product is first sold, or the date on which the product is first put into service, whichever occurs first. The repair or replacement of parts, or the performance of service under this warranty does not extend the life of this warranty beyond its original expiration date. Unexpired warranty coverage can be transferred to subsequent (noncommercial use) purchaser upon proper re-registration of the product.

WARRANTY INFORMATION

CONDITIONS THAT MUST BE MET IN ORDER TO OBTAIN WARRANTY COVERAGE: Warranty coverage is available only to retail customers that purchase from a Dealer authorized by Mercury Marine to distribute the product in the country in which the sale occurred, and then only after the Mercury Marine specified pre-delivery inspection process is completed and documented. Warranty coverage becomes available upon proper registration of the product by the authorized dealer. Corrosion prevention devices specified in the Operation and Maintenance Manual must be in use on the boat, and routine maintenance outlined in the Operation and Maintenance Manual must be timely performed (including without limitation the replacement of sacrificial anodes, use of specified lubricants, and touch-up of nicks and scratches) in order to maintain warranty coverage. Mercury Marine reserves the right to make warranty coverage contingent upon proof of proper maintenance.

WHAT MERCURY WILL DO: Mercury's sole and exclusive obligation under this warranty is limited to, at our option, repairing a corroded part, replacing such part or parts with new or Mercury Marine certified re-manufactured parts, or refunding the purchase price of the Mercury product. Mercury reserves the right to improve or modify products from time to time without assuming an obligation to modify products previously manufactured.

HOW TO OBTAIN WARRANTY COVERAGE: The customer must provide Mercury with a reasonable opportunity to repair, and reasonable access to the product for warranty service. Warranty claims shall be made by delivering the product for inspection to a Mercury dealer authorized to service the product. If purchaser cannot deliver the product to such a dealer, written notice must be given to Mercury. We will then arrange for the inspection and any covered repair. Purchaser in that case shall pay for all related transportation charges and/or travel time. If the service provided is not covered by this warranty, purchaser shall pay for all related labor and material, and any other expenses associated with that service. Purchaser shall not, unless requested by Mercury, ship the product or parts of the product directly to Mercury. Proof of registered ownership must be presented to the dealer at the time warranty service is requested in order to obtain coverage.

WARRANTY INFORMATION

WHAT IS NOT COVERED: This limited warranty does not cover electrical system corrosion; corrosion resulting from damage, corrosion which causes purely cosmetic damage, abuse or improper service; corrosion to accessories, instruments, steering systems; corrosion to factory installed jet drive unit; damage due to marine growth; product sold with less than a one year limited Product warranty; replacement parts (parts purchased by customer); products used in a commercial application. Commercial use is defined as any work or employment related use of the product, or any use of the product which generates income, for any part of the warranty period, even if the product is only occasionally used for such purposes.

Corrosion damage caused by stray electrical currents (on-shore power connections, nearby boats, submerged metal) is not covered by this corrosion warranty and should be protected against by the use of a corrosion protection system, such as the Mercury Precision Parts or Quicksilver MerCathode system and/or Galvanic Isolator. Corrosion damage caused by improper application of copper base anti-fouling paints is also not covered by this limited warranty. If anti-fouling protection is required, Tri-Butyl-Tin-Adipate (TBTA) base anti-fouling paints are recommended on Outboard and MerCruiser boating applications. In areas where TBTA base paints are prohibited by law, copper base paints can be used on the hull and transom. Do not apply paint to the outboard or MerCruiser product. In addition, care must be taken to avoid an electrical interconnection between the warranted product and the paint. For MerCruiser product, an unpainted gap of at least 38 mm (1.5 in.) should be left around the transom assembly. Refer to the Operation and Maintenance Manual for additional details.

For additional information regarding events and circumstances covered by this warranty, and those that are not, see the Warranty Coverage section of the Operation and Maintenance Manual, incorporated by reference into this warranty.

WARRANTY INFORMATION

DISCLAIMERS AND LIMITATIONS:

THE IMPLIED WARRANTIES OF MERCHANTABILITY AND FITNESS FOR A PARTICULAR PURPOSE ARE EXPRESSLY DISCLAIMED. TO THE EXTENT THAT THEY CANNOT BE DISCLAIMED, THE IMPLIED WARRANTIES ARE LIMITED IN DURATION TO THE LIFE OF THE EXPRESS WARRANTY. INCIDENTAL AND CONSEQUENTIAL DAMAGES ARE EXCLUDED FROM COVERAGE UNDER THIS WARRANTY. SOME STATES/COUNTRIES DO NOT ALLOW FOR THE DISCLAIMERS, LIMITATIONS AND EXCLUSIONS IDENTIFIED ABOVE, AS A RESULT, THEY MAY NOT APPLY TO YOU. THIS WARRANTY GIVES YOU SPECIFIC LEGAL RIGHTS, AND YOU MAY ALSO HAVE OTHER LEGAL RIGHTS WHICH VARY FROM STATE TO STATE AND COUNTRY TO COUNTRY.

Warranty Coverage And Exclusions

The purpose of this section is to help eliminate some of the more common misunderstandings regarding warranty coverage. The following information explains some of the types of services that are not covered by warranty. The provisions set forth following have been incorporated by reference into the Three Year Limited Warranty Against Corrosion Failure, the International Limited Outboard Warranty, and the United States and Canada Limited Outboard Warranty.

Keep in mind that warranty covers repairs that are needed within the warranty period because of defects in material and workmanship. Installation errors, accidents, normal wear, and a variety of other causes that affect the product are not covered.

Warranty is limited to defects in material or workmanship, but only when the consumer sale is made in the country to which distribution is authorized by us.

Should you have any questions concerning warranty coverage, contact your authorized dealer. They will be pleased to answer any questions that you may have.

GENERAL EXCLUSIONS FROM WARRANTY

1. Minor adjustments and tune-ups, including checking, cleaning or adjusting spark plugs, ignition components, carburetor settings, filters, belts, controls, and checking lubrication made in connection with normal services.

WARRANTY INFORMATION

2. Factory installed jet drive units - Specific parts excluded from the warranty are: The jet drive impeller and jet drive liner damaged by impact or wear, and water damaged drive shaft bearings as a result of improper maintenance.
3. Damage caused by neglect, lack of maintenance, accident, abnormal operation or improper installation or service.
4. Haul out, launch, towing charges, removal and/or replacement of boat partitions or material because of boat design for necessary access to the product, all related transportation charges and/or travel time, etc. Reasonable access must be provided to the product for warranty service. Customer must deliver product to an authorized dealer.
5. Additional service work requested by customer other than that necessary to satisfy the warranty obligation.
6. Labor performed by other than an authorized dealer may be covered only under following circumstances: When performed on emergency basis (providing there are no authorized dealers in the area who can perform the work required or have no facilities to haul out, etc., and prior factory approval has been given to have the work performed at this facility).
7. All incidental and/or consequential damages (storage charges, telephone or rental charges of any type, inconvenience or loss of time or income) are the owner's responsibility.
8. Use of other than Mercury Precision or Quicksilver parts when making warranty repairs.
9. Oils, lubricants or fluids changed as a matter of normal maintenance is customer's responsibility unless loss or contamination of same is caused by product failure that would be eligible for warranty consideration.
10. Participating in or preparing for racing or other competitive activity or operating with a racing type lower unit.
11. Engine noise does not necessarily indicate a serious engine problem. If diagnosis indicates a serious internal engine condition which could result in a failure, condition responsible for noise should be corrected under the warranty.
12. Lower unit and/or propeller damage caused by striking a submerged object is considered a marine hazard.
13. Water entering engine through the fuel intake, air intake or exhaust system or submersion.

WARRANTY INFORMATION

14. Failure of any parts caused by lack of cooling water, which results from starting motor out of water, foreign material blocking inlet holes, motor being mounted too high or trimmed too far out.
15. Use of fuels and lubricants which are not suitable for use with or on the product. Refer to the **Maintenance** section.
16. Our limited warranty does not apply to any damage to our products caused by the installation or use of parts and accessories which are not manufactured or sold by us. Failures which are not related to the use of those parts or accessories are covered under warranty if they otherwise meet the terms of the limited warranty for that product.

California Emissions Limited Warranty

The California Air Resources Board has promulgated air emissions regulations for outboard engines. The regulations apply to all outboard engines sold to retail consumers in California, and which were manufactured for the 2001 model year, and later. Mercury Marine, in compliance with those regulations, provides this limited warranty for the emission control systems (see the components of the emission control system listed following), and further warrants that the outboard engine was designed, built and equipped to conform with all applicable regulations adopted by the California Air Resources Board pursuant to its authority in Chapters 1 and 2, Part 5, Division 26 of the Health and Safety Code. For information regarding the limited warranty for the non emissions related components of the outboard, please see the limited warranty statement for your outboard.

WHAT IS COVERED: Mercury Marine warrants the components of the emissions control systems (see the components of the emission control system listed following) of its new, 2001 model year (and later) outboards, sold by a California dealer to retail customers residing in California, to be free from defects in material or workmanship, that cause the failure of a warranted part to be identical in all material respects to that part as described in the application of Mercury Marine for certification from the California Air Resources Board, for the period of time, and under the conditions, identified below. The cost to diagnose a warranty failure is covered under the warranty (if the warranty claim is approved). Damage to other engine components caused by the failure of a warranted part will also be repaired under warranty.

WARRANTY INFORMATION

DURATION OF COVERAGE: This limited warranty provides coverage for the components of the emissions control systems of new, 2001 model year (and later) outboards, sold to retail customers in California for 4 years from either the date the product is first sold, or first put into service, whichever occurs first, or the accumulation of 250 hours of engine operation (as determined by the engines hour meter, if any). Emission related normal maintenance items such as spark plugs and filters, that are on the warranted parts list (see following) are warranted up to their first required replacement interval only. (See **Maintenance - Inspection and Maintenance Schedule**). The repair or replacement of parts, or the performance of service under this warranty, does not extend the life of this warranty beyond its original expiration date. Unexpired warranty coverage can be transferred to a subsequent purchaser. (See instructions on transfer of warranty).

HOW TO OBTAIN WARRANTY COVERAGE: The customer must provide Mercury with a reasonable opportunity to repair, and reasonable access to the product for warranty service. Warranty claims shall be made by delivering the product for inspection to a Mercury dealer authorized to service the product. If purchaser cannot deliver the product to such a dealer, please notify Mercury Marine and Mercury will then arrange for the inspection and any covered repair. Purchaser in that case shall pay for all related transportation charges and/or travel time. If the service provided is not covered by this warranty, purchaser shall pay for all related labor and material, and any other expenses associated with that service. Purchaser shall not, unless requested by Mercury, ship the product or parts of the product directly to Mercury.

WHAT MERCURY WILL DO: Mercury Marine's sole and exclusive obligation under this warranty is limited to, at our expense and at our option, repairing or replacing defective parts with new or Mercury Marine certified re-manufactured parts, or refunding the purchase price of the Mercury product. Mercury reserves the right to improve or modify products from time to time without assuming an obligation to modify products previously manufactured.

WARRANTY INFORMATION

WHAT IS NOT COVERED: This limited warranty does not cover routine maintenance items, tune ups, adjustments, normal wear and tear, damage caused by abuse, abnormal use, use of a propeller or gear ratio that does not allow the engine to run in its recommended wide open throttle RPM range (see **General Information - Specifications**), operation of the product in a manner inconsistent with the recommended operation procedures, neglect, accident, submersion, improper installation (proper installation specifications and techniques are set forth in the installation instructions for the product), improper service, use of an accessory or part not manufactured or sold by us, jet pump impellers and liners, operation with fuels, oils or lubricants which are not suitable for use with the product (see **Fuel and Oil**), alteration or removal of parts, or water entering the engine through the fuel intake, air intake or exhaust system. Use of the product for racing or other competitive activity, or operating with a racing type lower unit, at any point, even by a prior owner of the product, voids the warranty.

Expenses related to haul out, launch, towing, storage, telephone, rental, inconvenience, slip fees, insurance coverage, loan payments, loss of time, loss of income, or any other type of incidental or consequential damages are not covered by this warranty. Also, expenses associated with the removal and/or replacement of boat partitions or material caused by boat design for access to the product are not covered by this warranty.

Non-warranty maintenance, replacement, or repair of emission control devices and systems may be performed by any marine engine repair establishment or individual. The use of non-Mercury parts for non-warranty maintenance or repairs will not be grounds for disallowing other warranty work. The use of add-on (as defined at section 1900 (b)(1) and (b)(10) of Title 13 of the California Code of Regulations) or modified parts not exempted by the California Air Resources Board may be grounds for disallowing a warranty claim, at the discretion of Mercury Marine. Failures of warranted parts caused by the use of a non-exempted add-on or modified part will not be covered.

COMPONENTS OF THE EMISSIONS CONTROL SYSTEM:

1. Fuel Metering System
 - a. Carburetor and internal parts (and/or pressure regulator or fuel injection system)
 - b. Cold start enrichment system
 - c. Intake valves
2. Air Induction System
 - a. Intake manifold

WARRANTY INFORMATION

- b. Turbocharger systems (where applicable)
- 3. Ignition System
 - a. Spark plugs
 - b. Magneto or electronic ignition system
 - c. Spark advance/retard system
 - d. Ignition coil and/or control module
 - e. Ignition wires
- 4. Lubrication System (4-Stroke engines excluded)
 - a. Oil pump and internal parts
 - b. Oil injectors
 - c. Oil meter
- 5. Exhaust system
 - a. Exhaust manifold
 - b. Exhaust valves
- 6. Miscellaneous Items Used in Above Systems
 - a. Hoses, clamps, fittings, tubing, sealing gaskets or devices, and mounting hardware.
 - b. Pulleys, belts and idlers.
 - c. Vacuum, temperature, check and time sensitive valves and switches
 - d. Electronic controls.

DISCLAIMERS AND LIMITATIONS

THE IMPLIED WARRANTIES OF MERCHANTABILITY AND FITNESS FOR A PARTICULAR PURPOSE ARE EXPRESSLY DISCLAIMED. TO THE EXTENT THAT THEY CANNOT BE DISCLAIMED, THE IMPLIED WARRANTIES ARE LIMITED IN DURATION TO THE LIFE OF THE EXPRESS WARRANTY. INCIDENTAL AND CONSEQUENTIAL DAMAGES ARE EXCLUDED FROM COVERAGE UNDER THIS WARRANTY. SOME STATES/COUNTRIES DO NOT ALLOW FOR THE DISCLAIMERS, LIMITATIONS AND EXCLUSIONS IDENTIFIED ABOVE, AS A RESULT, THEY MAY NOT APPLY TO YOU. THIS WARRANTY GIVES YOU SPECIFIC LEGAL RIGHTS, AND YOU MAY ALSO HAVE OTHER LEGAL RIGHTS WHICH VARY FROM STATE TO STATE AND COUNTRY TO COUNTRY.

If you have any questions regarding your warranty rights and responsibilities, you should contact Mercury Marine at 1-920-929-5040.

WARRANTY INFORMATION

CALIFORNIA AIR RESOURCES BOARD EXPLANATION OF YOUR CALIFORNIA EMISSION CONTROL WARRANTY STATEMENT

YOUR WARRANTY RIGHTS AND OBLIGATIONS: The California Air Resources Board is pleased to explain the emission control system warranty on your 2001 model year and later outboard engine. In California, new outboard engines must be designed, built and equipped to meet the State's stringent anti-smog standards. Mercury Marine must warrant the emission control system on your outboard engine for the periods of time listed below provided there has been no abuse, neglect or improper maintenance of your outboard engine.

Your emission control system may include parts such as the carburetor or fuel injection system, the ignition system, and catalytic converter. Also included may be hoses, belts, connectors and other emission-related assemblies.

Where a warrantable condition exists, Mercury Marine will repair your outboard engine at no cost to you, including diagnosis, parts and labor.

MANUFACTURER'S WARRANTY COVERAGE: Select emission control parts from model year 2001 and later outboard engines are warranted for 4 years, or for 250 hours of use, whichever occurs first. However, warranty coverage based on the hourly period is only permitted for outboard engines and personal watercraft equipped with appropriate hour meters or their equivalent. If any emission related part on your engine is defective under warranty, the part will be repaired or replaced by Mercury Marine.

OWNER'S WARRANTY RESPONSIBILITIES: As the outboard engine owner, you are responsible for the performance of the required maintenance listed in the Maintenance section. Mercury Marine recommends that you retain all receipts covering maintenance on your outboard engine, but Mercury Marine cannot deny warranty solely for the lack of receipts or your failure to ensure the performance of all scheduled maintenance.

As the outboard engine owner, you should however be aware that Mercury Marine may deny you warranty coverage if your outboard engine or a part has failed due to abuse, neglect, improper maintenance or unapproved modifications.

You are responsible for presenting your outboard to a Mercury dealer authorized to service the product as soon as a problem exists. The warranty repairs will be completed in a reasonable amount of time, not to exceed 30 days.

WARRANTY INFORMATION

If you have any questions regarding your warranty rights and responsibilities, you should contact Mercury Marine at 1-920-929-5040.

Star Label



Outboards are labeled on the cowl with one of the following star labels.

The Symbol for Cleaner Marine Engines Means:

Cleaner Air and Water - for a healthier lifestyle and environment.

Better Fuel Economy - burns up to 30-40 percent less gas and oil than conventional carbureted two-stroke engines, saving money and resources.

Longer Emission Warranty - Protects consumer for worry free operation.

 <p>ob00708</p>	<p>One Star - Low Emission</p> <p>The one Star Label identifies engines that meet the Air Resources Board's 2001 exhaust emissions standards. Engines meeting these standards have 75% lower emissions than conventional carbureted two-stroke engines. These engines are equivalent to the U.S. EPA's 2006 standards for marine engines.</p>
 <p>ob00709</p>	<p>Two Stars - Very Low Emission</p> <p>The two Star Label identifies engines that meet the Air Resources Board's Personal Watercraft and Outboard marine engine 2004 exhaust emissions standards. Engines meeting these standards have 20% lower emissions than One Star - Low Emission engines.</p>
 <p>ob00710</p>	<p>Three Stars - Ultra Low Emission</p> <p>The three Star Label identifies engines that meet the Air Resources Board's personal Watercraft and Outboard marine engine 2008 exhaust emissions standards or the Sterndrive and Inboard marine engine 2003-2008 exhaust emission standards. Engines meeting these standards have 65% lower emissions than One Star - Low Emission engines.</p>

WARRANTY INFORMATION



ob00711

Four Stars - Super Ultra Low Emission

The four Star label identifies engines that meet the Air Resources Board's Sterndrive and Inboard marine engine 2009 exhaust emission standards. Personal Watercraft and Outboard marine engines may also comply with these standards. Engines meeting these standards have 90% lower emissions than One Star - Low Emission engines.

GENERAL INFORMATION

Boater's Responsibilities

The operator (driver) is responsible for the correct and safe operation of the boat and safety of its occupants and general public. It is strongly recommended that each operator (driver) read and understand this entire manual before operating the outboard.

Be sure at least one additional person on board is instructed in the basics of starting and operating the outboard and boat handling in case the driver is unable to operate the boat.

Before Operating Your Outboard

Read this manual carefully. Learn how to operate your outboard properly. If you have any questions, contact your dealer.

Safety and operating information that is practiced, along with using good common sense, can help prevent personal injury and product damage.

This manual as well as safety labels posted on the outboard use the following safety alerts to draw your attention to special safety instructions that should be followed.

DANGER

DANGER - indicates an imminently hazardous situation that, if not avoided, will result in death or serious injury.

WARNING

WARNING - indicates a potentially hazardous situation that, if not avoided, could result in death or serious injury.

CAUTION

CAUTION - indicates a potentially hazardous situation that, if not avoided, may result in minor or moderate injury or property damage. It may also be used to alert against unsafe practices.

Boat Horsepower Capacity

WARNING

Using an outboard that exceeds the maximum horsepower limit of a boat can: 1) cause loss of boat control 2) place too much weight at the transom altering the designed flotation characteristics of the boat or 3) cause the boat to break apart particularly around the transom area. Overpowering a boat can result in serious injury, death or boat damage.

GENERAL INFORMATION

Do not overpower or overload your boat. Most boats will carry a required capacity plate indicating the maximum acceptable power and load as determined by the manufacturer following certain federal guidelines. If in doubt, contact your dealer or the boat manufacturer.

U.S. COAST GUARD CAPACITY	
MAXIMUM HORSEPOWER	XXX
MAXIMUM PERSON CAPACITY (POUNDS)	XXX
MAXIMUM WEIGHT CAPACITY	XXX

ob00306

High-Speed And High-Performance Boat Operation

If your outboard is to be used on a high speed or high performance boat with which you are unfamiliar, we recommend that you never operate it at its high speed capability without first requesting an initial orientation and familiarization demonstration ride with your dealer or an operator experienced with your boat/outboard combination. For additional information, obtain a copy of our **Hi-Performance Boat Operation** booklet (part number 90-848481) from your dealer, distributor, or Mercury Marine.

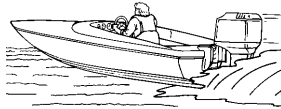

ob00307

Outboard Remote Control Models

The remote control connected to your outboard must be equipped with a start in neutral only protection device. This prevents the engine from starting when the shift is actuated in any position other than neutral.

GENERAL INFORMATION

⚠ WARNING

Avoid serious injury or death from a sudden unexpected acceleration when starting your engine. The design of this outboard requires that the remote control used with it must have a built in start in neutral only protection device.

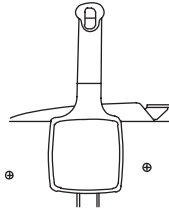

ob00308

Remote Steering Notice

The steering link rod that connects the steering cable to the engine must be fastened utilizing self-locking nuts. These self-locking nuts must never be replaced with common nuts (non-locking) as they will work loose and vibrate off, freeing the link rod to disengage.

⚠ WARNING

Disengagement of a steering link rod can result in the boat taking a full, sudden, sharp turn. This potentially violent action can cause occupants to be thrown overboard exposing them to serious injury or death.

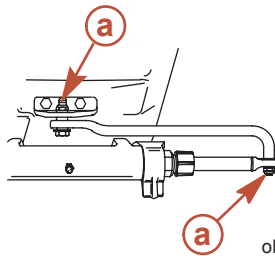

ob00309

a - Self-locking nuts

GENERAL INFORMATION

Lanyard Stop Switch

The purpose of a lanyard stop switch is to turn off the engine when the operator moves far enough away from the operator's position (as in accidental ejection from the operator's position) to activate the switch. Tiller handle outboards and some remote control units are equipped with a lanyard stop switch. A lanyard stop switch can be installed as an accessory - generally on the dashboard or side adjacent to the operator's position.

The lanyard is a cord usually between 122 and 152 cm (4 and 5 feet) in length when stretched out, with an element on one end made to be inserted into the switch and a snap on the other end for attaching to the operator. The lanyard is coiled to make its at-rest condition as short as possible to minimize the likelihood of lanyard entanglement with nearby objects. Its stretched-out length is made to minimize the likelihood of accidental activation should the operator choose to move around in an area close to the normal operator's position. If it is desired to have a shorter lanyard, wrap the lanyard around the operator's wrist or leg, or tie a knot in the lanyard.

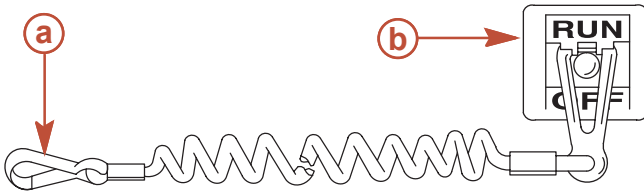

ob00310

a - Lanyard cord

b - Lanyard stop switch

Read the following Safety Information before proceeding.

GENERAL INFORMATION

Important Safety Information: The purpose of a lanyard stop switch is to stop the engine when the operator moves far enough away from the operator's position to activate the switch. This would occur if the operator accidentally falls overboard or moves within the boat a sufficient distance from the operator's position. Falling overboard and accidental ejections are more likely to occur in certain types of boats such as low sided inflatables, bass boats, high performance boats, and light, sensitive handling fishing boats operated by a hand tiller. Falling overboard and accidental ejections are also likely to occur as a result of poor operating practices such as sitting on the back of the seat or gunwale at planing speeds, standing at planing speeds, sitting on elevated fishing boat decks, operating at planing speeds in shallow or obstacle infested waters, releasing your grip on a steering wheel or tiller handle that is pulling in one direction, drinking alcohol or consuming drugs, or daring, high speed boat maneuvers.

While activation of the lanyard stop switch will stop the engine immediately, a boat will continue to coast for some distance depending upon the velocity and degree of any turn at shut down. However, the boat will not complete a full circle. While the boat is coasting, it can cause injury to anyone in the boat's path as seriously as the boat would when under power.

We strongly recommend that other occupants be instructed on proper starting and operating procedures should they be required to operate the engine in an emergency (e.g. if the operator is accidentally ejected).

WARNING

Should the operator fall out of the boat, the possibility of serious injury or death from being run over by the boat can be greatly reduced by stopping the engine immediately. Always properly connect both ends of the stop switch lanyard to the stop switch and the operator.

WARNING

Avoid serious injury or death from deceleration forces resulting from accidental or unintended stop switch activation. The boat operator should never leave the operator's station without first disconnecting the stop switch lanyard from the operator.

GENERAL INFORMATION

Accidental or unintended activation of the switch during normal operation is also a possibility. This could cause any, or all, of the following potentially hazardous situations:

- Occupants could be thrown forward due to unexpected loss of forward motion - a particular concern for passengers in the front of the boat who could be ejected over the bow and possibly struck by the gearcase or propeller.
- Loss of power and directional control in heavy seas, strong current or high winds.
- Loss of control when docking.

Protecting People In The Water

WHILE YOU ARE CRUISING

It is very difficult for a person standing or floating in the water to take quick action to avoid a boat heading in his/her direction, even at slow speed.



ob00311

Always slow down and exercise extreme caution any time you are boating in an area where there might be people in the water.

Whenever a boat is moving (coasting) and the outboard gear shift is in neutral position, there is sufficient force by the water on the propeller to cause the propeller to rotate. This neutral propeller rotation can cause serious injury.

WHILE BOAT IS STATIONARY

WARNING

Stop your engine immediately whenever anyone in the water is near your boat. Serious injury to the person in the water is likely if contacted by a rotating propeller, a moving boat, a moving gearcase, or any solid device rigidly attached to a moving boat or gearcase.

Shift outboard into neutral and shut off the engine before allowing people to swim or be in the water near your boat.

GENERAL INFORMATION

Passenger Safety Message - Pontoon Boats And Deck Boats

Whenever the boat is in motion, observe the location of all passengers. Do not allow any passengers to stand or use seats other than those designated for traveling faster than idle speed. A sudden reduction in boat speed, such as plunging into a large wave or wake, a sudden throttle reduction, or a sharp change of boat direction, could throw them over the front of boat. Falling over the front of the boat between the two pontoons will position them to be run over by the outboard.

BOATS HAVING AN OPEN FRONT DECK

No one should ever be on the deck in front of the fence while the boat is in motion. Keep all passengers behind the front fence or enclosure.

Persons on the front deck could easily be thrown overboard or persons dangling their feet over the front edge could get their legs caught by a wave and pulled into the water.

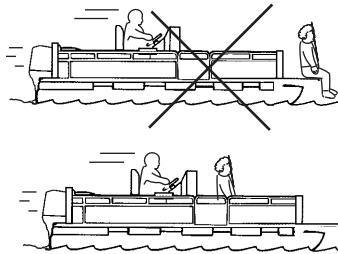

ob00312

WARNING

Avoid serious injury or death from falling over the front end of a pontoon or deck boat and being run over by the outboard. Stay back from the front end of the deck and remain seated while the boat is in motion.

BOATS WITH FRONT-MOUNTED, RAISED PEDESTAL FISHING SEATS

Elevated fishing seats are not intended for use when the boat is traveling faster than idle or trolling speed. Sit only in seats designated for traveling at faster speeds.

GENERAL INFORMATION

Any unexpected, sudden reduction in boat speed could result in the elevated passenger falling over the front of the boat.

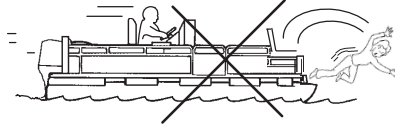

ob00313

Wave And Wake Jumping

Operating recreational boats over waves and wake is a natural part of boating. However, when this activity is done with sufficient speed to force the boat hull partially or completely out of the water, certain hazards arise, particularly when the boat re-enters the water.

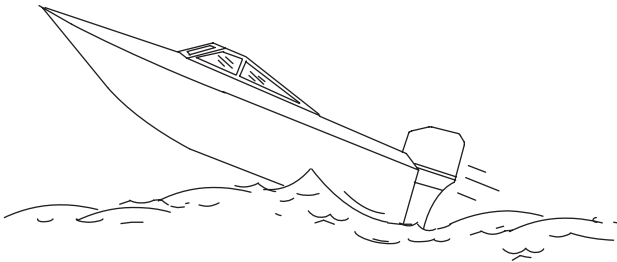

ob00314

The primary concern is the boat changing direction while in the midst of the jump. In such case the landing may cause the boat to veer violently in a new direction. Such a sharp change in direction can cause occupants to be thrown out of their seats, or out of the boat.

WARNING

Avoid serious injury or death from being thrown within or out of a boat when it lands after jumping a wave or wake. Avoid wave or wake jumping whenever possible. Instruct all occupants that if a wake or wave jump occurs, get low and hang on to a boat hand hold.

There is another less common hazardous result from allowing your boat to launch off a wave or wake. If the bow of your boat pitches down far enough while airborne, upon water contact it may penetrate under the water surface and submarine for an instant. This will bring the boat to a nearly instantaneous stop and can send the occupants flying forward. The boat may also steer sharply to one side.

GENERAL INFORMATION

Impact With Underwater Hazards

Reduce speed and proceed with caution whenever you drive a boat in shallow water areas, or in areas where you suspect underwater obstacles may exist which could be struck by the outboard or the boat bottom. **The most important thing you can do to help reduce injury or impact damage from striking a floating or underwater object is to control the boat speed. Under these conditions, boat speed should be kept to a minimum planing speed 24 to 40 km/h (15 to 25 MPH) .**

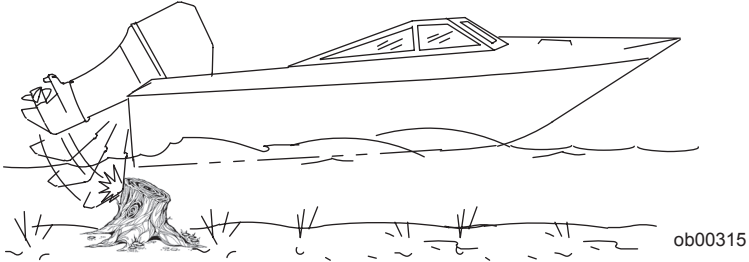

⚠ WARNING

To avoid serious injury or death from all or part of an outboard coming into the boat after striking a floating or underwater obstacle maintain a top speed no greater than minimum planing speed.

Striking a floating or underwater object could result in an infinite number of situations. Some of these situations could result in the following:

- Part of the outboard or the entire outboard could break loose and fly into the boat.
- The boat could move suddenly in a new direction. Such a sharp change in direction can cause occupants to be thrown out of their seats or out of the boat.
- A rapid reduction in speed. This will cause occupants to be thrown forward, or even out of the boat.
- Impact damage to the outboard and/or boat.

Keep in mind, the most important thing you can do to help reduce injury or impact damage during an impact is control the boat speed. Boat speed should be kept to a minimum planing speed when driving in waters known to have underwater obstacles.

After striking a submerged object, stop the engine as soon as possible and inspect it for any broken or loose parts. If damage is present or suspected, the outboard should be taken to an authorized dealer for a thorough inspection and necessary repair.

GENERAL INFORMATION

The boat should also be checked for any hull fractures, transom fractures, or water leaks.

Operating a damaged outboard could cause additional damage to other parts of the outboard, or could affect control of the boat. If continued running is necessary, do so at greatly reduced speeds.

WARNING

Avoid serious injury or death from loss of boat control. Continued boating with major impact damage can result in sudden outboard component failure with or without subsequent impacts. Have the outboard thoroughly inspected and any necessary repairs made.

Safety Instructions For Hand Tilled Outboards

No person or cargo should occupy the area directly in front of the outboard while the boat is in motion. If an underwater obstacle is struck, the outboard will tilt up and could seriously injure anyone occupying this area.

MODELS WITH CLAMP SCREWS:

Some outboards come with transom bracket clamp screws. The use of clamp bracket screws alone, is insufficient to properly and safely secure the outboard to the transom. Proper installation of the outboard includes bolting the engine to the boat through the transom. Refer to **Installation - Installing Outboard** for more complete installation information.

WARNING

Avoid serious injury or death from being struck by a disconnected outboard. Do not accelerate above idle speed in water suspected of containing underwater obstacles if the outboard is not attached to the transom correctly.

If an obstacle is struck at planing speed and the outboard is not securely fastened to the transom, it is possible the outboard could lift off the transom and land in the boat.

Exhaust Emissions

BE ALERT TO CARBON MONOXIDE POISONING

Carbon monoxide is present in the exhaust fumes of all internal combustion engines. This includes the outboards, sterndrives and inboard engines that propel boats, as well as the generators that power various boat accessories. Carbon monoxide is a deadly gas that is odorless, colorless and tasteless.

GENERAL INFORMATION

Early symptoms of carbon monoxide poisoning which should not be confused with seasickness or intoxication, include headache, dizziness, drowsiness, and nausea.

WARNING

Avoid the combination of a running engine and poor ventilation. Prolonged exposure to carbon monoxide in sufficient concentration can lead to unconsciousness, brain damage, or death.

GOOD VENTILATION

Ventilate passenger area, open side curtains, or forward hatches to remove fumes.

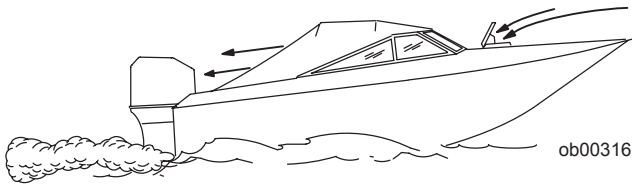

Example of desired air flow through the boat.

POOR VENTILATION

Under certain running and/or wind conditions, permanently enclosed or canvas enclosed cabins or cockpits with insufficient ventilation may draw in carbon monoxide. Install one or more carbon monoxide detectors in your boat.

Although the occurrence is rare, on a very calm day, swimmers and passengers in an enclosed area of a stationary boat that contains or is near a running engine may be exposed to a hazardous level of carbon monoxide.

WHILE BOAT IS STATIONARY

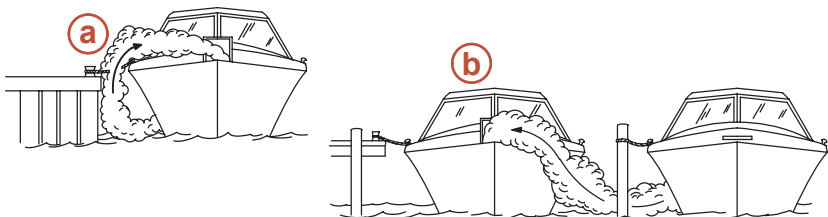

- a** - Running the engine when the boat is moored in a confined space.
- b** - Mooring close to another boat that has its engine running.

GENERAL INFORMATION

WHILE BOAT IS MOVING

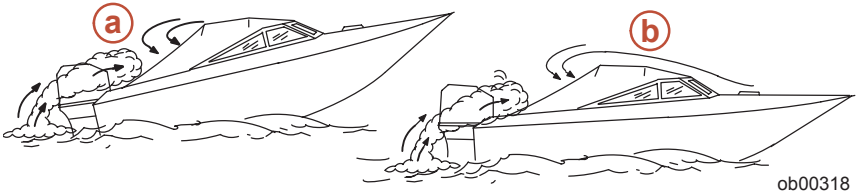

- a** - Running the boat with the trim angle of the bow too high.
- b** - Running the boat with no forward hatches open.

Selecting Accessories For Your Outboard

Genuine Mercury Precision or Quicksilver Accessories have been specifically designed and tested for your outboard. These accessories are available from Mercury Marine dealers.

WARNING

Check with your dealer before installation of accessories. The misuse of acceptable accessories or the use of unacceptable accessories can result in serious injury, death, or product failure.

Some accessories not manufactured or sold by Mercury Marine are not designed to be safely used with your outboard or outboard operating system. Acquire and read the installation, operation, and maintenance manuals for all your selected accessories.

Safe Boating Suggestions

In order to safely enjoy the waterways, familiarize yourself with local and other governmental boating regulations and restrictions, and consider the following suggestions.

Use flotation devices. Have an approved personal flotation device of suitable size for each person aboard (it is the law) and have it readily accessible.

Do not overload your boat. Most boats are rated and certified for maximum load (weight) capacities (refer to your boat capacity plate). If in doubt, contact your dealer or the boats manufacturer.

Perform safety checks and required maintenance. Follow a regular schedule and ensure that all repairs are properly made.

GENERAL INFORMATION

Know and obey all nautical rules and laws of the waterways. Boat operators should complete a boating safety course. Courses are offered in the U.S.A. by 1) The U.S. Coast Guard Auxiliary, 2) The Power Squadron, 3) The Red Cross and 4) your state boating law enforcement agency. Inquiries may be made to the Boating Hotline, 1-800-368-5647 or the Boat U.S. Foundation information number 1-800-336-BOAT.

Make sure everyone in the boat is properly seated. Do not allow anyone to sit or ride on any part of the boat that was not intended for such use. This includes the back of seats, gunwales, transom, bow, decks, raised fishing seats, any rotating fishing seat; or anywhere that an unexpected acceleration, sudden stopping, unexpected loss of boat control, or sudden boat movement could cause a person to be thrown overboard or into the boat.

Never be under the influence of alcohol or drugs while boating (it is the law). Alcohol or drug use impairs your judgment and greatly reduces your ability to react quickly.

Prepare other boat operators. Instruct at least one other person on board in the basics of starting and operating the outboard, and boat handling, in case the driver becomes disabled or falls overboard.

Passenger boarding. Stop the engine whenever passengers are boarding, unloading, or are near the back (stern) of the boat. Just shifting the outboard into neutral is not sufficient.

Be alert. The operator of the boat is responsible by law to maintain a proper lookout by sight and hearing. The operator must have an unobstructed view particularly to the front. No passengers, load, or fishing seats should block the operators view when operating the boat above idle speed.

Never drive your boat directly behind a water skier in case the skier falls. As an example, your boat traveling at 40 km/h (25 MPH) will overtake a fallen skier 61 m (200 ft.) in front of you in 5 seconds.

Watch fallen skiers. When using your boat for water skiing or similar activities, always keep a fallen or down skier on the operator's side of the boat while returning to assist the skier. The operator should always have the down skier in sight and never back up to the skier or anyone in the water.

GENERAL INFORMATION

Report accidents. Boat operators are required by law to file a Boating Accident Report with their state boating law enforcement agency when their boat is involved in certain boating accidents. A boating accident must be reported if 1) there is loss of life or probable loss of life, 2) there is personal injury requiring medical treatment beyond first aid, 3) there is damage to boats or other property where the damage value exceeds \$500.00 or 4) there is complete loss of the boat. Seek further assistance from local law enforcement.

Recording Serial Number

It is important to record this number for future reference. The serial number is located on the outboard as shown.

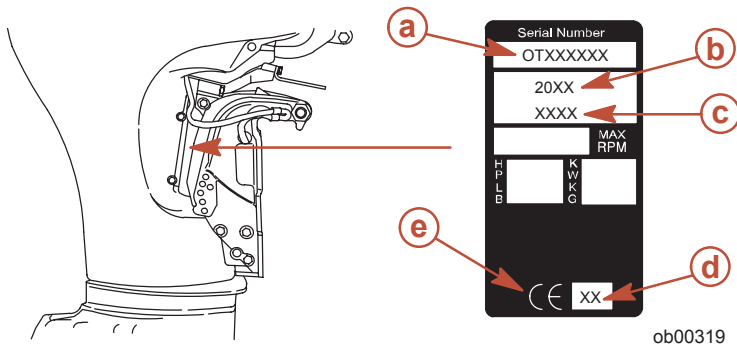

- a** - Serial number
- b** - Model year
- c** - Model designation

- d** - Year manufactured
- e** - Certified Europe Insignia (as applicable)

40/50/60 4-Stroke Specifications

Models	40	50	60
Horsepower	40	50	60
Kilowatts	29.8	37.7	44.7
Full Throttle RPM Range	5500-6000 RPM		
Number of Cylinders	4		
Idle Speed in Forward Gear	Controlled by ECM		
Piston Displacement	995 cc (60.8 cu. in.)		

GENERAL INFORMATION

Models	40	50	60
Cylinder Bore	65 mm (2.559 in.)		
Stroke	75 mm (2.953 in.)		
Valve Clearance (Cold)			
Intake Valve	0.15-0.25mm (0.006-0.010 in.)		
Exhaust Valve	0.25-0.35mm (0.010-0.014 in.)		
Recommended Spark Plug	Champion RA8HC		
Spark Plug Gap	1.0mm (0.040 in.)		
Gear Ratio			
83mm (3-1/4 in.) Diameter Gearcase	1.83:1		
108mm (4-1/4 in.) Diameter Gearcase	2.31:1 or 2.33:1		
Recommended Gasoline	Refer to Fuel & Oil		
Recommended Oil	Refer to Fuel & Oil		
Gearcase Lubricant Capacity			
83mm (3-1/4 in.) Diameter Gearcase	340 ml (11.5 fl. oz.)		
108mm (4-1/4 in.) Diameter Gearcase	710 ml (24.0 fl. oz.)		
Engine Oil Capacity	3.0 Liter (3 Quarts)		
Battery Rating			
Operation Above 0 °C (32 °F)	465 Marine Cranking Amps (MCA) or 350 Cold Cranking AMPS (CCA)		
Operation Below 0 °C (32 °F)	1000 Marine Cranking Amps (MCA) or 750 Cold Cranking AMPS (CCA)		
Ampere Hours (Ah)	70 -100		

GENERAL INFORMATION

Component Identification

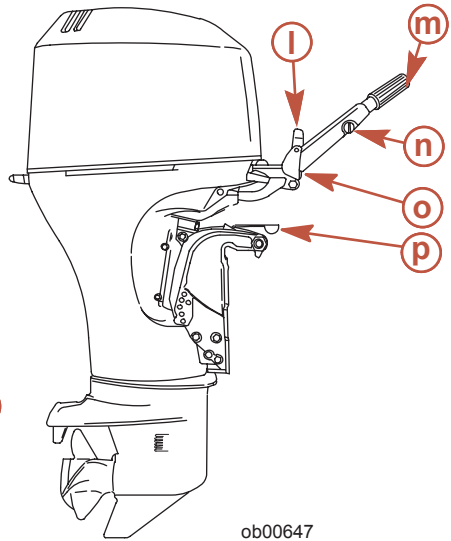
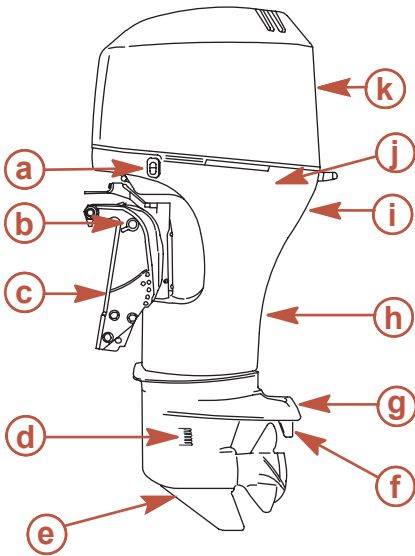

ob00647

- a** - Auxiliary tilt switch
- b** - Tilt support knob
- c** - Transom brackets
- d** - Primary cooling water intake
- e** - Gearcase
- f** - Trim tab
- g** - Anti-ventilation plate
- h** - Driveshaft housing

- i** - Water pump indicator hole
- j** - Bottom cowl
- k** - Top cowl
- l** - Shift handle
- m** - Engine stop switch
- n** - Throttle friction adjustment knob
- o** - Lanyard stop switch
- p** - Steering friction adjustment lever (tiller handle models)

INSTALLATION

Installing Outboard

WARNING

Before operation, the outboard must be correctly installed with the required mounting hardware as shown. Failure to correctly fasten outboard could result in outboard ejecting off boat transom causing serious injury, death, or property damage.

We strongly recommend that your dealer install your outboard and related accessories to ensure proper installation and good performance. If you install the outboard yourself, follow instructions in the Outboard Installation Manual which is provided with the outboard.

The outboard must be secured to the transom with the four 12.7 mm (1/2 in.) diameter mounting bolts and locknuts provided. Install two bolts through the upper set of holes and two bolts through the lower set of holes.

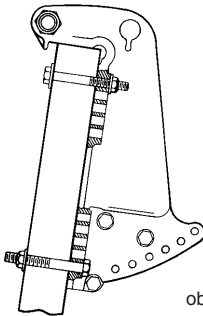

ob00658

MAXIMUM OUTBOARD MOUNTING HEIGHT

The mounting height of the outboard must not exceed 635 mm (25 in.) for EL models and 762 mm (30 in.) for EXL models. Mounting the outboard higher may cause damage to the gearcase components.

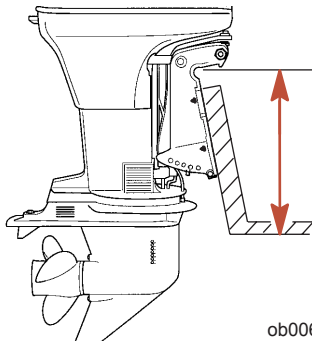

ob00659

INSTALLATION

Propeller Selection

For best all around performance from your outboard/boat combination, select a propeller that allows the engine to operate in the upper half of the recommended full throttle RPM range with the boat normally loaded (refer to **General Information - Specifications**). This RPM range allows for better acceleration while maintaining maximum boat speed.

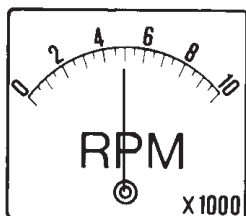

ob00323

If changing conditions cause the RPM to drop below the recommended range (such as warmer, more humid weather, operation at higher elevations, increased boat load, or a dirty boat bottom/gearcase), a propeller change or cleaning may be required to maintain performance and ensure the outboards durability.

Check full-throttle RPM, using an accurate tachometer, with the engine trimmed out to a balanced-steering condition (steering effort equal in both directions) without causing the propeller to break loose.

PROPELLER REQUIREMENTS - BIGFOOT MODELS

Bigfoot models require the use of specially designed rubber hub propellers to reduce both instances and severity of gearcase clutch rattle. The use of the other propellers, although not detrimental to either performance or durability, could result in clutch rattle.

TRANSPORTING

Trailing Boat/Outboard

Trail your boat with the outboard tilted down in a vertical operating position.

If additional ground clearance is required, the outboard should be tilted up using an accessory outboard support device. Refer to your local dealer for recommendations. Additional clearance may be required for railroad crossings, driveways and trailer bouncing.

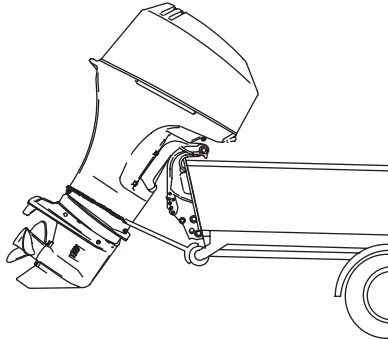

ob00324

IMPORTANT: Do not rely on the power trim/tilt system or tilt support lever to maintain proper ground clearance for trailering. The outboard tilt support lever is not intended to support the outboard for trailering.

Shift the outboard to forward gear. This prevents the propeller from spinning freely.

Transporting Portable Fuel Tanks

WARNING

Avoid serious injury or death from a gasoline fire or explosion. Follow portable fuel tank transporting instructions. Transport the fuel tank in a well ventilated area away from open flame or sparks.

MANUAL VENTING TYPE FUEL TANK

1. Close fuel tank air vent when transporting tank. This will prevent escape of fuel or vapors from tank.

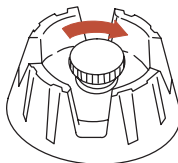

ob00325

TRANSPORTING

AUTO-VENTING TYPE FUEL TANK

1. Disconnect the remote fuel line from tank. This will close the air vent and prevent escape of fuel or vapors from tank.
2. Install tether cap over the fuel line connector stem. This will protect the connector stem from being accidentally pushed-in, thus, allowing fuel or vapor to escape.

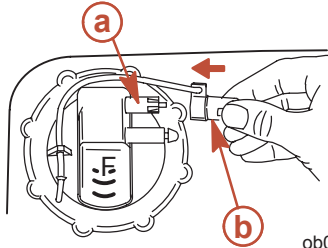

ob00326

a - Connector stem

b - Tether cap

FUEL & OIL

Gasoline Recommendations

UNITED STATES AND CANADA

Use a major brand of automotive unleaded gasoline with a minimum posted octane rating of 87. Mid-grade automotive gasolines that contain fuel injector cleaner are preferred for added internal engine cleanliness. Leaded gasoline is not recommended.

INTERNATIONAL

Use a major brand of automotive unleaded gasoline with a minimum posted octane rating of 90RON. Automotive gasolines that contain fuel injector cleaner are preferred for added internal engine cleanliness. Leaded gasoline is acceptable in areas where unleaded gasoline is not available.

USING REFORMULATED (OXYGENATED) FUELS - UNITED STATES ONLY

This type of fuel is required in certain areas of the United States. The two types of reformulated ingredients in these fuels are alcohol (Ethanol) or Ether (MTBE or ETBE). If Ethanol is the oxygenates that is used in the gasoline, refer to **Alcohol in Gasoline**.

These reformulated fuels are acceptable for use in the Mercury engine.

ALCOHOL IN GASOLINE

We do not recommend the use of gasoline which contains alcohol because of the possible adverse effect the alcohol may have on the fuel system. In general, if only gasoline containing alcohol is available, it must not contain more than 10% ethanol or 5% methanol, and the addition of a water separating fuel filter is recommended.

If gasoline containing alcohol is used or if you suspect the presence of alcohol in your gasoline, increase your inspection of the fuel system, visually checking for fuel leaks or abnormalities.

Gasoline containing alcohol may cause the following problems to your outboard and fuel system:

- Corrosion of metal parts
- Deterioration of elastomers and plastic parts
- Wear and damage of internal engine parts
- Starting and operating difficulties
- Vapor lock or fuel starvation

Some of these adverse effects are due to the tendency of gasoline containing alcohol to absorb moisture from the air, resulting in a phase of water and alcohol which separates from the gasoline in the fuel tank.

FUEL & OIL

The adverse effects of alcohol are more severe with methanol and are worse with increasing content of alcohol.

Filling Fuel Tank

WARNING

Avoid serious injury or death from a gasoline fire or explosion. Always stop the engine and do not smoke or allow open flames or sparks in the area while filling fuel tanks.

Fill fuel tanks outdoors away from heat, sparks, and open flames.

Remove portable fuel tanks from boat to refill them.

Always stop engine before refilling tanks.

Do not completely fill the fuel tanks. Leave approximately 10% of the tank volume unfilled. Fuel will expand in volume as its temperature rises and can leak under pressure if the tank is completely filled.

PORTABLE FUEL TANK PLACEMENT IN THE BOAT

Place the fuel tank in the boat so the vent is higher than the fuel level under normal boat operating conditions.

FUEL & OIL

Engine Oil Recommendations

We recommend the use of Mercury or Quicksilver SAE 10W-30 multi-viscosity 4-stroke outboard oil for general, all-temperature use. If SAE 25W-40 multi-viscosity oil is preferred, use Mercury MerCruiser 4-cycle engine oil or Quicksilver sterndrive & inboard 4-cycle engine oil. Never use 4-cycle engine oil that is not certified to meet or exceed any one or combination of the following American Petroleum Institute (API) Service Classification SH, SG, SF, CF-4, CE, CD, CDII. Severe engine damage may result from use of an inferior oil.

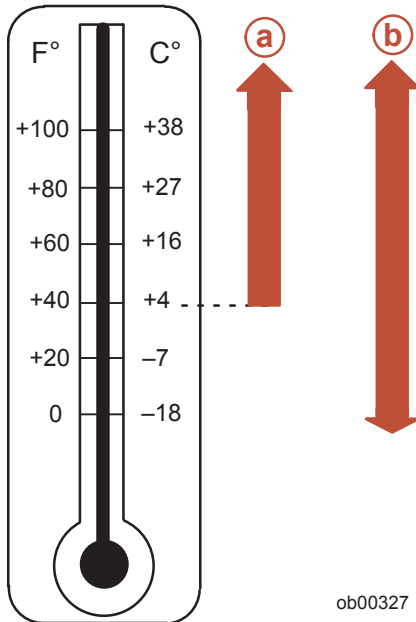

Recommended SAE Viscosity for Engine Oil

- a** - SAE 25W-40 viscosity oil may be used at temperatures above 4 °C (40 °F)
- b** - SAE 10W-30 viscosity oil is recommended for use in all temperatures.

Checking And Adding Engine Oil

IMPORTANT: Do not overfill. Be sure that the outboard is upright (not tilted) when checking oil.

1. Turn the engine off. Have the outboard in a level operating position. Remove the top cowl.

FUEL & OIL

2. Flip the handle up and pull out the dipstick. Wipe it with a clean rag or towel and push it back in all the way.
3. Pull the dipstick back out again and observe the oil level. If the oil level is low, remove the oil filler cap and fill to (but not over) the upper oil level with the recommended oil.

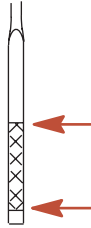

ob01456

IMPORTANT: Inspect oil for signs of contamination. Oil contaminated with water will have a milky color to it; oil contaminated with fuel will have a strong fuel smell. If contaminated oil is noticed, have the engine checked by your dealer.

4. Push the dipstick back in all the way, then flip the handle down to lock the dipstick in place. Reinstall the oil filler cap and hand tighten securely.

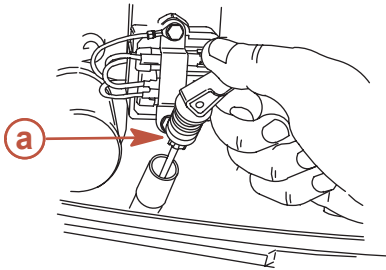

a - Dipstick

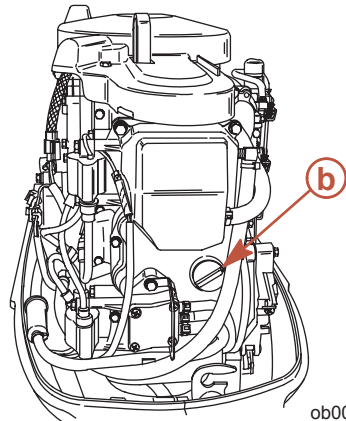

b - Oil filler cap

ob00648

FEATURES & CONTROLS

Remote Control Features

Your boat may be equipped with one of the Mercury Precision or Quicksilver remote controls shown. If not, consult your dealer for a description of the functions and operations of the remote control.

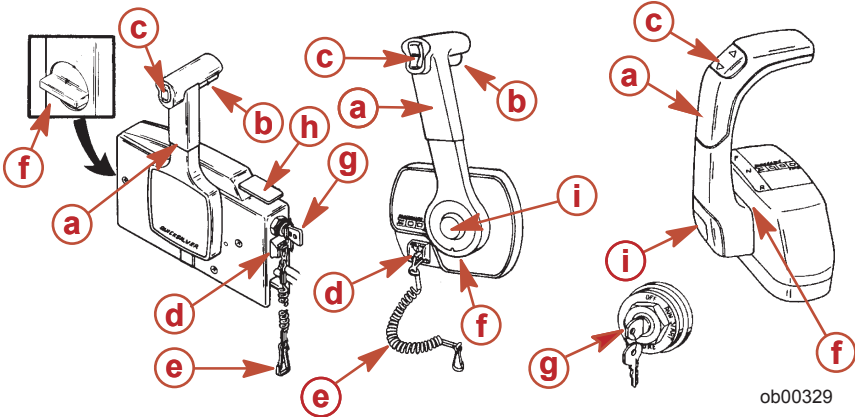

- a** - Control handle - forward, neutral, reverse.
- b** - Neutral release lever
- c** - Trim/tilt switch (if equipped). - Refer to **Features & Controls - Power Trim and Tilt**.
- d** - Lanyard stop switch - Refer to **General Information - Lanyard Stop Switch**.
- e** - Lanyard - Refer to **General Information - Lanyard Stop Switch**.
- f** - Throttle friction adjustment - Console controls require cover removal for adjustment.
- g** - Ignition key switch - off, on, start.
- h** - Fast idle lever - Refer to **Operation - Starting the Engine**.
- i** - Throttle only button - Refer to **Operation - Starting the Engine**.

FEATURES & CONTROLS

Warning System

The outboard warning system incorporates a warning horn inside the boat. Remote control models will have the warning horn located inside the remote control or connected to the ignition key switch. Tiller handle models will have the warning horn located in the ignition key panel.

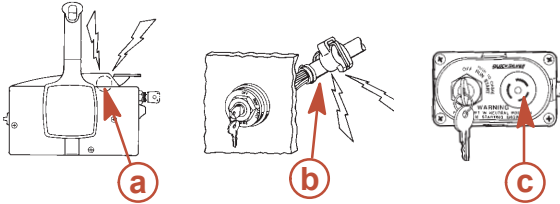

- a** - Horn inside remote control **c** - Horn in ignition key panel
b - Horn connected to ignition key switch

WARNING HORN SIGNALS

When the key switch is turned to the "on" position, the horn will turn on for a moment as a test to tell you the horn is working.

The warning horn will emit either a continuous beep or intermittent short beeps. This will alert the operator and help identify the following listed situations. For visual display of the specific engine functions and for additional engine data, refer to **SmartCraft Product** information, following.

Warning Horn		
Function	Sound	Description
Start Up	One Beep	Normal System Test
Engine Fault	Six Beeps at Start Up or While Driving	The horn sounds when there may be a problem with one of the engine functions. Have your dealer check the engine soon.

FEATURES & CONTROLS

Warning Horn		
Function	Sound	Description
Engine Fault	Three Beeps every 4 Minutes	Engine problem has occurred. Engine will run rough and/or stall. Engine may not start. Advancing the remote control neutral fast idle feature or advancing the tiller handle throttle grip half way may assist starting. Have your dealer check the engine
Engine Fault	Intermittent Beep	Engine problem has occurred. Engine will not run. Have your dealer check the engine
Cooling System Problem	Continuous	Engine Guardian System is activated. Power limit will vary with level of overheat. Shift outboard into neutral and check for a steady stream of water coming out of the water pump indicator hole. If no water is coming out of the water pump indicator hole or flow is intermittent, stop engine and check water intake holes for obstruction.

FEATURES & CONTROLS

Warning Horn		
Function	Sound	Description
Low Oil Pressure	Continuous	Engine Guardian System is activated. Power will be limited to 2000 RPM. First, stop the engine and check the oil level. Add oil if necessary.
Engine Overspeed	Continuous	The warning horn is activated any time engine speed exceeds the maximum allowable RPM. The system will limit the engine speed to within the allowable range. Engine overspeed indicates a condition that should be corrected. Overspeed could be caused by incorrect propeller pitch, engine height, trim angle, etc.
Battery Voltage to High or to Low	Continuous	Engine Guardian System is activated. Power limit will restrict engine speed to 75%.
Coolant Sensor Failure	Continuous	Engine Guardian System is activated. Power limit will restrict engine speed to 50%.

ENGINE GUARDIAN SYSTEM

The Engine Guardian System monitors the critical sensors on the engine for any early indications of problems. The system will respond to a problem by emitting a continuous beep and/or reducing engine power in order to provide engine protection.

FEATURES & CONTROLS

If Guardian System has been activated, reduce throttle speed. The horn will turn off when throttle speed is within the allowable limit. Consult your dealer for assistance.

SMARTCRAFT PRODUCT

A Mercury SmartCraft System instrument package can be purchased for this outboard. A few of the functions the instrument package will display are engine RPM, coolant temperature, battery voltage, fuel consumption and engine operating hours.

The SmartCraft Instrument package will also aid in Engine Guardian diagnostics. The SmartCraft Instrument package will display critical engine alarm data and potential problems.

Power Trim and Tilt (If Equipped)

Your outboard has a trim/tilt control called power trim. This enables the operator to easily adjust the position of the outboard by pressing the trim switch. Moving the outboard in closer to the boat transom is called trimming in or down. Moving the outboard further away from the boat transom is called trimming out or up. The term trim generally refers to the adjustment of the outboard within the first 20° range of travel. This is the range used while operating your boat on plane. The term tilt is generally used when referring to adjusting the outboard further up out of the water. With the engine turned off, the outboard can be tilted out of the water. At low idle speed, the outboard can also be tilted up past the trim range to permit, for example, shallow water operation.

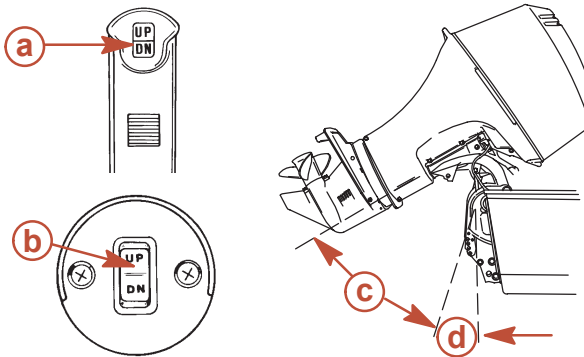

a - Remote control trim switch

b - Panel mount trim switch

c - Tilt range of travel

d - Trim range of travel

FEATURES & CONTROLS

POWER TRIM OPERATION

With most boats, operating around the middle of the trim range will give satisfactory results. However, to take full advantage of the trimming capability there may be times when you choose to trim your outboard all the way in or out. Along with an improvement in some performance aspects comes a greater responsibility for the operator, and this is being aware of some potential control hazards.

The most significant control hazard is a pull or torque that can be felt on the steering wheel or tiller handle. This steering torque results from the outboard being trimmed so that the propeller shaft is not parallel to the water surface.

WARNING

Avoid possible serious injury or death. When the outboard is trimmed in or out beyond a neutral steering condition, a pull on the steering wheel or tiller handle in either direction may result. Failure to keep a continuous firm grip on the steering wheel or tiller handle when this condition exists can result in loss of boat control as the outboard can turn freely. The boat can now spin out or go into a very tight maximum turn which, if unexpected, can result in occupants being thrown within the boat or out of the boat.

Consider the following lists carefully.

Trimming In or Down Can:

- Lower the bow.
- Result in quicker planing off, especially with a heavy load or a stern heavy boat.
- Generally improve the ride in choppy water.
- Increase steering torque or pull to the right (with the normal right hand rotation propeller).

FEATURES & CONTROLS

- In excess can lower the bow of some boats to a point where they begin to plow with their bow in the water while on plane. This can result in an unexpected turn in either direction (called bow steering or over-steering) if any turn is attempted, or if a significant wave is encountered.

WARNING

Avoid possible serious injury or death. Adjust outboard to an intermediate trim position as soon as boat is on plane to avoid possible ejection due to boat spin out. Do not attempt to turn boat when on plane if outboard is trimmed extremely in or down and there is a pull on the steering wheel or tiller handle.

- In rare circumstances, the owner may decide to limit the trim in. This can be accomplished by repositioning the tilt stop pins into whatever adjustment holes in the transom brackets are desired.

Trimming Out or Up can:

- Lift the bow higher out of the water.
- Generally increase top speed.
- Increase clearance over submerged objects or a shallow bottom.
- Increase steering torque or pull to the left at a normal installation height (with the normal right hand rotation propeller).
- In excess can cause boat porpoising (bouncing) or propeller ventilation.
- Cause engine overheating if any cooling water intake holes are above the water line.

TILTING OPERATION

To tilt outboard, shut off the engine and press the trim/tilt switch or auxiliary tilt switch to the up position. The outboard will tilt up until the switch is released or it reaches its maximum tilt position.

1. Engage the tilt support lever, by rotating knob to bring the support lever upward.
2. Lower outboard to rest on the tilt support lever.

FEATURES & CONTROLS

3. Disengage the tilt support lever, by raising the outboard off the support lever and rotating the lever down. Lower the outboard.

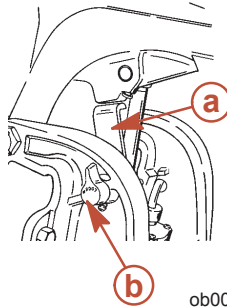

ob00336

a - Tilt support lever

b - Knob

MANUAL TILTING

If the outboard cannot be tilted using the power trim/tilt switch, the outboard can be manually tilted.

1. Turn out the manual tilt release valve 3 turns counterclockwise. This allows manual tilting of the outboard. Tilt the outboard to the desired position and tighten the manual tilt release valve.

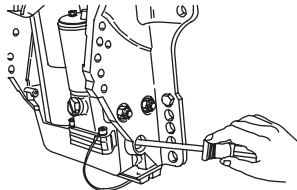

ob00339

NOTE: *The manual tilt release valve must be tightened before operating the outboard to prevent the outboard from tilting up during reverse operation.*

FEATURES & CONTROLS

AUXILIARY TILT SWITCH

The auxiliary tilt switch can be used to tilt the outboard up or down using the power trim system.

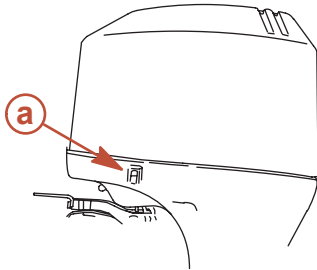

ob00340

a - Auxiliary tilt switch

SHALLOW WATER OPERATION

When operating the boat in shallow water, the outboard can be tilted beyond the maximum trim range to prevent hitting bottom.

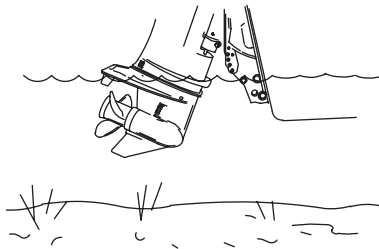

ob00334

1. Reduce engine speed below 2000 RPM.
2. Tilt outboard up. Make sure all the water intake holes stay submerged at all times.
3. Operate the engine at slow speed only. If engine speed exceeds 2000 RPM, the outboard will automatically return down to the maximum trim range.

FEATURES & CONTROLS

Throttle Grip Friction Adjustment - Tiller Handle Models

Throttle Grip Friction Knob - Turn friction knob to set and maintain the throttle at desired speed. Turn knob clockwise to tighten friction and turn knob counterclockwise to loosen friction.

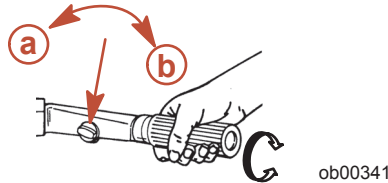

a - Loosen friction

b - Tighten friction

Steering Friction Adjustment

TILLER HANDLE MODELS

Steering Friction Adjustment - Adjust this lever to achieve the desired steering friction (drag) on the tiller handle. Move lever to the left to tighten friction or move to the right to loosen friction.

NOTE: To maintain proper adjustment, the locknut located on top of the steering friction lever pivot shaft can be tightened.

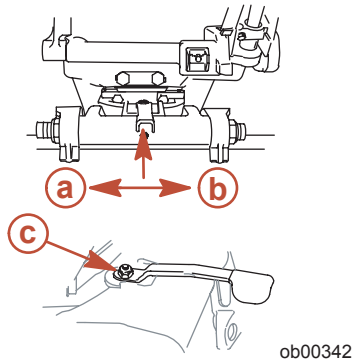

a - Tighten friction

c - Locknut

b - Loosen friction

FEATURES & CONTROLS

REMOTE STEERING MODELS

WARNING

Avoid possible serious injury or death from loss of boat control. Maintain sufficient steering friction to prevent the outboard from steering into a full turn if the tiller handle is released.

Steering Friction Adjustment - Adjust this screw to achieve the desired steering friction (drag) on the steering wheel. Turn screw clockwise to tighten friction or turn counterclockwise to loosen friction.

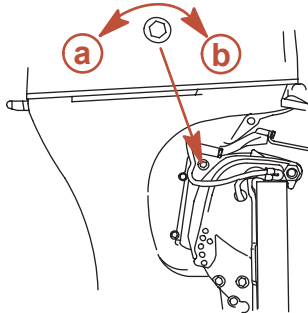

ob00343

a - Loosen friction

b - Tighten friction

Trim Tab Adjustment

Propeller steering torque will cause your boat to pull in one direction. This steering torque is a normal thing that results from your outboard not being trimmed so the propeller shaft is parallel to the water surface. The trim tab can help to compensate for this steering torque in many cases and can be adjusted within limits to reduce any unequal steering effort.

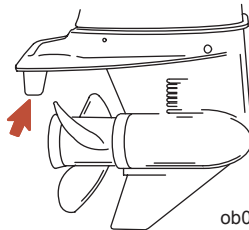

ob00344

NOTE: Trim tab adjustment will have little effect reducing steering torque if the outboard is installed with the anti-ventilation plate approximately 50 mm (2 in.) or more above the boat bottom.

FEATURES & CONTROLS

MODELS WITHOUT POWER TRIM

Operate your boat at normal cruising speed trimmed to desired position by installing the tilt pin in the desired tilt pin hole. Turn your boat left and right and note the direction the boat turns more easily.

If adjustment is necessary, loosen trim tab bolt and make small adjustments at a time. If the boat turns more easily to the left, move the trailing edge of trim tab to the left. If the boat turns more easily to the right move the trailing edge of trim tab to the right. Retighten bolt and retest.

MODELS WITH POWER TRIM

Operate your boat at normal cruising speed, trimmed to desired position. Turn your boat left and right and note the direction the boat turns more easily.

If adjustment is necessary, loosen trim tab bolt and make small adjustments at a time. If the boat turns more easily to the left, move the trailing edge of trim tab to the left. If the boat turns more easily to the right move the trailing edge of trim tab to the right. Retighten bolt and retest.

OPERATION

Pre-Starting Check List

- Operator knows safe navigation, boating, and operating procedures.
- An approved personal flotation device of suitable size for each person aboard and readily accessible (it is the law).
- A ring type life buoy or buoyant cushion designed to be thrown to a person in the water.
- Know your boats maximum load capacity. Look at the boat capacity plate.
- Fuel supply OK.
- Arrange passengers and load in the boat so the weight is distributed evenly and everyone is seated in a proper seat.
- Tell someone where you are going and when you expect to return.
- It is illegal to operate a boat while under the influence of alcohol or drugs.
- Know the waters and area you will be boating; tides, currents, sand bars, rocks, and other hazards.
- Make inspection checks listed in **Maintenance - Inspection and Maintenance Schedule**.

Operating In Freezing Temperatures

When using your outboard or having your outboard moored in freezing or near freezing temperatures, keep the outboard tilted down at all times so the gearcase is submerged. This prevents trapped water in gearcase from freezing and causing possible damage to the water pump and other components.

If there is a chance of ice forming on the water, the outboard should be removed and drained completely of water. If ice should form at the water level inside the outboard driveshaft housing, it will block water flow to the engine causing possible damage.

Operating In Salt Water Or Polluted Water

We recommend that you flush the internal water passages of your outboard with fresh water after each use in salt or polluted water. This will prevent a buildup of deposits from clogging the water passages. Refer to **Maintenance - Flushing The Cooling System**.

If you keep your boat moored in the water, always tilt the outboard so the gearcase is completely out of water (except in freezing temperatures) when not in use.

OPERATION

Wash down the outboard exterior and flush out the exhaust outlet of the propeller and gearcase with fresh water after each use. Each month, spray Mercury Precision or Quicksilver Corrosion Guard on external metal surfaces. Do not spray on corrosion control anodes as this will reduce the effectiveness of the anodes.

Pre-Starting Instructions

1. Connect the remote fuel line to the outboard. Make sure connector is snapped into place.

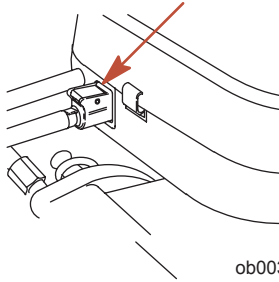

ob00345

2. Check the engine oil level.

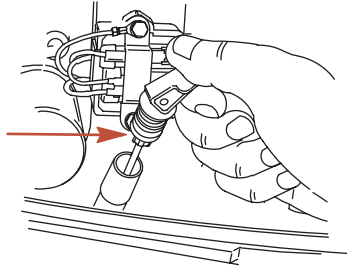

ob00346

OPERATION

3. Make sure the cooling water intake is submerged.

⚠ CAUTION

Never start or operate your outboard (even momentarily) without water circulating through all the cooling water intake holes in the gearcase to prevent damage to the water pump (running dry) or overheating of the engine.

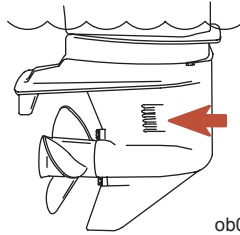

ob00347

Engine Break-in Procedure

⚠ CAUTION

Severe damage to the engine can result by not complying with the Engine Break-in Procedure.

1. For the first hour of operation, run the engine at varied throttle settings up to 3500 RPM or at approximately half throttle.
2. For the second hour of operation, run the engine at varied throttle settings up to 4500 RPM or at three-quarter throttle, and during this period of time, run it at full throttle for approximately one minute every ten minutes.
3. For the next eight hours of operation, avoid continuous operation at full throttle for more than five minutes at a time.

Starting The Engine - Remote Control Models

Before starting, read the Pre-Starting Check List, Special Operating Instructions, and Engine Break-in Procedure in the Operation section.

NOTE: *EFI models - Engine must have a fully charged battery to start the engine.*

OPERATION

⚠ CAUTION

Never start or operate your outboard (even momentarily) without water circulating through all the cooling water intake holes in the gearcase to prevent damage to the water pump (running dry) or overheating of the engine.

1. Open fuel tank vent screw (in filler cap) on manual venting type fuel tanks.

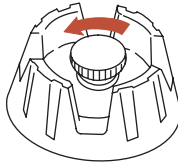

ob00348

2. Squeeze the fuel line primer bulb several times until it feels firm.

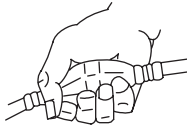

ob00349

3. Set the lanyard stop switch to RUN position. Refer to **General Information - Lanyard Stop Switch**.



ob00350

4. Shift outboard to neutral (N) position.

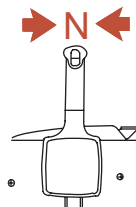

ob00351

OPERATION

5. Move the neutral fast idle speed feature to the fully closed position.

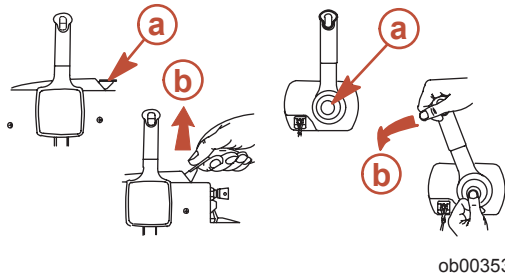

a - Fully closed position

b - Maximum fast idle speed position

6. Starting Flooded Engine - Advance the neutral fast idle speed feature to the maximum fast idle speed position and continue to crank the engine for starting. Immediately reduce engine speed after engine starts.
7. Turn ignition key to the "start" position. If engine fails to start in ten seconds, return key to "on" position, wait 30 seconds and try again.

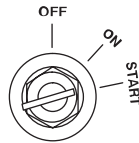

ob00354

8. After engine starts, check for a steady stream of water flowing out of the water pump indicator hole.

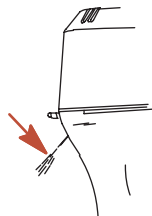

ob00331

IMPORTANT: If no water is coming out of the water pump indicator hole, stop engine and check cooling water intake for obstruction. No obstruction may indicate a water pump failure or blockage in the cooling system. These conditions will cause the engine to overheat. Have the outboard checked by your dealer. Operating the engine while overheated will cause engine damage.

OPERATION

WARMING UP ENGINE

Before beginning operation, allow the engine to warm up at idling speed for 3 minutes.

Starting The Engine - Tiller Handle Models

Before starting, read the Pre-Starting Check List, Special Operating Instructions, and Engine Break-in Procedure in the Operation section.

NOTE: *EFI models - Engine must have a fully charged battery to start the engine.*

CAUTION

Never start or operate your outboard (even momentarily) without water circulating through all the cooling water intake holes in the gearcase to prevent damage to the water pump (running dry) or overheating of the engine.

1. Open fuel tank vent screw (in filler cap) on manual venting type fuel tanks.

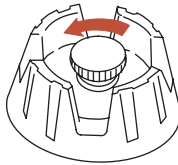

ob00348

2. Squeeze the fuel line primer bulb several times until it feels firm.

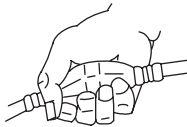

ob00349

3. Set the lanyard stop switch to RUN position. Refer to **General Information - Lanyard Stop Switch**.



ob00350

OPERATION

- Shift outboard to neutral (N) position.

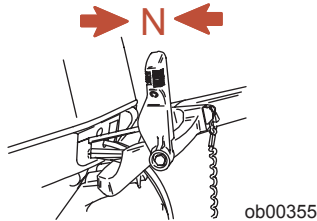

- Set the throttle grip to start position.

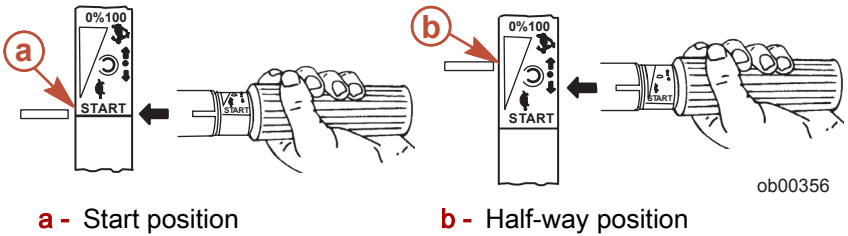

- Starting Flooded Engine - Set the throttle grip to half-way position.
- Turn ignition key to the "start" position. If engine fails to start in ten seconds, return key to "on" position, wait 30 seconds and try again.

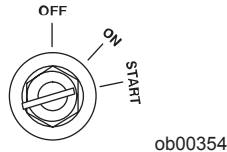

⚠ WARNING

RAPID ACCELERATION HAZARD - Before shifting your outboard from neutral into gear, decrease engine speed to slow. This will prevent a rapid acceleration that can cause people in the boat to be thrown from their seats or out of the boat, causing injury or death.

OPERATION

8. Check for a steady stream of water flowing out of the water pump indicator hole.

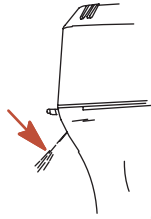

ob00331

IMPORTANT: If no water is coming out of the water pump indicator hole, stop engine and check cooling water intake for obstruction. No obstruction may indicate a water pump failure or blockage in the cooling system. These conditions will cause the engine to overheat. Have the outboard checked by your dealer. Operating the engine while overheated may cause serious engine damage.

WARMING UP ENGINE

Before beginning operation, allow the engine to warm up at idling speed for 3 minutes.

Gear Shifting

IMPORTANT: Observe the following:

- Never shift outboard into gear unless engine speed is at idle.
- Do not shift outboard into reverse when the engine is not running.
- Your outboard has three gear shift positions to provide operation: Forward (F), Neutral (out of gear), and Reverse (R).

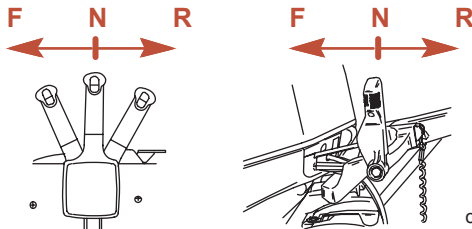

ob00358

OPERATION

- Remote Control Models - When shifting, always stop at neutral position and allow the engine speed to return to idle.

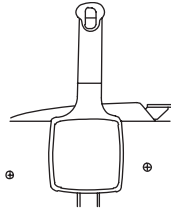

ob00308

- Tiller Handle Models - Reduce engine speed to idle before shifting.



ob00359

- Always shift outboard into gear with a quick motion.
- After shifting outboard into gear, advance the remote control lever or rotate the throttle grip (tiller handle) to increase speed.

Stopping The Engine

1. **Remote Control Models** - Reduce engine speed and shift outboard to neutral position. Turn ignition key to "OFF" position.

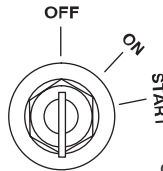

ob00360

2. **Tiller Handle Models** - Reduce engine speed and shift outboard to neutral position. Push in the engine stop button or turn ignition key to "OFF" position.

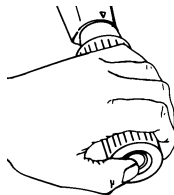

ob00361

Emergency Starting

If the starter system fails, use the spare starter rope (provided) and follow procedure.

OPERATION

NOTE: *EFI models - Engine must have a fully charged battery to start the engine.*

1. Remove flywheel cover or manual starter assembly.

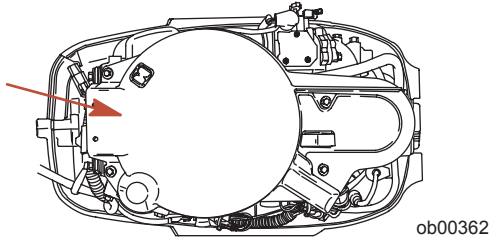

2. Shift outboard to neutral (N) position.

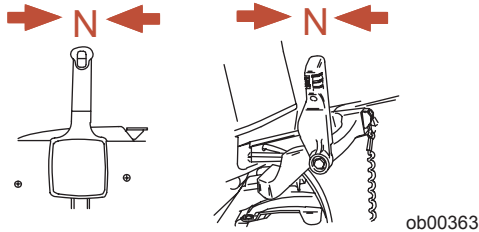

⚠ WARNING

When using emergency starter rope to start engine, the start in gear protection device is inoperative. Make sure to set the outboard gear shift into neutral to prevent outboard from starting in gear. Sudden unexpected acceleration could result in serious injury or death.

3. Electric Start Models - Turn the ignition key to "on" position.

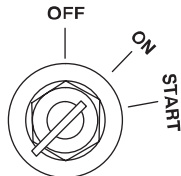

OPERATION

⚠ WARNING

To prevent getting an electrical shock, do not touch any ignition component, wiring, or spark plug wire when starting or running the engine.

⚠ WARNING

The exposed moving flywheel can cause serious injury. Keep your hands, hair, clothing, tools, and other objects away from engine when starting or running the engine. Do not attempt to reinstall the flywheel cover or top cowl when engine is running.

4. Place the starter rope knot into the flywheel notch and wind the rope clockwise around the flywheel.
5. Pull the starter rope to start the engine.

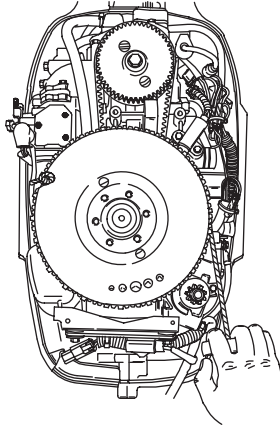

ob00365

MAINTENANCE

Outboard Care

To keep your outboard in the best operating condition, it is important that your outboard receive the periodic inspections and maintenance listed in the Inspection and Maintenance Schedule. We urge you to keep it maintained properly to ensure the safety of you and your passengers, and retain its dependability.

WARNING

Neglected inspection and maintenance service of your outboard or attempting to perform maintenance or repair on your outboard if you are not familiar with the correct service and safety procedures could cause personal injury, death, or product failure.

Record maintenance performed in Maintenance Log at the back of this book. Save all maintenance work orders and receipts.

SELECTING REPLACEMENT PARTS FOR YOUR OUTBOARD

We recommend using original Mercury Precision or Quicksilver replacement parts and Genuine Lubricants.

WARNING

Using a replacement part that is inferior to the original part could result in personal injury, death, or product failure.

EPA Emissions Regulations

All new outboards manufactured by Mercury Marine are certified to the United States Environmental Protection Agency, as conforming to the requirements of the regulations for the control of air pollution from new outboard motors. This certification is contingent on certain adjustments being set to factory standards. For this reason, the factory procedure for servicing the product must be strictly followed and, wherever practicable, returned to the original intent of the design. **Maintenance, replacement, or repair of the emission control devices and systems may be performed by any marine spark ignition (SI) engine repair establishment or individual.**

MAINTENANCE

EMISSION CERTIFICATION LABEL

An emission certification label, showing emission levels and engine specifications directly related to emissions, is placed on the engine at time of manufacture.

		EMISSION CONTROL INFORMATION	
THIS ENGINE CONFORMS TO <input type="text"/> CALIFORNIA AND U.S. EPA EMISSION REGULATIONS FOR SPARK IGNITION MARINE ENGINES			
REFER TO OWNERS MANUAL FOR REQUIRED MAINTENANCE SPECIFICATIONS AND ADJUSTMENTS			
a	IDLE SPEED (in gear): <input type="text"/>	FAMILY: <input type="text"/>	f
b	<input type="text"/> hp	<input type="text"/> cc	g
c	TIMING (IN DEGREES): <input type="text"/>		h
d	<input type="text"/>	SPARK PLUG: <input type="text"/>	i
		GAP: <input type="text"/>	
e	COLD VALVE CLEARANCE (mm): <input type="text"/>	INTAKE: <input type="text"/>	
		EXHAUST: <input type="text"/>	

ob00366

- | | |
|--|--|
| a - Idle speed | f - Family number |
| b - Engine horsepower | g - Maximum emission output for the engine family |
| c - Piston displacement | h - Timing specification |
| d - Date of manufacture | i - Recommended spark plug and gap |
| e - Valve clearance (if applicable) | |

OWNER RESPONSIBILITY

The owner/operator is required to have routine engine maintenance performed to maintain emission levels within prescribed certification standards.

The owner/operator is not to modify the engine in any manner that would alter the horsepower or allow emissions levels to exceed their predetermined factory specifications.

Inspection And Maintenance Schedule

BEFORE EACH USE

- Check engine oil level. See **Fuel & Oil - Checking and Adding Engine Oil**.
- Check that lanyard stop switch stops the engine.
- Visually inspect the fuel system for deterioration or leaks.
- Check outboard for tightness on transom.
- Check steering system for binding or loose components.

MAINTENANCE

- Visually check steering link rod fasteners for proper tightness. See **Steering Link Rod Fasteners**.
- Check propeller blades for damage.

AFTER EACH USE

- Flush out the outboard cooling system if operating in salt or polluted water. See **Flushing the Cooling System**.
- Wash off all salt deposits and flush out the exhaust outlet of the propeller and gearcase with fresh water if operating in salt water.

EVERY 100 HOURS OF USE OR ONCE YEARLY, WHICHEVER OCCURS FIRST

- Lubricate all lubrication points. Lubricate more frequently when used in salt water. See **Lubrication Points**.
- Change engine oil and replace the oil filter. The oil should be changed more often when the engine is operated under adverse conditions such as extended trolling. See **Changing Engine Oil**.
- Replace spark plugs at first 100 hours or first year. After that, inspect spark plugs every 100 hours or once yearly. Replace spark plugs as needed. See **Spark Plug Inspection and Replacement**.
- Inspect thermostat visually for corrosion and broken spring. Make sure thermostat closes completely at room temperature.¹
- Check engine fuel filter for contaminants. See **Fuel System**.
- Check engine timing setup.¹
- Check corrosion control anodes. Check more frequently when used in salt water. See **Corrosion Control Anodes**.
- Drain and replace gear case lubricant. See **Gearcase Lubrication**.
- Lubricate splines on the drive shaft.¹
- Check and adjust valve clearance, if necessary.¹
- Check power trim fluid. See **Checking Power Trim Fluid**.
- Inspect battery. See **Battery Inspection**.
- Check control cable adjustments.¹
- Inspect timing belt. See **Timing Belt Inspection**.
- Check tightness of bolts, nuts, and other fasteners.

EVERY 300 HOURS OF USE OR THREE YEARS

- Replace water pump impeller (more often if overheating occurs or reduced water pressure is noted).¹

¹. These items should be serviced by an authorized dealer.

MAINTENANCE

BEFORE PERIODS OF STORAGE

- Refer to Storage procedure. See **Storage** section.

Flushing The Cooling System

Flush the internal water passages of the outboard with fresh water after each use in salt, polluted, or muddy water. This will help prevent a buildup of deposits from clogging the internal water passages.

IMPORTANT: The engine must be run during flushing in order to open the thermostat and circulate water through the water passages.

WARNING

To avoid possible injury when flushing, remove the propeller. Refer to **Propeller Replacement**, following.

1. Place the outboard in either the operating position (vertical) or in a tilted position.
2. Remove propeller. Refer to **Propeller Replacement**.
3. Thread a water hose into the rear fitting. Partially open the water tap (1/2 maximum). Do not open the water tap all the way, as this allows a high pressure flow of water.

IMPORTANT: Do not run engine above idle when flushing.

4. Shift outboard into neutral. Start the engine and flush the cooling system for at least 5 minutes. Keep engine speed at idle.
5. Stop the engine. Turn off the water and remove hose. Reinstall the propeller.

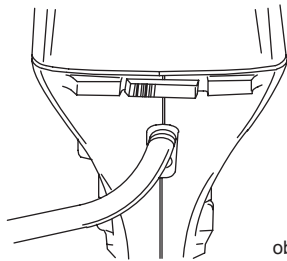

ob00367

MAINTENANCE

Top Cowl Removal And Installation

REMOVAL

1. Unlock the rear latch by pushing lever down.

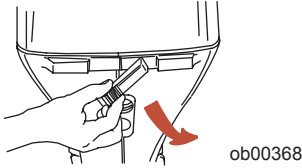

2. Lift rear of cowl and disengage front hook.

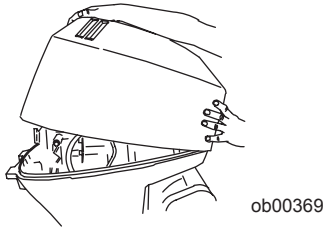

INSTALLATION

1. Engage the front hook and push cowl back over the cowl seal.
2. Push cowl down and move the rear latch lever up to lock.

Exterior Care

Your outboard is protected with a durable baked enamel finish. Clean and wax often using marine cleaners and waxes.

Battery Inspection

The battery should be inspected at periodic intervals to ensure proper engine starting capability.

IMPORTANT: Read the safety and maintenance instructions which accompany your battery.

1. Turn off the engine before servicing the battery.
2. Add water as necessary to keep the battery full.
3. Make sure the battery is secure against movement.
4. Battery cable terminals should be clean, tight, and correctly installed. Positive to positive and negative to negative.
5. Make sure the battery is equipped with a nonconductive shield to prevent accidental shorting of battery terminals.

MAINTENANCE

Fuel System

WARNING

Avoid serious injury or death from gasoline fire or explosion. Carefully follow all fuel system service instructions. Always stop the engine and do not smoke or allow open flames or sparks in the area while servicing any part of the fuel system.

Before servicing any part of the fuel system, stop engine and disconnect the battery. Drain the fuel system completely. Use an approved container to collect and store fuel. Wipe up any spillage immediately. Material used to contain spillage must be disposed of in an approved receptacle. Any fuel system service must be performed in a well ventilated area. Inspect any completed service work for sign of fuel leakage.

FUEL LINE INSPECTION

Visually inspect the fuel line and primer bulb for cracks, swelling, leaks, hardness, or other signs of deterioration or damage. If any of these conditions are found, the fuel line or primer bulb must be replaced.

ENGINE FUEL FILTER

Check the fuel filter for water accumulation or sediment. If water is in the fuel, remove the sight bowl and drain the water. If the filter appears to be contaminated, remove and replace.

REMOVAL

1. Read Fuel System servicing information and Warning proceeding.
2. Pull out the filter assembly from mount. Hold onto the cover to prevent it from turning and remove the sight bowl. Empty contents into an approved container.

MAINTENANCE

3. Pull out the filter element and replace it if necessary.

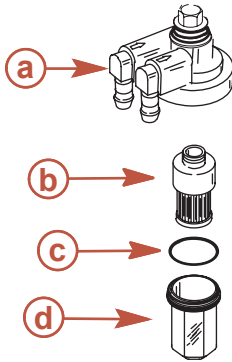

a - Cover

b - Filter element

c - O-ring seal

d - Sight bowl

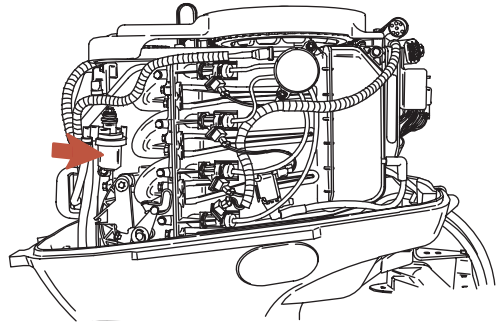

ob00649

INSTALLATION

IMPORTANT: Visually inspect for fuel leakage from the filter by squeezing the primer bulb until firm, forcing fuel into the filter.

1. Push the filter element into the cover.
2. Place the O-ring seal into its proper position on the sight bowl, and screw the sight bowl hand tight into the cover.
3. Push filter assembly back into mount.

Steering Link Rod Fasteners

IMPORTANT: The steering link rod that connects the steering cable to the engine must be fastened using special washer head bolt ("e" - Part Number 10-856680) and self-locking nylon insert locknuts ("b" & "d" - Part Number 11-826709113). These locknuts must never be replaced with common nuts (non-locking) as they will work loose and vibrate off, freeing the link rod to disengage.

MAINTENANCE

⚠ WARNING

Disengagement of a steering link rod can result in the boat taking a full, sudden, sharp turn. This potentially violent action can cause occupants to be thrown overboard exposing them to serious injury or death.

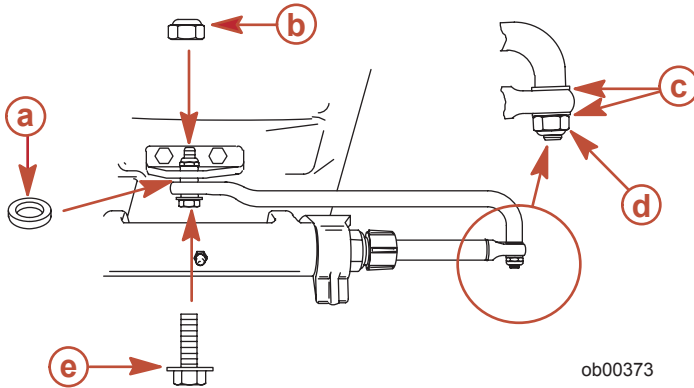

ob00373

- a** - Spacer (12-71970)
- b** - Nylon insert locknut (11-826709113)
- c** - Flat washer (2)
- d** - Nylon insert locknut (11-826709113)
- e** - Special washer head bolt (10-856680)

Description	Nm	lb. in.	lb. ft.
Nylon insert locknut "b"	27		20
Nylon insert locknut "d"	Tighten until seats then back off 1/4 turn		
Special washer head bolt	27		20

Assemble steering link rod to steering cable with two flat washers and nylon insert locknut. Tighten locknut until it seats, then back nut off 1/4 turn.

Assemble steering link rod to engine with special washer head bolt, locknut and spacer. First torque bolt, then locknut to specification.

MAINTENANCE

Corrosion Control Anode

Your outboard has corrosion control anodes at different locations. An anode helps protect the outboard against galvanic corrosion by sacrificing its metal to be slowly corroded instead of the outboard metals.

Each anode requires periodic inspection, especially in salt water which will accelerate the erosion. To maintain this corrosion protection, always replace the anode before it is completely eroded. Never paint or apply a protective coating on the anode as this will reduce effectiveness of the anode.

One anode is installed on the bottom of the transom bracket assembly. The trim tab is also an anode on the 87.3 mm (3 - 7/16 in.) diameter gearcase. The 108 mm (4 - 1/4 in.) diameter gearcase has three anodes. One of the anodes is the trim tab, and the other two anodes are located on each side of the gearcase.

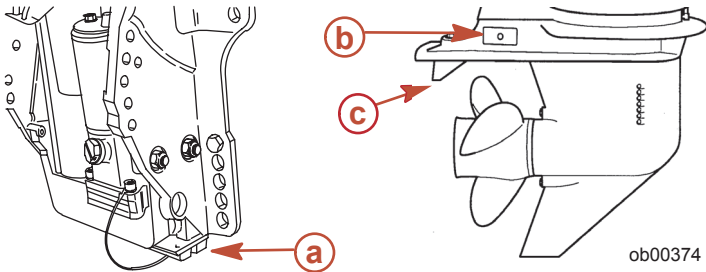

- a** - Anode on transom bracket assembly
- b** - Anode (2) on each side of gearcase
- c** - Trim tab

Propeller Replacement - 87.3 mm (3 - 7/16 in.) Diameter Gearcase

WARNING

If the propeller shaft is rotated while the engine is in gear, there is the possibility that the engine will crank over and start. To prevent this type of accidental engine starting and possible serious injury caused from being struck by a rotating propeller, always shift outboard to neutral position and remove spark plug leads when you are servicing the propeller.

MAINTENANCE

1. Shift outboard to neutral (N) position.

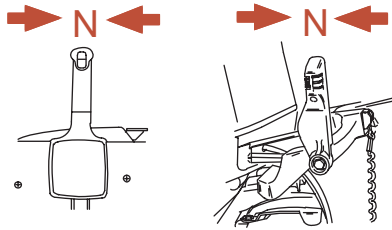

ob00363

2. Remove the spark plug leads to prevent engine from starting.

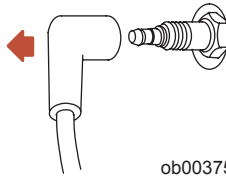

ob00375

3. Straighten the bent tabs on the propeller nut retainer.

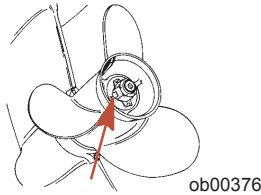

ob00376

4. Place a block of wood between gearcase and propeller to hold propeller and remove propeller nut.
5. Pull propeller straight off shaft. If propeller is seized to the shaft and cannot be removed, have the propeller removed by an authorized dealer.

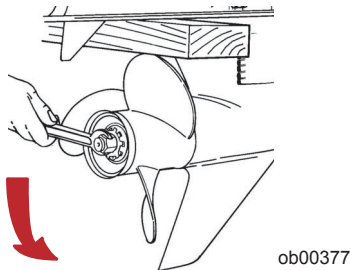

ob00377

MAINTENANCE

- Coat the propeller shaft with Quicksilver or Mercury Precision Lubricants Anti-Corrosion Grease or 2-4-C with Teflon.

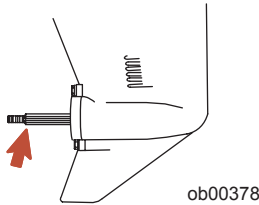

IMPORTANT: To prevent the propeller hub from corroding and seizing to the propeller shaft (especially in salt water), always apply a coat of the recommended lubricant to the entire propeller shaft at the recommended maintenance intervals, and also each time the propeller is removed.

- Flo-Torq I Drive Hub Propellers - Install forward thrust hub, propeller, propeller nut retainer and propeller nut onto the shaft.

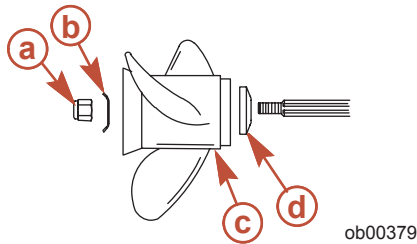

- | | |
|-----------------------------------|-------------------------------|
| a - Propeller nut | c - Propeller |
| b - Propeller nut retainer | d - Forward thrust hub |

- Flo-Torq II Drive Hub Propellers - Install forward thrust hub, propeller, replaceable drive sleeve, rear thrust hub, propeller nut retainer and propeller nut onto the shaft.

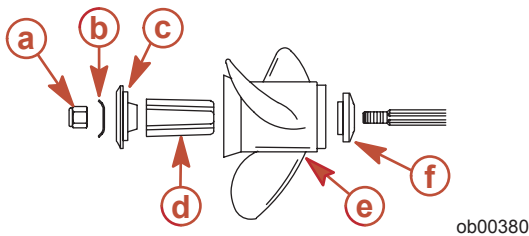

- | | |
|-----------------------------------|-------------------------------------|
| a - Propeller nut | d - Replaceable drive sleeve |
| b - Propeller nut retainer | e - Propeller |
| c - Rear thrust hub | f - Forward thrust hub |

MAINTENANCE

- Place propeller nut retainer over pins. Place a block of wood between gearcase and propeller and tighten propeller nut to specifications.

Description	Nm	lb. in.	lb. ft.
Propeller nut	75		55

- Align flat sides of the propeller nut with tabs on the propeller nut retainer. Secure propeller nut by bending tabs up and against the flats on the propeller nut.

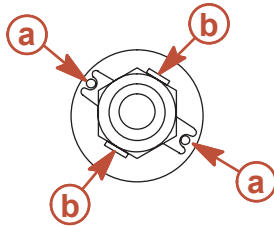

ob00381

a - Pins

b - Tabs

- Reinstall spark plug leads.

Propeller Replacement - 108 mm (4 - 1/4 in.) Diameter Gearcase

⚠ WARNING

If the propeller shaft is rotated while the engine is in gear, there is the possibility that the engine will crank over and start. To prevent this type of accidental engine starting and possible serious injury caused from being struck by a rotating propeller, always shift outboard to neutral position and remove spark plug leads when you are servicing the propeller.

- Shift outboard to neutral (N) position.

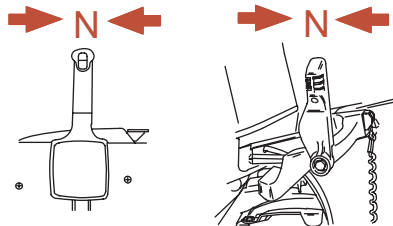

ob00363

MAINTENANCE

2. Remove spark plug leads to prevent engine from starting.

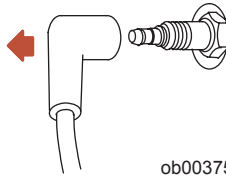

3. Straighten the bent tabs on the propeller nut retainer.

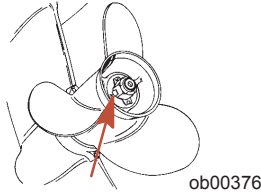

4. Place a block of wood between gearcase and propeller to hold propeller and remove propeller nut.
5. Pull propeller straight off shaft. If propeller is seized to the shaft and cannot be removed, have the propeller removed by an authorized dealer.

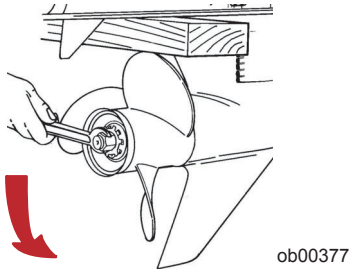

6. Coat the propeller shaft with Quicksilver or Mercury Precision Lubricants Anti-Corrosion Grease or 2-4-C with Teflon.

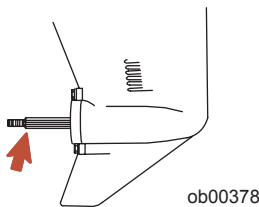

MAINTENANCE

IMPORTANT: To prevent the propeller hub from corroding and seizing to the propeller shaft (especially in salt water), always apply a coat of the recommended lubricant to the entire propeller shaft at the recommended maintenance intervals, and also each time the propeller is removed.

7. Flo-Torq I Drive Hub Propellers - Install thrust washer, propeller, continuity washer, thrust hub, propeller nut retainer, and propeller nut onto the shaft.

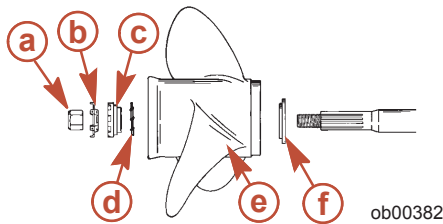

- | | |
|-----------------------------------|------------------------------|
| a - Propeller nut | d - Continuity washer |
| b - Propeller nut retainer | e - Propeller |
| c - Thrust hub | f - Thrust washer |

8. Flo-Torq II Drive Hub Propellers - Install forward thrust hub, replaceable drive sleeve, propeller, thrust hub, propeller nut retainer and propeller nut onto the shaft.

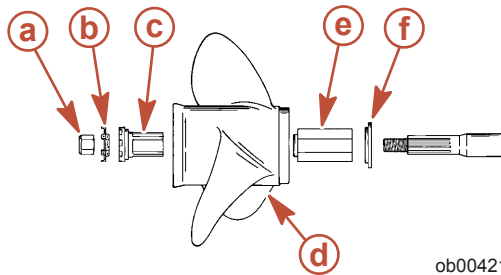

- | | |
|-----------------------------------|-------------------------------------|
| a - Propeller nut | d - Propeller |
| b - Propeller nut retainer | e - Replaceable drive sleeve |
| c - Thrust hub | f - Forward thrust hub |

NOTE: *Stainless Steel Applications - Installation of a Flo-Torq III drive hub propeller is recommended.*

MAINTENANCE

9. Flo-Torq III Drive Hub Propellers - Install forward thrust hub, replaceable drive sleeve, propeller, thrust hub, propeller nut retainer and propeller nut onto the shaft.

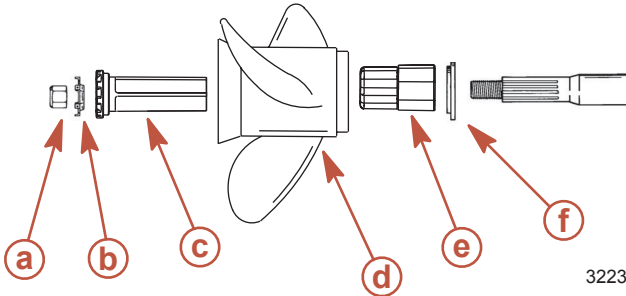

- a** - Propeller nut
b - Propeller nut retainer
c - Rear thrust hub
d - Propeller
e - Replaceable drive sleeve
f - Forward thrust hub

10. Place a block of wood between gearcase and propeller and torque propeller nut to specifications.

Description	Nm	lb. in.	lb. ft.
Propeller nut	75		55

11. Secure propeller nut by bending three of the tabs into the thrust hub grooves.

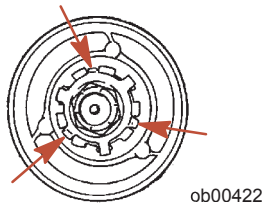

Spark Plug Inspection And Replacement

⚠ WARNING

Avoid serious injury or death from fire or explosion caused by damaged spark plug boots. Damaged spark plug boots can emit sparks. Sparks can ignite fuel vapors under the engine cowl. To avoid damaging spark plug boots, do not use any sharp object or metal tool such as pliers, screwdriver, etc. to remove spark plug boots.

MAINTENANCE

1. Remove the spark plug leads. Twist the rubber boots slightly and pull off.

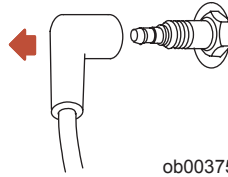

2. Remove the spark plugs to inspect. Replace spark plug if electrode is worn or the insulator is rough, cracked, broken, blistered or fouled.

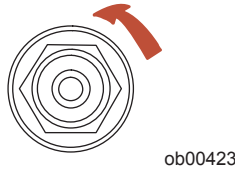

3. Set the spark plug gap to specification.

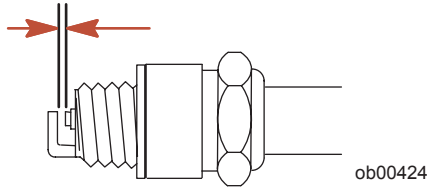

Spark Plug Gap
0.8 - 0.9 mm (0.031 - 0.035 in.)

4. Before installing spark plugs, clean off any dirt on the spark plug seats. Install plugs finger tight, and then tighten 1/4 turn or torque to specifications.

Description	Nm	lb. in.	lb. ft.
Spark plug	27		20

Fuse Replacement

IMPORTANT: Always carry spare 20 AMP fuses.

The electrical wiring circuits on the outboard are protected from overload by fuses in the wiring. If a fuse is blown, try to locate and correct the cause of the overload. If the cause is not found, the fuse may blow again.

MAINTENANCE

Open the fuse holder and look at the silver colored band inside the fuse. If band is broken, replace the fuse. Replace fuse with a new fuse with the same rating.

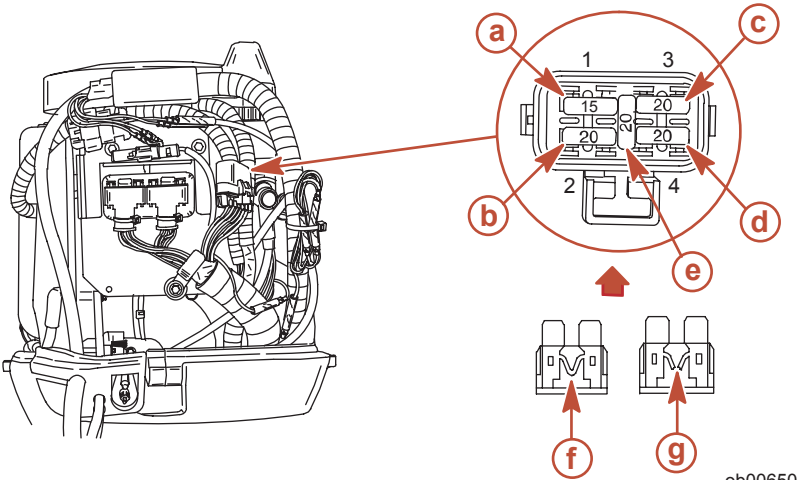

- a** - SmartCraft data bus circuit - 15 AMP fuse
- b** - Fuel pump/idle air control/fuel injector circuits - SFE 20 AMP fuse
- c** - Main relay/accessories - 20 AMP fuse
- d** - Ignition coil circuit - 20 AMP fuse
- e** - Spare 20 AMP fuse
- f** - Good fuse
- g** - Blown fuse

Timing Belt Inspection

1. Inspect the timing belt and have it replaced by an authorized dealer if any of the following conditions are found.
 - a. Cracks in the back of the belt or in the base of the belt teeth.
 - b. Excessive wear at the roots of the cogs.
 - c. Rubber portion swollen by oil.
 - d. Belt surfaces roughened.

MAINTENANCE

- e. Signs of wear on edges or outer surfaces of belt.

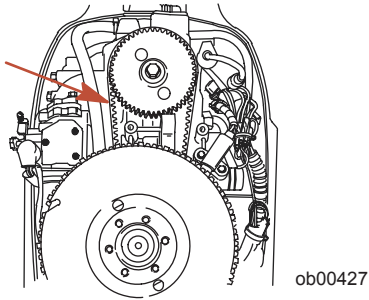

Lubrication Points

1. Lubricate the following with Quicksilver or Mercury Precision Lubricants Anti-Corrosion Grease or 2-4-C with Teflon.
 - Propeller Shaft - Refer to **Propeller Replacement** for removal and installation of the propeller. Coat the entire propeller shaft with lubricant to prevent the propeller hub from corroding and seizing to the shaft.

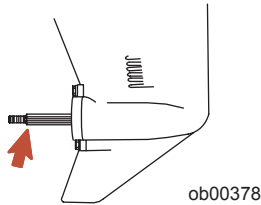

2. Lubricate the following with Quicksilver or Mercury Precision Lubricants 2-4-C with Teflon or Special Lubricant 101.
 - Tilt Support Lever - Lubricate through fitting.

MAINTENANCE

- Swivel Bracket - Lubricate through fitting.

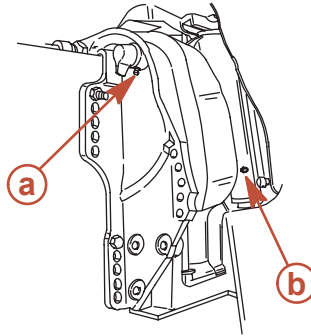

ob00429

a - Tilt support lever

b - Swivel bracket

- Tilt Tube - Lubricate through fitting.

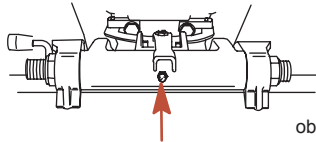

ob00428

⚠ WARNING

The end of the steering cable must be fully retracted into the outboard tilt tube before adding lubricant. Adding lubricant to steering cable when fully extended could cause steering cable to become hydraulically locked. A hydraulically locked steering cable will cause loss of steering control, possibly resulting in serious injury or death.

- Steering Cable Grease Fitting (If equipped) - Rotate steering wheel to fully retract the steering cable end into the outboard tilt tube. Lubricate through fitting.

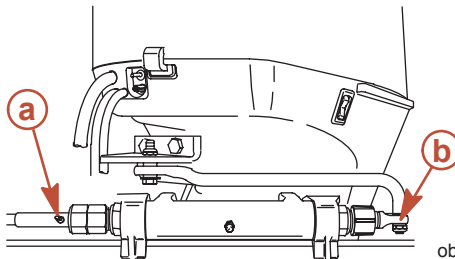

ob00432

a - Fitting

b - Steering cable end

MAINTENANCE

- Lubricate the following with light weight oil.
 - Steering Link Rod Pivot Points - Lubricate points.

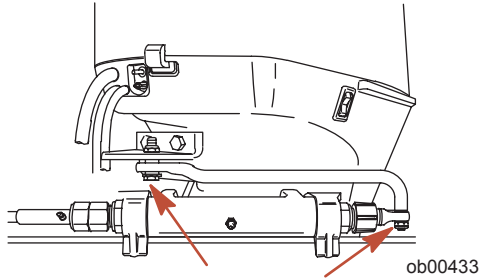

Checking Power Trim Fluid

- Tilt outboard to the full up position and engage the tilt support lock.

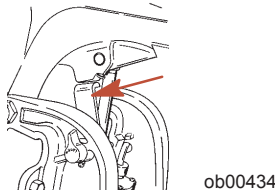

- Remove fill cap and check fluid level. The fluid level should be even with the bottom of the fill hole. Add Quicksilver or Mercury Precision Lubricants Power Trim & Steering Fluid. If not available, use automotive (ATF) automatic transmission fluid.

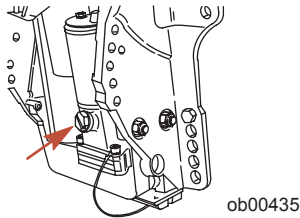

Changing Engine Oil

ENGINE OIL CAPACITY

3.0 Liter (3 U.S. Quarts).

OIL CHANGING PROCEDURE

- Tilt the outboard up to the trailer position.

MAINTENANCE

2. Turn the steering on the outboard so that the drain hole is facing downward. Remove drain plug and drain engine oil into an appropriate container. Lubricate the seal on the drain plug with oil and reinstall.

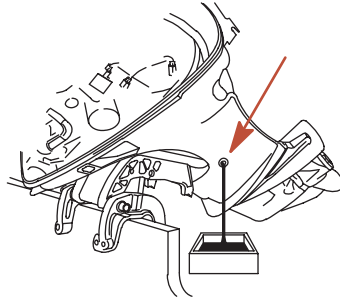

ob00436

CHANGING OIL FILTER

1. Place a rag or towel below the oil filter to absorb any spilled oil.
2. Unscrew old filter by turning the filter to the left.
3. Clean the mounting base. Apply film of clean oil to filter gasket. Do not use grease. Screw new filter on until gasket contacts base, then tighten $3/4$ to 1 turn.

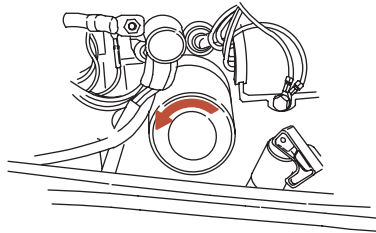

ob00437

OIL FILLING

1. Remove the oil fill cap and add oil to proper operating level.

MAINTENANCE

2. Idle engine for five minutes and check for leaks. Stop engine and check oil level on dipstick. Add oil if necessary.

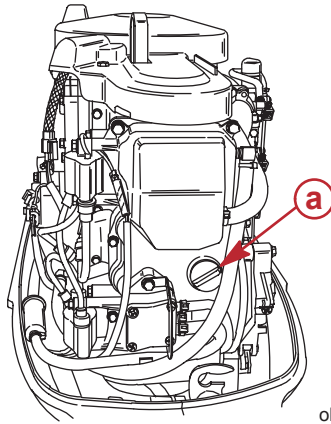

ob00651

a - Oil fill cap

Gearcase Lubrication - For 87.3 mm (3-7/16 in.) Diameter Gearcase

When adding or changing gearcase lubricant, visually check for the presence of water in the lubricant. If water is present, it may have settled to the bottom and will drain out prior to the lubricant, or it may be mixed with the lubricant, giving it a milky colored appearance. If water is noticed, have the gearcase checked by your dealer. Water in the lubricant may result in premature bearing failure or, in freezing temperatures, will turn to ice and damage the gearcase.

Examine the drained gearcase lubricant for metal particles. A small amount of fine metal particles indicates normal gear wear. An excessive amount of metal filings or larger particles (chips) may indicate abnormal gear wear and should be checked by an authorized dealer.

DRAINING GEARCASE

1. Place outboard in a vertical operating position.
2. Place a drain pan below outboard.

MAINTENANCE

3. Remove vent plug and fill/drain plug and drain lubricant.

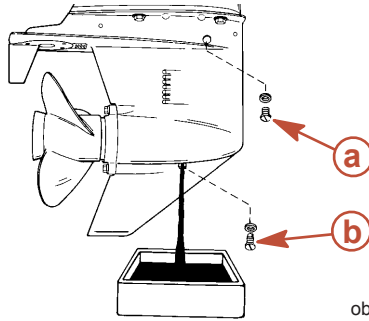

a - Vent plug

b - Fill/drain plug

GEARCASE LUBRICANT CAPACITY

Gearcase lubricant capacity is approximately 340 ml (11.5 fl. oz.).

CHECKING GEARCASE LUBRICANT LEVEL AND REFILLING GEARCASE

1. Place outboard in a vertical operating position.
2. Remove vent plug.
3. Place lubricant tube into the fill hole and add lubricant until it appears at the vent hole.

IMPORTANT: Replace sealing washers if damaged.

4. Stop adding lubricant. Install the vent plug and sealing washer before removing the lubricant tube.
5. Remove lubricant tube and reinstall cleaned fill/drain plug and sealing washer.

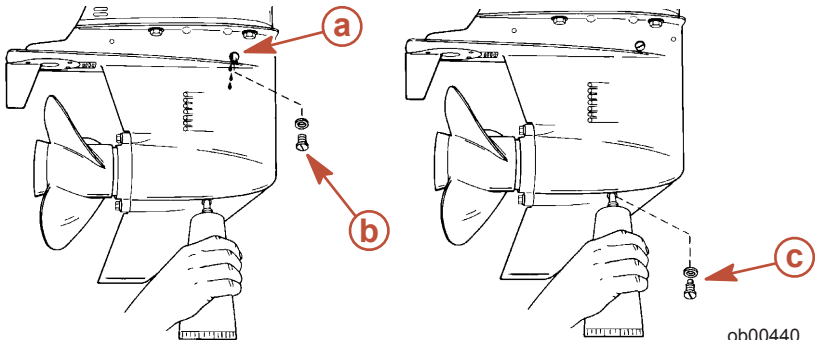

a - Vent hole

b - Vent plug

c - Fill/drain plug

MAINTENANCE

Gearcase Lubrication - For 108 mm (4 - 1/4 in.) Diameter Gearcase

When adding or changing gearcase lubricant, visually check for the presence of water in the lubricant. If water is present, it may have settled to the bottom and will drain out prior to the lubricant, or it may be mixed with the lubricant, giving it a milky colored appearance. If water is noticed, have the gearcase checked by your dealer. Water in the lubricant may result in premature bearing failure or, in freezing temperatures, will turn to ice and damage the gearcase.

Examine the drained gearcase lubricant for metal particles. A small amount of fine metal particles indicates normal gear wear. An excessive amount of metal filings or larger particles (chips) may indicate abnormal gear wear and should be checked by an authorized dealer.

DRAINING GEARCASE

1. Place outboard in a vertical operating position.
2. Place a drain pan below outboard.
3. Remove vent plugs and fill/drain plug and drain lubricant.

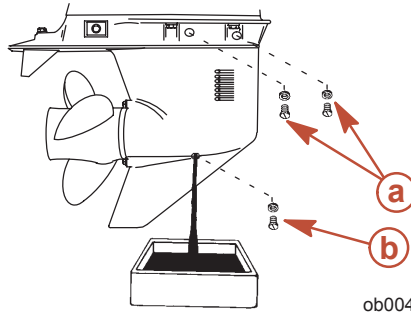

a - Vent plugs

b - Fill/drain plug

GEARCASE LUBRICANT CAPACITY

Gearcase lubricant capacity is approximately 710 ml (24 fl. oz.).

CHECKING LUBRICANT LEVEL AND FILLING GEARCASE

1. Place outboard in a vertical operating position.
2. Remove the front vent plug and rear vent plug.
3. Place lubricant tube into the fill hole and add lubricant until it appears at the front vent hole. At this time install the front vent plug and sealing washer.
4. Continue adding lubricant until it appears at the rear vent hole.

MAINTENANCE

5. Stop adding lubricant. Install the rear vent plug and sealing washer before removing lubricant tube.
6. Remove lubricant tube and reinstall cleaned fill/drain plug and sealing washer.

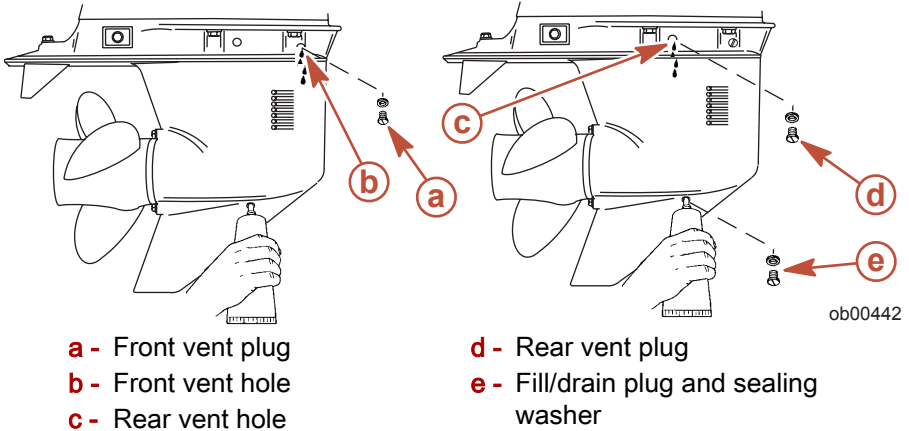

Submerged Outboard

A submerged outboard will require service within a few hours by an authorized dealer once the outboard is recovered from the water. This immediate attention by a servicing dealer is necessary once the engine is exposed to the atmosphere to minimize internal corrosion damage to the engine.

STORAGE

Storage Preparation

The major consideration in preparing your outboard for storage is to protect it from rust, corrosion, and damage caused by freezing of trapped water.

The following storage procedures should be followed to prepare your outboard for out of season storage or prolonged storage (two months or longer).

CAUTION

Never start or operate your outboard (even momentarily) without water circulating through all the cooling water intake holes in the gearcase to prevent damage to the water pump (running dry) or overheating of the engine.

FUEL SYSTEM

IMPORTANT: Gasoline containing alcohol (ethanol or methanol) can cause a formation of acid during storage and can damage the fuel system. If the gasoline being used contains alcohol, it is advisable to drain as much of the remaining gasoline as possible from the fuel tank, remote fuel line, and engine fuel system.

Fill the fuel tank and engine fuel system with treated (stabilized) fuel to help prevent formation of varnish and gum. Proceed with following instructions.

- **Portable Fuel Tank** - Pour the required amount of gasoline stabilizer (follow instructions on container) into fuel tank. Tip fuel tank back and forth to mix stabilizer with the fuel.
- **Permanently Installed Fuel Tank** - Pour the required amount of gasoline stabilizer (follow instructions on container) into a separate container and mix with approximately one quart (one liter) of gasoline. Pour this mixture into fuel tank.
- Remove the fuel filter sight bowl and empty contents in a suitable container. Refer to **Maintenance- Fuel System** for removal and installation of filter. Add 3 cc (1/2 tsp.) of gasoline stabilizer into the fuel filter sight bowl and reinstall.
- Place the outboard in water or connect flushing attachment for circulating cooling water. Run the engine for 15 minutes to fill the engine fuel system.

STORAGE

Protecting External Outboard Components

- Lubricate all outboard components listed in **Maintenance - Inspection and Maintenance Schedule**.
- Touch up any paint nicks. See your dealer for touch-up paint.
- Spray Quicksilver or Mercury Precision Lubricants Corrosion Guard on external metal surfaces (except corrosion control anodes).

Protecting Internal Engine Components

- Remove the spark plugs and inject a small amount of engine oil inside of each cylinder.
- Rotate the flywheel manually several times to distribute the oil in the cylinders. Reinstall spark plugs.
- Change the engine oil.

Gearcase

- Drain and refill the gearcase lubricant (refer to **Maintenance - Gearcase Lubrication**).

Positioning Outboard For Storage

Store outboard in an upright (vertical) position to allow water to drain out of outboard.

CAUTION

If outboard is stored tilted up in freezing temperature, trapped cooling water or rain water that may have entered the propeller exhaust outlet in the gearcase could freeze and cause damage to the outboard.

Battery Storage

- Follow the battery manufacturer's instructions for storage and recharging.
- Remove the battery from the boat and check water level. Recharge if necessary.
- Store the battery in a cool, dry place.
- Periodically check the water level and recharge the battery during storage.

TROUBLESHOOTING

Starter Motor Will Not Crank The Engine (Electric Start Models)

POSSIBLE CAUSES

- Blown 20 Amp fuse in the starting circuit. Refer to **Maintenance** section.
- Outboard is not shifted to neutral position.
- Weak battery or battery connections are loose or corroded.
- Ignition key switch failure.
- Wiring or electrical connection faulty.
- Starter motor or starter solenoid failure.

Engine Will Not Start

POSSIBLE CAUSES

- Lanyard stop switch not in "RUN" position.
- Incorrect starting procedure. Refer to **Operation** section.
- Old or contaminated gasoline.
- Engine flooded. Refer to **Operation** section.
- Fuel is not reaching the engine.
 - a. Fuel tank is empty.
 - b. Fuel tank vent not open or restricted.
 - c. Fuel line is disconnected or kinked.
 - d. Primer bulb not squeezed.
 - e. Primer bulb check valve is faulty.
 - f. Fuel filter is obstructed. Refer to **Maintenance** section.
 - g. Fuel pump failure.
 - h. Fuel tank filter obstructed.
- Blown 20 AMP fuse. Refer to **Maintenance** section.
- Ignition system component failure.
- Spark plugs fouled or defective. Refer to **Maintenance** section.

Engine Runs Erratically

POSSIBLE CAUSES

- Guardian System activated. Refer to **Features & Controls - Warning System**.
- Spark plugs fouled or defective. Refer to **Maintenance** section.

TROUBLESHOOTING

- Incorrect setup and adjustments.
- Fuel is being restricted to the engine.
 - a. Engine fuel filter is obstructed. Refer to **Maintenance** section.
 - b. Fuel tank filter obstructed.
 - c. Stuck anti-siphon valve located on permanently built-in type fuel tanks.
 - d. Fuel line is kinked or pinched.
- Fuel pump failure.
- Ignition system component failure.
- Fuel injection component failure (EFI Models).

Performance Loss

POSSIBLE CAUSES

- Engine Guardian System activated. Refer to **Features & Controls - Warning System**.
- Throttle not fully open.
- Damaged or improper size propeller.
- Incorrect engine timing, adjustments, or setup.
- Boat overloaded or load improperly distributed.
- Excessive water in bilge.
- Boat bottom is dirty or damaged.

Battery Will Not Hold Charge

POSSIBLE CAUSES

- Battery connections are loose or corroded.
- Low electrolyte level in battery.
- Worn out or inefficient battery.
- Excessive use of electrical accessories.
- Defective rectifier, alternator, or voltage regulator.

OWNER SERVICE ASSISTANCE

Local Repair Service

Always return your outboard to your local authorized dealer should the need for service arise. Only he has the factory trained mechanics, knowledge, special tools, equipment, and genuine parts and accessories to properly service your engine should the need occur. He knows your engine best.

Service Away From Home

If you are away from your local dealer and the need arises for service, contact the nearest authorized dealer. Refer to the Yellow Pages of the telephone directory. If, for any reason, you cannot obtain service, contact the nearest Mercury Marine Service Office.

Parts And Accessories Inquiries

All inquiries concerning genuine replacement parts and accessories should be directed to your local authorized dealer. The dealer has the necessary information to order parts and accessories for you. When inquiring on parts and accessories, the dealer requires the model and serial number to order the correct parts.

Service Assistance

Your satisfaction with your outboard product is very important to your dealer and to us. If you ever have a problem, question or concern about your outboard product, contact your dealer or any authorized Mercury Marine dealership. If additional assistance is required, take these steps.

1. Talk with the dealership's sales manager or service manager. If this has already been done, then contact the owner of the dealership.
2. Should you have a question, concern, or problem that cannot be resolved by your dealership, please contact Mercury Marine Service Office for assistance. Mercury Marine will work with you and your dealership to resolve all problems.

The following information will be needed by the service office:

- Your name and address
- Daytime telephone number
- Model and serial number of your outboard
- The name and address of your dealership
- Nature of problem

OWNER SERVICE ASSISTANCE

Mercury Marine Service Offices

For assistance, call, fax, or write. Please include your daytime telephone number with mail and fax correspondence.

United States		
Telephone	(920) 929-5040	Mercury Marine W6250 W. Pioneer Road P.O. Box 1939 Fond du Lac, WI 54936-1939
Fax	(920) 929-5893	
Website	www.mercurymarine.com	

Canada		
Telephone	(905) 567-6372	Mercury Marine Ltd. 2395 Meadowpine Blvd. Mississauga, Ontario L5N 7W6 Canada
Fax	(905) 567-8515	

Australia, Pacific		
Telephone	(61) (3) 9791-5822	Mercury Marine Australia 132-140 Frankston Road Dandenong, Victoria 3164 Australia
Fax	(61) (3) 9793-5880	

Europe, Middle East, Africa		
Telephone	(32) (87) 32 • 32 • 11	Marine Power - Europe, Inc. Parc Industriel de Petit-Rechain B-4800 Verviers, Belgium
Fax	(32) (87) 31 • 19 • 65	

Mexico, Central America, South America, Caribbean		
Telephone	(954) 744-3513	Mercury Marine 11650 Interchange Circle North Miramar, FL 33025 U.S.A.
Fax	(954) 744-3535	

OWNER SERVICE ASSISTANCE

Japan		
Telephone	81-53-423-2500	Mercury Marine - Japan 283-1 Anshin-cho Hamamatsu Shizuoka, 435-0005 Japan
Fax	81-53-423-2510	

Asia, Singapore		
Telephone	5466160	Mercury Marine Singapore 72 Loyang Way Singapore, 508762
Fax	5467789	

