



HEARTH PRODUCTS

P/N 875021M Rev. K 01/2011

This manual is part of a set of two supporting this product. Refer to P/N 850017M for Installation Instructions. Ce manuel est disponible en français, simplement en faire la demande. Numéro de la pièce 875021CF.

CARE AND OPERATION INSTRUCTIONS

EDV Direct-Vent Gas Fireplaces

ELITE™ SERIES

Table with 3 columns: MODELS, MILLIVOLT, ELECTRONIC. Lists model numbers like EDV3530CNM-B, EDV3530CPM-B, EDV3530CNE-B, etc.



OTL Report No. 116-F-05-5

WHAT'S INSIDE
Table of Contents ... 2
Safety and Your Fireplace ... 2
FREE Safety Guard Offer (Protects Against Burns) ... 2
Important Safety Information ... 4
Attaching the Safety-in-Operation Warnings ... 5
[EN FRANÇAIS] L'information de sûreté importante ... 3-4
Apposition des mises en garde relatives à la sécurité d'utilisation ... 5
[EN ESPAÑOL] Información importante de seguridad ... 3-4
Colocación de advertencias de seguridad en operación ... 5



INSTALLER: Leave this manual with the appliance.
CONSUMER: Retain this manual for future reference.
INSTALLATEUR : Laissez cette notice avec l'appareil.
CONSOMMATEUR : Conservez cette notice pour consultation ultérieure.



WARNING / AVERTISSEMENT / AVISO

- HOT GLASS WILL CAUSE BURNS.
DO NOT TOUCH GLASS UNTIL COOLED.
NEVER ALLOW CHILDREN TO TOUCH GLASS.



- UNE SURFACE VITRÉE CHAUDE PEUT CAUSER DES BRÛLURES.
LAISSER REFROIDIR LA SURFACE VITRÉE AVANT D'Y TOUCHER.
NE PERMETTEZ JAMAIS À UN ENFANT DE TOUCHER LA SURFACE VITRÉE.

- EL VIDRIO CALIENTE CAUSARÁ QUEMADURAS.
USTED DEBE NUNCA TOCAR EL VIDRIO CALIENTE.
LOS NIÑOS DEBEN NUNCA TOCAR EL VIDRIO.

WARNING: If the information in these instructions is not followed exactly, a fire or explosion may result, causing property damage, personal injury, or death.

- Do not store or use gasoline or other flammable vapors and liquids in the vicinity of this or any other appliance.
- WHAT TO DO IF YOU SMELL GAS:
• Do not try to light any appliance.
• Do not touch any electrical switch; do not use any phone in your building.
• Immediately call your gas supplier from a neighbor's phone. Follow the gas supplier's instructions.
• If you cannot reach your gas supplier, call the fire department.
- Installation and service must be performed by a qualified installer, service agency or the gas supplier.

AVERTISSEMENT : Assurez-vous de bien suivre les instructions données dans cette notice pour réduire au minimum le risque d'incendie ou d'explosion ou pour éviter tout dommage matériel, toute blessure ou la mort.

- Ne pas entreposer ni utiliser d'essence ni d'autres vapeurs ou liquides inflammables dans le voisinage de cet appareil ou de tout autre appareil.
- QUE FAIRE SI VOUS SENTEZ UNE ODEUR DE GAZ :
• Ne pas tenter d'allumer d'appareil.
• Ne touchez à aucun interrupteur. Ne pas vous servir des téléphones se trouvant dans le bâtiment où vous trouvez.
• Appelez immédiatement votre fournisseur de gaz depuis un voisin. Suivez les instructions du fournisseur.
• Si vous ne pouvez rejoindre le fournisseur de gaz, appelez le service des incendies.
- L'installation et l'entretien doivent être assurés par un installateur ou un service d'entretien qualifié ou par le fournisseur de gaz.

Thank you for your purchase. We appreciate your business!

Please carefully read and follow all instructions in this manual.
Pay special attention to all warnings and safety information.

Following these safety, care, and operation instructions will help ensure many years of dependable and enjoyable service from your fireplace.

• FREE SAFETY GUARD OFFER •

The Lennox® SAFETY GUARD protects against severe burns and injuries by preventing direct contact with the front glass surface of your fireplace.

To receive your FREE **SAFETY GUARD**, call **1-800-786-7976** or visit **www.lennox.com** (Lennox Hearth Products / Owner Resources)

Table of Contents

Safety and Your Fireplace 2
Important Safety Information 4
Attaching the Safety-in-Operation Warnings 5
 General Information 6
 Operation/Care of Your Appliance 8
 Gas Controls Access 8
 Variable Flame Adjustment. 9
 Maintenance. 10
 Front Glass Enclosure Panel, Removal and Installation 11
 Install Volcanic Stone, Embers and Logs 12
 Burner Flame Appearance/Sooting 15
 Burner Flame Adjustments. 16
 Millivolt Appliance Checkout 16
 Electronic Appliance Checkout 16
 Warranty 17
 Wiring Diagrams 17
 Replacement Parts 17
 Product Reference Information 17
 Accessory Components 18
 Maintenance Schedule 23
 Lighting Instructions – Millivolt 24
 Lighting Instructions – Electronic 26
 Troubleshooting Guide – Millivolt 28
 Troubleshooting Guide – Electronic 29
 Replacement Parts List 30



Safety and Your Fireplace

All parts of your Lennox Hearth Products fireplace get EXTREMELY HOT!

- To prevent severe burns and injuries, install a screen or physical barrier to prevent direct contact with the glass.

To order a FREE Lennox® SAFETY GUARD for your fireplace, see details at left.

- Follow the safety instructions below and be sure everyone in your household understands this burn hazard:

- **The surfaces on your fireplace get EXTREMELY HOT!**

- **The glass on the front of the fireplace reaches EXTREMELY HIGH temperatures and can cause severe burns if touched.**

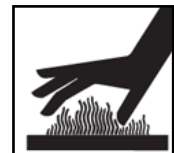

- **Keep children away from an operating fireplace. Closely supervise children in any room where a fireplace is operating to prevent contact with glass.**

- **Keep clothing, furniture, gasoline, and other flammable liquids away from the fireplace.**

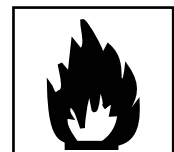

- **Even after the gas is turned off, fireplace surfaces remain extremely hot.**

- Be sure to attach the enclosed **Safety-in-Operation Warnings** where you turn on your fireplace, to help remind everyone of the dangers associated with high temperatures (see page 5).

- Read **Important Safety Information** on page 4.

[FRENCH]

La sécurité et votre foyer

**Toutes les parties de votre foyer
Lennox Hearth Products deviennent
EXTRÊMEMENT CHAUDES !**

- Afin d'éviter de vous brûler gravement ou de vous blesser, installez une grille ou une barrière physique pour empêcher tout contact direct avec la vitre.

***Pour commander un PANNEAU DE PROTECTION
Lennox® GRATUIT pour votre foyer, consultez
les détails dans la partie gauche.***

- Suivez les instructions de sécurité ci-dessous et veillez à ce que tous les membres de votre famille soient conscients du danger de brûlure encouru :
 - **Les surfaces de votre foyer deviennent EXTRÊMEMENT CHAUDES !**
 - **La vitre située à l'avant du foyer atteint des températures EXTRÊMEMENT ÉLEVÉES et peut causer de graves blessures en cas de contact.**
 - **Tenez les enfants à l'écart du foyer lorsqu'il fonctionne. Surveillez attentivement les enfants dans les pièces où un foyer est utilisé afin d'éviter qu'ils ne soient en contact avec la vitre.**
 - **Tenez tous les vêtements, les meubles, l'essence et tout autre liquide inflammable à l'écart du foyer.**
 - **Même après fermeture du gaz, les surfaces du foyer restent extrêmement chaudes.**
- Veillez à coller les **Étiquettes de mise en garde relatives à la sécurité d'utilisation** à l'endroit où vous utilisez le foyer, pour rappeler à tous les utilisateurs les dangers liés aux températures élevées (**voir page 5**).
- Lisez la section **Informations importantes relatives à la sécurité**, page 4.

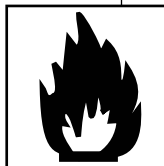

[SPANISH]

Seguridad y su chimenea

**¡Todas las partes de la chimenea
Lennox Hearth Products se ponen
MUY CALIENTES!**

- Instale una malla o barrera física para evitar el contacto directo con el vidrio y prevenir las quemaduras y lesiones graves.

***Ver los detalles a la izquierda para ordenar
un Lennox® SAFETY GUARD GRATIS
para su chimenea.***

- Siga las instrucciones de seguridad a continuación y asegúrese de que todos en su hogar sepan acerca de este peligro de quemadura:
 - **¡Las superficies de la chimenea se ponen MUY CALIENTES!**
 - **El vidrio delante de la chimenea alcanza temperaturas EXTREMADAMENTE ALTAS y puede causar quemaduras graves si se toca.**
 - **Mantenga a los niños alejados de la chimenea en funcionamiento. Supervise en forma cercana a los niños en cualquier cuarto donde haya una chimenea funcionando para impedir el contacto con el vidrio.**
 - **Mantenga la ropa, mobiliario, gasolina y otros líquidos inflamables alejados de la chimenea.**
 - **Aún después de haber apagado el gas, las superficies de la chimenea permanecen extremadamente calientes.**
- Asegúrese de colocar las **Etiquetas de advertencia de seguridad de operación** en el lugar donde enciende la chimenea, para que todos recuerden los peligros asociados con las altas temperaturas (**ver la página 5**).
- Lea la **Información importante** de seguridad en la **página 4**.

Important Safety Information

1. **WARNING:** Do not operate appliance with the glass front removed, cracked or broken. Replacement of the glass should be done by a licensed or qualified service person .
2. Do not use this appliance if any part has been under water. Immediately call a qualified service technician to inspect the appliance and to replace any part of the control system and any gas control which has been under water.
3. Due to high temperatures, the appliance should be located out of traffic and away from furniture and draperies.
4. Children and adults should be alerted to the hazards of high surface temperature and should stay away to avoid burns or clothing ignition.
5. Clothing or other flammable material should not be placed on or near the appliance.
6. Young children should be carefully supervised when they are in the same room as the appliance. Toddlers, young children, and others may be susceptible to accidental contact burns. A physical barrier is recommended if there are at-risk individuals in the house. To restrict access to a fireplace or stove, install an adjustable safety gate to keep toddlers, young children, and other at-risk individuals out of the room and away from hot surfaces.
7. Any safety screen or guard removed for servicing an appliance must be replaced prior to operating the appliance.
8. Installation and repair should be done by a qualified service person. The appliance should be inspected before use and at least annually by a professional service person. More frequent cleaning may be required due to excessive lint from carpeting, bedding material, et cetera. It is imperative that control compartments, burners, and circulating air passageways of the appliance be kept clean. See maintenance instructions on page 10.

L'information de sûreté importante

1. **AVERTISSEMENT.** Ne pas utiliser l'appareil si le panneau frontal en verre n'est pas en place, est craqué ou brisé. Confiez le remplacement du panneau à un technicien agréé
2. Ne pas utiliser cet appareil s'il a été plongé, même partiellement, dans l'eau. Appeler un technicien qualifié pour inspecter l'appareil et remplacer toute partie du système de commande et toute commande qui a été plongée dans l'eau.
3. En raison des températures élevées, l'appareil devrait être installé dans un endroit où il y a peu de circulation et loin du mobilier et des tentures.
4. Les enfants et les adultes devraient être informés des dangers que posent les températures de surface élevées et se tenir à distance afin d'éviter des brûlures ou que leurs vêtements ne s'enflamment.
5. On ne devrait pas placer de vêtements ni d'autres matières inflammables sur l'appareil ni à proximité.
6. Les jeunes enfants devraient être surveillés étroitement lorsqu'ils se trouvent dans la même pièce que l'appareil. Les tout petits, les jeunes enfants ou les adultes peuvent subir des brûlures s'ils viennent en contact avec la surface chaude. Il est recommandé d'installer une barrière physique si des personnes à risques habitent la maison. Pour empêcher l'accès à un foyer ou à un poêle, installez une barrière de sécurité ; cette mesure empêchera les tout petits, les jeunes enfants et toute autre personne à risque d'avoir accès à la pièce et aux surfaces chaudes.
7. Tout écran ou protecteur retiré pour permettre l'entretien de l'appareil doit être remis en place avant de mettre l'appareil en marche.
8. L'installation et la réparation devrait être confiées à un technicien qualifié. L'appareil devrait faire l'objet d'une inspection par un technicien professionnel avant d'être utilisé et au moins une fois l'an par la suite. Des nettoyages plus fréquents peuvent être nécessaires si les tapis, la literie, et cetera produisent une quantité importante de poussière. Il est essentiel que les compartiments abritant les commandes, les brûleurs et les conduits de circulation d'air de l'appareil soient tenus propres. Voyez les instructions d'entretien à la page 10.

[SPANISH]

Información importante de seguridad

1. **ADVERTENCIA:** No opere el artefacto con el frente de vidrio quitado, agrietado o roto. Un técnico de servicio licenciado o capacitado debe reemplazar el vidrio.
2. No use este artefacto si alguna de sus partes ha estado bajo agua. Llame de inmediato a un técnico de servicio calificado para que inspeccione el artefacto y reemplace cualquier parte del sistema de control y cualquier control de gas que haya estado bajo agua.
3. Debido a las altas temperaturas, el artefacto debe situarse fuera de las áreas de tráfico y lejos del mobiliario y cortinas.
4. Se debe alertar a los niños y adultos sobre los peligros de las altas temperaturas en la superficie y que se mantengan alejados para evitar quemaduras o ignición de la ropa.
5. No debe colocarse ropa u otros materiales inflamables sobre y cerca del artefacto.

6. Se debe supervisar de cerca a los niños cuando estén en el mismo cuarto que el artefacto. Los niños pequeños, los jóvenes y otras personas pueden ser susceptibles a quemaduras por contacto accidental. Se recomienda instalar una barrera física si hay personas en riesgo en la casa. Para restringir el acceso a una chimenea o estufa, instale una puerta de seguridad ajustable para mantener a los niños pequeños, jóvenes y otras personas en riesgo fuera del cuarto y lejos de las superficies calientes.
7. Cualquier malla o resguardo de seguridad quitado para dar servicio a un artefacto, debe reinstalarse antes de operar el artefacto.
8. Una persona de servicio competente debe realizar la instalación y reparación. Una persona de servicio profesional debe inspeccionar el artefacto antes de usar al menos una vez por año. Se puede requerir limpieza más frecuente debido a la pelusa excesiva del alfombrado, del material de cobijas, etc. Es imprescindible mantener limpios los compartimientos de control, los quemadores y los pasajes de circulación del aire del artefacto. Ver las instrucciones de mantenimiento en la página 10.

HOMEOWNER'S INSTRUCTIONS - ATTACHING SAFETY-IN-OPERATION WARNINGS

ATTACHING SAFETY-IN-OPERATION WARNINGS

Your fireplace has been furnished with safety instruction labels that are to be affixed to the operation and control point of the fireplace. A safety instruction label should be affixed to the wall switch plate where the fireplace is turned on and off (See **Figure A**) or wall thermostat (See **Figure B**) and if used on the remote control handheld transmitter (**Figure C**). The warnings should already have been put in place when the fireplace initial set-up was completed. If they are not affixed at these spots, locate the multi-lingual adhesive labels provided with these instructions and proceed as follows:

1. Locate the wall switch or wall thermostat that controls the fireplace (verify the switch operates the fireplace by turning it on and off). Clean the wall switch plate or wall thermostat thoroughly to remove any dust and oils. Affix the label to the surface of the plate of the wall switch that controls the fireplace (**Figure A**) or the wall thermostat (**Figure B**). Choose the language primarily spoken in the home.
2. If a remote control is used to control the fireplace, locate the transmitter and clean it thoroughly to remove any dust and oils. Affix the label to the surface of handheld transmitter (**Figure C**). Choose the language primarily spoken in the home.
3. If you are unable to locate the labels, please call Lennox Hearth Products or your nearest Lennox Hearth Products dealer to receive additional safety instruction labels free of charge.

Cat. No. H8024 Replacement Label Kit

LENNOX HEARTH PRODUCTS
1-800-9-LENNOX

Note: English is red text on clear label. French and Spanish are white text on black label.

SAFETY LABEL DIAGRAMS



Figure A



APPOSITION DES MISES EN GARDE RELATIVES À LA SÉCURITÉ D'UTILISATION

Votre foyer a été livré avec des étiquettes de sécurité qui doivent être collées à côté des dispositifs de contrôle du foyer. Une étiquette de sécurité doit être collée sur la plaque de l'interrupteur contrôlant l'allumage du foyer (voir **Figure A**) ou sur le thermostat mural (voir **Figure B**) et, le cas échéant, sur le boîtier de la télécommande (**Figure C**). Les mises en garde auraient dû être collées au moment de l'installation initiale du foyer. Si ce n'est pas le cas, prenez les étiquettes adhésives multilingues fournies avec ces instructions et procédez comme suit:

1. Repérez l'interrupteur ou le thermostat mural qui contrôle le foyer (vérifiez que l'interrupteur contrôle le fonctionnement du foyer en le faisant basculer de Marche à Arrêt, et vice-versa). Nettoyez soigneusement la plaque murale de l'interrupteur ou le thermostat mural pour éliminer la poussière et les traces de graisse ou d'huile. Collez l'étiquette sur la surface de la plaque de l'interrupteur mural qui contrôle le foyer (**Figure A**) ou du thermostat mural (**Figure B**). Choisissez la langue qui est principalement parlée dans la résidence du propriétaire.
2. Si une télécommande est utilisée pour contrôler le foyer, nettoyez la soigneusement pour éliminer la poussière et les traces de graisse ou d'huile. Collez l'étiquette sur le boîtier de la télécommande (**Figure C**). Choisissez la langue qui est principalement parlée dans la résidence du propriétaire.
3. Si vous ne trouvez pas les étiquettes, veuillez appeler Lennox Hearth Products ou votre distributeur Lennox Hearth Products local pour recevoir gratuitement des étiquettes supplémentaires.

Étiquettes de remplacement, n° cat. H8024

LENNOX HEARTH PRODUCTS
1-800-9-LENNOX

Remarque : Le texte anglais est rouge sur un support transparent. Le texte français et espagnol est blanc sur un support noir.

DIAGRAMMES DES ÉTIQUETTES DE SÉCURITÉ



Figure B



COLOCACIÓN DE ADVERTENCIAS DE SEGURIDAD EN OPERACIÓN

Su chimenea incluye etiquetas de instrucciones de seguridad que deben colocarse en el punto de operación y control de la chimenea. Se debe colocar una etiqueta de instrucciones de seguridad en la placa del interruptor de pared desde el cual se enciende y se apaga la chimenea (ver la **Figura A**) o en el termostato de pared (ver la **Figura B**) y en el transmisor de control remoto (**Figura C**) si se usa. Las advertencias ya deben haberse colocado cuando se completó la instalación inicial de la chimenea. Si no están colocadas en estos lugares, encuentre las etiquetas adhesivas multilingües proporcionadas con estas instrucciones y prosiga de la siguiente manera:

1. Identifique el interruptor o el termostato de pared que controla la chimenea (verifique que el interruptor opera la chimenea encendiéndola y apagándola). Limpie bien la placa del interruptor o el termostato de pared para quitar el polvo y aceite. Pegue la etiqueta en la superficie de la placa del interruptor que controla la chimenea (**Figura A**) o en el termostato de pared (**Figura B**). Seleccione el idioma que más se habla en la casa.
2. Si se usa un control remoto para controlar la chimenea, encuentre el transmisor y límpielo bien para quitar el polvo y aceite. Pegue la etiqueta en la superficie del transmisor (**Figura C**). Seleccione el idioma que más se habla en la casa.
3. Si no puede encontrar las etiquetas, sírvase llamar a Lennox Hearth Products o al distribuidor de Lennox Hearth Products más cercano para recibir etiquetas de instrucciones de seguridad adicionales gratuitas.

Juego de etiquetas de repuesto - N° de cat. H8024

LENNOX HEARTH PRODUCTS
1-800-9-LENNOX

Nota: La etiqueta en inglés es transparente con texto rojo. Las etiquetas en francés y español son negras con texto blanco.

DIAGRAMAS DE ETIQUETAS DE SEGURIDAD



Figure C



General Information

The fireplace models covered in this manual are direct-vent sealed combustion gas fireplace heaters designed for residential application. These direct-vent appliances operate with the combustion chamber completely isolated from the indoor environment.

All air for combustion is brought in from the outside and exhaust gases are vented through the same direct-vent, co-axial (intake/exhaust) vent system.

The *Millivolt* appliances have a millivolt gas control valve with piezo ignition system. If any optional accessories which require electrical power are being installed, the electrical power must be provided at the time of appliance installation.

The *Electronic* appliances are designed to operate on either natural or propane gas. An electronic intermittent pilot system provides safe, efficient operation. External electrical power is required to operate these units.

These appliances comply with National Safety Standards and are tested and listed by OMNI-Test Laboratories, Inc. (Report No. 116-F-05-5) to ANSI Z221.88 (in Canada, CSA-2.33), and CAN/CGA-2.17-M91 in both USA and Canada, as vented gas fireplace heaters.

The Installation must conform to local codes or, in the absence of local codes, with the National Fuel Gas Code, ANSI Z223.1/NFPA 54-latest edition, or the Natural Gas and Propane Installation Code, CAN/CSA B149.1-latest edition. The appliance, when installed, must be electrically grounded in accordance with local codes or, in the absence of local codes, the latest edition of the National Electrical Code, ANSI/NFPA 70, or the Canadian Electrical Code, CSA C22.1 - latest editions.

The vent termination is hot while in operation and for a period of time following the use of the fireplace. To prevent contact with hot surfaces, we recommend the use of a termination guard. See Page 20 for ordering information.

These fireplaces are designed as supplemental heaters. Therefore, it is advisable to have an alternate primary heat source when installed in a dwelling.

These appliances must not be connected to a chimney or flue serving a separate solid fuel burning appliance.

INSTALLATION, SERVICE, AND MAINTENANCE

IMPORTANT: Improper installation, adjustment, alteration, service, or maintenance can cause injury or property damage. Refer to this manual.

For assistance or additional information, consult a qualified installer, service agency or the gas supplier.

Only trim kit(s) supplied by the manufacturer shall be used in the installation of this appliance.

Draft relief openings must not be covered or blocked.

These appliances must not be connected to a chimney or flue serving a separate solid fuel burning appliance.

Any change to this appliance and/or its operating controls is dangerous.

Improper installation or use of this appliance can cause serious injury or death from fire, burns, explosion or carbon monoxide poisoning.

Carbon Monoxide Poisoning: Early signs of carbon monoxide poisoning are similar to the flu with headaches, dizziness and/or nausea. If you have these signs, obtain fresh air immediately. Turn off the gas supply to the appliance and have it serviced by a qualified professional, as it may not be operating correctly. Some people are more affected by carbon monoxide than others, including pregnant women, people with heart or lung disease or anemia, those under the influence of alcohol, and those at high altitudes.

Turn off gas and electrical power to the fireplace and allow it to cool before cleaning or servicing the appliance.

OPERATION

Do not operate appliance with the glass front removed, cracked, or broken.

These fireplaces are vented gas appliances. **Do not burn wood or other material in these appliances.**

This appliance is only for use with the type of gas indicated on rating plate.

This appliance is not convertible for use with other gases, unless a certified kit is used.

These appliances are designed to operate on natural gas or propane gas only. The use of other fuels or combinations of fuels will degrade the performance of this system and may be dangerous.

Provide adequate clearances around air openings and adequate accessibility clearance for service and proper operation. **Never obstruct the front openings of the appliance.**

Do not use this appliance if any part has been under water. Immediately call a qualified service technician to inspect the appliance and to replace any part of the control system and any gas control that has been under water.

WARRANTY

Failure to comply with the installation and operating instructions provided will result in an improperly installed and operating appliance, voiding its warranty.

Do not attempt to alter or modify the construction of the appliance or its components. **Any modification or alteration may void the warranty, certification, and listings of this unit.**

BTU Input

These fireplaces are designed as supplemental heaters. Therefore, it is advisable to have an alternate primary heat source when installed in a dwelling.

Millivolt Models - The millivolt appliances are manually controlled and feature a spark igniter (piezo) that allows the appliance's pilot gas to be lit without the use of matches or batteries. This system provides continued service in the event of a power outage.

Millivolt models come standard with a manually-modulated gas valve; flame appearance and heat output can be controlled at the gas valve. The BTU Input for these appliances is shown in **Table 1**.

Electronic Models - Electronic models have a fixed rate gas valve. Input of electronic models is shown in **Table 1**.

| Input (BTU/HR) Gas Valves (all models) | | |
|--|---------------------------|---------------------------|
| Models | Input Rate (BTU / HR) | |
| | Nat. Gas | Prop. Gas |
| EDV3530 (Millivolt) | 27,000 high 21,000 low | 27,000 high 20,700 low |
| EDV4035 (Millivolt) | 30,000 high 23,500 low | 30,000 high 24,200 low |
| EDV4540 (Millivolt) | 33,000 high 26,000 low | 33,000 high 26,500 low |
| EDV3530 (Electronic) | 27,000 | 27,000 |
| EDV4035 (Electronic) | 30,000 | 30,000 |
| EDV4540 (Electronic) | 33,000 | 33,000 |

Table 1

Gas Pressure - All Models

Tables 2 and 3 show the appliances' inlet and manifold gas pressure requirements:

| Inlet Gas Supply Pressure (all models) | | |
|--|------------------------|------------------------|
| Fuel # | Minimum | Maximum |
| Natural Gas | 4.5" WC (1.12 kPa) | 10.5" WC (2.61 kPa) |
| Propane | 11.0" WC (2.74 kPa) | 13.0" WC (3.23 kPa) |

Table 2

| Manifold Gas Supply Pressure (all models) | | |
|---|----------------------------|-----------------------------|
| Fuel # | Low | High |
| Natural Gas | (Lo) 2.2" WC (0.55 kPa) | (Hi) 3.5" WC (0.87 kPa) |
| Propane | (Lo) 6.3" WC (1.57 kPa) | (Hi) 10.0" WC (2.49 kPa) |

Table 3

Test gauge connections are provided on the front of the millivolt and electronic gas control valve (identified IN for the inlet and OUT for the manifold side). The control valves have a 3/8" (10mm) NPT thread inlet and outlet side of the valve (refer to **Figures 1 and 2**).

Propane tanks are at pressures that will cause damage to valve components. Verify that the tanks have step down regulators to reduce the pressure to safe levels.

| |
|--|
| These appliances must be isolated from the gas supply piping system (by closing their individual manual shut-off valve) during any pressure testing of the gas supply piping system at test pressures equal to or less than 1/2 psig (3.5 kPa). |
| These appliances and their individual shut-off valves must be disconnected from the gas supply piping system during any pressure testing of that system at pressures greater than 1/2 psig (3.5 kPa). |

These appliances must not be connected to a chimney or flue serving a separate solid fuel burning appliance.

Orifice Sizes - Sea Level to High Altitude (All Models)

These appliances are tested and approved for installation at elevations of 0-4500 feet (0-1372 meters) above sea level using the standard burner orifice sizes (marked with an "*" in **Table 4**).

For elevations above 4500 feet, contact your gas supplier or qualified service technician.

Deration - At higher elevations, the amount of BTU fuel value delivered must be reduced by either using gas that has been derated by the gas company or by changing the burner orifice to a smaller size as regulated by the local authorities having jurisdiction and by the (USA) National Fuel Gas Code NFPA 54/ANSI Z223.1 - latest edition or, in Canada, the CAN/CSA-B149.1 codes - latest edition.

Install the appliance according to the regulations of the local authorities having jurisdiction and, in the USA, the National Fuel Gas Code NFPA 54 / ANSI Z223.1 - latest edition or, in Canada, the CAN/CSA-B149.1 - latest edition.

Flame breadth, height and width will diminish 4% for every 1,000 feet of altitude.

| Burner Orifice Sizes Elevation 0-4500 feet (0-1372 meters) | | |
|--|---------------------------------|--------------------------------|
| Model Series | Nat. Gas drill size (inches) | Propane drill size (inches) |
| EDV3530 | #40 (0.0980")* 69L96• | #53 (0.0595")* 39L10• |
| EDV4035 | #36 (0.1065")* 18L40• | #52 (0.0635")* 37G00• |
| EDV4540 | #33 (0.1130")* 99K77• | #57 (0.0430")* H0922• |

Table 4 * Standard size installed at factory
• Part/Cat. Number

Burn-in Period

During the first few fires of this appliance there will be some odor due to the curing of the paint and burning off of lubricants used in the manufacturing process. Depending on your use, the burn-in period may take a few hours or a few days.

KEEP YOUR HOUSE WELL VENTILATED DURING THE CURING PROCESS. THE ODOR AND HAZE EMITTED DURING THE CURING PROCESS CAN BE QUITE NOTICEABLE AND MAY SET OFF A SMOKE DETECTOR.

If an optional blower is installed, Do Not turn it on during the Burn-In period.

A white film may develop on the glass front during the first few fires as part of the curing process. The glass should be kept clean during the first two weeks of use to prevent the film from baking on (making it very difficult to remove). See **Cleaning Glass** on **Page 10**.

OPERATION AND CARE OF YOUR APPLIANCE

WARNING

Young children should be carefully supervised when they are in the same room as the appliance. Toddlers, young children and others may be susceptible to accidental contact burns. A physical barrier is recommended if there are at risk individuals in the house. To restrict access to a fireplace or stove, install an adjustable safety gate to keep toddlers, young children and other at risk individuals out of the room and away from hot surfaces.

AVERTISSEMENT

Les jeunes enfants devraient être surveillés étroitement lorsqu'ils se trouvent dans la même pièce que l'appareil. Les tout petits, les jeunes enfants ou les adultes peuvent subir des brûlures s'ils viennent en contact avec la surface chaude. Il est recommandé d'installer une barrière physique si des personnes à risques habitent la maison. Pour empêcher l'accès à un foyer ou à un poêle, installez une barrière de sécurité; cette mesure empêchera les tout petits, les jeunes enfants et toute autre personne à risque d'avoir accès à la pièce et aux surfaces chaudes.

Gas Controls/Control Compartment Access

The gas controls can be found behind the hinged drop-down panel.

To open the hinged drop-down panel, actuate the spring loaded magnetic catches securing the door. First, gently depress the upper right top corner of the panel until the magnet catch "pops" the door free. Then, gently pulling the panel forward, disengage the left magnet catch and allow the panel to swing down to open.

On millivolt systems, the piezo ignitor, Hi/Lo flame adjustment knob, and pilot and main gas ON/OFF control knob are located on the modesty panel. On both millivolt and electronic systems the gas valve is located behind the modesty panel. See *Figure 1*.

Remove the bottom compartment door by sliding the hinge pin, located at the door's left side, to the right until it disengages from the left corner post hole. Pull the door diagonally to the left, away from the fireplace.

To ease door closure, depress the catches to place them in their retracted position until they stay there, then close the door.

Operation of millivolt and electronic gas control systems are different. Before lighting and operating your appliance determine if you have a millivolt or electronic appliance.

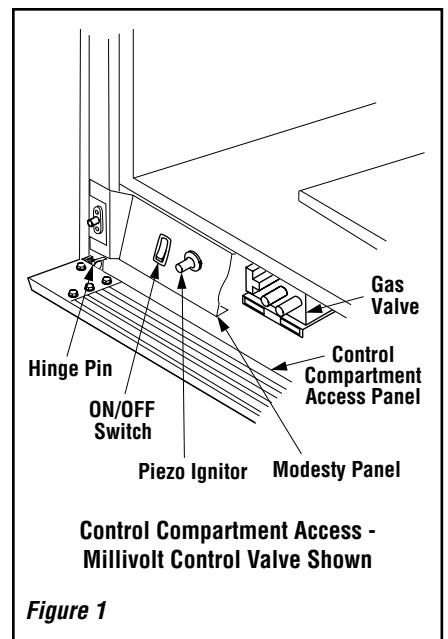

Refer to *Figure 1* for access to the gas control valve. Millivolt appliances will be fitted with the gas control valve shown in *Figure 2*.

Appliances with electronic systems will be fitted with the electronic valve shown in *Figure 3*. Familiarize yourself with the gas control valve that your appliance uses.

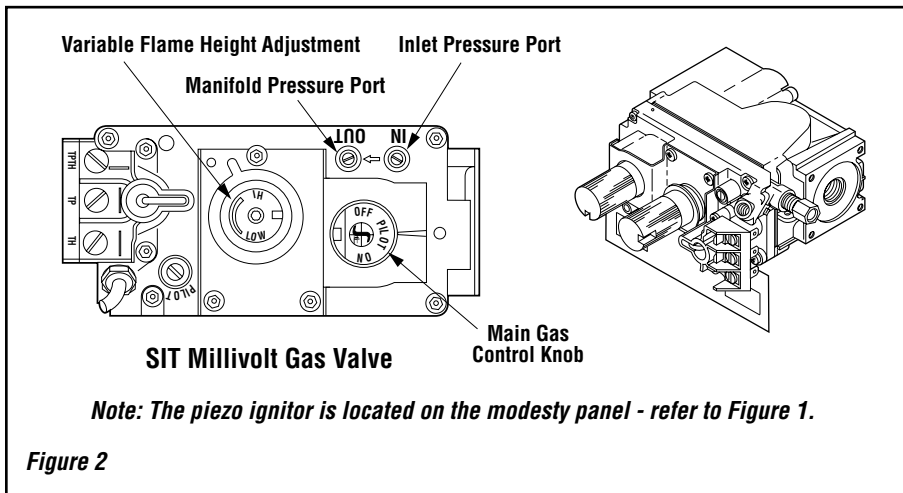

Variable Flame Height Adjustment (Millivolt Appliances only)

1. All Millivolt appliances are equipped with a variable gas control valve. Flame height for these models may be adjusted through a range between fixed low and high settings, alternately, while the appliance is in operation.

Adjust the flame height as desired after lighting the appliance by rotating the variable adjustment control knob located on the front of the valve (*refer to Figure 2*). (An extension is provided to this knob so that the adjustment may be made at the modesty panel.)

2. When lit for the first time, this appliance will emit a slight odor for an hour or two. This is due to the "burn-in" of internal paints and lubricants used in the manufacturing process.

3. Keep lower control compartment clean by vacuuming or brushing at least twice a year. More frequent cleaning may be required due to excessive lint from carpeting, bedding materials, etc. It is important that control compartments, burners and circulating air passageways of the appliance be kept clean and clear of obstruction of venting and combustion air.

4. Always turn off gas to the pilot (millivolt appliances) before cleaning. Before re-lighting, refer to the lighting instructions in this manual. Instructions are also found on a pull-out panel located on the floor of the appliance.

5. Always keep the appliance area clear and free from combustible materials, gasoline and other flammable liquids.

6. Remember, Millivolt appliances have a continuous burning pilot flame. Exercise caution when using products with combustible vapors.

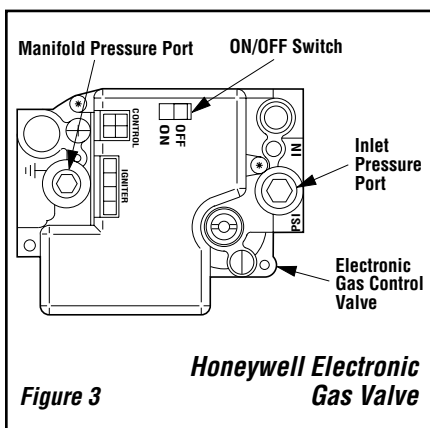

If your millivolt appliance is equipped with an optional remote wall switch or remote control kit and the pilot is lit, the appliance main burner may be turned on and off with the wall switch or remote control.

Electronic Appliances -

To light electronic appliances refer to the detailed lighting instructions found in both English and French on *pages 26 and 27* of these instructions respectively. **Electronic appliance lighting instructions may also be found on the pull out lighting instruction labels attached to the gas control valve.** Electronic appliances are fitted with an ON/OFF Rocker Switch for appliance ON/OFF control. Refer to *Figure 1* for its location.

Once the pilot is lighted, the ON/OFF rocker switch will control the appliance ON/OFF operation. To operate: Toggle the switch between its ON and OFF positions.

If your electronic appliance is equipped with an optional remote wall switch or remote control kit the appliance main burner may be turned on and off with the wall switch or remote control.

Millivolt Appliances -

To light millivolt appliances refer to the detailed lighting instructions found on *page 24 (English) and page 25 (French)*. **Millivolt appliance lighting instructions may also be found on the pull out lighting instruction labels attached to the gas control valve.**

Millivolt appliances are fitted with an ON/OFF Rocker Switch for appliance ON/OFF control. Refer to *Figure 1* for its location. Once the pilot is lighted, the ON/OFF rocker switch will control the appliance ON/OFF operation. To operate: Toggle the switch between its ON and OFF positions.

MAINTENANCE

(See Maintenance Schedule, *Page 23*)

Refer to the maintenance schedule for maintenance tasks, procedures, periodicity and by whom they should be performed. Always verify proper operation of the appliance after servicing.

WARNING

Turn off gas and electrical power to the fireplace and allow it to cool before cleaning or servicing the appliance.

CAUTION: Wear gloves and safety glasses for protection while doing required maintenance.

Verify proper operation after servicing.

S'assurer que l'appareil fonctionne adéquatement une fois l'entretien terminé.

Always turn off gas to the pilot (millivolt appliances) before cleaning. Before re-lighting, refer to the lighting instructions in this manual. Instructions are also found on a pull-out panel located in the control compartment.

Inspect Venting System

The appliance and venting system should be thoroughly inspected before initial use and at least annually by a qualified service technician (inspection should include ensuring that exhaust or intake passages are unobstructed and vent components are properly assembled and not damaged). **Homeowner must contact a qualified service technician at once if any abnormal condition is observed.**

If the venting system is disassembled for any reason, a qualified service technician should follow vent installation instructions for proper reassembly and proper sealing of the venting system components. However, more frequent periodic inspections and cleanings should be performed by the homeowner.

Cleaning Glass

(see *Front Glass Enclosure Panel, Removal and Installation* on *Page 11*).

Note: Clean glass after first two weeks of operation (after Burn-In period is over) and then only when necessary and when the fireplace is cool. Wipe surface with a clean, dampened, soft cloth. Follow with a dry, soft towel as desired. Take care not to scratch the glass surface.

The viewing glass should be cleaned periodically to remove any build-up caused from the following:

IMPORTANT: Do not use abrasive cleaners on glass. Never clean the glass when it is hot.

- During start-up, it is normal for condensation to form on the inside of the glass (this condensation and fog will usually disappear in a few minutes). The moisture can cause lint, dust and other airborne particles to cling to the glass surface.
- Initial curing of the high temperature paint and burning off of lubricants used in the manufacturing process may result in a film on the glass.
- A white coating may form on the glass as a result of impurities and minerals in the fuel.

It is recommended that the glass be cleaned two or three times during each heating season, depending on the circumstances present. The following cleaning solutions are approved for use to clean glass:

- Non-ammonia based household cleaner
- 50%-50% mix of white vinegar and water
- Gas fireplace/stove glass cleaner

Inspect Glass Gasket - Visually inspect the gasket on the backside of the glass enclosure panels. The gasket surface must be clean, free of irregularities and seated firmly.

Clean Control Compartment

Keep control compartment clean by vacuuming or brushing at least twice a year. More frequent cleaning may be required due to excessive lint from carpeting, bedding materials, etc. It is important that control compartments, burners and circulating air passageways of the appliance be kept clean.

Clean Logs And Burner

Carefully remove the logs (use care when handling the fiber logs, as they become quite fragile after curing). Vacuum out any foreign matter (lint, carbon, etc.) on the burner. Ensure the burner ports are "open." Remove any carbon deposits from the under side of the logs using a vacuum cleaner, or a soft bristled brush (i.e. paint brush).

Note: Improper positioning of logs can create carbon build-up and will alter the performance of the appliance.

Replacing Logs

If the logs become damaged by accident or improper handling and need replacement, use only the proper replacement logs from manufacturer (see *Pages 11 and 12* for ordering information).

Re-Install Embers and Logs

Carefully follow placement instructions on *Pages 12 through 14*. All logs should fit onto corresponding pins and/or log stoppers. This will ensure a proper flame and safe combustion.

Inspect Wiring

Refer to wiring diagrams on *Page 17*.

CAUTION: Label all wires prior to disconnection when servicing controls. Wiring errors can cause improper and dangerous operation. Verify proper operation after servicing.

ATTENTION: Au moment de l'entretien des commandes, étiquetez tous les fils avant de les débrancher. Des erreurs de câblage peuvent entraîner un fonctionnement inadéquat et dangereux.

Inspect and clean all wire connections. Ensure that there is no melting or damage. Inspection should include:

- Terminals at the Valve
- OFF/ON Switch
- (Optional Control Switch) Wall Thermostat, Remote Control or Remote Wall Switch Kit

Inspect Burner Flame Appearance

Ensure that the burner flame appearance resembles the flame shown in *Figures 11 and 12* and as described in *Flame Appearance and Sooting* on *Page 15*. The Homeowner must contact a qualified service technician at once if any abnormal condition is observed.

Small Area Paint Touch-up

Only use a factory supplied paint kit for touch-ups. Paint is available at your local authorized Lennox Hearth Products dealer. Never attempt to paint a hot fireplace.

Do not attempt to repaint the appliance until the finish is completely cured (see *Burn-In Period* on *Page 7*). If the surface later becomes stained or marred, it may be lightly sanded and touched up with spray paint.

Front Glass Enclosure Panel, Removal and Installation

! WARNING

- Do not attempt to substitute the materials used on this door, or replace cracked or broken glass.
- Handle this glass with extreme care! Glass is susceptible to damage – Do not scratch or handle roughly while reinstalling the glass door frame.
- The glass door(s) of this appliance must only be replaced as a complete unit as provided by the manufacturer. Do not attempt to replace broken, cracked or chipped glass separately.
- Do not attempt to touch the front enclosure glass with your hands while the fireplace is in use.

! WARNING

Do not operate appliance with the glass front removed, cracked or broken.

! AVERTISSEMENT

Ne pas utiliser l'appareil si le panneau frontal en verre n'est pas en place, est craqué ou brisé.

! WARNING

Any safety screen or guard removed for servicing the appliance must be replaced prior to operating the appliance.

! AVERTISSEMENT

Tout écran ou protecteur retiré pour permettre l'entretien de l'appareil doit être remis en place avant de mettre l'appareil en marche.

Only doors certified with the appliance shall be used.

Seules des portes certifiées pour cet appareil doivent être utilisées.

CAUTION: DO NOT abuse glass door by striking or slamming shut.

These are direct-vent appliances. They are designed to operate only when the front glass enclosure panels are installed. Generally the front glass enclosure panel should not be removed except to gain access to the components within the firebox.

Removing Glass Enclosure Panels (see *Figure 4*)

Remove the top bustle (door trim) and the top louver assembly or radiant panel. Remove the bottom bustle (door trim).

To access the glass door securing latches, first open the lower control compartment door (*Figure 4*) by pushing in simultaneously the left and right top corners of the door. (The door is hinged at the bottom.) Remove the bottom compartment door by sliding the hinge pin, located at the door's left side, to the right until it disengages from the left corner post hole. Pull the door diagonally to the left, away from the fireplace.

Locate the two (2) latches at the top of the control compartment and disengage them from the door frame bottom vee-flange, pulling down on their handles to open them.

Retrieve the glass door. Visually inspect the gasket on the backside of the frame. Gasket surface must be clean, free of irregularities and seated firmly.

Position the door in front of the firebox opening with the bottom of the door held away from the fireplace (*Figure 4*). Hook the top flange of the door frame over the top of the firebox frame.

Let the bottom of the door frame swing gently in towards the fireplace ensuring that the gasket seats evenly as the door frame draws shut. Fasten the two latches located underneath the firebox floor to the door's vee-flange. Close both the latches securely.

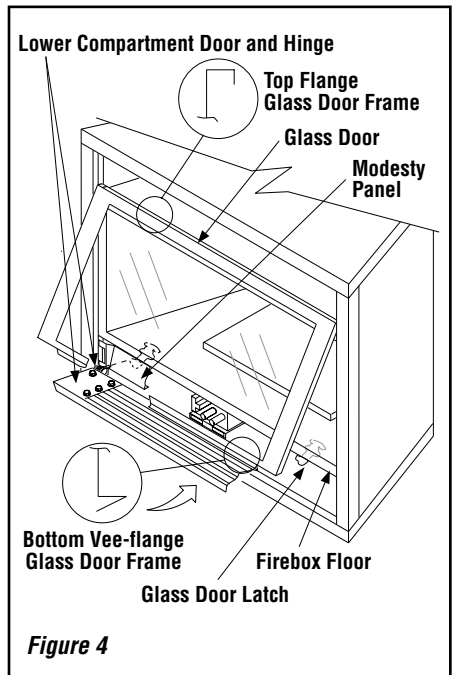

INSTALL VOLCANIC STONE, GLOWING EMBERS AND LOGS

NOTE: Turn off all electricity to the appliance before you install volcanic stone, embers and logs. DO NOT attempt to install the logs until the appliance installation has been completed, the gas line connected and tested for leaks and the initial burner operation has been checked out.

Step 1. Remove the appliance front door (see Removing Glass Enclosure panel on **page 11**).

Step 2. Install decorative volcanic stone -

Sprinkle the decorative volcanic stone in a pleasing pattern. The volcanic stone should be placed directly on top of the firebox bottom, along the front and to the back at the right and left sides of the burner. Position any optional ceramic fiber liners before placing the stone. Logs should be positioned after the volcanic stone.

Note: This appliance is provided with enough Glowing Embers for several applications, do not feel compelled to use all that is in a new bag. For best glowing effect, replace the ember material annually. Replacement Glowing Embers are available (Catalog Number 88L53).

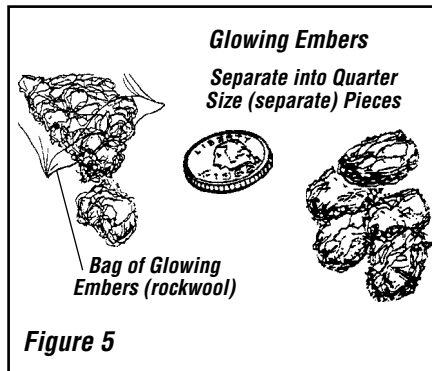

Step 3. Separate the Glowing Ember (Rockwool) into pieces about the size of a quarter (**Figure 5**). Keep the pieces fluffed up, not matted. Distribute these pieces over the front surface of the burner, as shown in **Figure 6**. Do not use more than is necessary. When properly positioned, the Glowing Embers will cover approximately 65% of the front burner and with no appreciable gaps or openings. Ensure that the main burner ports remain uncovered by the ember material.

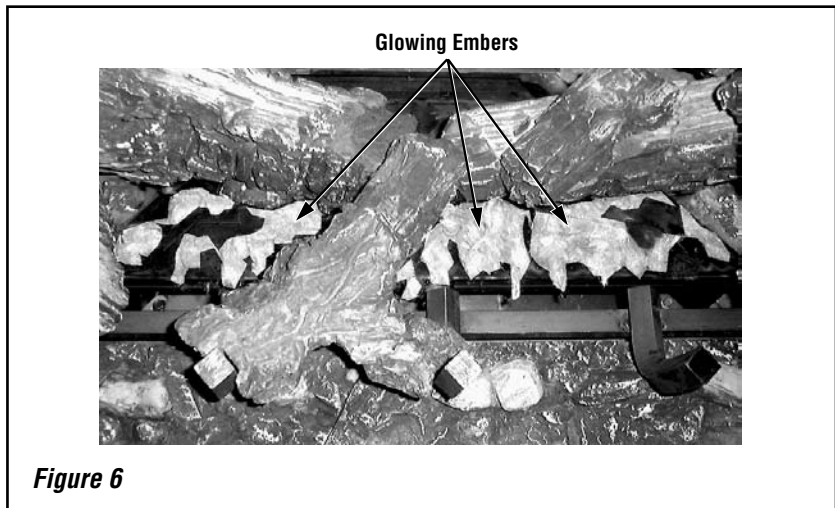

Step 4. Placement of Logs -

All top logs that rest on lower logs, do so over notches, indents or nubs. Proper log placement is critical to prevent sooting. Logs should be placed in the gaps between the flame peaks and should be positioned so they do not impinge the flames.

Step 5. Position the individual logs as shown in **Figures 7 and 8**. Logs should be placed in the order shown. All logs that have notches to fit over the grate tines should be positioned with these notches directly against the grate. **Handle logs carefully to prevent breakage.**

Proper log placement is critical to encourage outstanding flame appearance and prevent sooting. When positioned properly as shown, logs will be positioned between flame peaks and will not impinge any flames.

Refer to **Figure 7** for EDV3530 Series appliances and to **Figure 8** for EDV4035 & EDV4540 Series appliances.

| REFERENCE Firebox Accessories / Parts | | |
|--|-----------|----------------------------------|
| Cat. No. | Model No. | Description |
| 88L53 | FGE | Bag of Glowing Embers |
| 80L42 | FDVS | Bag of Decorative Volcanic Stone |

! WARNING

- **DO NOT** attempt to install the logs until the appliance installation has been completed, the gas line connected and tested for leaks and the initial burner operation has been checked out.
- The size and position of the log set was engineered to give the appliance a safe, reliable and attractive flame pattern. Any attempt to use a different log set in the fireplace will void the warranty and will result in incomplete combustion, sooting, and poor flame quality.
- Logs get very hot and will remain hot up to one hour after gas supply is turned off. Handle only when logs are cool. Turn off all electricity to the appliance before you install grate, volcanic stone, vermiculite, embers and logs.
- This appliance is not designed to burn wood. Any attempt to do so could cause irreparable damage to the appliance and prove hazardous to your safety.
- If logs are not installed according to the log installation instructions, flame impingement and improper combustion could occur and result in soot and/or excessive production of carbon monoxide (CO), a colorless, odorless, toxic gas.

EDV3530 LOG PLACEMENT

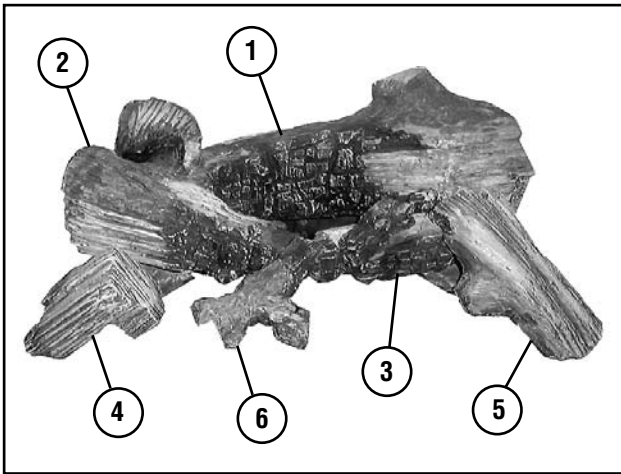

| Log Number | Description | Part Number |
|------------|---------------------|-------------|
| 1 | Log, Rear | 55M06 |
| 2 | Log, Diagonal/Left | 55M07 |
| 3 | Log, Diagonal/Right | 55M08 |
| 4 | Log, Front/Left | 55M09 |
| 5 | Log, Top/Right | 55M10 |
| 6 | Log, Front/Center | 55M11 |

Catalog Number for the entire log set: 55M02

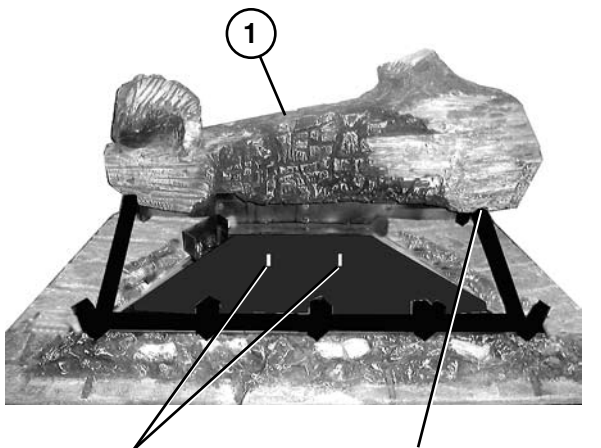

Locating Pins

Align Groove At The Bottom Of Log (1) Over The Grate And Push It Towards The Rear.

Align The Hole On The Log (5) Over The Locating Pin And Position The Notch Over The Grate As Shown

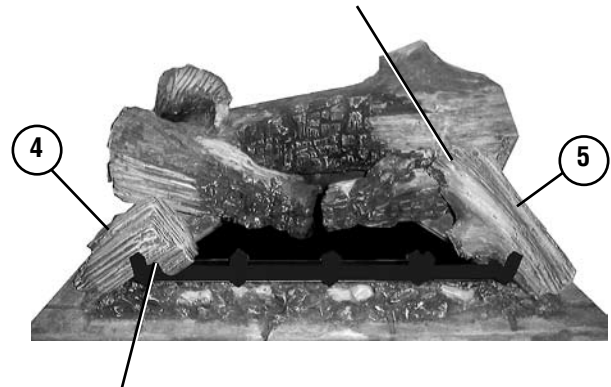

Align The Groove In The Bottom Of Log (4) Over The Grate And Slide It Toward The Front.

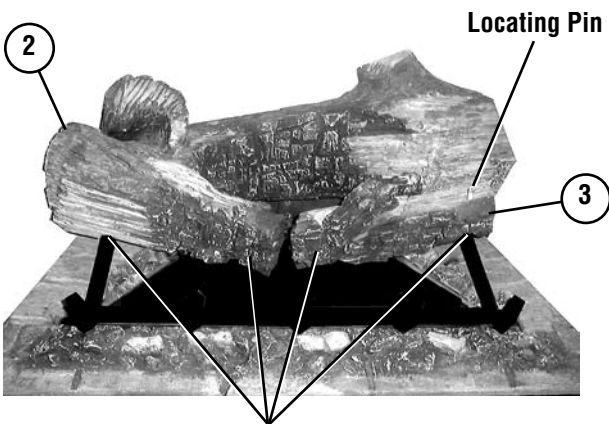

Align The Holes In One End Of Logs 2 & 3 Over The Locating Pins And Align The Grooves On The Other End Over The Grate And Push It Toward The Rear

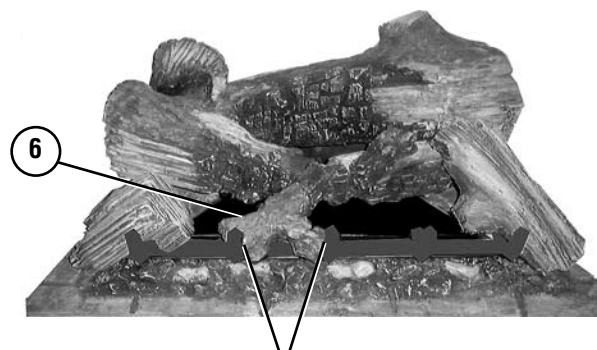

Position The Grooves On Log (6) Against The Grate As Shown

Figure 7

EDV4035 & EDV4540 LOG PLACEMENT

| Log Number | Description | Part Number |
|------------|---------------------|-------------|
| 1 | Log, Rear | 55M12 |
| 2 | Log, Diagonal/Left | 55M13 |
| 3 | Log, Diagonal/Right | 55M14 |
| 4 | Log, Front/Left | 55M15 |
| 5 | Log, Top/Right | 55M16 |
| 6 | Log, Front/Center | 55M17 |

Catalog Number for the entire log set: 55M03

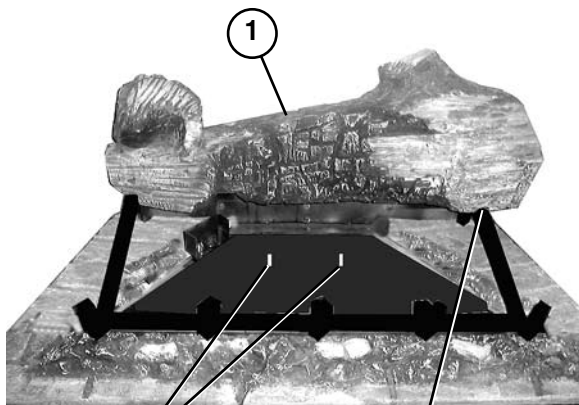
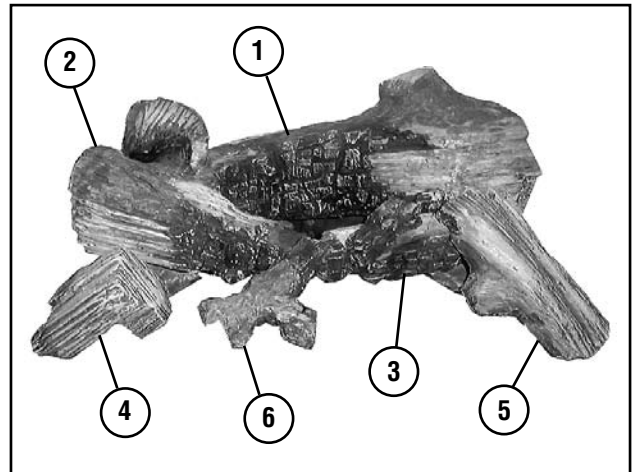

Locating Pins

Align Groove At The Bottom Of Log (1) Over The Grate And Push It Towards The Rear.

Align The Hole On The Log (5) Over The Locating Pin And Position The Notch Over The Grate As Shown

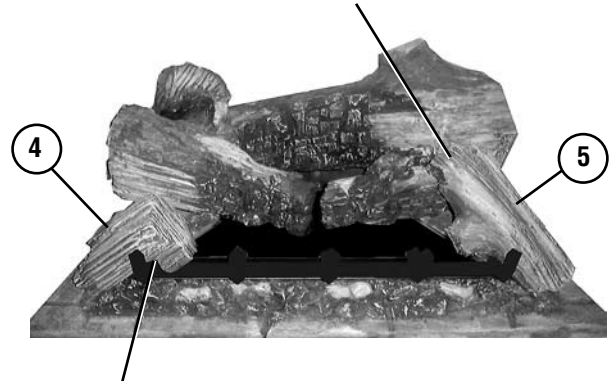

Align The Groove In The Bottom Of Log (4) Over The Grate And Slide It Toward The Front.

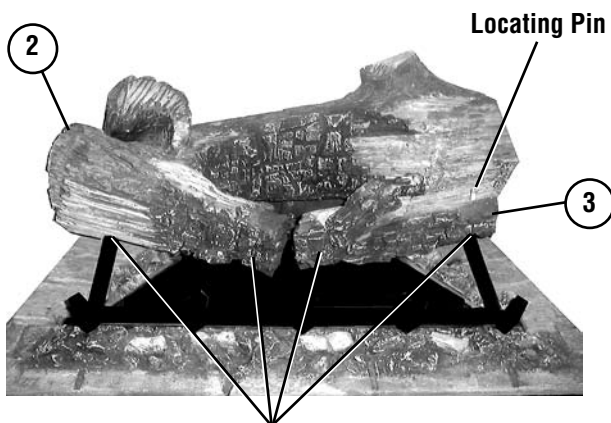

Align The Holes In One End Of Logs 2 & 3 Over The Locating Pins And Align The Grooves On The Other End Over The Grate And Push It Toward The Rear

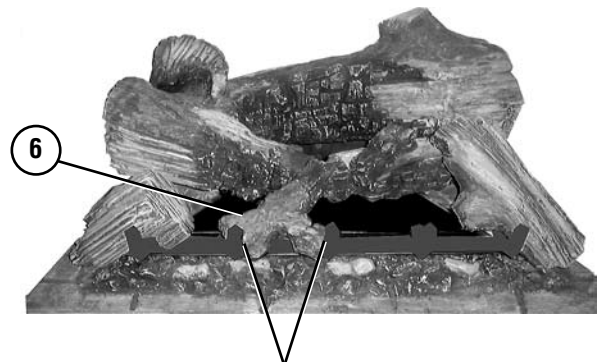

Position The Grooves On Log (6) Against The Grate As Shown

Figure 8

**BURNER ADJUSTMENTS
(QUALIFIED TECHNICIANS ONLY)**

Flame Appearance and Sooting

Proper flame appearance is a flame which is blue at the base and becomes yellowish-orange in the body of the flame.

When the appliance is first lit, the entire flame may be blue and will gradually turn yellowish-orange during the first 15 minutes of operation. If the flame remains blue, or if the flame is orange with evidence of sooting (black tip), the air shutter opening may need to be adjusted.

If the air shutter opening is closed too far, sooting may develop. Sooting is indicated by black puffs developing at the tips of very long orange flames. Sooting results in black deposits forming on the logs, appliance inside surfaces and on exterior surfaces adjacent to the vent termination.

Sooting is caused by incomplete combustion in the flames and lack of combustion air entering the air shutter opening. To achieve a warm yellowish-orange flame with an orange body that does not soot, the shutter opening must be adjusted between these two extremes.

Air Shutter Adjustment Guidelines

- If there is smoke or soot present, first check the log set positioning to ensure that the flames are not impinging on any of the logs. If the log set is properly positioned and a sooting condition still exists, then the air shutter opening should be increased.
- The more offsets in the vent system, the larger the air shutter opening will need to be.
- An appliance operated with the air shutter opened too far, may have flames that appear blue and transparent. These weak, blue and transparent flames are termed anemic.
- Propane models may exhibit flames which candle or appear stringy. If this is present and persists, adjust the air shutter to a more closed position, then operate the appliance for a few more minutes to ensure that the flame normalizes and the flames do not appear sooty.

The following chart is provided to aid you in achieving the correct air shutter adjustment for your installation.

| Air Shutter Adjustment Guidelines: | | |
|---------------------------------------|---------------------------|-------------------------------------|
| Amount of Primary Air | Flame Color | Air Shutter Adjustment |
| If air shutter is closed too far → | Flame will be orange → | Air shutter gap should be increased |
| If air shutter is open too far → | Flame will be blue → | Air shutter gap should be decreased |

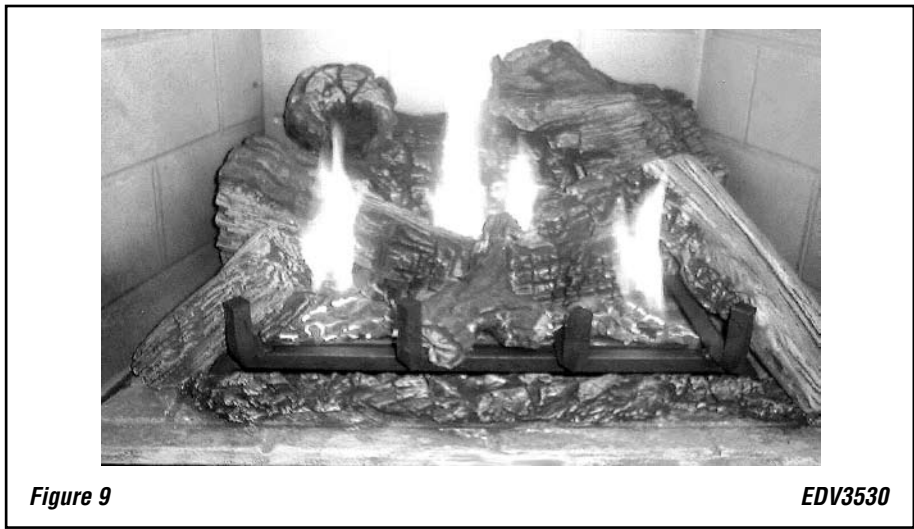

Figure 9

EDV3530



Figure 10

EDV4035

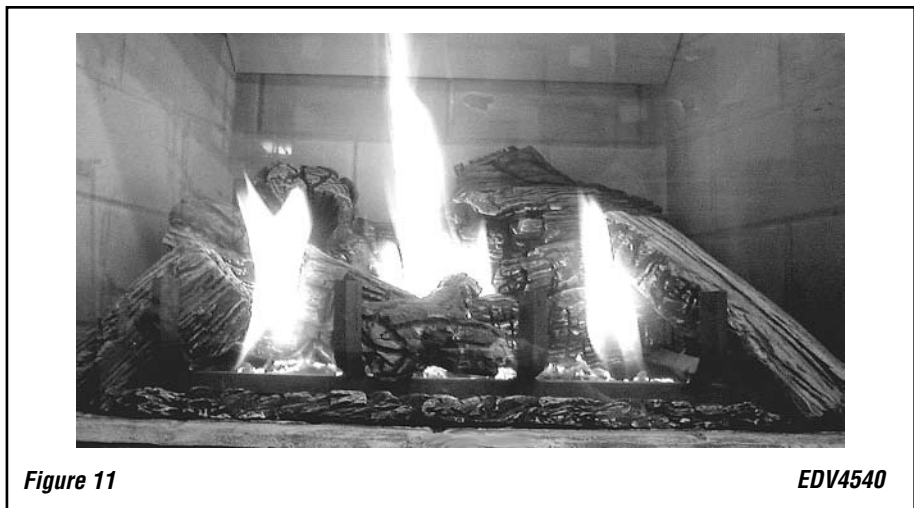

Figure 11

EDV4540

BURNER FLAME ADJUSTMENTS

⚠ WARNINGS

- Air shutter adjustment should only be performed by a qualified professional service technician.
- Ensure front glass panel are in place and sealed during adjustment.

⚠ CAUTIONS

- Soot will be produced if the air shutter is closed too much. Any damage due to sooting, resulting from improperly setting the air shutter, is not covered under the warranty.
- The air shutter door and nearby appliance surfaces are hot. Exercise caution to avoid injury while adjusting flame appearance.

1. Refer to **Figures 9, 10 and 11** for proper flame appearance. To adjust the flame, rotate the adjustment rod toward the back or toward the front of the fireplace (rod located in the lower control area). Position the air shutter to the factory setting as shown in the table in **Figure 12**.
2. Light appliance (follow lighting procedure on lighting label in control compartment or see the Care and Operation Manual).
3. Allow the burner to operate for at least 15 minutes while observing the flame continuously to ensure that the proper flame appearance has been achieved. If the following conditions are present, adjust accordingly.
 - If flame appears weak or sooty, adjust the air shutter, incrementally, to a more open position until the proper flame appearance is achieved.
 - If flame remains blue, adjust the air shutter, incrementally, to a more closed position until the proper flame appearance is achieved.
4. Leave the control knob (off/pilot/on) in the ON position and the burner OFF/ON switch OFF (and remote switches, if applicable).
5. When satisfied that the burner flame appearance is normal, re-install the lower control compartment door then proceed to finish the installation.

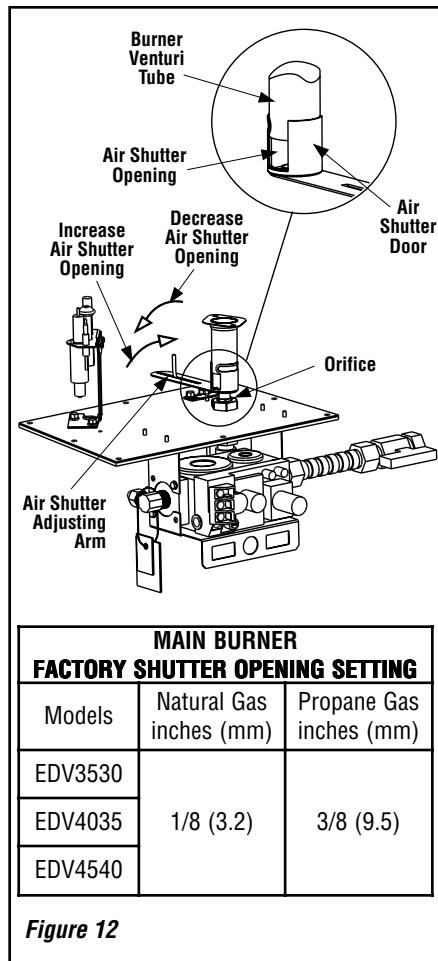

Figure 12

Millivolt Appliance Checkout

The pilot flame should be steady, not lifting or floating. Flame should be blue in color with traces of orange at the outer edge.

The top 3/8" (10 mm) at the pilot generator (thermopile) and the top 1/8" minimum (tip) of the quick drop out thermocouple should be engulfed in the pilot flame.

The flame should project 1" (25 mm) beyond the hood at all three ports (see **Figure 13**). Replace logs if removed for pilot inspection.

To light the burner; turn "ON" the remote wall switch and rotate the gas valve control knob counterclockwise to the "ON" position ("ON" will be at the top side of the valve).

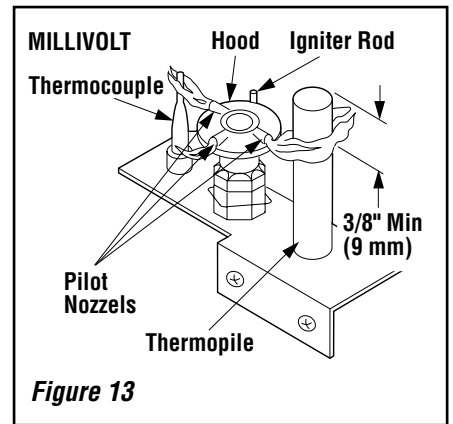

Figure 13

Electronic Appliance Checkout

To light the burner, turn 'ON' the unit mounted On/Off switch or the optional remote wall switch. Ensure the igniter lights the pilot. The pilot flame should engulf the flame rod as shown in **Figure 14**.

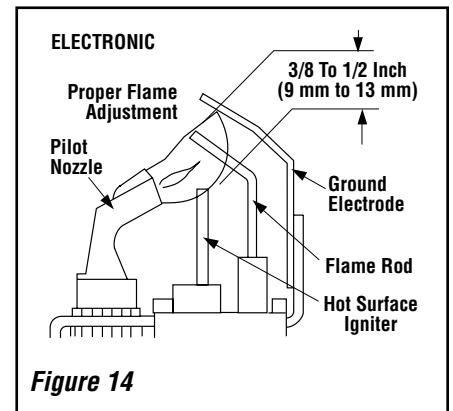
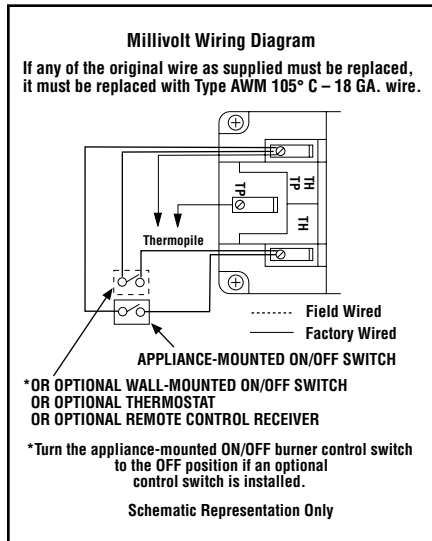

Figure 14

WIRING DIAGRAMS

Wiring diagrams are provided here for reference purposes only. This information is also provided on schematics attached directly to the appliance on a pullout panel located within the control compartment.

CAUTION: LABEL ALL WIRES PRIOR TO DISCONNECTION WHEN SERVICING CONTROLS. WIRING ERRORS CAN CAUSE IMPROPER AND DANGEROUS APPLIANCE OPERATION.



ATTENTION: AU MOMENT DE L'ENTRETIEN DES COMMANDES, ÉTIQUETEZ TOUS LES FILS AVANT DE LES DÉBRANCHER. DES ERREURS DE CÂBLAGE PEU-VENT ENTRAÎNER UN FONCTIONNEMENT INADÉQUAT ET DANGEREUX.

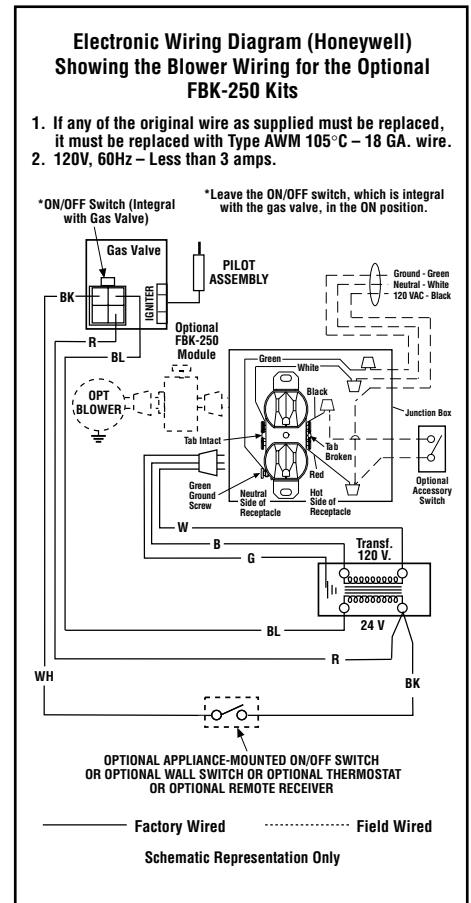
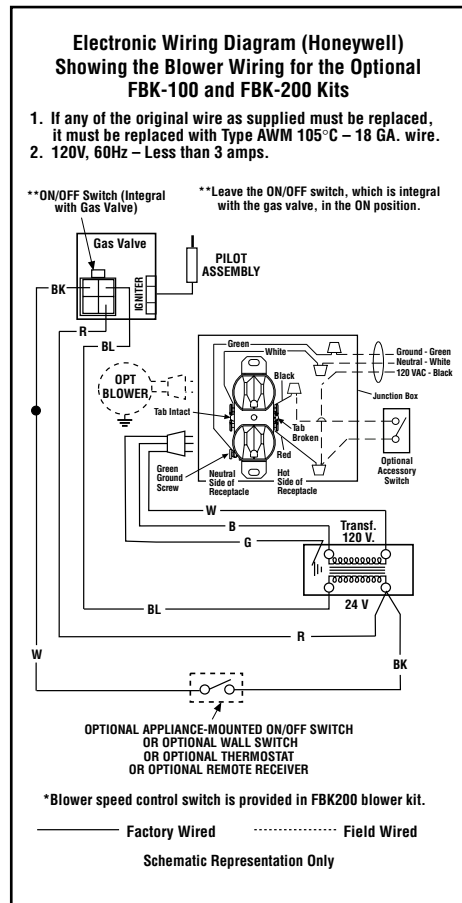

WARRANTY

Your gas appliance is covered by a twenty year limited warranty. You will find a copy of the warranty accompanying this manual. Please read the warranty to be familiar with its coverage.

Retain this manual. File it with your other documents for future reference.

REPLACEMENT PARTS

A complete parts list is found at the end of this manual. Use only parts supplied from the manufacturer.

With proper care and maintenance, your appliance will provide many years of enjoyment. If you should experience any problem, first refer to the troubleshooting guide in this manual. If problem persists, contact your Lennox Hearth Products dealer or distributor.

Normally, all parts should be ordered through your Lennox Hearth Products distributor or dealer.

Parts will be shipped at prevailing prices at time of order.

When ordering repair parts, always give the following information:

1. The model number of the appliance.
2. The serial number of the appliance.
3. The part number.
4. The description of the part.
5. The quantity required.
6. The installation date of the appliance.

If you encounter any problems or have any questions concerning the installation or application of this system, please contact your dealer or distributor.

LENNOX HEARTH PRODUCTS
1508 Elm Hill Pike, Suite 108
Nashville, TN 37210
visit us at www.Lennox.com
1-800-9-LENNOX

PRODUCT REFERENCE INFORMATION

We recommend that you record the following important information about your fireplace. Please call Lennox Hearth Products for the phone number of your nearest Lennox Hearth Products dealer who will answer your questions or address your concerns.

Your Fireplace's Model Number _____
Your Fireplace's Serial Number _____
The Date On Which Your Fireplace Was Installed _____
The Type of Gas Your Fireplace Uses _____
Your Dealer's Name _____

ACCESSORY COMPONENTS

| Product Reference Information | | | |
|-------------------------------|-----------|--------------|---------------|
| Cat. No. | Model | Ship. Weight | Ship. Volume |
| H2000 | EDV3530NM | 78 lb. | 9.09 cu. ft. |
| H2001 | EDV3530PM | 78 lb. | 9.09 cu. ft. |
| H2006 | EDV3530NE | 78 lb. | 9.09 cu. ft. |
| H2002 | EDV4035NM | 86 lb. | 10.61 cu. ft. |
| H2003 | EDV4035PM | 86 lb. | 10.61 cu. ft. |
| H2007 | EDV4035NE | 86 lb. | 10.61 cu. ft. |
| H2004 | EDV4540NM | 108 lb. | 14.01 cu. ft. |
| H2005 | EDV4540PM | 108 lb. | 14.01 cu. ft. |
| H2008 | EDV4540NE | 108 lb. | 14.01 cu. ft. |



Digital Wall Thermostat

The wall thermostat kit provides temperature control for optimum comfort.

| Wall Thermostat, Millivolt | | |
|----------------------------|-----------|----------------------------|
| Cat. No. | Model No. | Description |
| H4635 | DWTK | Wall Thermostat Kit, White |



Remote Control System (Standard) H0249 RCL

Standard Remote Control System

The Model RCL (Standard) Remote Control System, features a simple On/Off control function for the fireplace. This model includes a hand-held transmitter, a remote receiver with wall-mount coverplate and all hardware required to install the unit. The remote receiver can be wall or hearth mounted.



Flame Modulating Remote Control - Natural Gas H0301 RCL-MN
 Flame Modulating Remote Control - LP/Propane Gas H0302 RCL-ML

Flame Modulating Remote Control

Flame Modulating Remote Controls were developed to provide a safe, reliable and user-friendly remote control system for appliances equipped with a Millivolt Gas Valve. A detailed set of instructions are included with each remote.



Remote Control System (Deluxe) H0251 RCL-T

Deluxe Remote Control System

The Model RCL-T (Deluxe) Remote Control System has all of the features of the standard system along with an added easy to read LCD screen which presents access to many enhancements, including; battery power level indicator, timer, mode of operation, thermostatic display including room temperature in either metric of English units, flame indicator and clock. Fully programmable, the Model RCL-T allows for command over nearly all operational and temperature variables, using the hand held remote control transmitter.

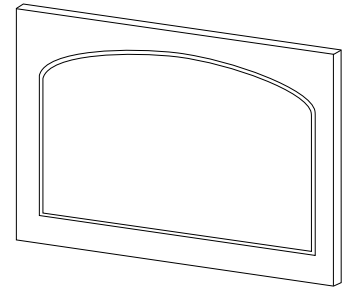

The kits attach to the glass enclosure panel without the use of hardware. The decorative arch kits can **not** be used in conjunction with the screen panel kit.

| Arch Door Kits | | |
|----------------|-----------------------|-------------------|
| Model No. | Catalog No. Model No. | |
| | Polished Brass | Brushed Stainless |
| EDV3530 | 81L34 | 98L68 |
| | ADK35CPB | ADK35CBS |
| EDV4035 | 81L35 | 98L69 |
| | ADK40CPB | ADK40CBS |
| EDV4540 | 81L36 | 98L70 |
| | ADK45CPB | ADK45CBS |

ACCESSORY COMPONENTS CONTINUED

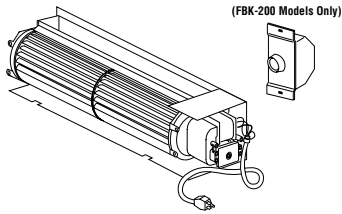

| | | |
|--|-------|---------|
| Forced Air Blower Kits | | |
| -Single Speed | 80L84 | FBK-100 |
| -Variable Speed with wall-mountable switch | 80L85 | FBK-200 |
| -Variable Speed with unit-mountable switch | 80L86 | FBK-250 |

Forced Air Kit

The FBK-100 blower provides constant velocity forced air circulation. The FBK-200 assembly with variable speed, wall-mountable switch provides variable speed forced air circulation. The FBK-250 assembly with variable speed unit-mountable switch, also provides variable speed forced air circulation.

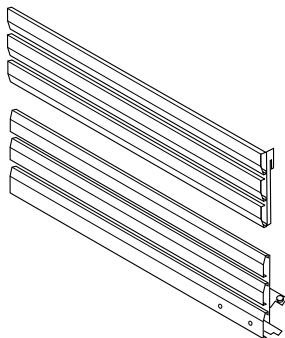

| Assembled Louver Kits | | |
|-----------------------|-----------------------|-------------------|
| Model No. | Catalog No. Model No. | |
| | Polished Brass | Brushed Stainless |
| EDV3530 | 88L28 | 88L32 |
| | LVR35PB-2 | LVR35BS |
| EDV4035 | 88L29 | 88L33 |
| | LVR40PB-2 | LVR40BS |
| EDV4540 | 88L30 | 88L34 |
| | LVR45PB-2 | LVR45BS |

These louvers are designed to replace the standard charcoal louvers that are provided with the appliance. The brass and brushed stainless louver kits include six (6) louvers.

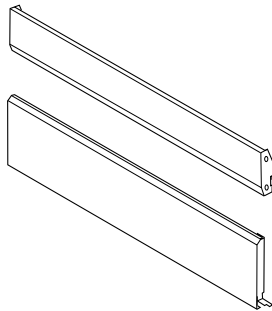

| Clean Face Panel Kits | |
|-----------------------|-----------------------|
| Model No. | Catalog No. Model No. |
| EDV3530 | 88L36 RAD35C-2 |
| | 88L37 RAD40C-2 |
| EDV4035 | 88L38 RAD45C-2 |
| | 88L39 RAD45C-2 |

Clean faced panel kits are available to convert the standard louvered fireplaces to radiant models which are more suited for finishing around the firebox opening with non-combustible materials, such as tile.

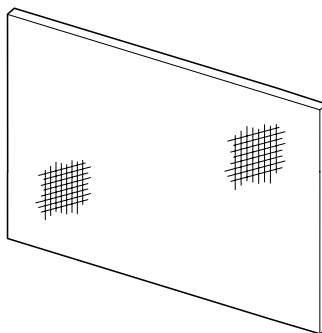

| Screen Panel Kits | |
|-------------------|-----------------------|
| Model No. | Catalog No. Model No. |
| EDV3530 | 88L52 HG35E |
| | 96K32 HG40 |
| EDV4035 | 96K33 HG45 |
| | 96K34 HG45 |

These screen panels can be installed on the glass enclosure panel to provide protection from the hot glass surface. The screen panel kits cannot be used in conjunction with either of the arch door kits or door frame kits.

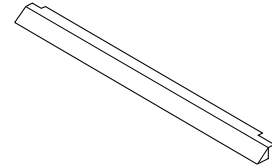

| Hood Kits | | |
|-----------|-----------------------|-------------------|
| Model No. | Catalog No. Model No. | |
| | Polished Brass | Brushed Stainless |
| EDV3530 | 96K67 EB35PB | 88L49 EB35BS |
| | 96K68 EB40PB | 88L50 EB40BS |
| EDV4540 | 96K69 EB45PB | 88L51 EB45BS |

These hood kits replace the standard hood that comes with these fireplaces.

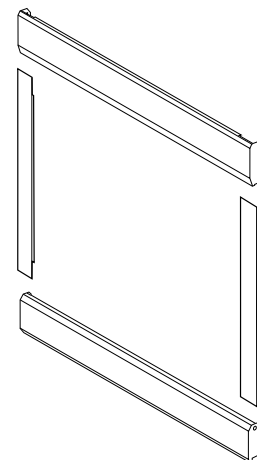

| 4-Piece Door Frame Kits | | |
|-------------------------|-----------------------|-------------------|
| Model No. | Catalog No. Model No. | |
| | Polished Brass | Brushed Stainless |
| EDV3530 | 88L44 DTKE35PB | 90L70 DTKE35BS |
| | 88L45 DTK40PB-2 | 90L71 DTK40BS |
| EDV4540 | 88L46 DTK45PB-2 | 90L72 DTK45BS |

These kits are designed to attach directly to the front face of the fireplace at the four edges of the glass enclosure panel.

ACCESSORY COMPONENTS CONTINUED

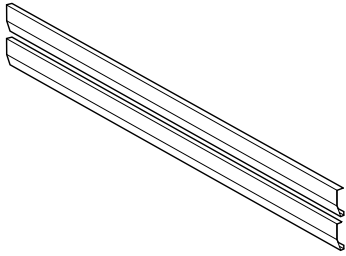

| 2-Piece Louver Kits | | |
|---------------------|-----------------------|-------------------|
| Model No. | Catalog No. Model No. | |
| | Polished Brass | Brushed Stainless |
| EDV3530 | 96L05 | 96L09 |
| | 2LVR35PB | 2LVR35BS |
| EDV4035 | 96L06 | 96L10 |
| | 2LVR40PB | 2LVR40BS |
| EDV4540 | 96L07 | 96L11 |
| | 2LVR45PB | 2LVR45BS |

The 2-piece polished brass or brushed stainless louver kits may be used to replace either the middle charcoal louver of each louver set, or the charcoal louver in each louver set closest to the glass door.

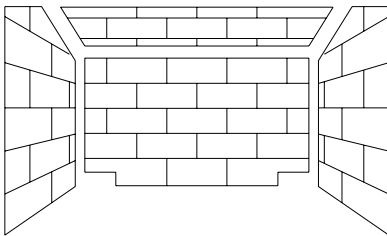

| Brickaded Panel Liner Kits | |
|----------------------------|-----------------------|
| Model No. | Catalog No. Model No. |
| EDV3530 | H0775 EBLK-35 |
| | H0776 EBLK-40 |
| EDV4540 | H0777 EBLK-45 |

The brickaded panel liner kits include ceramic panels of the side walls, the rear and the baffle of the firebox. The panels have brick-like features in relief.

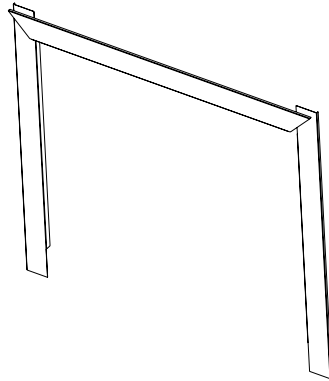

| Finish Trim Kits | |
|------------------|-----------------------|
| Model No. | Catalog No. Model No. |
| | Polished Brass |
| EDV3530 | H0454 TK35EPB3 |
| | 96K22 TK40PB3 |
| EDV4035 | 96K23 TK45PB3 |

This kit contains brass trim pieces used to finish the gaps between the wall board and the fireplace, providing the appliance a brass perimeter highlight.



Bag of Glowing Embers 88L53 FGE

Bag of Glowing Embers

Replacement ember materials are available for use with these appliances. Order a bag of Glowing Embers, Model FGE to replace ember materials as part of the periodic maintenance of the appliance.



Touch-Up Paint (Black) Kit 90L73 TPK-B

Touch-Up Paint Kit

Repair of minor scratches and discoloration of the appliance painted surfaces may be accomplished with the touch-up paint kit.

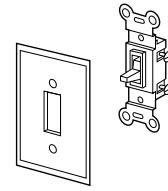

ON/OFF Wall Switch Kit 85L87 FWSK

ON/OFF Wall Switch Kit

The ON/OFF wall switch kit may be used to control the operation of the fireplace burner as an alternative to the modesty panel mounted ON-OFF switch. Install the ON/OFF wall switch in a convenient location near the fireplace.

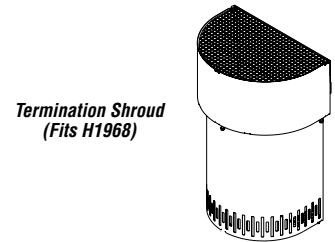

Termination Shroud (Fits H1968)

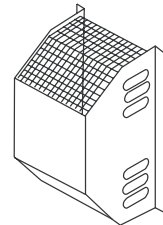

Deluxe Termination Guard (Fits 94L10)

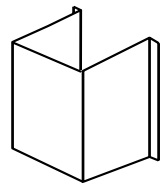

Square Termination Guard (Fits 94L10)

Termination Guard Kits

The vent termination guards may be used to cover the vent termination on the exterior of the home to minimize exposure to the hot surface of the termination.

| Termination Guard Kits (all models) | | |
|-------------------------------------|------------|---------------------------|
| Cat. No. | Model No. | Description |
| H5820 | 4.5HTSK | Termination Shroud |
| 87L02 | SV4.5HGS | Termination Guard, Deluxe |
| 17M52 | SV4.5HGS-1 | Termination Guard, Square |

ACCESSORY COMPONENTS CONTINUED

Style View Doors -

Style View Doors come in 4 beautiful styles. They are easy to install and will not require hardware to attach them to the standard glass door frame. The door includes heavy duty magnet door latches and functional twin-pane doors.

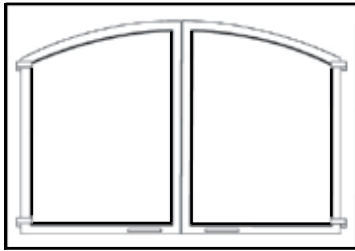

Arch Design

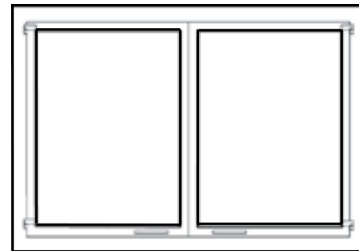

Square Design

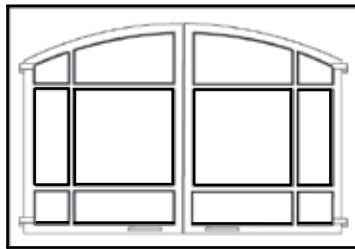

Arch Pane Design

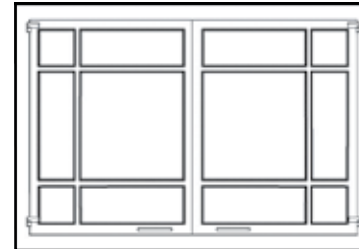

Square Pane Design

| ARCH DESIGN KITS | | | |
|-----------------------|----------|--|--------------|
| Cat. No. | Model | Description | Model Series |
| H0862 | AD40C | 40" Arch Doors, Black | EDV4035 |
| H0863 | AD40TI | 40" Arch Doors, Textured Iron | |
| H0864 | AD40SP | 40" Arch Doors, Satin Pewter | |
| H0865 | AD40AB | 40" Arch Doors, Antique Brass | |
| H0866 | AD45C | 45" Arch Doors, Black | |
| H0867 | AD45TI | 45" Arch Doors, Textured Iron | |
| H0868 | AD45SP | 45" Arch Doors, Satin Pewter | |
| H0869 | AD45AB | 45" Arch Doors, Antique Brass | |
| H0870 | AD35EC | 35" Elite Arch Doors, Black | EDV3530 |
| H0871 | AD35ETI | 35" Elite Arch Doors, Textured Iron | |
| H0872 | AD35ESP | 35" Elite Arch Doors, Satin Pewter | |
| H0873 | AD35EAB | 35" Elite Arch Doors, Antique Brass | |
| ARCH PANE DESIGN KITS | | | |
| H0934 | APD40C | 40" Arch Pane Doors, Black | EDV4035 |
| H0935 | APD40TI | 40" Arch Pane Doors, Textured Iron | |
| H0936 | APD40SP | 40" Arch Pane Doors, Satin Pewter | |
| H0937 | APD40AB | 40" Arch Pane Doors, Antique Brass | |
| H0938 | APD45C | 45" Arch Pane Doors, Black | EDV4540 |
| H0939 | APD45TI | 45" Arch Pane Doors, Textured Iron | |
| H0940 | APD45SP | 45" Arch Pane Doors, Satin Pewter | |
| H0941 | APD45AB | 45" Arch Pane Doors, Antique Brass | |
| H0942 | APD35EC | 35" Elite Arch Pane Doors, Black | |
| H0943 | APD35ETI | 35" Elite Arch Pane Doors, Textured Iron | |
| H0944 | APD35ESP | 35" Elite Arch Pane Doors, Satin Pewter | |
| H0945 | APD35EAB | 35" Elite Arch Pane Doors, Antique Brass | |

| SQUARE DESIGN KITS | | | |
|-------------------------|----------|---|--------------|
| Cat. No. | Model | Description | Model Series |
| H0950 | SD40C | 40" Sq. Doors, Black | EDV4035 |
| H0951 | SD40TI | 40" Sq. Doors, Textured Iron | |
| H0952 | SD40SP | 40" Sq. Doors, Satin Pewter | |
| H0953 | SD40AB | 40" Sq. Doors, Antique Brass | |
| H0954 | SD45C | 45" Sq. Doors, Black | |
| H0955 | SD45TI | 45" Sq. Doors, Textured Iron | |
| H0956 | SD45SP | 45" Sq. Doors, Satin Pewter | |
| H0957 | SD45AB | 45" Sq. Doors, Antique Brass | |
| H0958 | SD35EC | 35" Elite Sq. Doors, Black | EDV3530 |
| H0959 | SD35ETI | 35" Elite Sq. Doors, Textured Iron | |
| H0960 | SD35ESP | 35" Elite Sq. Doors, Satin Pewter | |
| H0961 | SD35EAB | 35" Elite Sq. Doors, Antique Brass | |
| SQUARE PANE DESIGN KITS | | | |
| H0966 | SPD40C | 40" Sq. Pane Doors, Black | EDV4035 |
| H0967 | SPD40TI | 40" Sq. Pane Doors, Textured Iron | |
| H0968 | SPD40SP | 40" Sq. Pane Doors, Satin Pewter | |
| H0969 | SPD40AB | 40" Sq. Pane Doors, Antique Brass | |
| H0970 | SPD45C | 45" Sq. Pane Doors, Black | EDV4540 |
| H0971 | SPD45TI | 45" Sq. Pane Doors, Textured Iron | |
| H0972 | SPD45SP | 45" Sq. Pane Doors, Satin Pewter | |
| H0973 | SPD45AB | 45" Sq. Pane Doors, Antique Brass | |
| H0974 | SPD35EC | 35" Elite Sq. Pane Doors, Black | |
| H0975 | SPD35ETI | 35" Elite Sq. Pane Doors, Textured Iron | |
| H0976 | SPD35ESP | 35" Elite Sq. Pane Doors, Satin Pewt. | |
| H0977 | SPD35EAB | 35" Elite Sq. Pane Doors, Ant. Brass | |

ACCESSORY COMPONENTS CONTINUED

Style View Doors Continued -

Style View Doors also come in a Tall Arch Pane Design. Two distinctive grille kits, the “Crescents” and “Sunrise” design, are also offered separately. They are easy to install and will not require hardware to attach them to the standard glass door frame. The door includes heavy duty magnet door latches and functional twin-pane doors.

Tall Arch Pane Door

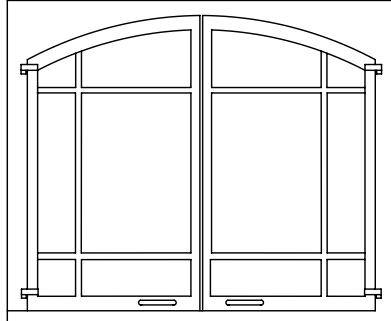

| TALL ARCH PANE DOORS | | | |
|----------------------|-----------|---|--------------|
| Cat. No. | Model | Description | Model Series |
| H3537 | TAPD35EC | 35" Elite Arch Pane Doors, Black | EDV3530 |
| H3539 | TAPD35ESP | 35" Elite Arch Pane Doors, Satin Pewter | |
| H3529 | TAPD40C | 40" Arch Pane Doors, Black | EDV4035 |
| H3531 | TAPD40SP | 40" Arch Pane Doors, Satin Pewter | |
| H3533 | TAPD45C | 45" Arch Pane Doors, Black | EDV4540 |
| H3535 | TAPD45SP | 45" Arch Pane Doors, Satin Pewter | |

Crescents Grille Kits

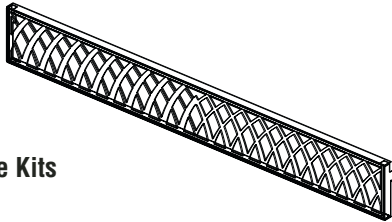

Sunrise Grille Kits

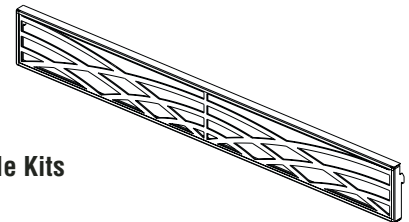

| “Crescents” Grille Kits | | | |
|-------------------------|----------|--|--------------|
| Cat. No. | Model | Description | Model Series |
| H3541 | CUGK35C | 35" Crescents Upper Grille Kit, Black | EDV3530 |
| H3543 | CUGK35SP | 35" Crescents Upper Grille Kit, Satin Pewter | |
| H3545 | CLGK35C | 35" Crescents Lower Grille Kit, Black | |
| H3547 | CLGK35SP | 35" Crescents Lower Grille Kit, Satin Pewter | |
| H3549 | CUGK40C | 40" Crescents Upper Grille Kit, Black | EDV4035 |
| H3551 | CUGK40SP | 40" Crescents Upper Grille Kit, Satin Pewter | |
| H3553 | CLGK40C | 40" Crescents Lower Grille Kit, Black | |
| H3555 | CLGK40SP | 40" Crescents Lower Grille Kit, Satin Pewter | |
| H3557 | CUGK45C | 45" Crescents Upper Grille Kit, Black | EDV4540 |
| H3559 | CUGK45SP | 45" Crescents Upper Grille Kit, Satin Pewter | |
| H3561 | CLGK45C | 45" Crescents Lower Grille Kit, Black | |
| H3563 | CLGK45SP | 45" Crescents Lower Grille Kit, Satin Pewter | |

| “Sunrise” Grille Kits | | | |
|-----------------------|----------|--|--------------|
| Cat. No. | Model | Description | Model Series |
| H3565 | SUGK35C | 35" Sunrise Upper Grille Kit, Black | EDV3530 |
| H3567 | SUGK35SP | 35" Sunrise Upper Grille Kit, Satin Pewter | |
| H3569 | SLGK35C | 35" Sunrise Lower Grille Kit, Black | |
| H3571 | SLGK35SP | 35" Sunrise Lower Grille Kit, Satin Pewter | |
| H3573 | SUGK40C | 40" Sunrise Upper Grille Kit, Black | EDV4035 |
| H3575 | SUGK40SP | 40" Sunrise Upper Grille Kit, Satin Pewter | |
| H3577 | SLGK40C | 40" Sunrise Lower Grille Kit, Black | |
| H3579 | SLGK40SP | 40" Sunrise Lower Grille Kit, Satin Pewter | |
| H3581 | SUGK45C | 45" Sunrise Upper Grille Kit, Black | EDV4540 |
| H3583 | SUGK45SP | 45" Sunrise Upper Grille Kit, Satin Pewter | |
| H3585 | SLGK45C | 45" Sunrise Lower Grille Kit, Black | |
| H3587 | SLGK45SP | 45" Sunrise Lower Grille Kit, Satin Pewter | |

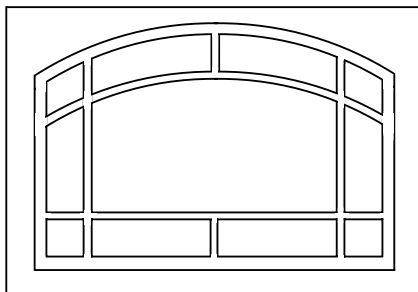

Arch Screen Panel Kit
40" Decorative Arch Screen Panel Kit - Textured Iron

Model No.
DASPK40TI

Catalog No.
H3594

This screen panel kit can be installed on the glass enclosure panel to prevent direct contact with the hot glass surface. The panel kit adds a new design choice with a handsome textured iron finish. The screen panel kit cannot be used in conjunction with either of the arch door kits or door frame kits.

Maintenance Schedule

Annually (Before the onset of the Burning Season)

| Maintenance Task | Accomplishing Person | Procedure |
|---|---|---|
| Inspecting/Cleaning Burner, Logs and Controls | Qualified Service Technician | Inspect valve and ensure it is properly operating. Check piping for leaks. Vacuum the control compartment, fireplace logs and burner area. |
| Check Flame Patterns and Flame Height | Qualified Service Technician | Refer to Figures 9 (EDV3530), 10 (EDV4035) or 11 (EDV4540) on page 15 and verify the flame pattern and height displayed by the appliance conforms to the picture. Flames must not impinge on the logs. |
| Inspecting/Cleaning Pilot and Burner | Qualified Service Technician | Refer to Figure 13 (SIT) or Figure 14 (Honeywell) on page 16 . Remove any surface build-up on pilot and burner assembly. Wipe the pilot nozzles, ignitor/flame rod and hood. Ensure the pilot flame engulfs the flame sensor as shown. |
| Checking Vent System | Qualified Service Technician | Inspect the vent system at the top and at the base (within the firebox) for signs of blockage or obstruction. Look for any signs of dislocation of the vent components. |
| Appliance Checkout | Qualified Service Technician | Perform the appropriate appliance checkout procedure detailed in this manual. |
| Replacing Rockwool Ember Materials | Homeowner/Qualified Services Technician | Remove old ember materials and vacuum the rockwool placement area. Place new rockwool as described in this document. |

Periodically (After the Burning Season)

| Maintenance Task | Accomplishing Person | Procedure |
|---------------------------------------|----------------------|---|
| Cleaning Firebox Interior | Homeowner | Carefully remove logs, rockwool and decorative volcanic stone and vermiculite. Vacuum out interior of the firebox. Clean firebox walls and log grate. Replace logs, Rockwool and volcanic stone as detailed in this manual. |
| Check Flame Patterns and Flame Height | Homeowner | Refer to Refer to Figures 9 (EDV3530), 10 (EDV4035) or 11 (EDV4540) on page 15 and verify the flame pattern and height displayed by the appliance conforms to the picture. Flames must not impinge on the logs. |
| Checking Vent System | Homeowner | Inspect the vent system at the top and at the base (within the firebox) for signs of blockage or obstruction. Look for any signs of dislocation of the vent components. |
| Cleaning Front Glass Enclosure Panel | Homeowner | Clean as necessary following the directions provided in this manual. DO NOT TOUCH OR ATTEMPT TO CLEAN GLASS WHILE HOT. |



LIGHTING INSTRUCTIONS – MILLIVOLT GAS VALVE

FOR YOUR SAFETY READ BEFORE LIGHTING

WARNING: IF YOU DO NOT FOLLOW THESE INSTRUCTIONS EXACTLY, A FIRE OR EXPLOSION MAY RESULT CAUSING PROPERTY DAMAGE, PERSONAL INJURY OR LOSS OF LIFE.

- A.** This appliance has a pilot which must be lighted with a piezo ignitor. When lighting the pilot, follow these instructions exactly.
- B. BEFORE OPERATING** smell all around the appliance area for gas. Be sure to smell next to the floor because some gas is heavier than air and will settle on the floor.
- WHAT TO DO IF YOU SMELL GAS**
- Extinguish any open flame.
 - Open windows.
 - Do not light any appliance.
 - Do not touch any electrical switches.
 - Do not use any phone in your building.
 - Immediately call your gas supplier from a neighbor's phone.
 - If your gas supplier cannot be reached, call the fire department.
- C.** Use only your hand to push in or turn the gas control knob. Never use tools. If the knob will not push in or turn by hand, do not try to repair it, call a qualified service technician. Force or attempted repair may result in a fire or an explosion.
- D.** Do not use this appliance if any part has been under water. Immediately call a qualified service technician to inspect the appliance and to replace any part of the control system and any gas control which has been under water.

LIGHTING INSTRUCTIONS

1. **STOP!** Read the safety information above on this page.
2. Access the lower control compartment.
3. Turn remote wall switch to "OFF."
4. Verify main line shut-off valve is open.
5. Push in gas control knob slightly and turn clockwise to "OFF."

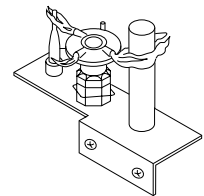
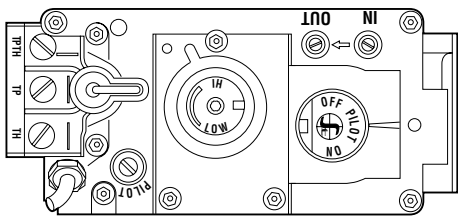
6. Wait five (5) minutes to clear out any gas. If you then smell gas, STOP! Follow "B" in the safety information above on this page. If you do not smell gas, go to the next step.
7. Push in gas control knob slightly and turn counterclockwise to "PILOT."

8. Push in control knob all the way and hold in. Immediately light the pilot by triggering the spark ignitor (pushing the button) until pilot lights. Continue to hold the control knob in for about 1 1/2 minutes after the pilot is lit. Release knob and it will pop back up. Pilot should remain lit. If it goes out, repeat steps 5 through 8.
 - If knob does not pop up when released, stop and immediately call your service technician or gas supplier.
 - If pilot will not stay lit after several tries, turn the control knob to "OFF" and call your service technician or gas supplier.
9. Turn gas control knob counterclockwise to "ON."

10. Close lower control compartment.



Note: Knob cannot be turned from "PILOT" to "OFF" unless the knob is pushed in slightly. Do not force.

TO TURN OFF GAS TO APPLIANCE

1. Turn remote wall switch "OFF." The pilot will remain lit for normal service.
2. For complete shutdown, turn remote wall switch to "OFF."
3. Access the lower control compartment.
4. Depress gas control knob slightly and turn clockwise to "OFF." Do not force.

5. Close lower control compartment.

INSTRUCTIONS D'ALLUMAGE – VANNE GAZ MILLIVOLT

POUR VOTRE SÉCURITÉ, LISEZ CES INSTRUCTIONS AVANT L'ALLUMAGE

AVERTISSEMENT : SI VOUS NE SUIVEZ PAS CES INSTRUCTIONS À LA LETTRE, IL POURRAIT S'EN SUIVRE UN INCENDIE OU UNE EXPLOSION CAUSANT DES DOMMAGES MATÉRIELS, DES BLESSURES CORPORELLES OU MÊME DES PERTES DE VIE.

- A.** Cet appareil est muni d'une veilleuse qui doit être allumée avec un allumeur piézo-électrique. Lorsque vous allumez la veilleuse, suivre exactement ces instructions.
- B. AVANT L'ALLUMAGE:** Assurez-vous que vous ne détectez aucune odeur de gaz autour de l'appareil ainsi que près du sol; certains gaz, étant plus lourds que l'air, descendent au niveau du sol.
VOICI CE QUE VOUS DEVEZ FAIRE SI VOUS DÉCELEZ UNE ODEUR DE GAZ:
- Éteignez toute flamme visible.
 - Ouvrez les fenêtres.
 - N'allumez aucun appareil.
 - Ne touchez à aucun commutateur électrique.
 - Ne vous servez d'aucun téléphone dans votre édifice.
- C.** Appelez immédiatement votre compagnie de gaz en utilisant le téléphone du voisin.
- D.** S'il vous est impossible de contacter votre compagnie de gaz, appelez le service des incendies.
- C.** N'utilisez que votre main pour manipuler le bouton de réglage du gaz. N'utilisez jamais d'outils. Si le bouton refuse de tourner ou de bouger, n'essayez pas de le réparer. Communiquez immédiatement avec un technicien de service qualifié. Toute tentative pour le forcer ou le réparer, risquerait de provoquer un incendie ou une explosion.
- D.** Ne vous servez pas de cet appareil si l'un de ses éléments a été immergé dans l'eau. Appelez immédiatement un technicien compétent pour faire inspecter l'appareil et remplacer toute pièce du système de réglage ou commande du gaz qui a été sous l'eau.

INSTRUCTIONS D'ALLUMAGE

- 1. ARRÊTEZ!** Lisez les consignes de sécurité au verso de cette plaque.
- Ouvrez le compartiment de contrôle du bas.
- Tournez l'interrupteur mural à la position d'arrêt "OFF".
- Assurez-vous que la soupape d'arrêt de la canalisation principale est ouverte.
- Enfoncez légèrement le bouton de réglage du gaz et tournez-le dans le sens des aiguilles d'une montre jusqu'à la position d'arrêt "OFF".

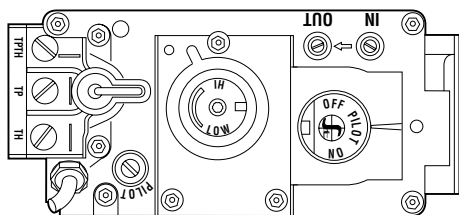

Remarque: Il est impossible de tourner le bouton de "PILOT" à "OFF" à moins qu'il ne soit légèrement enfoncé. Ne le forcez pas.

- 6.** Attendez cinq (5) minutes pour l'évacuation du gaz. Si vous décelez une odeur de gaz, ARRÊTEZ ! Retournez au point "B" des consignes de sécurité au verso de cette plaque. Si vous ne remarquez aucune odeur de gaz, passez à l'étape suivante.
- 7.** Enfoncez légèrement le bouton de réglage du gaz et tournez-le en sens inverse des aiguilles d'une montre jusqu'à la position de veilleuse "PILOT".

- 8.** Enfoncez le bouton de réglage jusqu'au fond et gardez-le enfoncé. Allumez immédiatement la veilleuse en déclenchant l'allume-gaz à étincelle (en poussant le bouton) jusqu'à ce que la veilleuse s'enflamme. Continuez de tenir le bouton de réglage enfoncé pendant environ 90 secondes après l'allumage de la veilleuse. Relâchez le bouton et il sortira subitement. La veilleuse devrait rester allumée. Si elle s'éteint, répétez les étapes 5 à 8 inclusivement.

• Si le bouton ne sort pas automatiquement après avoir été relâché, arrêtez immédiatement et téléphonez à votre technicien de service ou à votre fournisseur de gaz.

• Si la veilleuse refuse de rester allumée après plusieurs tentatives, tournez le bouton de réglage jusqu'à sa position d'arrêt "OFF" et téléphonez à votre technicien de service ou à votre fournisseur de gaz.

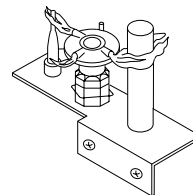

- 9.** Tournez le bouton de réglage du gaz en sens inverse des aiguilles d'une montre jusqu'à sa position de marche "ON".
- 10.** Fermez le compartiment de contrôle du bas.
- 11.** Au besoin, rebrancher l'appareil au courant électrique et remettre l'interrupteur du brûleur principal à la position "ON" ou régler le thermostat à la température désirée.
- 12.** Si l'appareil ne fonctionne pas, suivre les instructions intitulées "Pour fermer le gaz qui alimente l'appareil" et appeler un technicien ou le fournisseur de gaz.

POUR FERMER LE GAZ QUI ALIMENTE L'APPAREIL

- 1.** Tournez l'interrupteur mural à la position d'arrêt "OFF". La veilleuse restera allumée jusqu'au retour du service normal.
- 2.** Pour une fermeture complète, tournez l'interrupteur mural à la position d'arrêt "OFF".
- 3.** Ouvrez le compartiment de contrôle du bas.
- 4.** Enfoncez légèrement le bouton de réglage du gaz et tournez-le dans le sens des aiguilles d'une montre jusqu'à la position d'arrêt "OFF". Ne forcez pas le bouton.
- 5.** Fermez le compartiment de contrôle du bas.

LIGHTING INSTRUCTIONS — ELECTRONIC

FOR YOUR SAFETY READ BEFORE LIGHTING

WARNING: IF YOU DO NOT FOLLOW THESE INSTRUCTIONS EXACTLY, A FIRE OR EXPLOSION MAY RESULT CAUSING PROPERTY DAMAGE, PERSONAL INJURY OR LOSS OF LIFE.

- A.** When lighting the appliance, follow these instructions exactly.
- B. BEFORE OPERATING** smell all around the appliance area for gas. Be sure to smell next to the floor because some gas is heavier than air and will settle on the floor.
- WHAT TO DO IF YOU SMELL GAS**
- Extinguish any open flame.
 - Open windows.
 - Do not light any appliance.
 - Do not touch any electrical switches.
 - Do not use any phone in your building.
- Immediately call your gas supplier from a neighbor's phone.
 - If your gas supplier cannot be reached, call the fire department.
- C.** Use only your hand to turn the gas control lever. Never use tools. If the lever will not turn by hand, do not try to repair it, call a qualified service technician. Force or attempted repair may result in a fire or an explosion.
- D.** Do not use this appliance if any part has been under water. Immediately call a qualified service technician to inspect the appliance and to replace any part of the control system and any gas control which has been under water.

LIGHTING INSTRUCTIONS

1. **STOP!** Read the safety information above on this page.
2. Turn remote wall switch to "OFF."
3. Open lower control compartment door.
4. Verify main line shut-off valve is open.
5. Turn the ON/OFF switch to "OFF". Do not force.
6. Wait five (5) minutes to clear out any gas. If you then smell gas, STOP! Follow "B" in the safety information above on this page. If you do not smell gas, go to the next step.
7. Turn the ON/OFF switch to "ON". Do not force.
8. Turn "ON" all electrical power to appliance (remote wall switch).
9. Close lower control compartment door.

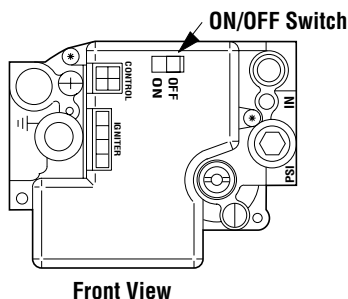

TO SHUT OFF

1. Turn off all electrical power to the appliance (remote wall switch).

TO TURN OFF GAS TO APPLIANCE

1. For complete shut-down, turn remote wall switch to "OFF."
2. Open lower control compartment door.
3. Turn the ON/OFF switch to "OFF". Do not force.
4. Close the main line shut-off valve.
5. Close lower control compartment door.

INSTRUCTIONS D'ALLUMAGE — ELECTRONIC

POUR VOTRE SÉCURITÉ, LISEZ CES INSTRUCTIONS AVANT L'ALLUMAGE

AVERTISSEMENT: SI VOUS NE SUIVEZ PAS CES INSTRUCTIONS À LA LETTRE, IL POURRAIT S'EN SUIVRE UN INCENDIE OU UNE EXPLOSION CAUSANT DES DOMMAGES MATÉRIELS, DES BLESSURES CORPORELLES OU MÊME DES PERTES DE VIE.

- A.** Lorsque vous allumez l'appareil, suivez exactement ces instructions.
- B. AVANT L'ALLUMAGE:** Assurez-vous que vous ne détectez aucune odeur de gaz autour de l'appareil ainsi que près du sol; certains gaz, étant plus lourds que l'air, descendent au niveau du sol.
- VOICI CE QUE VOUS DEVEZ FAIRE SI VOUS DÉCELEZ UNE ODEUR DE GAZ**
- Éteignez toute flamme visible.
 - Ouvrez les fenêtres.
 - N'allumez aucun appareil.
 - Ne touchez à aucun commutateur électrique.
 - Ne vous servez d'aucun téléphone dans votre édifice.
- Appelez immédiatement votre compagnie de gaz en utilisant le téléphone du voisin.
 - S'il vous est impossible de contacter votre compagnie de gaz, appelez le service des incendies.
- C.** N'utilisez que votre main pour manipuler l'interrupteur "ON/OFF" de la valve à gaz. N'utilisez jamais d'outils. Si l'interrupteur ne bouge pas manuellement, n'essayez pas de le réparer. Communiquez immédiatement avec un technicien de service qualifié. Toute tentative pour forcer l'interrupteur ou le réparer, risquerait de provoquer un incendie ou une explosion.
- D.** Ne vous servez pas de cet appareil si l'un de ses éléments a été immergé dans l'eau. Appelez immédiatement un technicien compétent pour faire inspecter l'appareil et remplacer toute pièce du système de réglage ou commande du gaz qui a été sous l'eau.

INSTRUCTIONS D'ALLUMAGE

- 1. ARRÊTEZ !** Lisez les consignes de sécurité au verso de cette plaque.
2. Tournez l'interrupteur mural à la position d'arrêt "OFF".
3. Ouvrez la porte du compartiment de contrôle du bas.
4. Assurez-vous que la soupape d'arrêt de la canalisation principale est ouverte.
5. Tournez la manette de réglage du gaz à la position d'arrêt "OFF".
6. Attendez cinq (5) minutes pour l'évacuation du gaz. Si vous décelez une odeur de gaz **ARRÊTEZ !** Retournez au point "B" des consignes de sécurité au verso de cette plaque. Si vous ne remarquez aucune odeur de gaz, passez à l'étape suivante.
7. Tournez la manette de réglage du gaz jusqu'à la position de marche "ON". Ne la forcez pas.
8. Ouvrez le courant électrique ("ON") qui alimente l'appareil (interrupteur mural).
9. Fermez la porte du compartiment de contrôle du bas.
10. Au besoin, rebranchez l'appareil au courant électrique et remettez l'interrupteur principal du brûleur à la position "ON" ou réglez le thermostat à la température désirée.
11. Si l'appareil ne se met pas en marche, suivre les instructions intitulées "Pour fermer le gaz qui alimente l'appareil" et appeler un technicien ou le fournisseur de gaz.

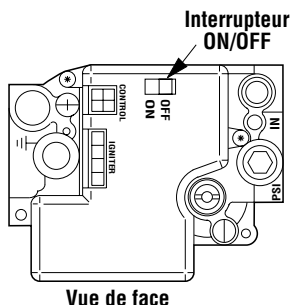

Vue de face

POUR ÉTEINDRE L'APPAREIL

1. Coupez tout le courant électrique qui alimente l'appareil (interrupteur mural).

POUR FERMER LE GAZ QUI ALIMENTE L'APPAREIL

1. Pour une fermeture complète, tournez l'interrupteur mural à la position d'arrêt "OFF".
2. Ouvrez la porte du compartiment de contrôle du bas.
3. Tournez la manette de réglage du gaz à la position d'arrêt "OFF". Ne la forcez pas.
4. Fermez la soupape d'arrêt de la canalisation principale.
5. Fermez la porte du compartiment de contrôle du bas.

TROUBLESHOOTING THE MILLIVOLT GAS CONTROL SYSTEM

Note: Before troubleshooting the gas control system, be sure external gas shut off valve (located at gas supply inlet) is in the “ON” position.

Important: Valve system troubleshooting should only be accomplished by a qualified service technician.

| SYMPTOM | POSSIBLE CAUSES | CORRECTIVE ACTION |
|--|--|---|
| 1. Spark ignitor will not light pilot after repeated triggering of ignitor button. | A. Defective ignitor (no spark at electrode). | Check for spark at electrode and pilot; if no spark and electrode wire is properly connected, replace ignitor. |
| | B. Defective or misaligned electrode at pilot (spark at electrode). | Using a match, light pilot. If pilot lights, turn off pilot and trigger the ignitor button again. If pilot lights, an improper gas mixture caused the bad lighting and a longer purge period is recommended. If pilot will not light – check gap at electrode and pilot – should be 1/8" to have a strong spark. If gap measures 1/8", replace pilot (Figure 13 on page 10). |
| | C. Gas supply pressure errant. | Check inlet gas pressure. It should be within the limits as marked on the rating plate. |
| | D. Pilot orifice plugged. | Clean or replace pilot orifice. |
| 2. Pilot will not stay lit after carefully following the lighting instructions. | A. Defective pilot generator (thermocouple). | Check pilot flame, it must impinge on thermocouple (Figure 13 on page 10) Clean and/or adjust pilot for maximum flame impingement on thermocouple. Ensure that the connection between the valve and thermocouple are tight and secure. |
| 3. Pilot burning, no gas to burner, Valve knob “ON,” Wall Switch “ON.” | A. Wall switch or wires defective. | Check wall switch and wires for proper connections. Jumper wire across terminals at wall switch, if burner comes on, replace defective wall switch. If okay, jumper wires across wall switch wires at valve, if burner comes on, wires are faulty or connections are bad. |
| | B. Thermopile may not be generating sufficient millivoltage. | Check thermopile with millivolt meter. Take reading at thermopile terminals of gas valve. Should read 325 millivolts minimum with optional wall switch “OFF.” Replace faulty thermopile if reading is below specified minimum. |
| | C. Plugged burner orifice. | Check burner orifice for stoppage and remove. |
| 4. Frequent pilot/burner outage problem. | A. Pilot flame may be too low or blowing (high) causing the pilot/valve safety to drop out. | Clean and/or adjust pilot flame for maximum flame impingement on thermocouple (Figure 13 on page 10). |

TROUBLESHOOTING THE ELECTRONIC IGNITION SYSTEM

Note: Before troubleshooting, be sure that the appliance main line gas shut-off valve, the gas control valve and the wall switch are in the "ON" position.

Important: Valve system troubleshooting should only be accomplished by a qualified service technician.

| SYMPTOM | POSSIBLE CAUSES | CORRECTIVE ACTION |
|------------------------------------|---------------------------------------|--|
| 1. Burner will not light. | A. Faulty Valve System. | See Below. |
| | B. "OFF/ON" or wall switch defective. | Disconnect the two black wires from the wire nuts. Test switch(s) for continuity with a multimeter. If continuity is not indicated, switch(s) is defective and must be replaced. Note: Before replacing "OFF/ON" switch, be sure to check wiring for loose connections or broken wires and repair as needed. |
| 2. Burners come "ON" but go "OFF." | A. Burner orifice plugged. | Check main burner orifice(s) for stoppage. Clean or replace. |
| | B. Obstructed vent system. | Check vent system for obstructions. |

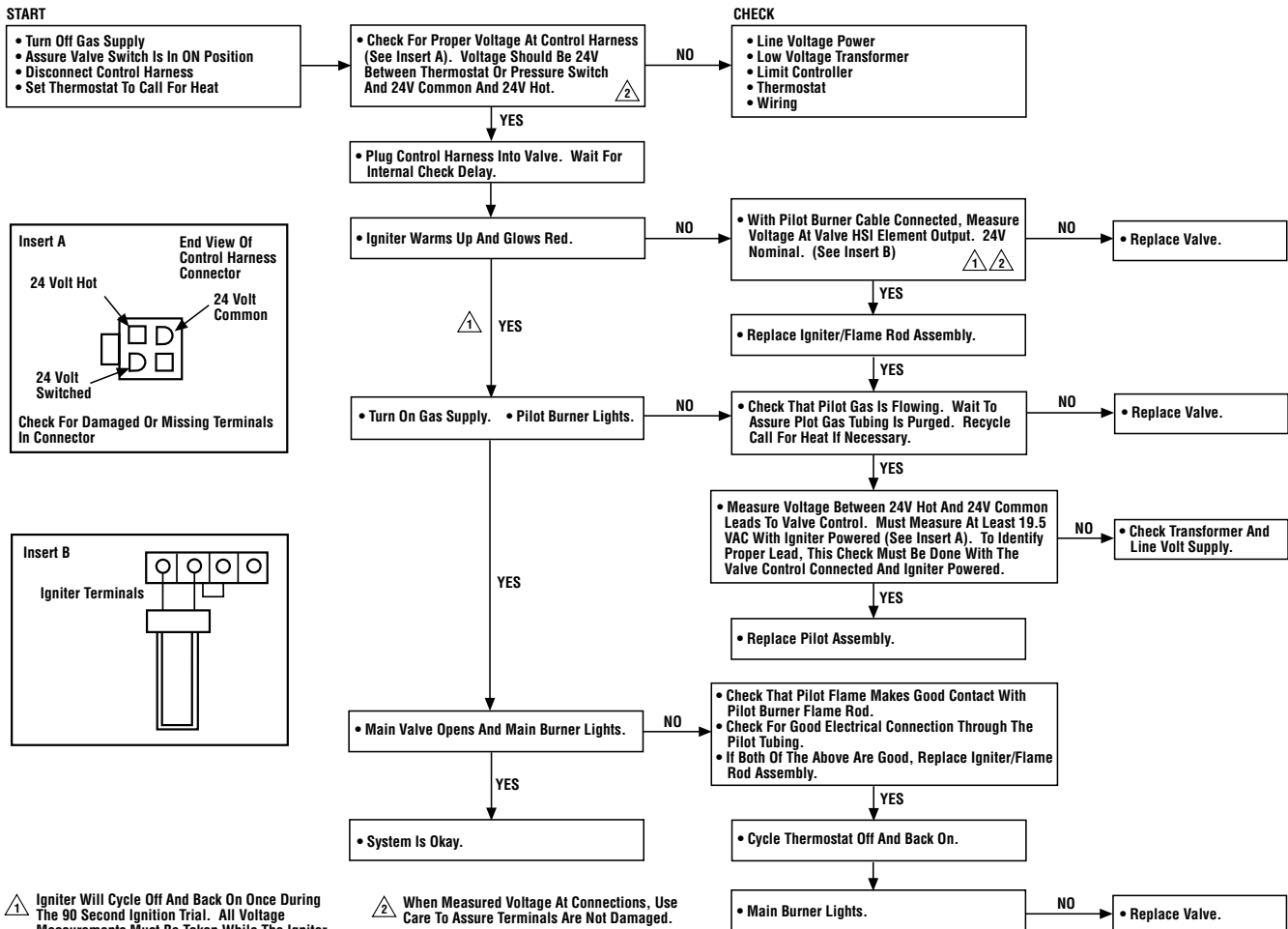

REPLACEMENT PARTS LIST

| Item No. | Description | EDV3530 | | EDV4035 | | EDV4540 | |
|----------|-----------------------------------|----------|------|----------|------|----------|------|
| | | Part No. | Qty. | Part No. | Qty. | Part No. | Qty. |
| 1 | Hood | H3895 | 1 | H3896 | 1 | H3897 | 1 |
| 2 | Louver Assembly, Top | H3726 | 1 | H2727 | 1 | H3728 | 1 |
| 3 | Louver Assembly, Bottom | H3726 | 1 | H2727 | 1 | H3728 | 1 |
| 4 | Enclosure, Glass Front (Complete) | 91L18 | 1 | H3724 | 1 | 91L16 | 1 |
| 5 | Bustle, Top | H4964 | 1 | H3741 | 1 | H3742 | 1 |
| 6 | Bustle, Bottom | 91L25 | 1 | H3729 | 1 | H3730 | 1 |
| 7 | Nameplate (Brand) | 12L15 | 1 | 12L15 | 1 | 12L15 | 1 |
| 8 | Latch | 69L21 | 2 | 69L21 | 2 | 69L21 | 2 |
| 9 | Catch, Door, Magnetic | 69L31 | 1 | 69L31 | 1 | 69L31 | 1 |
| 10 | Log Set (Complete) | 55M02 | 1 | 55M03 | 1 | 55M03 | 1 |
| 11 | Burner Assembly | 55M29 | 1 | 55M30 | 1 | 55M30 | 1 |
| 12 | Grate Assembly | H4990 | 1 | H4991 | 1 | H4991 | 1 |
| 13 | Venturi/Air Shutter | H3707 | 1 | H3707 | 1 | H3707 | 1 |
| 14 | Orifice, Main Burner - Nat. Gas | 69L96 | 1 | 18L40 | 1 | 99K77 | 1 |
| 14 | Orifice, Main Burner - LP Gas | 39L10 | 1 | 37G00 | 1 | H0922 | 1 |
| 15 | Ceramic Panel Floor (Complete) | 55M46 | 1 | 55M47 | 1 | 55M48 | 1 |
| 16 | Bag of Rockwool | 88L53 | 1 | 88L53 | 1 | 88L53 | 1 |
| 17 | ON/OFF Control Switch | 80L41 | 1 | 80L41 | 1 | 80L41 | 1 |
| 18a | Modesty Panel, Millivolt | H3382 | 1 | H3382 | 1 | H3384 | 1 |
| 18b | Modesty Panel, Electronic | H3381 | 1 | H3381 | 1 | H3383 | 1 |
| 19 | Gasket - Venturi Tube Mounting | 43K85 | 1 | 43K85 | 1 | 43K85 | 1 |
| 20 | Gas Line Flexible Connector | 93L32 | 1 | 93L32 | 1 | 93L32 | 1 |
| 21 | Magnet | H3699 | 1 | H3699 | 1 | H3699 | 1 |

Gas Controls - SIT Millivolt

| Item No. | Description | Natural Gas | | Propane Gas | |
|----------|---------------------|-------------|------|-------------|------|
| | | Part No. | Qty. | Part No. | Qty. |
| 30 | Gas Valve, SIT | 43K07 | 1 | 88J53 | 1 |
| 31 | Piezo Igniter | 10K86 | 1 | 10K86 | 1 |
| 32 | Pilot Assembly | 69L17 | 1 | 69L18 | 1 |
| 33 | Pilot Generator | 60J79 | 1 | 60J79 | 1 |
| 34 | Thermocouple | 74L57 | 1 | 74L57 | 1 |
| 35 | Pilot Tube | 74L56 | 1 | 74L56 | 1 |
| 36 | Electrode And Cable | 74L58 | 1 | 74L58 | 1 |

Gas Controls - Honeywell Electronic

| Item No. | Description | Natural Gas | |
|----------|------------------------|-------------|------|
| | | Part No. | Qty. |
| 40 | Gas Valve, Honeywell | 62L18 | 1 |
| 41 | Pilot Assembly | 62L14 | 1 |
| 42 | Transformer | 42J32 | 1 |
| 43 | Ignitor Assembly (Kit) | 87L54 | 1 |

Contact an Authorized Lennox Hearth Products dealer to obtain any of these parts. Never use substitute materials. Use of non-approved parts can result in poor performance and safety hazards.

WARNING

Failure to position the parts in accordance with these diagrams or failure to use only parts specifically approved with this appliance may result in property damage or personal injury.

AVERTISSEMENT

Risque de dommages ou de blessures si les pièces ne sont pas installées conformément à ces schémas et ou si des pièces autres que celles spécifiquement approuvées avec cet appareil sont utilisées.

REPLACEMENT PARTS

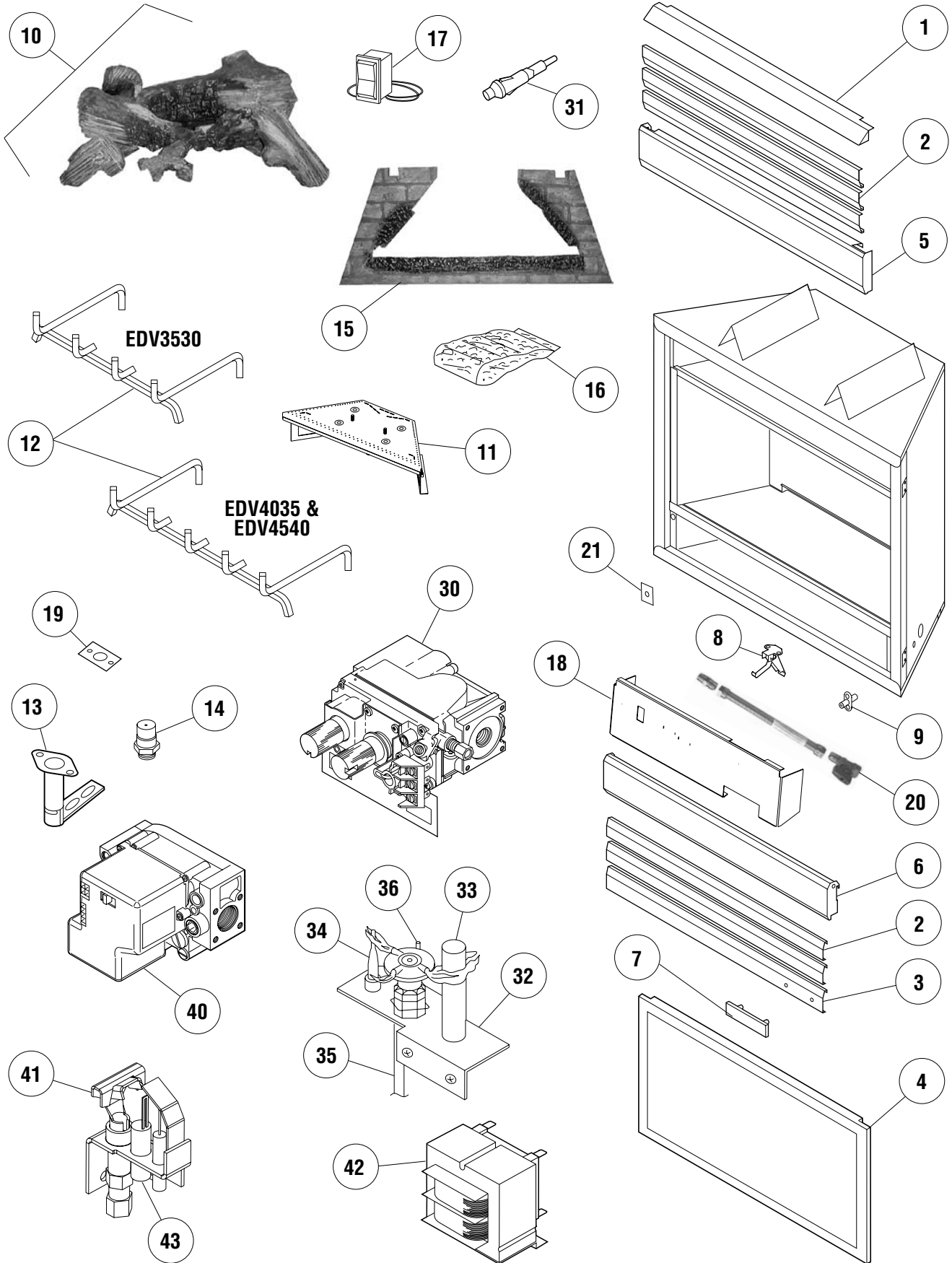

NOTE: DIAGRAMS & ILLUSTRATIONS ARE NOT TO SCALE.

Lennox Hearth Products reserves the right to make changes at any time, without notice, in design, materials, specifications, prices and also to discontinue colors, styles and products. Consult your local distributor for fireplace code information.



HEARTH PRODUCTS

Printed in U.S.A. © 2003 Lennox Hearth Products

P/N 875021M REV. K 01/2011

1508 Elm Hill Pike, Suite 108 • Nashville, TN 37210