

FS-A71

PICMG1.3 Full-size CPU Card User's Manual

Edition: 1.1

2008/06/12



Copyright

Copyright 2008. All rights reserved. This document is copyrighted and all rights are reserved. The information in this document is subject to change without prior notice to make improvements to the products.

This document contains proprietary information and protected by copyright. No part of this document may be reproduced, copied, or translated in any form or any means without prior written permission of the manufacturer.

All trademarks and/or registered trademarks contains in this document are property of their respective owners.

Disclaimer

The company shall not be liable for any incidental or consequential damages resulting from the performance or use of this product.

The company does not issue a warranty of any kind, express or implied, including without limitation implied warranties of merchantability or fitness for a particular purpose.

The company has the right to revise the manual or include changes in the specifications of the product described within it at any time without notice and without obligation to notify any person of such revision or changes.

Trademark

All trademarks are the property of their respective holders.

Any questions please visit our website at <http://www.commell.com.tw>.

Packing List

Please check package component before you use our products.

Hardware:

FS-A71 PICMG1.3 Full-Size CPU card x 1

Cable Kit:



Floppy flat cable x 1



PS/2 Keyboard & Mouse cable x 1



4-pin to 3-pin ATX cable x 1



SATA cable x 2

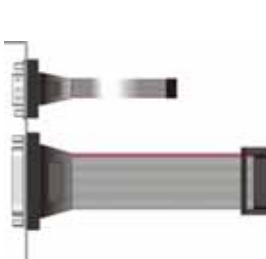

DB25 & DB9 cable x 1
(FS-A71G-Only)

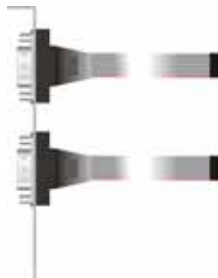

COM Port cable x 1
(FS-A71G2-Only)



ATA 100 x 1



Audio Port cable x 1

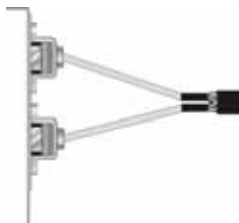

USB cable x 2



Printer cable x 1
(FS-A71G2-Only)



CPU Cooler x 1

Other Accessories:

Divers CD (Including User's Manual) x 1

Index

Chapter1 <Introduction>	6
1.1 <Product Overview>	6
1.2 <Product Specification>	7
1.3 <Block Diagram>	9
1.4 <Mechanical Drawing >	10
Chapter 2 <Hardware Setup>	11
2.1 <Connector Location>	11
2.3 <Connector Reference>	13
2.3.1 <Internal Connectors>	13
2.3.2 <External Connectors>	13
2.4 <CPU and Memory Setup>	14
2.4.1 <CPU installation>	14
2.4.2 <Memory installation>	15
2.5 <CMOS Setup>	16
2.6 <Enhanced IDE Interface>	17
2.7 <Serial ATA installation>	18
2.8 <LAN Interface>	19
2.9 <Onboard Display Interface>	20
2.9.1 <Analog Display>	20
2.9.2 <Digital Display>	20
2.9.3 <TV-out Interface>	24
2.10 <Audio Installation>	26
2.11 <GPIO interface>	28
2.12 <USB2.0 Interface>	29
2.12 <Power and Fan Installation>	30
2.13 <Serial Port>	31
2.14 <Switch and Indicator>	32

Chapter 3 <System Configuration>	34
3.1 <Audio Configuration>	34
3.2 <Video Memory Setup>	35
Chapter 4 <BIOS Setup>	36
Appendix A <I/O Port Pin Assignment>	38
A.1 <Serial ATA Port>.....	38
A.2 <IrDA Port>.....	38
A.3 <VGA Port>.....	38
A.4 <LAN Port>.....	39
A.5 <Floppy Port>.....	39
A.6 <Parallel Port>.....	40
Appedix B <System Resources>	41
Appedix C <Flash BIOS>	45
C.1 BIOS Auto Flash Tool	45
C.2 Flash Method.....	45
Appendix D <Programming GPIO's>	46
Appendix E <Watch Dog timer Setting >	47
Contact Information	48

(This page is left for blank)

Chapter1 <Introduction>

1.1 <Product Overview>

FS-A71 is the Full-size single board computer with last Intel technology with PICMG1.3 form factor. Based on Intel® GME965 and ICH8-M, the board integrates a new Core 2 Duo / Celeron M Mobile processor 478-pin socket, DDR2 memory socket, Intel® Graphic Media Accelerator X3100 technology, Serial ATA II for a powerful system.

Intel® Merom dual core Processor

The board supports Intel® Core 2 Duo **socket-P** processor with 533/667/800MHz front side bus, 4MB L2 cache, to provide more powerful performance than before.

New features for Intel GME965 chipset

The board integrates Intel® GME965 and ICH8-M chipset, to provide new generation of the mobile solution, supports Intel® GMA X3100 graphics, DDR2 533/667MHz memory, Supports Intel® Flex Memory Technology built-in high speed mass storage interface of serial ATA, High Definition Audio with 2 channels surrounding sound.

All in One multimedia solution

Based on Intel® GME965 and ICH8-M chipset, the board provides high performance onboard graphics, 18/24-bit Single/dual channel LVDS interface, HDTV and High Definition Audio, to meet the very requirement of the multimedia application.

Flexible Extension Interface

The board provides Compact Flash Type II slot, two mini-PCI slot.

1.2 <Product Specification>

General Specification

Form Factor	PICMG1.3 Full-size CPU Card
CPU	Support Intel® Core 2 Duo / Celeron M Mobile Processor Package type: Micro-FCPGA478 (Socket-P) Front side bus: 533/667/800 MHz
Memory	2 x 240-pin DDR2 533/667MHz SDRAM up to 3GB with dual channel Interleaved mode Unbuffered, non-ECC memory supported only
Chipset	Intel® GME965 (Northbridge) and ICH8M (82801HBM)(Southbridge)
BIOS	Phoenix-Award v6.00PG 8Mb SPI flash BIOS
Green Function	Power saving mode includes doze, standby and suspend modes. ACPI version 1.0 and APM version 1.2 compliant
Watchdog Timer	System reset programmable watchdog timer with 1 ~ 255 sec./min. of timeout value
Real Time Clock	Intel® ICH8-M built-in RTC with lithium battery
Serial ATAIL	Intel® ICH8-M integrates 3 Serial ATA II interface

Multi-I/O Port

Chipset	Intel® 82801HBM(ICH8-M) with Winbond® W83627DHG controller
Serial Port	One RS-232 and one RS232/422/485 serial ports
USB Port	Six Hi-Speed USB 2.0 ports with 480Mbps of transfer rate
Parallel Port	One internal bi-direction parallel port with SPP/ECP/EPP mode
Floppy Port	One internal Floppy port
IrDA Port	One IrDA compliant Infrared interface supports SIR
K/B & Mouse	External PS/2 keyboard and mouse port on bracket
GPIO	One 12-pin Digital I/O connector with 8-bit programmable I/O interface
Smart Fan	One CPU fan connector for fan speed controllable

VGA Display Interface

Chipset	Intel® GME965 GMA X3100 (Graphic Memory Controller Hub)
Display Type	CRT, LCD monitor with analog display, HDTV, LVDS
Frame Buffer	Up to 256MB shared with system memory
Connector	External DB15 female connector on bracket Onboard 40-Pin LVDS connector Onboard 9-Pin TV-out connector

Ethernet Interface

Controller	Intel® 82573L Gigabit Ethernet controller
Type	Triple speed 10/100/1000Base-T Auto-switching Fast Ethernet Full duplex, IEEE802.3U compliant
Connector	Two External RJ45 connectors with LED on bracket

Audio Interface

Chipset	Intel® ICH8-M with Realtek ALC888 HD Audio Intel High Definition Audio compliance
Interface	2 channels sound output
Connector	Onboard Audio connector with pin header Onboard CD-IN connector

Expansive Interface

Mini PCI	Two Mini-PCI socket TYPE III A (32-bit, 33MHz) Power supply: +3.3V, +5V, 3VSB
PCI-Express	One X16 and Four X1 on PICMG 1.3 Interface
PCI	Four PCI bus master on PICMG 1.3 Interface

Power and Environment

Power Requirement	+5V, +12V Requirement & optional 5V _{SB} for ATX
Dimension	338 (L) x 126 (H) mm
Temperature	Operating within 0 ~ 60 (32 ~ 140) Storage within -20 ~ 85 (-4 ~ 185)

Ordering Code

FS-A71G	Onboard VGA, Gigabit LAN, Mini-PCI, 3 x SATA, HD Audio, IrDA, USB, Serial port, LPT, GPIO, FDD
FS-A71G2	Same as above and with 2 x Gigabit LAN

The specifications may be different as the actual production.

For further product information please visit the website at <http://www.commell.com.tw>

1.3 <Block Diagram>

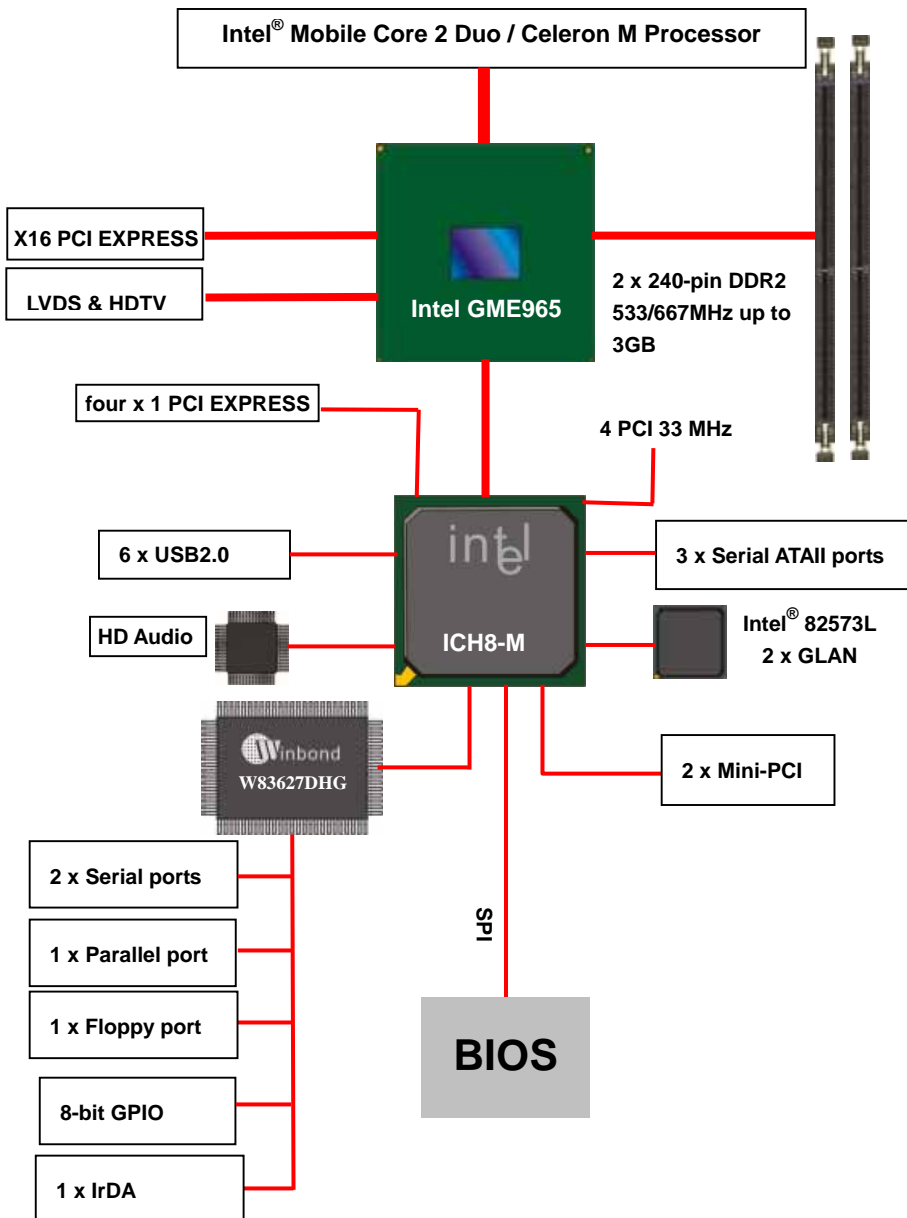

1.4 <Mechanical Drawing >

Measurement: inch

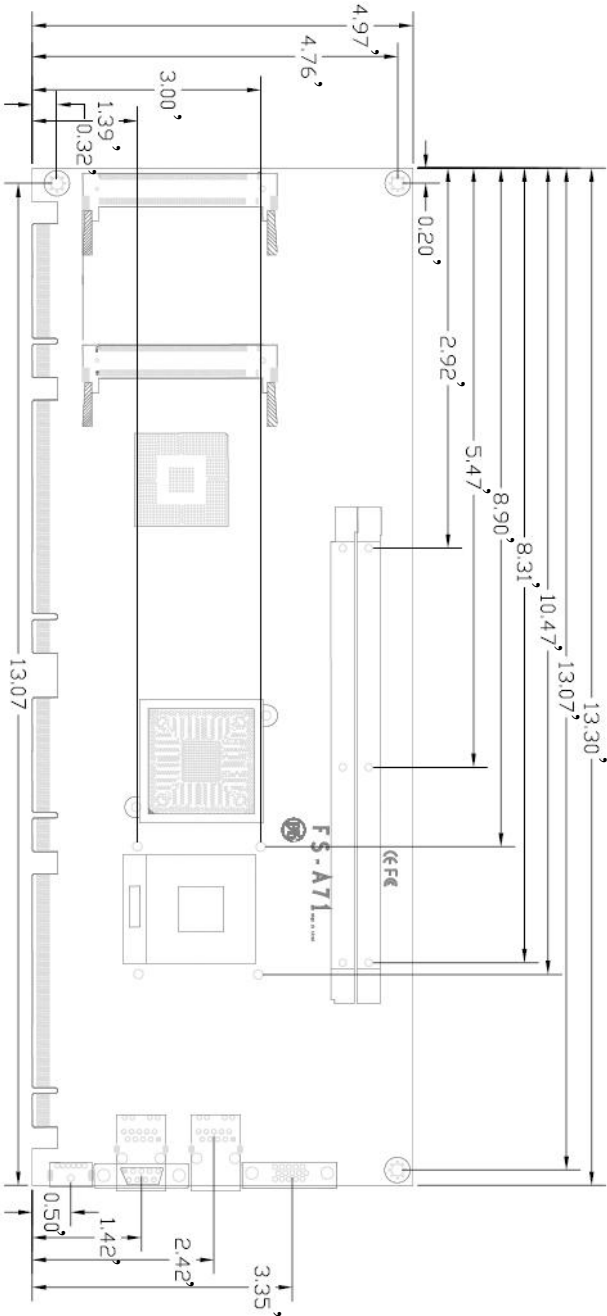

Chapter 2 <Hardware Setup>

2.1 <Connector Location>

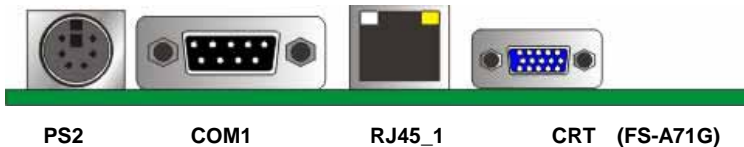
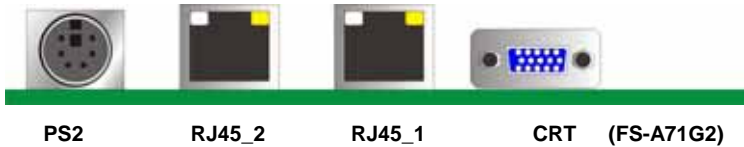
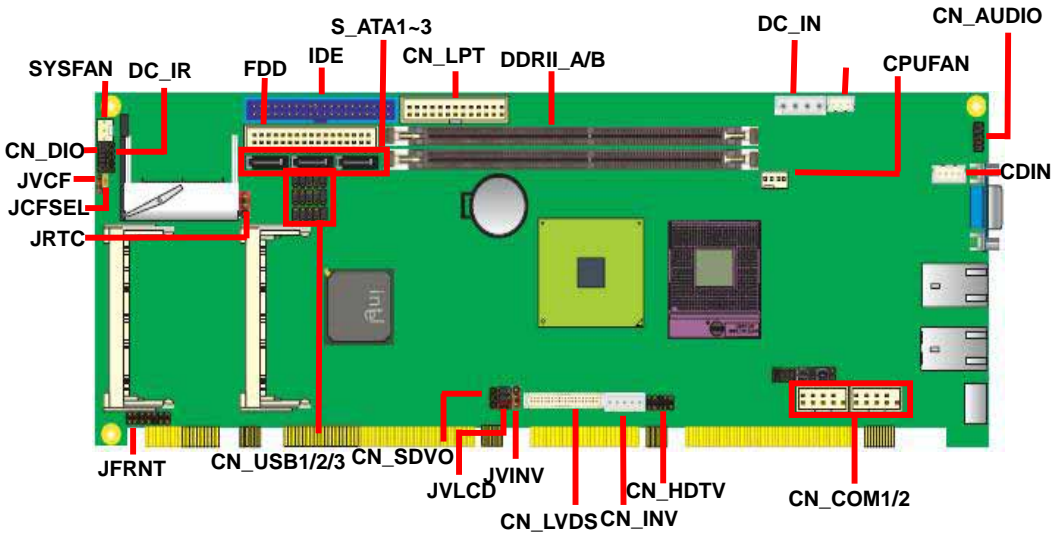

2.2 <Jumper Reference>

Jumper	Function
JRTC	CMOS Operating/Clear Setting
JVINV	LCD Inverter Voltage Setting
JVLCD	LCD Panel Voltage Setting
JVCF	CF Voltage Setting
JCSEL1/2	COM2 RS232/422/485 mode setting
JCFSEL	CF with IDE mode selection

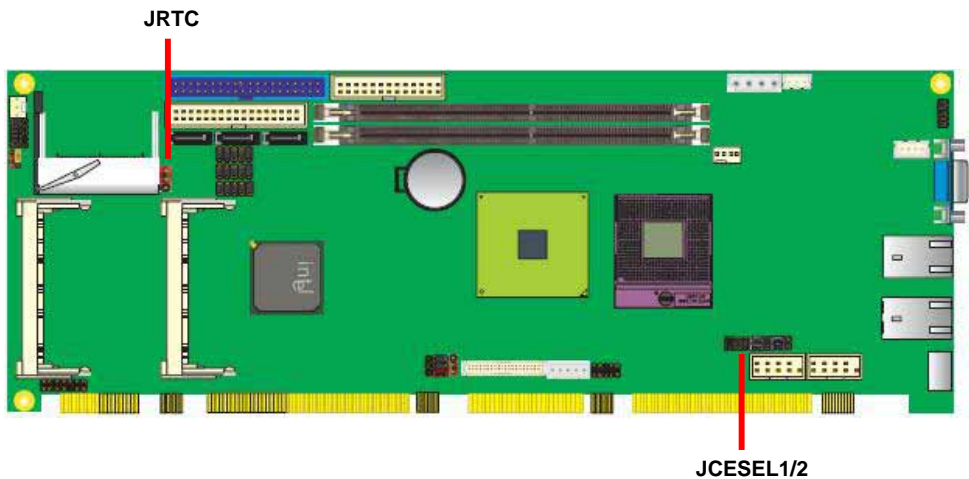

2.3 <Connector Reference>

2.3.1 <Internal Connectors>

Connector	Function	Remark
DDRIIA/B	240 -pin DDR2 SDRAM DIMM socket	Standard
FDD	34-pin floppy connector	Standard
CN_LPT	13 x 2-pin LPT connector	Standard
SATAII1/2/3	7-pin Serial ATA II connector	Standard
CN_AUDIO	5 x 2-pin audio connector	Standard
CDIN	4-pin CD-ROM audio input connector	Standard
CN_PS	3-pin ATX function connector	Standard
DC_IN	4-pin power supply connector	Standard
CN_DIO	6 x 2-pin digital I/O connector	Standard
CN_USB1/2/3	10-pin USB connector	Standard
CPUFAN	4-pin CPU cooler fan connector	Standard
SYSFAN	3-pin system cooler fan connector	Standard
CN_IR	5-pin IrDA connector	Standard
JFRNT	14-pin front panel switch/indicator connector	Standard
Mini-PCI 1/2	124-pin Mini-PCI socket	Standard
CN_COM1/2	5 x 2-pin com connector	Standard
CF	Compact Flash TYPE-II socket	Standard
CN_HDTV	5 x 2-pin HDTV interface	Standard

2.3.2 <External Connectors>

Connector	Function	Remark
CRT	DB15 VGA connector	Standard
RJ45_1/2	RJ45 LAN connector	Standard
COM	DB9 RS232 connector	Standard
PS2	PS/2 keyboard and mouse connector	Standard

2.4 <CPU and Memory Setup>

2.4.1 <CPU installation>

The board comes with the socket478 for Intel® Core 2 Duo/Celeron M **socket-P** processor only it supports new generation of Intel® Core 2 Duo/Celeron M **socket-P** processor with 533/667/800MHz of front side bus and 4MB L2 cache. Please follow the instruction to install the CPU properly.

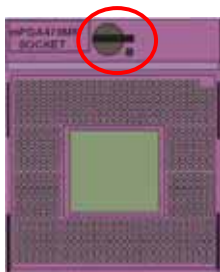

1. Use the flat-type screw drive to unlock the CPU socket



Unlock way

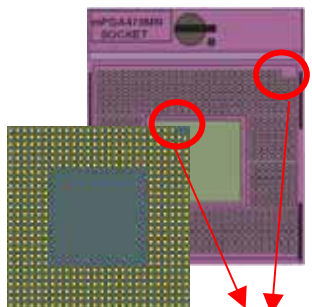

Check point

2. Follow the pin direction to install the processor on the socket

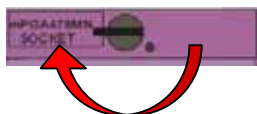

3. Lock the socket

2.4.2 <Memory installation>

FS-A71 has two 240-pin DDR2 DIMM support up to 3GB of memory capacity. The memory frequency supports 533/667MHz. Only Non-ECC supported unbuffered memory is supported only. Supports interleaved addressing in dual-channel memory configurations even when the two channels have unequal amounts of memory populated. This is called Intel® Flex Memory Technology. Flex memory provides higher performance with different sized channel populations than “Asymmetric” mode (where no interleaving is used) by allowing some interleaving.

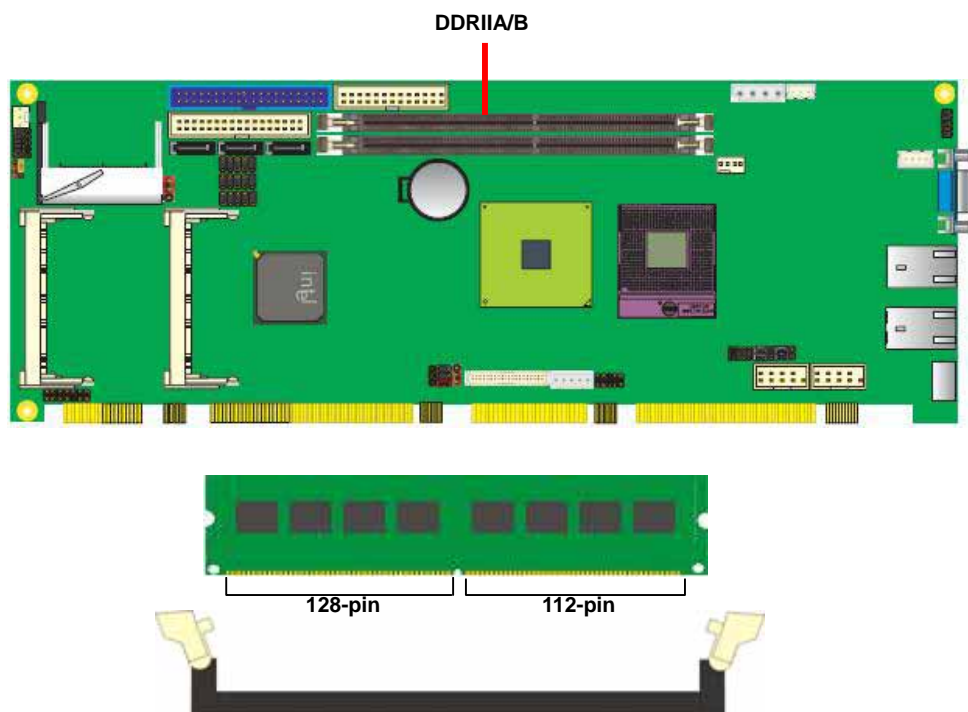

Please check the pin number to match the socket side well before installing memory module.

2.5 <CMOS Setup>

The board's data of CMOS can be setting in BIOS. If the board refuses to boot due to inappropriate CMOS settings, here is how to proceed to clear (reset) the CMOS to its default values.

Jumper: **JRTC**

Type: Onboard 3-pin Header.

JRTC	Mode
1-2	Clear CMOS
2-3	Normal Operation

Default setting

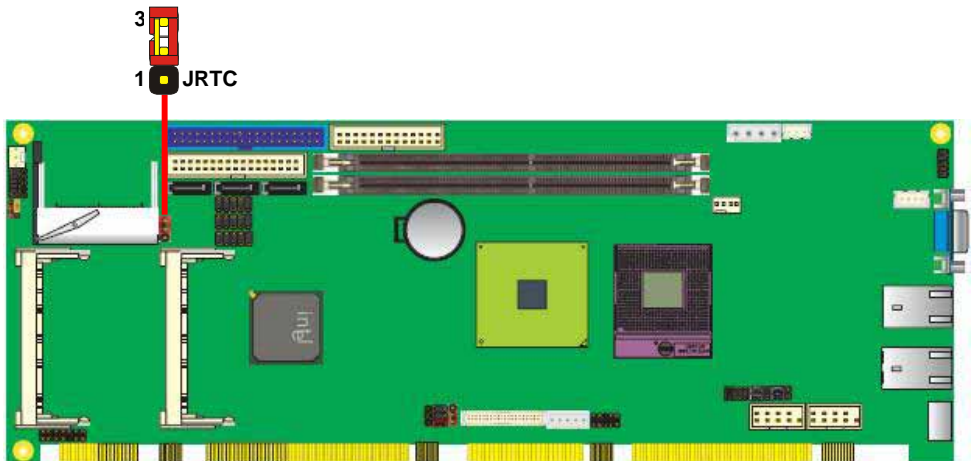

2.6 <Enhanced IDE Interface>

The board has one Ultra ATA100 IDE interface to support up to 2 ATAPI devices, or one ATAPI device and Compact Flash Type II socket, with jumper **JCFSEL** for IDE master/slave mode selection. And provide **JVCF** jumper to set +3.3V or +5V.

Jumper: **JCFSEL**

Type: onboard 3-pin header

JCFSEL	Mode
1-2	Master
2-3	Slave

Default setting: 2-3

Jumper: **JVCF**

Type: onboard 3-pin header

JVSSD	Mode
	+5V
	+3.3V

Default setting: 1-2

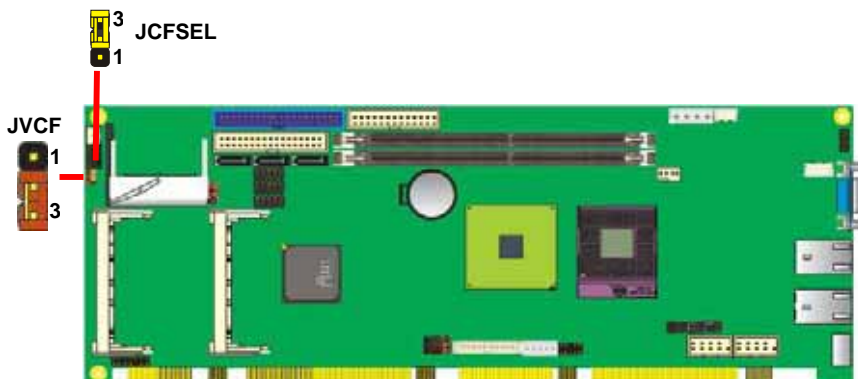

2.7 <Serial ATA installation>

FS-A71 has three Serial ATA II interfaces, the transfer rate of the Serial ATA II can be up to 300MB/s. Please go to <http://www.serialata.org/> for more about Serial ATA technology information. For more about the system setup for Serial ATA, please check the chapter of SATA configuration.

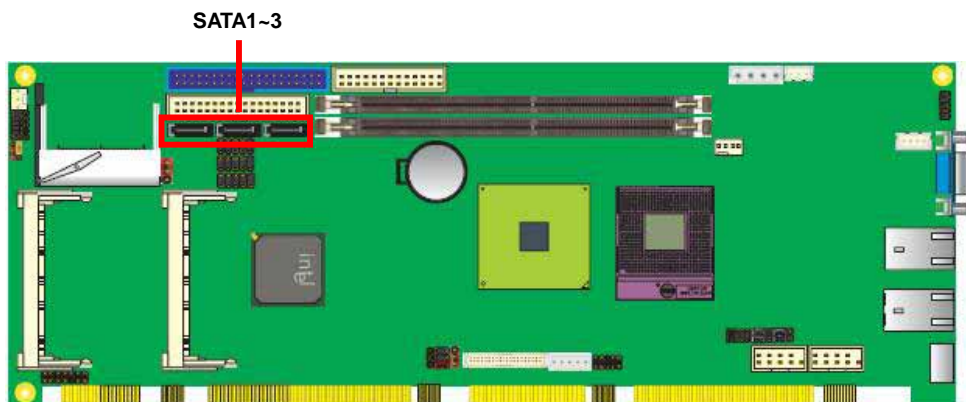

2.8 <LAN Interface>

The Intel 82573L supports triple speed of 10/100/1000Base-T, with IEEE802.3 compliance and Wake-On-LAN supported.

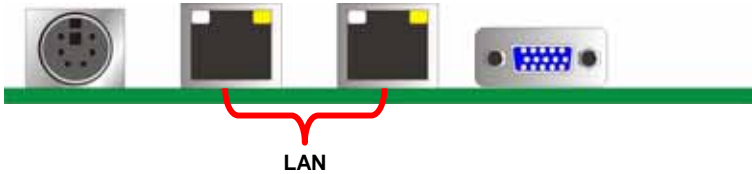

2.9 <Onboard Display Interface>

Based on Intel® GME965 chipset with built-in GMA (Graphic Media Accelerator) X3100 graphics, the board provides one DB15 connector on real external I/O port, and one 40-pin LVDS interface with 5-pin LCD backlight inverter connector. The board provides dual display function with clone mode and extended desktop mode for CRT and LVDS and TV-out.

2.9.1 <Analog Display>

Please connect your CRT or LCD monitor with DB15 male connector to the onboard DB15 female connector on bracket.



2.9.2 < Digital Display>

The board provides one 40-pin LVDS connector for 18/24-bit dual channel panels, supports up to 1600 x 1200 (UXGA) of resolution, with one LCD backlight inverter connector and one jumper for panel voltage setting

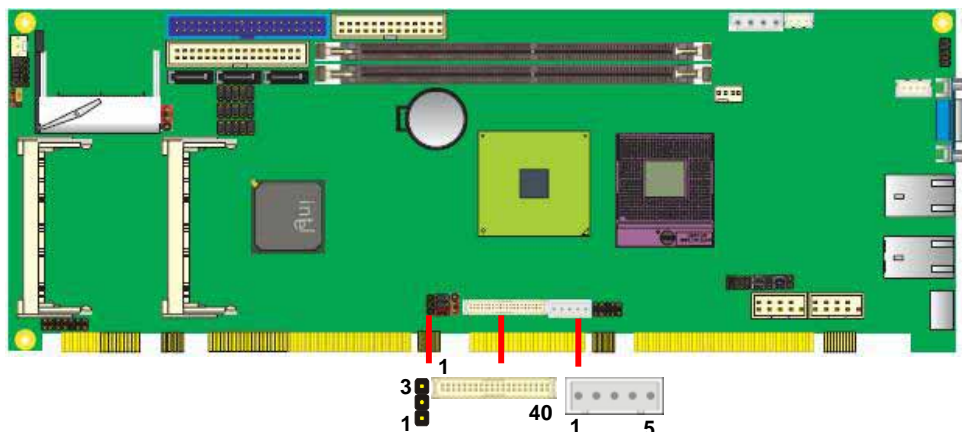

Connector: **CN_INV**

Type: 5-pin LVDS Power Header

Connector model: **JST B5B-XH-A**

Pin	Description
1	INV-Vcc
2	GND
3	GND
4	GND
5	ENABKL

Jumper: **JVLCD**

Type: 6-pin Power select Header

Pin	Description
1-2	LCDVCC (3.3V)
3-4	LCDVCC (5V)
5-6	LCDVCC (12V)

Jumper: **JVINV**

Type: 3-pin Power select Header

Pin	Description
1-2	INV_VCC (12V)
2-3	INV_VCC (5V)

Connector: **CN_LVDS**

Type: onboard 40-pin connector for LVDS connector

Connector model: **HIROSE DF13-40DP-1.25V**

Pin	Signal	Pin	Signal
2	LCDVCC	1	LCDVCC
4	GND	3	GND
6	ATX0-	5	BTX0-
8	ATX0+	7	BTX0+
10	GND	9	GND
12	ATX1-	11	BTX1-
14	ATX1+	13	BTX1+
16	GND	15	GND
18	ATX2-	17	BTX2-
20	ATX2+	19	BTX2+
22	GND	21	GND
24	ACLK-	23	BTX3-
26	ACLK+	25	BTX3+
28	GND	27	GND
30	ATX3-	29	BCLK-
32	ATX3+	31	BCLK+
34	GND	33	GND
36	DDCPCLK	35	N/C
38	DDCPDATA	37	N/C
40	N/C	39	N/C

FS-A71 User's Manual

To setup the LCD, you need the component below:

1. A panel with LVDS interfaces.
2. An inverter for panel's backlight power.
3. A LCD cable and an inverter cable.

For the cables, please follow the pin assignment of the connector to make a cable, because every panel has its own pin assignment, so we do not provide a standard cable; please find a local cable manufacture to make cables.

LCD Installation Guide:

1. Preparing the **FS-A71**, **LCD panel** and the **backlight inverter**.

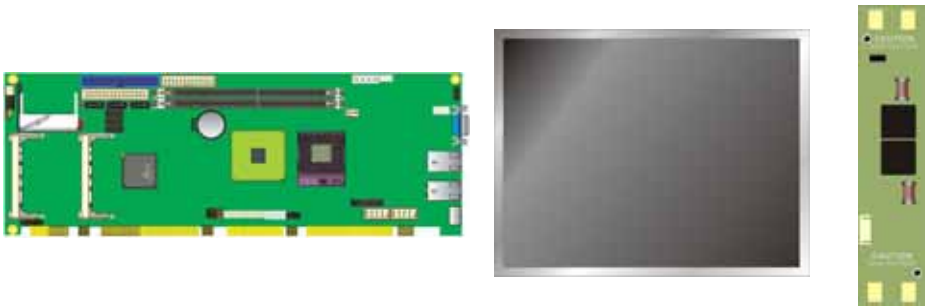

2. Please check the datasheet of the panel to see the voltage of the panel, and set the jumper **JVLCD** to +12V or +5V or +3.3V.
3. You would need a LVDS type cable.

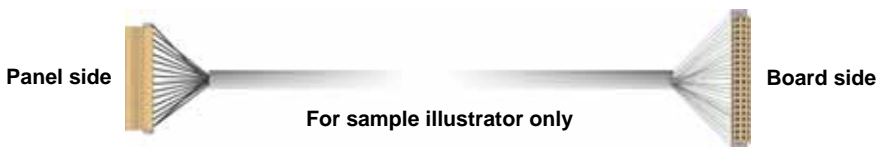

4. To connect all of the devices well.

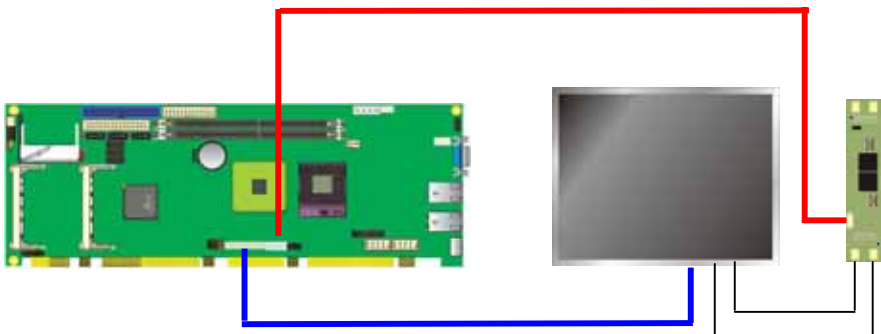

FS-A71 User's Manual

After setup the devices well, you need to select the LCD panel type in the BIOS.

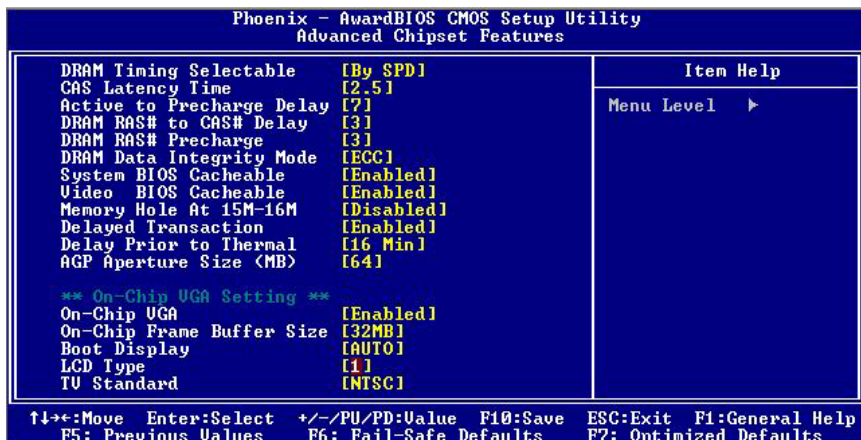

The panel type mapping is list below:

BIOS panel type selection form			
18-bit Single channel		24-bit Dual channel	
NO.	Output format	NO.	Output format
1	800 x 480	10	1024 x 768
2	800 x 600	11	1280 x 768
3	1024 x 768	12	1280 x 1024
24-bit Single channel		13	1366 x 768
4	1024 x 768	14	1400 x 1050 @ 108Mhz
5	1280 x 768	15	1600 x 1200
6	1280 x 800		
7	1280 x 1024		
8	1366 x 768		
9	1600 x 1200		

2.9.3<TV-out Interface>

The board provides an HDTV interface with Intel® GME965, supports PAL and NTSC of TV system, and display (clone or extended desktop) function with CRT, LVDS.

Connector: **CN_HDTV**

Connector type: 10-pin header HDTV connector (pitch = 2.54mm)

Pin Number	Assignment	Pin Number	Assignment
1	GND	2	DACB1
3	DACB2	4	N/C
5	GND	6	GND
7	DACB3	8	N/C
9	N/C	10	N/C

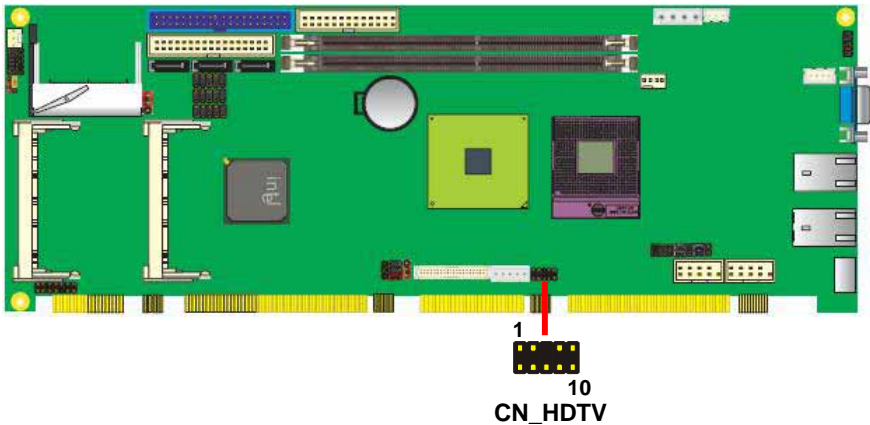

To connect the TV set, please follow the diagram below to setup your system:

YPrPb Component Cable
(For HDTV)

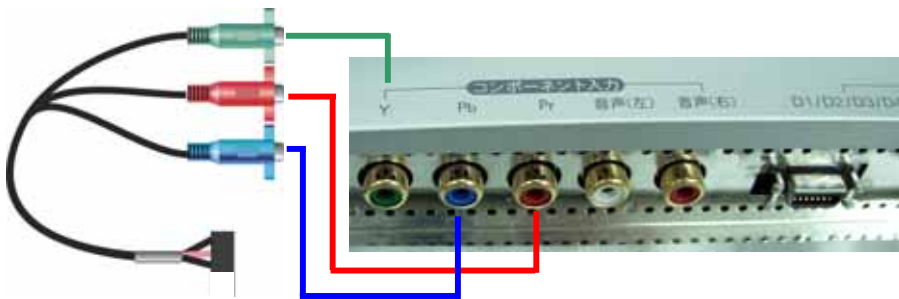
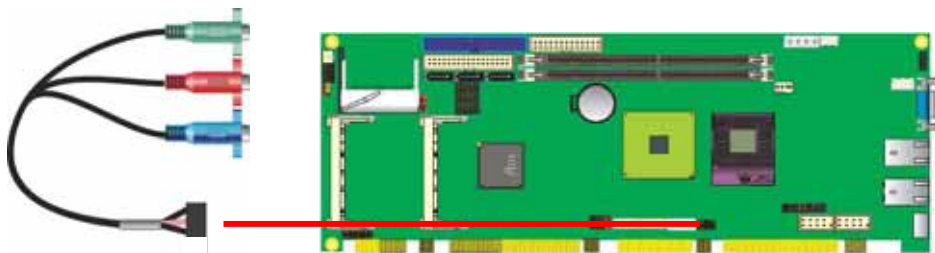

S-VIDEO or Composite

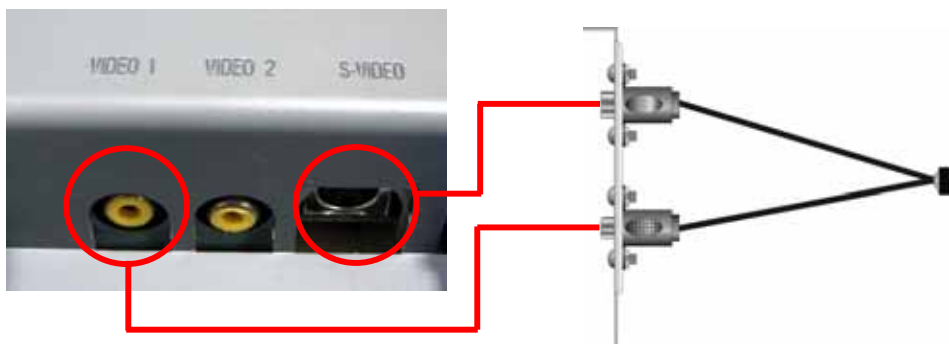

2.10 <Audio Installation>

The board integrates onboard audio interface with REALTEK ALC888 codec, with Intel next generation of Audio standard as High Definition Audio, it offers more sound and other advantages than former HD Audio compliance.

The main specifications of ALC888 are:

- **High-performance DACs with 100dB S/N ratio**
- **8 DAC channels support 16/20/24-bit PCM format for 2 audio solution**
- **Compatible with HD Audio**
- **Meets Microsoft WHQL/WLP 2.0 audio requirements**

The board provides 2 channels speaker and from pin header MIC-in ports through Audio cable.

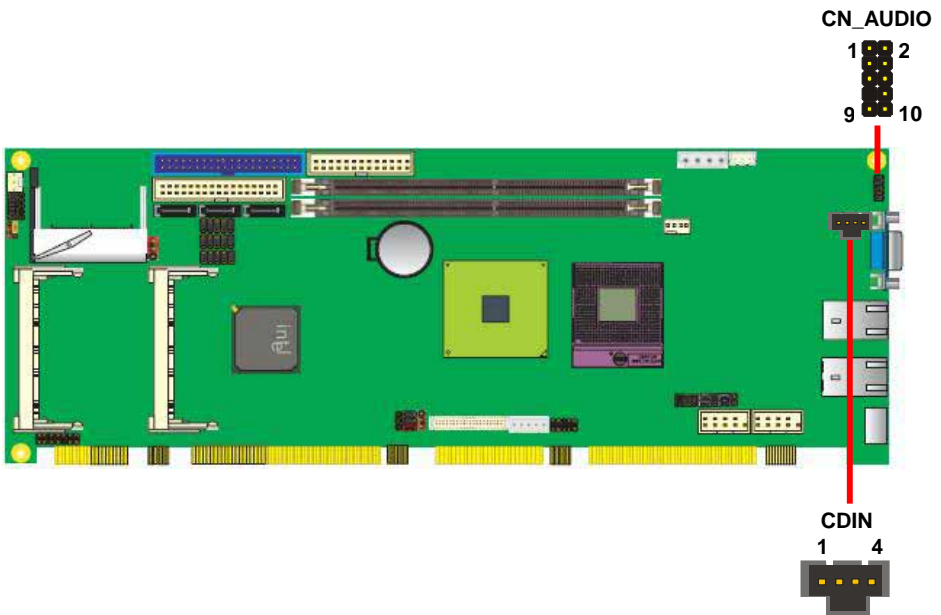

Connector: CN_AUDIO

Type: 10-pin (2 x 5) header (pitch = 2.54mm)

Pin	Description	Pin	Description
1	MIC2_L	2	Ground
3	MIC2_R	4	VCC
5	FP_OUT_R	6	MIC2_JD
7	SENSE	8	N/C
9	FP_OUT_L	10	LINE2_JD

Connector: CDIN

Type: 4-pin header (pitch = 2.54mm)

Pin	Description
1	CD – Left
2	Ground
3	Ground
4	CD – Right

2.11 <GPIO interface>

The board provides a programmable 8-bit digital I/O interface for control panel application.

Connector: **CN_DIO**

Type: onboard 2 x 6-pin header, pitch=2.0mm

Pin	Description	Pin	Description
1	Ground	2	Ground
3	GP10	4	GP14
5	GP11	6	GP15
7	GP12	8	GP16
9	GP13	10	GP17
11	VCC	12	+12V

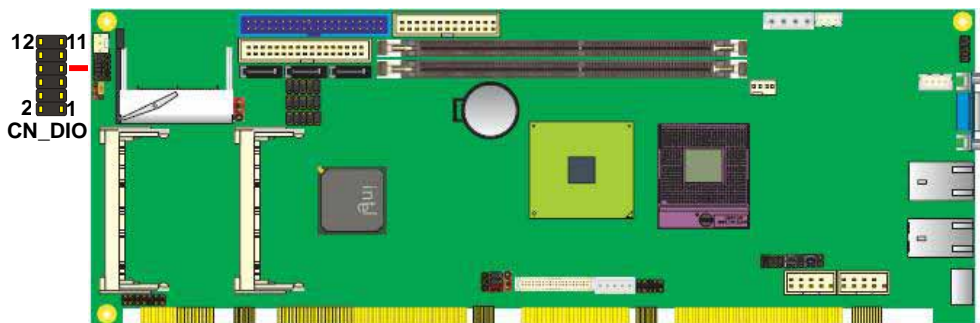

2.12 <USB2.0 Interface>

Based on Intel® ICH8-M, the board provides six USB2.0 ports six on board pin header for on PICMG 1.3 Interface. The USB2.0 interface provides up to 480Mbps of transferring rate.

The Intel® ICH8-M contains two Enhanced Host Controller Interface (EHCI) and five Universal Host Controller Interfaces (UHCI) it can determine whether your connected device is for USB1.1 or USB2.0, and change the transfer rate automatically.

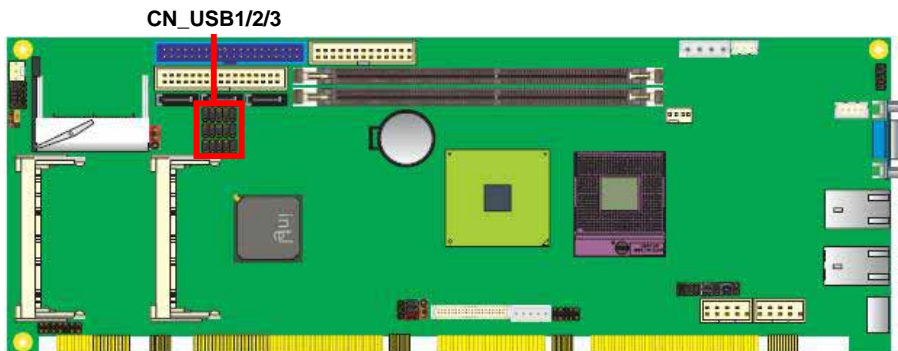

Connector: **CN_USB1/2/3**

Type: 10-pin (5 x 2) header for USB Port

Pin	Description	Pin	Description
1	VCC	2	VCC
3	Data0-	4	Data1-
5	Data0+	6	Data1+
7	Ground	8	Ground
9	Ground	10	N/C

2.12 <Power and Fan Installation>

The **FS-A71** provides a standard ATX power supply with **4-pin** ATX connector , and the board provides one **4-pin** fan connector supporting smart fan for CPU cooler and two 3-pin cooler fan connectors for system.

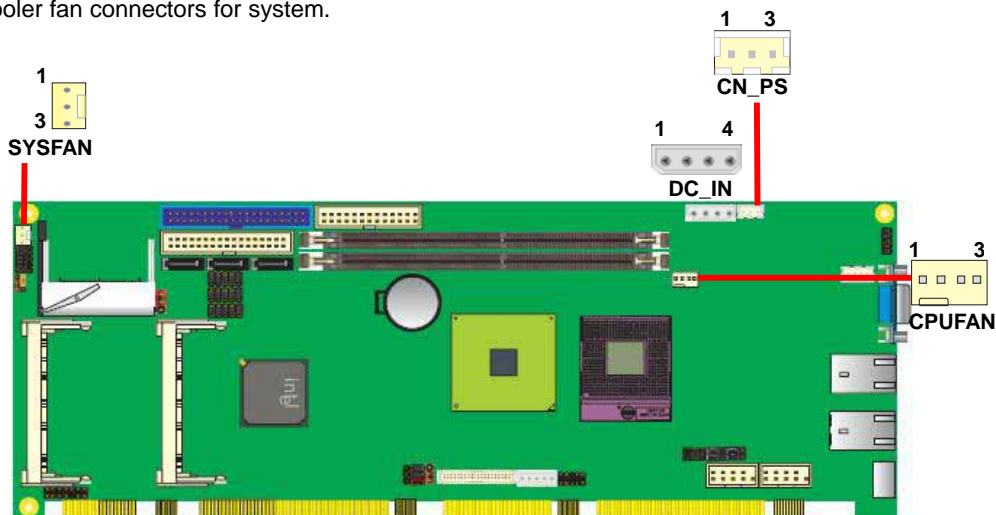

Connector: **DC_IN**

Type: 4-pin P-type connector for +5V/+12V input

Pin	Description	Pin	Description	Pin	Description	Pin	Description
1	+12V	2	Ground	3	Ground	4	+5V

Connector: **CN_PS**

Type: 3-pin ATX function connector

Pin	Description	Pin	Description	Pin	Description
1	5V Standby	2	Ground	3	Power On

Connector: **CPUFAN**

Type: 4-pin fan wafer connector

Pin	Description	Pin	Description	Pin	Description	Pin	Description
1	Ground	2	+12V	3	Fan Speed Detection	4	Fan Control

Connector: **SYSFAN**

Type: 3-pin fan wafer connector

Pin	Description	Pin	Description	Pin	Description
1	Ground	2	+12V	3	Sense

2.13 <Serial Port>

The board supports one RS232 serial port and one jumper selectable RS232/422/485 serial ports. The jumper JCSEL1 /2 can let you configure the communicating modes for COM2.

Connector: **CN_COM1/2**

Type: 10-pin (5 x 2) 2.54mm x 2.54mm-pitch header.

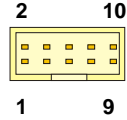

Pin	Description	Pin	Description
1	DCD/422RX-/485-	2	RXD/422RX+/485+
3	TXD/422TX+	4	DTR/422TX-
5	GND	6	DSR
7	RTS	8	CTS
9	RI	10	N/C

Jumper: **JCSEL1, JCSEL2**

Type: On bond 12-Pin and 8-Pin header

	JCSEL1	JCSEL2
SIR		
RS-422		
RS-485		
RS-232		

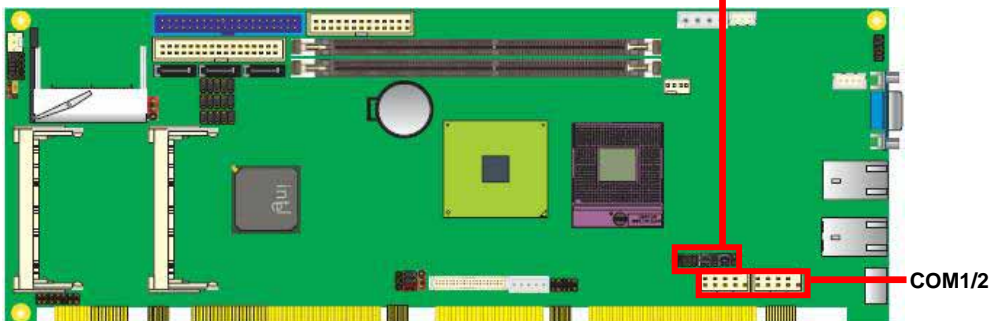

2.14 <Switch and Indicator>

The **JFRNT** provides front control panel of the board, such as power button, reset and beeper, etc. Please check well before you connecting the cables on the chassis.

Connector: **JFRNT**

Type: onboard 14-pin (2 x 7) 2.54-pitch header

Function	Signal	PIN		Signal	Function
IDE LED	HDLED+	1	2	PWDLED+	Power LED
	HDLED-	3	4	N/C	
Reset	Reset+	5	6	PWDLED-	Speaker
	Reset-	7	8	SPKIN+	
N/C		9	10	N/C	
Power Button	PWRBT+	11	12	N/C	
	PWRBT-	13	14	SPKIN-	

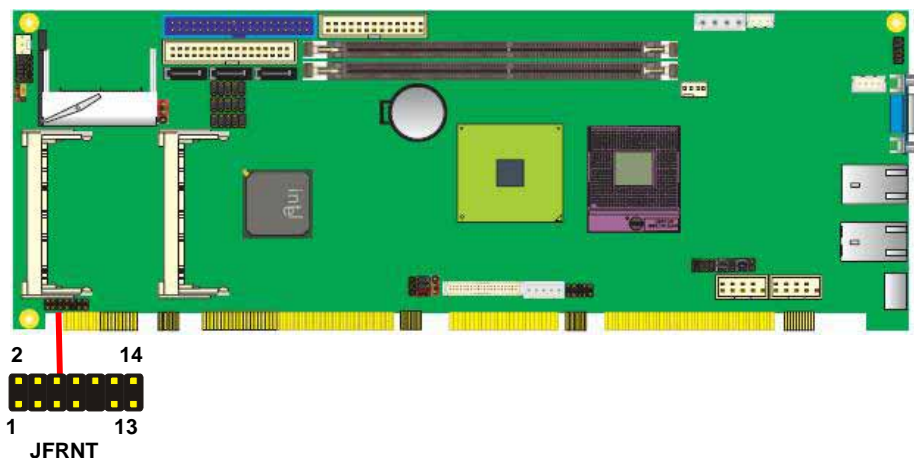

(This Page is left for Blank)

Chapter 3 <System Configuration>

3.1 <Audio Configuration>

The board integrates Intel® ICH8-M with REALTEK ALC888 code. It can support 2-channel sound under system configuration. Please follow the steps below to setup your sound system.

1. Install REALTEK HD Audio driver.



2. Launch the control panel and Sound Effect Manager.
3. Select Speaker Configuration



4. Select the sound mode to meet your speaker system.

3.2 <Video Memory Setup>

Based on Intel® GME965 chipset with GMA (Graphic Media Accelerator) X3100, the board supports Intel® DVMT (Dynamic Video Memory Technology) 4.0, which would allow the video memory be triggered up to 384MB.

To support DVMT, you need to install the Intel® GMA X3100 Driver with supported OS.

BIOS Setup:

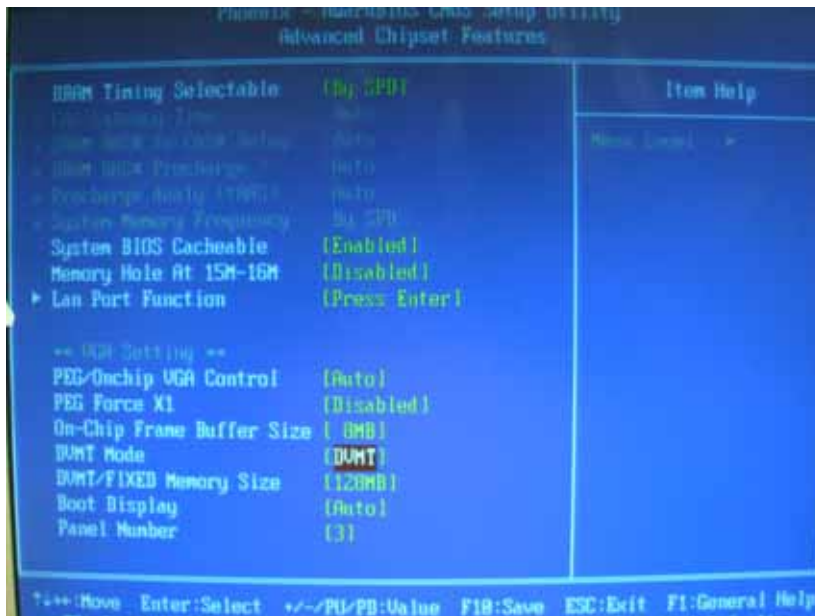

On-Chip Video Memory Size: This option combines three items below for setup.

On-Chip Frame Buffer Size:

This item can let you select video memory which been allocated for legacy VGA and SVGA graphics support and compatibility. The available option is **1MB** and **8MB**.

DVMT Mode:

This item can let you select graphics memory which Fixed or DVMT.

DVMT/FIXED Memory Size:

This item can let you select a maximum size of dynamic amount usage of video memory, the system would configure the video memory depends on your application, this item is strongly recommend to be selected as **MAX**.

Chapter 4 <BIOS Setup>

The motherboard uses the Award BIOS for the system configuration. The Award BIOS in the single board computer is a customized version of the industrial standard BIOS for IBM PC AT-compatible computers. It supports Intel x86 and compatible CPU architecture based processors and computers. The BIOS provides critical low-level support for the system central processing, memory and I/O sub-systems.

The BIOS setup program of the single board computer let the customers modify the basic configuration setting. The settings are stored in a dedicated battery-backed memory, NVRAM, retains the information when the power is turned off. If the battery runs out of the power, then the settings of BIOS will come back to the default setting.

The BIOS section of the manual is subject to change without notice and is provided here for reference purpose only. The settings and configurations of the BIOS are current at the time of print, and therefore they may not be exactly the same as that displayed on your screen.

To activate CMOS Setup program, press key immediately after you turn on the system. The following message "Press DEL to enter SETUP" should appear in the lower left hand corner of your screen. When you enter the CMOS Setup Utility, the Main Menu will be displayed as **Figure 4-1**. You can use arrow keys to select your function, press <Enter> key to accept the selection and enter the sub-menu.

Figure 4-1 CMOS Setup Utility Main Screen



(This Page is Left for Blank)

Appendix A <I/O Port Pin Assignment>

A.1 <Serial ATA Port>

Connector: **SATA1/2/3**

Type: 7-pin wafer connector

1 7

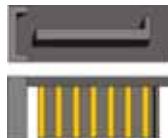

1	2	3	4	5	6	7
GND	RSATA_TXP1	RSATA_TXN1	GND	RSATA_RXN1	RSATA_RXP1	GND

A.2 <IrDA Port>

Connector: **CN_IR**

Type: 5-pin header for SIR Port

JCSEL1 must jump to "IrDA"

Pin	Description
1	Vcc
2	N/C
3	IRRX
4	Ground
5	IRTX



A.3 <VGA Port>

Connector: **CRT**

Type: 15-pin D-sub female connector on bracket

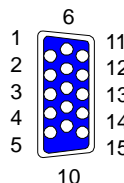

Pin	Description	Pin	Description	Pin	Description
1	RED	6	Ground	11	N/C
2	GREEN	7	Ground	12	DDC_DA
3	BLUE	8	Ground	13	HSYNC
4	N/C	9	+5V	14	VSYNC
5	Ground	10	Ground	15	DDC_CLK

A.4 <LAN Port>

Connector: **RJ45 1/2**

Type: RJ45 connector with LED on bracket

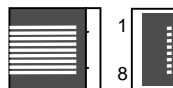

Pin	1	2	3	4	5	6	7	8
Description	TRD0+	TRD0-	TRD1+	TRD2+	TRD2-	TRD1-	TRD3+	TRD3-

A.5 <Floppy Port>

Connector: **FDD**

Type: 34-pin (2x 17) 2.54-pitch box header

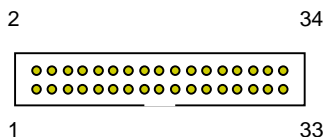

Pin	Description	Pin	Description
1	Ground	2	DRIVE DENSITY SELECT 0
3	Ground	4	DRIVE DENSITY SELECT 1
5	Ground	6	N/C
7	Ground	8	INDEX-
9	Ground	10	MOTOR ENABLE A-
11	Ground	12	DRIVER SELECT B-
13	Ground	14	DRIVER SELECT A-
15	Ground	16	MOTOR ENABLE B-
17	Ground	18	DIRECTION-
19	Ground	20	STEP-
21	Ground	22	WRITE DATA-
23	Ground	24	WRITE GATE-
25	Ground	26	TRACK 0-
27	Ground	28	WRITE PROTECT-
29	Ground	30	READ DATA-
31	Ground	32	HEAD SELECT-
33	Ground	34	DISK CHANGE-

A.6 <Parallel Port>

Connector: **LPT (PRINTER)**

Type: 26-pin (2 x 13) 2.54-pitch box header

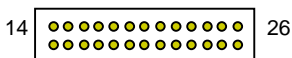

Pin	Description	Pin	Description
1	STROBE-	14	AUTO FEED-
2	D0	15	ERROR-
3	D1	16	INITIALIZE-
4	D2	17	SELECT INPUT-
5	D3	18	Ground
6	D4	19	Ground
7	D5	20	Ground
8	D6	21	Ground
9	D7	22	Ground
10	ACKNOWLEDGE-	23	Ground
11	BUSY	24	Ground
12	PAPER EMPTY	25	Ground
13	SELECT+	26	N/C

Appendix B <System Resources>

B1. <I/O Port Address Map>

[00000000 - 0000000F]	Direct memory access controller
[00000000 - 00000CF7]	PCI bus
[00000010 - 0000001F]	Motherboard resources
[00000020 - 00000021]	Programmable interrupt controller
[00000022 - 0000003F]	Motherboard resources
[00000040 - 00000043]	System timer
[00000044 - 0000005F]	Motherboard resources
[00000060 - 00000060]	Standard 101/102-Key or Microsoft Natural PS/2 Keyboard
[00000061 - 00000061]	System speaker
[00000062 - 00000063]	Motherboard resources
[00000064 - 00000064]	Standard 101/102-Key or Microsoft Natural PS/2 Keyboard
[00000065 - 0000006F]	Motherboard resources
[00000070 - 00000073]	System CMOS/real time clock
[00000074 - 0000007F]	Motherboard resources
[00000080 - 00000090]	Direct memory access controller
[00000091 - 00000093]	Motherboard resources
[00000094 - 0000009F]	Direct memory access controller
[000000A0 - 000000A1]	Programmable interrupt controller
[000000A2 - 000000BF]	Motherboard resources
[000000C0 - 000000DF]	Direct memory access controller
[000000E0 - 000000EF]	Motherboard resources
[000000F0 - 000000FF]	Numeric data processor
[00000170 - 00000177]	Secondary IDE Channel
[000001F0 - 000001F7]	Primary IDE Channel
[00000274 - 00000277]	ISAPNP Read Data Port
[00000279 - 00000279]	ISAPNP Read Data Port
[000002F8 - 000002FF]	Communications Port (COM2)
[00000376 - 00000376]	Secondary IDE Channel

[00000378 - 0000037F]	Printer Port (LPT1)
[00000380 - 0000038B]	Mobile Intel(R) 965 Express Chipset Family
[000003C0 - 000003DF]	Mobile Intel(R) 965 Express Chipset Family
[000003F0 - 000003F5]	Standard floppy disk controller
[000003F6 - 000003F6]	Primary IDE Channel
[000003F7 - 000003F7]	Standard floppy disk controller
[000003F8 - 000003FF]	Communications Port (COM1)
[00000400 - 000004BF]	Motherboard resources
[000004D0 - 000004D1]	Motherboard resources
[00000500 - 0000051F]	Intel(R) ICH8 Family SMBus Controller - 283E
[00000680 - 000006FF]	Motherboard resources
[00000778 - 0000077B]	Printer Port (LPT1)
[00000880 - 0000088F]	Motherboard resources
[00000A79 - 00000A79]	ISAPNP Read Data Port
[00000D00 - 0000FFFF]	PCI bus
[0000C000 - 0000CFFF]	Intel(R) ICH8 Family PCI Express Root Port 1 - 283F
[0000D000 - 0000DFFF]	Intel(R) ICH8 Family PCI Express Root Port 5 - 2847
[0000DF00 - 0000DF1F]	Intel(R) PRO/1000 PL Network Connection
[0000F300 - 0000F30F]	Intel(R) ICH8M 3 port Serial ATA Storage Controller - 2828
[0000F400 - 0000F40F]	Intel(R) ICH8M 3 port Serial ATA Storage Controller - 2828
[0000F500 - 0000F503]	Intel(R) ICH8M 3 port Serial ATA Storage Controller - 2828
[0000F600 - 0000F607]	Intel(R) ICH8M 3 port Serial ATA Storage Controller - 2828
[0000F700 - 0000F703]	Intel(R) ICH8M 3 port Serial ATA Storage Controller - 2828
[0000F800 - 0000F807]	Intel(R) ICH8M 3 port Serial ATA Storage Controller - 2828
[0000F900 - 0000F90F]	Intel(R) ICH8M Ultra ATA Storage Controllers - 2850
[0000FA00 - 0000FA1F]	Intel(R) ICH8 Family USB Universal Host Controller - 2832
[0000FB00 - 0000FB1F]	Intel(R) ICH8 Family USB Universal Host Controller - 2831
[0000FC00 - 0000FC1F]	Intel(R) ICH8 Family USB Universal Host Controller - 2830
[0000FD00 - 0000FD1F]	Intel(R) ICH8 Family USB Universal Host Controller - 2835
[0000FE00 - 0000FE1F]	Intel(R) ICH8 Family USB Universal Host Controller - 2834
[0000FF00 - 0000FF07]	Mobile Intel(R) 965 Express Chipset Family

B2. <Memory Address Map>

[00000000 - 0009FFFF]	System board
[000A0000 - 000BFFFF]	PCI bus
[000A0000 - 000BFFFF]	Mobile Intel(R) 965 Express Chipset Family
[000C0000 - 000DFFFF]	PCI bus
[000E0000 - 000EFFFF]	System board
[000F0000 - 000FFFFF]	System board
[00100000 - 3F6DFFFF]	System board
[3F6E0000 - 3F6FFFFF]	System board
[3F700000 - FEBFFFFF]	PCI bus
[3F700000 - 3F7FFFFF]	System board
[D0000000 - DFFFFFFF]	Mobile Intel(R) 965 Express Chipset Family
[E0000000 - EFFFFFFF]	Motherboard resources
[FD700000 - FD7FFFFF]	Mobile Intel(R) 965 Express Chipset Family
[FD9F0000 - FD9FFFFF]	Mass Storage Controller
[FDA00000 - FDAFFFFF]	Mobile Intel(R) 965 Express Chipset Family
[FDB00000 - FDBFFFFF]	Intel(R) ICH8 Family PCI Express Root Port 5 - 2847
[FDC00000 - FDCFFFFF]	Intel(R) ICH8 Family PCI Express Root Port 5 - 2847
[FDCE0000 - FDCFFFFF]	Intel(R) PRO/1000 PL Network Connection
[FDD00000 - FDDFFFFF]	Intel(R) ICH8 Family PCI Express Root Port 1 - 283F
[FDE00000 - FDEFFFFF]	Intel(R) ICH8 Family PCI Express Root Port 1 - 283F
[FDFF4000 - FDFF7FFF]	Microsoft UAA Bus Driver for High Definition Audio
[FDFFD000 - FDFFD0FF]	Intel(R) ICH8 Family SMBus Controller - 283E
[FDFFE000 - FDFFE3FF]	Intel(R) ICH8 Family USB2 Enhanced Host Controller - 2836
[FDFFF000 - FDFFF3FF]	Intel(R) ICH8 Family USB2 Enhanced Host Controller - 283A
[FEC00000 - FEC00FFF]	System board
[FED14000 - FED1DFFF]	System board
[FED20000 - FED9FFFF]	System board
[FEE00000 - FEE00FFF]	System board
[FFB00000 - FFB7FFFF]	System board
[FFB80000 - FFBFFFFF]	Intel(R) 82802 Firmware Hub Device
[FFF00000 - FFFFFFFF]	System board

B3. <System IRQ Resources>

(ISA) 0	System timer
(ISA) 1	Standard 101/102-Key or Microsoft Natural PS/2 Keyboard
(ISA) 3	Communications Port (COM2)
(ISA) 4	Communications Port (COM1)
(ISA) 6	Standard floppy disk controller
(ISA) 8	System CMOS/real time clock
(ISA) 9	Microsoft ACPI-Compliant System
(ISA) 13	Numeric data processor
(ISA) 14	Primary IDE Channel
(ISA) 15	Secondary IDE Channel
(PCI) 10	Mass Storage Controller
(PCI) 11	Intel(R) ICH8 Family SMBus Controller - 283E
(PCI) 16	Intel(R) ICH8 Family PCI Express Root Port 1 - 283F
(PCI) 16	Intel(R) ICH8 Family PCI Express Root Port 5 - 2847
(PCI) 16	Intel(R) ICH8 Family USB Universal Host Controller - 2834
(PCI) 16	Intel(R) PRO/1000 PL Network Connection
(PCI) 16	Mobile Intel(R) 965 Express Chipset Family
(PCI) 18	Intel(R) ICH8 Family USB Universal Host Controller - 2832
(PCI) 18	Intel(R) ICH8 Family USB2 Enhanced Host Controller - 283A
(PCI) 19	Intel(R) ICH8 Family USB Universal Host Controller - 2831
(PCI) 19	Intel(R) ICH8M 3 port Serial ATA Storage Controller - 2828
(PCI) 21	Intel(R) ICH8 Family USB Universal Host Controller - 2835
(PCI) 22	Microsoft UAA Bus Driver for High Definition Audio
(PCI) 23	Intel(R) ICH8 Family USB Universal Host Controller - 2830
(PCI) 23	Intel(R) ICH8 Family USB2 Enhanced Host Controller - 2836

Appendix C <Flash BIOS>

C.1 BIOS Auto Flash Tool

The board is based on Award BIOS and can be updated easily by the BIOS auto flash tool. You can download the tool online at the address below:

<http://www.award.com>

<http://www.commell.com.tw/support/support.htm>

File name of the tool is "awdf flash.exe", it's the utility that can write the data into the BIOS flash chip and update the BIOS.

C.2 Flash Method

1. Please make a bootable floppy disk.
2. Get the last .bin files you want to update and copy it into the disk.
3. Copy awardflash.exe to the disk.
4. Power on the system and flash the BIOS. (Example: C:/ awardflash XXX.bin)
5. Re-start the system.

Any question about the BIOS re-flash please contact your distributors or visit the web-site at below:

<http://www.commell.com.tw/support/support.htm>

Appendix D <Programming GPIO's>

The GPIO can be programmed with the MSDOS debug program using simple IN/OUT commands. The following lines show an example how to do this.

```
GPIO0.....GPIO7  bit0.....bit7
-o 2E 87                ;enter configuration
-o 2E 87
-o 2E 07
-o 2F 09                ;enable GPIO function
-o 2E 30
-o 2F 02                ;enable GPIO configuration
-o 2E F0
-o 2F xx                ;set GPIO as input/output; set '1' for input,'0' for
                        output
-o 2E F1
-o 2F xx                ;if set GPIO's as output,in this register its value can
                        be set

Optional :
-o 2E F2
-o 2F xx                ; Data inversion register ; '1' inverts the current value
                        of the bits ,'0' leaves them as they are
-o 2E 30
-o 2F 02                ; active GPIO's
```

For further information, please refer to Winbond W83627DHG datasheet.

Appendix E <Watch Dog timer Setting >

The watchdog timer makes the system auto-reset while it stops to work for a period. The integrated watchdog timer can be setup as system reset mode by program.

Timeout Value Range

- 1 to 255
- Second or Minute

Program Sample

Watchdog timer setup as system reset with 5 second of timeout

```
2E, 87
2E, 87
2E, 07
2F, 08      Logical Device 8
2E, 30      Activate
2F, 01
2E, F5      Set as Second*
2F, 00
2E, F6      Set as 5
2F, 05
```

* Minute: bit 3 = 0; Second: bit 3 = 1

You can select Timer setting in the BIOS, after setting the time options, the system will reset according to the period of your selection.



Contact Information

Any advice or comment about our products and service, or anything we can help you please don't hesitate to contact with us. We will do our best to support you for your products, projects and business.

Taiwan Commate Computer Inc.

Address	8F, No. 94, Sec. 1, Shin Tai Wu Rd., Shi Chih Taipei Hsien, Taiwan
TEL	+886-2-26963909
FAX	+886-2-26963911
Website	http://www.commell.com.tw
E-Mail	info@commell.com.tw (General Information) tech@commell.com.tw (Technical Support)

Commell is a brand name of Taiwan commate computer Inc.