



Spectra T950B Library

Site Preparation Guide



SPECTRALOGIC.COM

Copyright

Copyright © 2006 – 2015 Spectra Logic Corporation. All rights reserved. This item and the information contained herein are the property of Spectra Logic Corporation.

Notices

Except as expressly stated herein, Spectra Logic Corporation makes its products and associated documentation on an “AS IS” BASIS, WITHOUT WARRANTY OF ANY KIND, EITHER EXPRESSED OR IMPLIED, INCLUDING BUT NOT LIMITED TO THE IMPLIED WARRANTIES OF MERCHANTABILITY OR FITNESS FOR A PARTICULAR PURPOSE, BOTH OF WHICH ARE EXPRESSLY DISCLAIMED. In no event shall Spectra Logic be liable for any loss of profits, loss of business, loss of use or data, interruption of business, or for indirect, special, incidental or consequential damages of any kind, even if Spectra Logic has been advised of the possibility of such damages arising from any defect or error.

Information furnished in this manual is believed to be accurate and reliable. However, no responsibility is assumed by Spectra Logic for its use. Due to continuing research and development, Spectra Logic may revise this publication from time to time without notice, and reserves the right to change any product specification at any time without notice.

Trademarks

BlueScale, CC, Spectra, SpectraGuard, Spectra Logic, TeraPack, and TranScale are registered trademarks of Spectra Logic Corporation. ArchiveGrade, BlackPearl, IntraCloud, nTier Verde, and Verde are trademarks of Spectra Logic Corporation. All rights reserved worldwide. All other trademarks and registered trademarks are the property of their respective owners.

Part Number

90940015 Revision H

Revision History

Revision	Date	Description
A	June 2006	Initial release.
B	September 2007	Added support for up to eight frames.
C	December 2008	Specification updates.
D	September 2009	New template, general cleanup.
E	May 2012	New template, corrections, and updates.
F	July 2012	Added bulk TAP.
G	April 2013	Added T950B.
H	March 2015	Updated trademarks and grounding requirements.

- Notes:**
- To make sure you have the most current version of this guide check the Spectra Logic Technical Support portal at support.spectralogic.com/documentation/user-guides/.
 - To make sure you have the release notes for the most current version of the BlueScale software, check the Spectra Logic Technical Support portal at support.spectralogic.com/documentation/release-notes/.

End User License Agreement

You have acquired a Spectra product that includes software owned or licensed by Spectra Logic from one or more software licensors (“Software Suppliers”). Such software products, as well as associated media, printed materials and “online” or electronic documentation (“SOFTWARE”) are protected by copyright laws and international copyright treaties, as well as other intellectual property laws and treaties.

If you do not agree to this end user license agreement (EULA), do not use the Spectra product; instead, promptly contact Spectra Logic for instructions on return of the Spectra product for a refund. Any use of the Software, including but not limited to use on the Spectra product, will constitute your agreement to this EULA (or ratification of any previous consent).

Grant of License. The Software is licensed on a non-exclusive basis, not sold. This EULA grants you the following rights to the Software:

- You may use the Software only on the Spectra product.
- **Not Fault Tolerant.** The Software is not fault tolerant. Spectra Logic has independently determined how to use the Software in the Spectra product, and suppliers have relied upon Spectra Logic to conduct sufficient testing to determine that the Software is suitable for such use.
- **No Warranties for the SOFTWARE.** The Software is provided “AS IS” and with all faults. The entire risk as to satisfactory quality, performance, accuracy, and effort (including lack of negligence) is with you. Also, there is no warranty against interference with your enjoyment of the Software or against infringement. If you have received any warranties regarding the SOFTWARE, those warranties do not originate from, and are not binding on Software suppliers.
- **Note on Java Support.** The Software may contain support for programs written in Java. Java technology is not fault tolerant and is not designed, manufactured, or intended for use of resale as online control equipment in hazardous environments requiring fail-safe performance, such as in the operation of nuclear facilities, aircraft navigation or communications systems, air traffic control, direct life support machines, or weapons systems, in which the failure of Java technology could lead directly to death, personal injury, or severe physical or environmental damage.
- **No Liability for Certain Damages.** Except as prohibited by law, Software suppliers shall have no liability for any indirect, special, consequential or incidental damages arising from or in connection with the use or performance of the Software. This limitation shall apply even if any remedy fails of its essential purpose. In no event shall Software suppliers, individually, be liable for any amount in excess of U.S. two hundred fifty dollars (U.S. \$250.00).
- **Limitations on Reverse Engineering, Decompilation, and Disassembly.** You may not reverse engineer, decompile, or disassemble the Software, except and only to the extent that such activity is expressly permitted by applicable law notwithstanding this limitation.
- **Software Transfer Allowed with Restrictions.** You may permanently transfer rights under this EULA only as part of a permanent sale or transfer of the Spectra product, and only if the recipient agrees to this EULA. If the Software is an upgrade, any transfer must also include all prior versions of the Software.
- **Export Restrictions.** Export of the Software from the United States is regulated by the Export Administration Regulations (EAR, 15 CFR 730-744) of the U.S. Commerce Department, Bureau of Export Administration. You agree to comply with the EAR in the export or re-export of the Software: (i) to any country to which the U.S. has embargoed or restricted the export of goods or services, which as May 1999 include, but are not necessarily limited to Cuba, Iran, Iraq, Libya, North Korea, Sudan, Syria, and the Federal Republic of Yugoslavia (including Serbia, but not Montenegro), or to any national or any such country, wherever located, who intends to transit or transport the Software back to such country; (ii) to any person or entity who you know or have reason to know will utilize the Software or portion thereof in the design, development or production of nuclear, chemical, or biological weapons; or (iii) to any person or entity who has been prohibited from participating in U.S. export transactions by any federal agency of the U.S. government. You warrant and represent that neither the BXA nor any other U.S. federal agency has suspended, revoked or denied your export privileges.

A document listing all warnings found in Spectra Tape Libraries documentation, in English and 27 other languages, is available on the Spectra Logic website at support.spectrallogic.com/documentation.



WARNING

Library frames are very heavy (see product specifications for details). Use extreme caution and proper equipment when moving these, and ensure that your floor has adequate structural integrity.



WARNING

Line voltage exists at these connectors.

Only qualified personnel should attempt to conduct this test.

Use extreme caution when taking measurements.



WARNING

Boxed and unboxed library components weigh from 200 to 400 pounds each (91 to 181 kg) or more. Use extreme caution and proper equipment when moving these.



WARNING

The ties around the shipping crates are secured very tightly; the tension may cause them to whip outward when cut. Use care when cutting the ties so that you will not be hit.

Contacting Spectra Logic

To Obtain General Information

Spectra Logic Website: www.spectralogic.com

United States Headquarters

Spectra Logic Corporation
6285 Lookout Road
Boulder, CO 80301
USA

Phone: 1.800.833.1132 or 1.303.449.6400

International: 1.303.449.6400

Fax: 1.303.939.8844

European Office

Spectra Logic Europe Ltd.
Venture House
Arlington Square, Downshire Way
Bracknell, RG12 1WA
United Kingdom

Phone: 44 (0) 870.112.2150

Fax: 44 (0) 870.112.2175

Spectra Logic Technical Support

Technical Support Portal: support.spectralogic.com

United States and Canada

Phone:

Toll free US and Canada: 1.800.227.4637

International: 1.303.449.0160

Europe, Middle East, Africa

Phone: 44 (0) 870.112.2185

Deutsch Sprechende Kunden

Phone: 49 (0) 6028.9796.507

Email: spectralogic@stortrec.de

Mexico, Central and South America, Asia, Australia, and New Zealand

Phone: 1.303.449.0160

Spectra Logic Sales

Website: www.spectralogic.com/shop

United States and Canada

Phone: 1.800.833.1132 or 1.303.449.6400

Fax: 1.303.939.8844

Email: sales@spectralogic.com

Europe

Phone: 44 (0) 870.112.2150

Fax: 44 (0) 870.112.2175

Email: eurosales@spectralogic.com

To Obtain Documentation

Spectra Logic Website: support.spectralogic.com/documentation

Contents

About This Guide	7
INTENDED AUDIENCE	7
RELATED INFORMATION	7
Chapter 1 – Library Overview	10
FRONT PANEL COMPONENTS	11
MAIN AND DRIVE FRAME EXPANSION REAR COMPONENTS	13
BULK TAP EXPANSION FRAME	14
MEDIA EXPANSION FRAMES	14
LIBRARY CAPACITY	14
Chapter 2 – Site Requirements	16
PHYSICAL REQUIREMENTS	16
Data Center Flooring	16
Space Requirements	18
Power Requirements	22
NETWORK CABLING REQUIREMENTS	27
ENVIRONMENTAL REQUIREMENTS	29
Chapter 3 – Preparing for Installation	31
RECEIVING AND STORING THE LIBRARY	32
Acclimating the Library	32
UNPACKING AND MOVING THE LIBRARY	33
Structural Integrity of Flooring	33
Required Equipment	33
Clearances	34
Tilting	34
MOVING THE LIBRARY AFTER INSTALLATION	35
Site Preparation Checklist	36

ABOUT THIS GUIDE

This guide describes site preparation requirements and guidelines for the installation of a Spectra® T950B library. Unless otherwise specified, the requirements for both T950 and T950B libraries are the same and “T950” is used to refer to both. Where they are different, you can find the information for a T950 library in the *Spectra T950 Library User Guide*. This guide includes precautions for safety and handling, as well as facility requirements for the library’s environment, cabling, and placement. It also provides a checklist that you can use to help ensure that your site is prepared before your library arrives.

INTENDED AUDIENCE

This guide is intended for data center administrators preparing a site for a T950 library installation. It provides reference information for facility managers, electricians, IT professionals, and other specialists who will have roles in preparing the site.

RELATED INFORMATION

This section contains information about this document and other documents related to the library and its drives.

Spectra T950 Library

This guide and the following documents related to the Spectra T950B Library are available as PDF files on the Spectra Logic website at: support.spectralogic.com/documentation.

- The *Spectra T950 Library User Guide* describes how to configure, use, maintain, and troubleshoot the library. It also provides specifications for the library.
- The *Spectra T950 Library Quick Reference Guide* provides a quick reference for the user interface and instructions for performing day-to-day library operations such as powering on and off, and preparing, importing, and exporting media.

- The *Spectra T950 Library BlueScale Toolbar Option Map* provides a quick reference for locating the options and commands available through the BlueScale user interface.
- The *Spectra BlueScale Vision Camera User Guide* provides detailed information about installing and using the white BlueScale Vision Camera and software.
- The *Vivotek FD8361 Fixed Dome Network Camera User's Manual* provides detailed information about installing and using the black BlueScale Vision Camera and software.
- The *Spectra Tape Libraries Encryption User Guide* provides detailed information about using BlueScale Encryption Standard and Professional Edition and the Spectra TKLM Encryption key management system. It also provides useful information about encryption best practices and recycling encrypted media.
- The *Spectra Tape Libraries SCSI Developer's Guide* provides detailed information about the SCSI and Fibre Channel commands used in the library.
- The *Spectra Tape Libraries XML Command Reference* provides detailed information about using the XML interface with the T950 library.
- The *Spectra Tape Libraries Warnings* document provides all of the warnings found in Spectra tape libraries documentation, in English and 27 other languages.

The following document is available after logging into your Support portal account at: support.spectralogic.com.

- The *T950 Library Release Notes and Documentation Updates* provides the most up-to-date information about the T950, drives, and media.

LTO Ultrium Tape Drives

The following documents provide information that is applicable to all IBM LTO tape drives.

- *IBM Tape Device Drivers Installation and User's Guide*
Note: This guide also provides information about using the IBM Tape Diagnostic Tool (ITDT) to troubleshoot drive problems.
- *IBM TotalStorage LTO Ultrium Tape Drive: SCSI Reference* (LTO-1 through LTO-4)
- *IBM TotalStorage LTO Ultrium Tape Drive: SCSI Reference* (LTO-5 and LTO-6)

For drive-specific information, search for the product name (for example, LTO 5) on the documentation page on the IBM website. You can also search the IBM Support Portal at:

<http://www-947.ibm.com/support/entry/portal/Documentation>.

TS11x0 Technology Drives

The following documents provide information that is applicable to TS11x0 technology drives.

- [IBM System Storage Tape Drive 3592 SCSI Reference](#)
- [IBM Tape Device Drivers Installation and User's Guide](#)

Note: This guide also provides information about using the IBM Tape Diagnostic Tool (ITDT) to troubleshoot drive problems.

Spectra TKLM Server

For additional information that can assist you during the installation and configuration of your server, see the following websites:

- [IBM Tivoli Key Lifecycle Manager Information Center](#)
- [Tivoli Key Lifecycle Manager Installation and Configuration Guide](#)

Typographical Conventions

This document uses the following conventions to highlight important information:

Note: Read text marked with “Note” for additional information or suggestions about the current topic.



Important

Read text marked by the “Important” icon for information that will help you complete a procedure or avoid extra steps.



Caution

Read text marked by the “Caution” icon for information you must know to avoid damaging the library or the tape drives, or losing data.



WARNING

Read text marked by the “Warning” icon for information you must know to avoid personal injury.

This document uses an arrow (→) to describe a series of menu selections. For example:

Select **Configuration** → **Partitions** → **New**.

— means —

Select **Configuration**, then select **Partitions**, and then select **New**.

CHAPTER 1

Library Overview

The Spectra T950 enterprise-class libraries are designed and built to meet the stringent requirements for data integrity, data security, and high reliability in the enterprise environment.

The following sections provide an overview of the library components. Depending on the options you ordered, some of the components shown may not be included in your library. For detailed descriptions of the library components and media, read the Library Overview chapter in the *Spectra T950 Library User Guide* for your library.

The library will be installed by a certified Spectra Logic field engineer. The information in the following sections is provided for your reference only. This document is not an installation guide.

Topic	
Front Panel Components	page 11
Main and Drive Frame Expansion Rear Components	page 13
Bulk TAP Expansion Frame	page 14
Media Expansion Frames	page 14
Library Capacity	page 14

FRONT PANEL COMPONENTS

Figure 1 shows the front components of a multi-frame T950B library and Figure 2 on page 12 shows a T950 library. The figures also show the relative locations of the main frame and the expansion frames. T950B main frames have a centered center TAP and operator panel; T950 main frames have an offset center TeraPack® Access Port (TAP) and operator panel. T950B media expansion frames do not have a filter on the front at the bottom; T950 media expansion frames do.

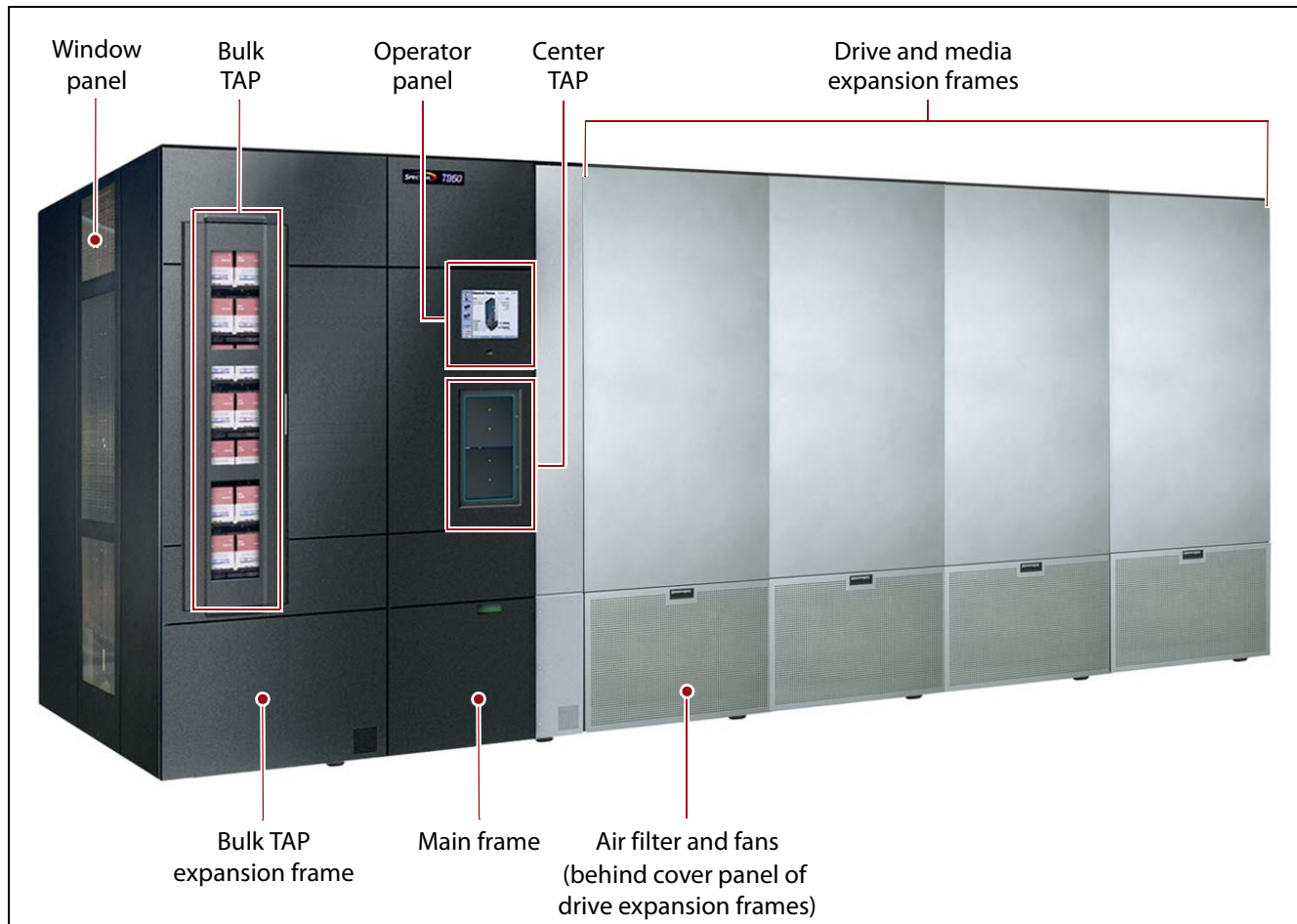

Figure 1 T950B library with optional bulk TAP expansion frame.

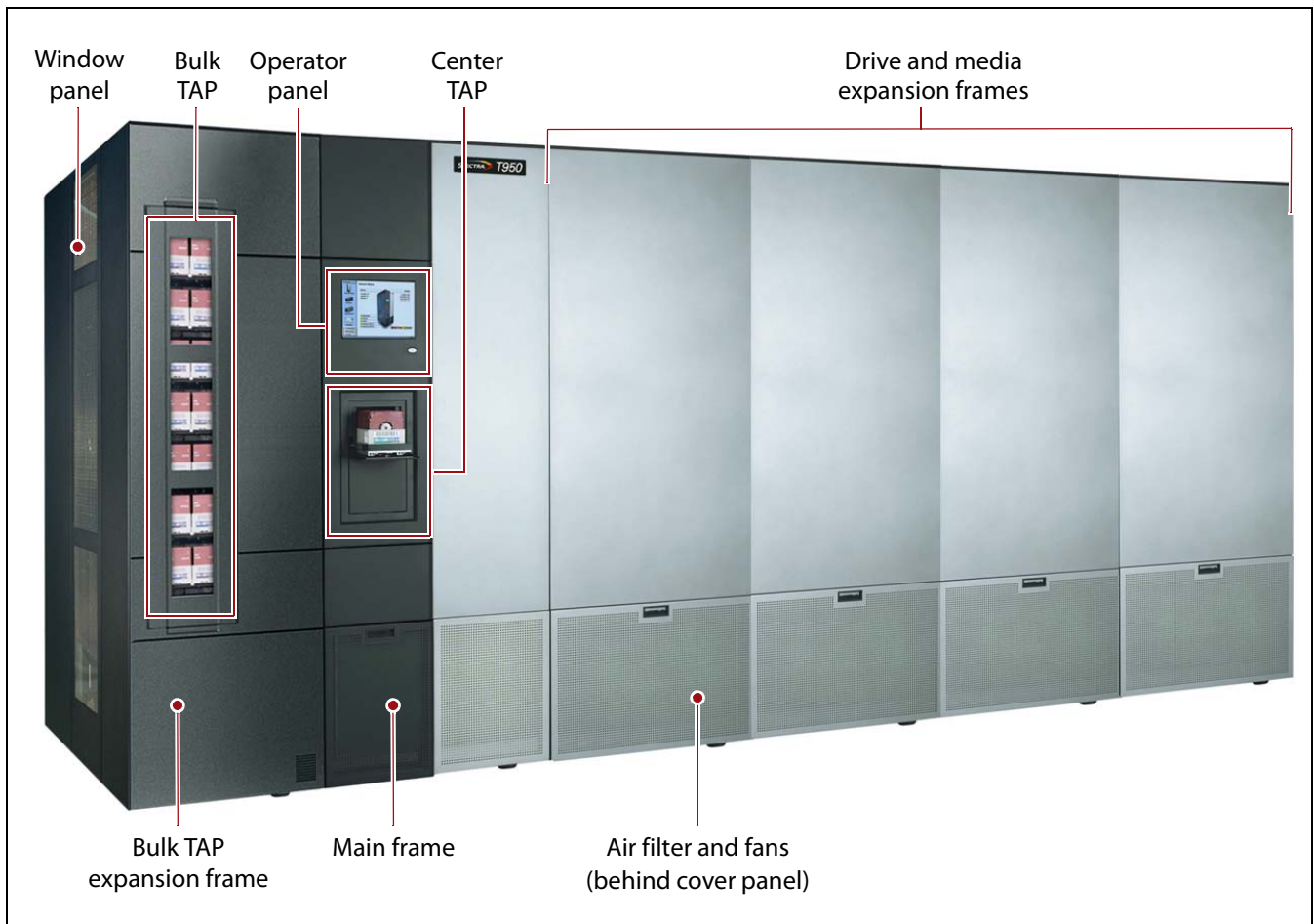

Figure 2 T950 library with optional bulk TAP expansion frame.

MAIN AND DRIVE FRAME EXPANSION REAR COMPONENTS

Figure 3 shows the rear panel components of the library's main and drive expansion frames.

Note: Any bays that do not contain components have covers installed to maintain proper air circulation through the library.

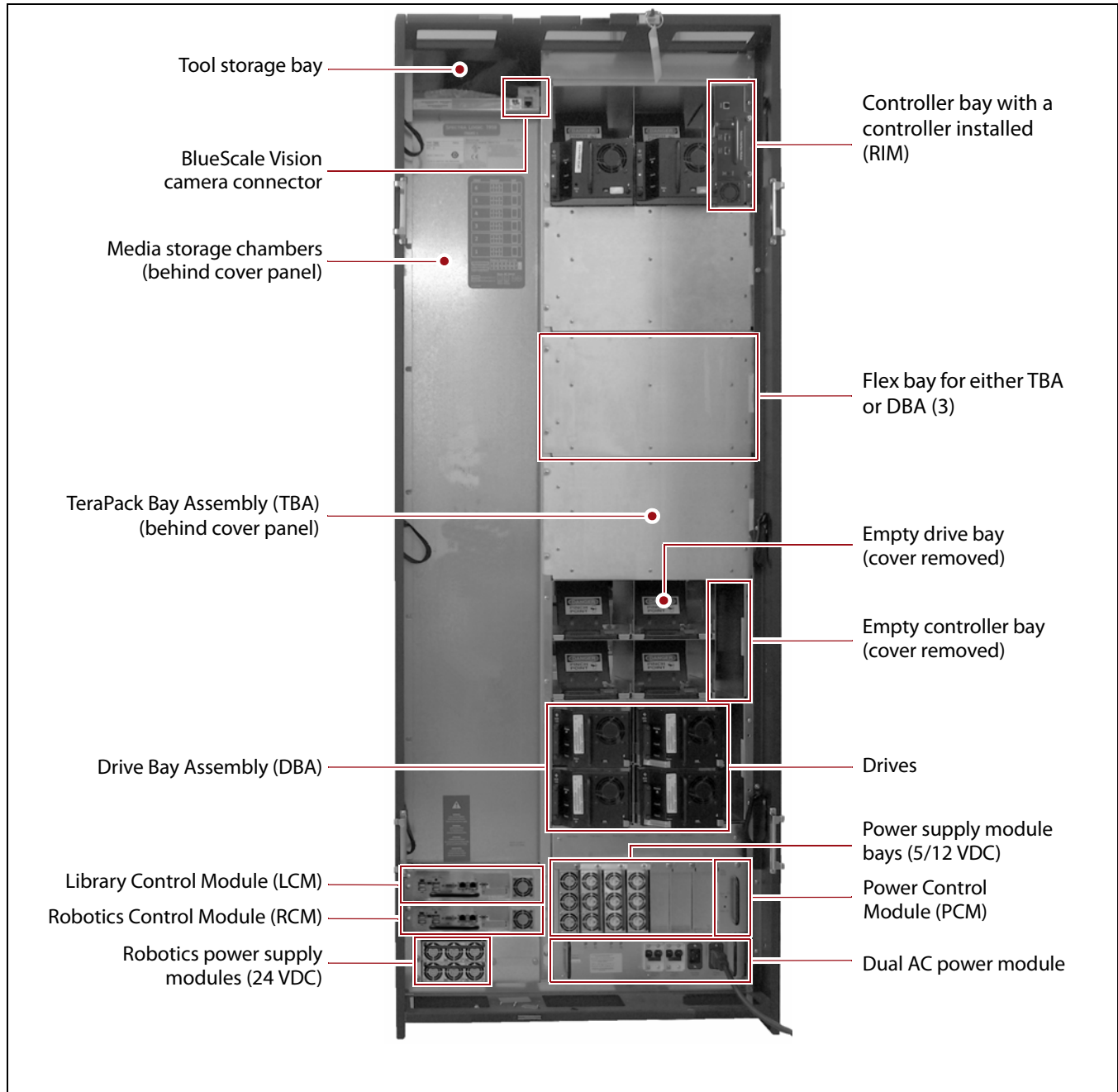

Figure 3 Library rear components (main frame, doors removed).

BULK TAP EXPANSION FRAME

The bulk TeraPack Access Port (bulk TAP) expansion frame is used to import or export up to 14 magazines in a single operation.

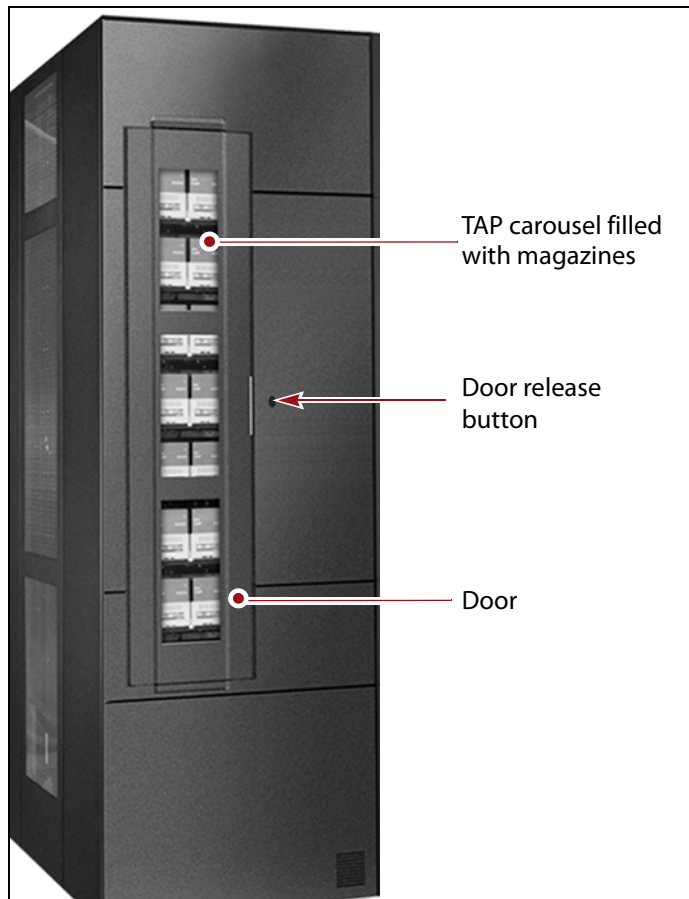

Figure 4 The front of the bulk TAP media frame.

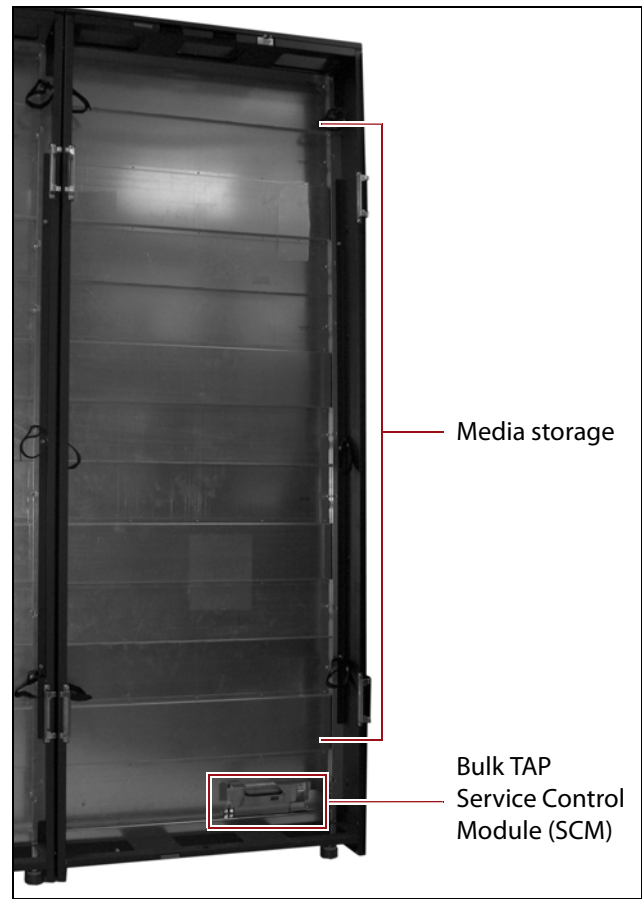

Figure 5 The back of the bulk TAP media frame (doors removed).

MEDIA EXPANSION FRAMES

Media expansion frames are for media storage only and do not include any active front or rear panel components.

LIBRARY CAPACITY

The T950's modular design makes it possible to increase media capacity or the number of drives in the library to meet storage and performance needs as they evolve. Expansion frames can be added to the basic single-frame library for a maximum of eight frames.

The following table shows the number of media storage chambers, slots, and drives in each type of frame in the T950.

Frame Type	Number of Chambers ^a	Number of slots	Maximum Number of Drives
LTO Library			
T950 main			
▪ 3 DBAs/3 TBAs	95	950	12
▪ 6 DBAs	83	830	24
T950B main			
▪ 1 DBA/shelves	100	1000	4
▪ 3 DBAs/3 TBAs or shelves	92	920	12
▪ 6 DBAs	80	800	24
T950B main with a bulk TAP			
▪ 1 DBA/shelves	110	1100	4
▪ 3 DBAs/3 TBAs or shelves	98	980	12
▪ 6 DBAs	80	800	24
Drive expansion (optional)			
▪ 3 DBAs/3 TBAs	101	1010	12
▪ 3 DBAs/shelves	107	1070	12
▪ 6 DBAs	89	890	24
Media expansion (optional)	130	1300	None
Bulk TAP expansion (optional)	91	910	None
TS11x0 Technology Library			
T950B main			
▪ 1 DBA/shelves	82	738	4
▪ 3 DBAs/shelves	76	684	12
▪ 6 DBAs/shelves	66	594	24
T950B main with a bulk TAP			
▪ 1 DBA/shelves	90	810	4
▪ 3 DBAs/shelves	81	729	12
▪ 6 DBAs/shelves	66	594	24
Drive expansion (optional)			
▪ 3 DBAs/shelves	90	810	12
▪ 6 DBAs	75	675	24
Media expansion (optional)	110	990	None
Bulk TAP expansion (optional)	77	693	None

a. A single magazine is stored in each chamber. Each LTO magazine contains 10 slots. Each TS11x0 technology magazine contains 9 slots.

CHAPTER 2

Site Requirements

This chapter describes the site requirements for the library. Make sure that the location where the library will be installed meets these requirements before the Spectra Logic field engineer arrives to install the library.

Topic	
Physical Requirements	this page
Data Center Flooring	page 16
Space Requirements	page 18
Power Requirements	page 22
Network Cabling Requirements	page 27
Environmental Requirements	page 29

PHYSICAL REQUIREMENTS

The following physical requirements apply to the location where the library will be installed. Meeting these requirements sets the necessary parameters for successfully operating the library, as well as ensuring adequate clearances for, maintenance access to, and expansion of the library.

Data Center Flooring

The flooring where you plan to install the library is an important part of the installation and operation planning. Make sure that it has adequate structural integrity to handle the weight and leveling requirements of the library.



WARNING

Library frames are very heavy (see product specifications for details). Use extreme caution and proper equipment when moving these, and ensure that your floor has adequate structural integrity.

Library Weight The following table shows the size and weight specifications for the library frames and other components.

- All dimensions and weights are approximate.
- To calculate the approximate weight of a loaded library, calculate the total weight for all of the frames and then add the weight for each drive, RIM, and power supply, plus the weight of each TeraPack magazine full of cartridges.
- To calculate the dimensions of the entire library, total the dimensions for each frame and add 1.625 inches to account for the outer cover panels on each side of the library.
- When calculating space requirements, include the service access requirements described in [Space Requirements on page 18](#), below.

Parameter	Main Frame	Drive Expansion Frame	Media Expansion Frame	Bulk TAP Media Expansion Frame
Height ^a	79.125 to 82 in. (201.0 to 208.3 cm)			
Width ^b	29 in. (73.7 cm)			
Depth ^c	43.25 in. (109.9 cm)			
Weight ^d	<ul style="list-style-type: none"> ▪ T950 6D0T: 954 lb (433 kg) 3D3T: 933 lb (423 kg) ▪ T950B 6D0T: 895 lb (406 kg) 3D3T: 876 lb (397 kg) 	<ul style="list-style-type: none"> 6D0T: 720 lb (327 kg) 3D3T: 750 lb (340 kg) 	<ul style="list-style-type: none"> ▪ T950 547 lb (248 kg) ▪ T950B 538 lb (244 kg) 	800 lb (363 kg)
Each tape drive	<ul style="list-style-type: none"> ▪ LTO-2 through LTO-4: 11.5 lb (5.2 kg) ▪ LTO-5 and LTO-6: 11.6 lb (5.3 kg) ▪ TS11x0 technology: 17.5 lb (8 kg) 		N/A	
Each TeraPack magazine	<ul style="list-style-type: none"> ▪ with ten LTO cartridges: 5.1 lb (2.3 kg) ▪ with nine TS11x0 technology cartridges: 5.6 lb (2.5 kg) 			
Each RIM	5.0 lb (2.3 kg)		N/A	
Each power supply	4.0 lb (1.8 kg)		N/A	
Fully loaded maximum weight	<ul style="list-style-type: none"> ▪ T950 6D0T: 1,722 lb (781 kg) 3D3T: 1,608 lb (729 kg) ▪ T950B 6D0T: 1,648 lb (748 kg) 3D3T: 1,535 lb (696 kg) 	<ul style="list-style-type: none"> 6D0T: 1,510 lb (685 kg) 3D3T: 1,447 lb (656 kg) 	<ul style="list-style-type: none"> ▪ T950 1,210 lb (549 kg) ▪ T950B 1,201 lb (545 kg) 	1,335 lb (606 kg)

a. The height of each frame can be adjusted to allow frame-to-frame leveling on uneven floors.

b. These dimensions represent the frames without the side cover panels installed. The outermost frame on each end of the library has a single side cover panel. Each side cover panel adds 1 inch to the width of the frame.

c. These dimensions represent the frames with the front and back cover panels installed.

d. These weights are with no drives, RIMs, power supplies, or media installed.

Data center floors may require reinforcement to hold the library's weight. Check your site's flooring for load-bearing specifications.

**Caution**

Spectra Logic is not responsible for damage caused to the library or its surroundings if the floor is not adequately reinforced. Inadequate floor reinforcement can allow the library to sag, causing misalignment of the frames and robotic motion failures.

Weight-Distribution Plates If you would like to install the library on a weight-distributing plates, Spectra Logic recommends steel plates with the minimum dimensions of 36 x 30 x 0.25 inches (91.4 x 76.2 x 0.6 cm). Plates should be placed under the feet at the front and back of each frame junction and under the outer feet of the right-most and left-most frames of a multi-frame library.

Note: After determining the positions for the plates, attach them to the floor to prevent them from moving as you roll the frames into place.

Flooring Type The floor where the library is to be installed must be level, and must be hard flooring, such as cement or tile—do not install the library on carpeting. This requirement is particularly important when installing a multi-frame library, because all frames must be precisely aligned. Carpeting also increases the risk of static discharge when operating the library.

**Caution**

The library must be installed on a level, hard-surfaced floor such as cement or tile.

A small amount of floor unevenness can be compensated for using the levelers on each library frame.

Space Requirements

Library Frames Placement

The bulk TAP, if present, must always be the left-most frame as viewed from the front of the library. The main frame must be positioned as the left-most frame or the frame immediately to the right of the bulk TAP. Up to four drive expansion frames can be located immediately to the right of the main frame. Media frames can be located to the right of the main frame and any drive frames. A maximum of eight frames is allowed.

Space Planning and Service Access Requirements

Recommended Clearance Providing 3 ft (0.9 m) of clearance on each side of the library is highly recommended.

T950B Minimum Clearance A minimum of 2 ft (0.6 m) of clearance is required on the left and right ends of the library to provide service access to the library. If data center equipment is on rolling racks and can be easily moved to provide 2 ft (0.6 m) of clearance on each end of the library, then having equipment adjacent to the ends of the library is acceptable. In addition, a minimum of 2 ft (0.6 m) of clearance at the front and back of the main frame, each drive expansion frame, and the bulk TAP frame is required for airflow and for service and operator access.



Important

Providing 3 ft (0.9 m) of clearance on each side of the library is highly recommended.

Single-Frame Library Figure 6 shows the total space required for a single-frame library, including the recommended access clearance.

Note: All dimensions are rounded to the nearest tenth.

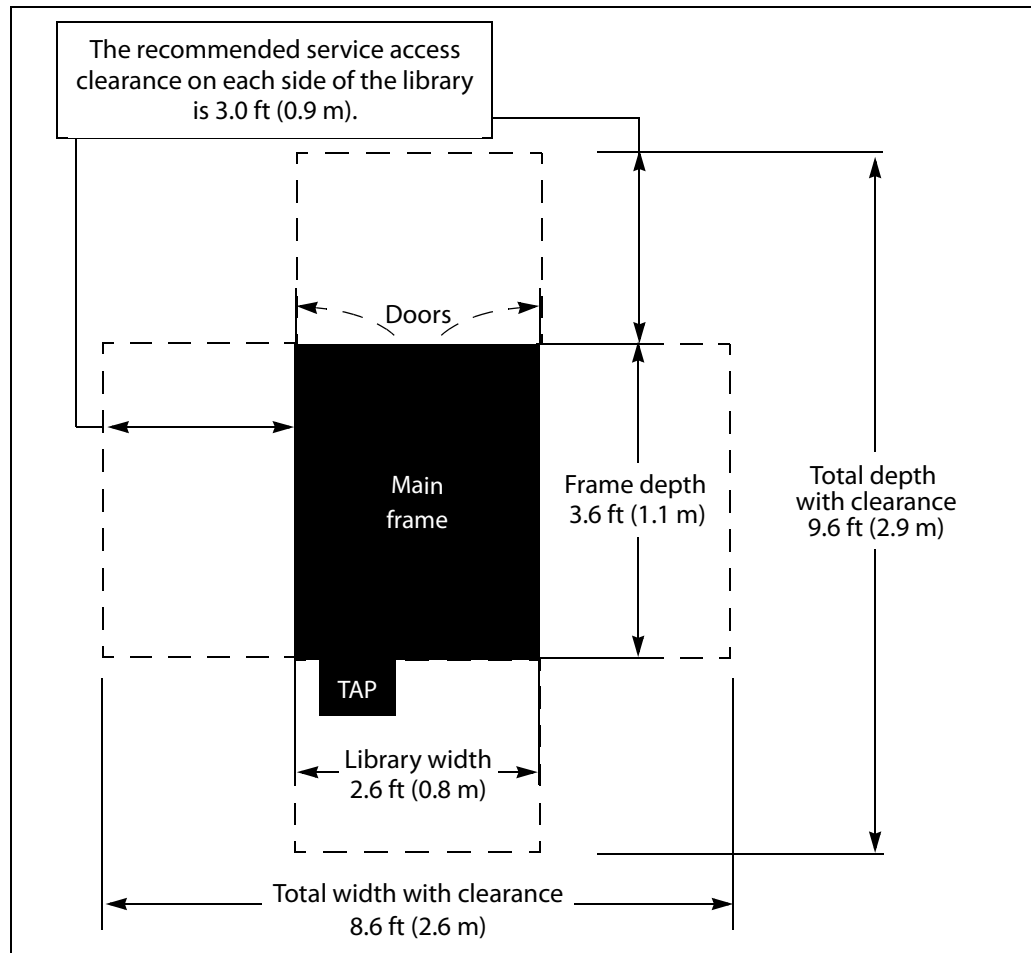

Figure 6 Dimensions of a single-frame T950, including recommended service access clearance.

Multi-Frame T950 Library Figure 7 shows the total space required for an eight-frame library, including the recommended access clearance.

Note: All dimensions are rounded to the nearest tenth.

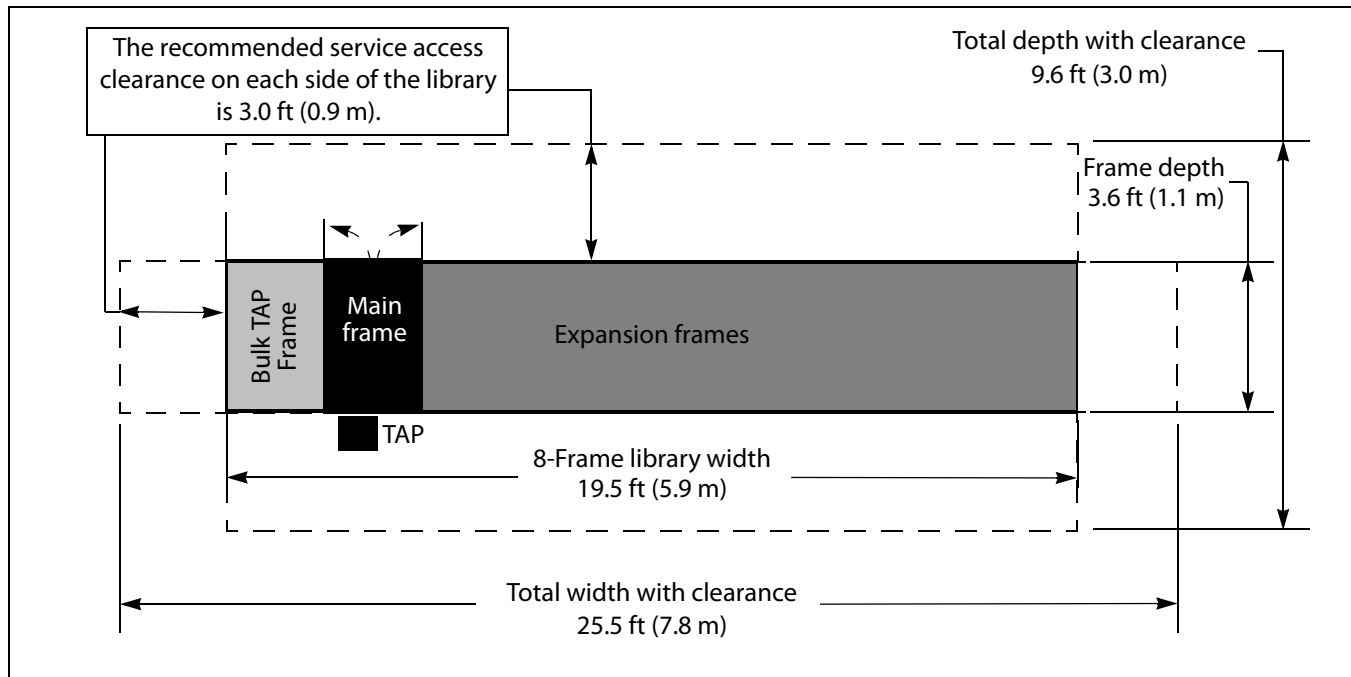

Figure 7 Dimensions of the eight-frame T950, including recommended service access clearance.

The following table shows the width of a T950 library, including the recommended 3 ft (0.9 m) access clearance on each end of the library. The depth of all libraries, including access clearance, is 9.6 ft (3.0 m).

Number of Frames	Library Width ^a	Total Recommended Access Width ^a
One Frame	2.6 ft (0.8 m)	8.6 ft (2.6 m)
Two Frames	5.0 ft (1.5 m)	11.0 ft (3.3 m)
Three Frames	7.4 ft (2.3 m)	13.4 ft (4.1 m)
Four Frames	9.8 ft (3.0 m)	15.8 ft (4.8 m)
Five Frames	12.2 ft (3.7 m)	18.2 ft (5.5 m)
Six Frames	14.6 ft (4.5 m)	20.6 ft (6.3 m)
Eight Frames	19.5 ft (5.9 m)	25.5 ft (7.8 m)

a. All dimensions are rounded to the nearest tenth.

Floor and Ceiling Cable Access

Figure 8 and Figure 9 on page 21 provide the dimensions for cable access holes for main and drive expansion frames. See Figure 11 on page 27 to see the location of these access holes in a frame. The dimensions are different for the floor and ceiling access holes. Be sure to consider the structural integrity of the floor before cutting holes in the floor for access.



WARNING

Library frames are very heavy (see product specifications for details). Use extreme caution and proper equipment when moving these, and ensure that your floor has adequate structural integrity.

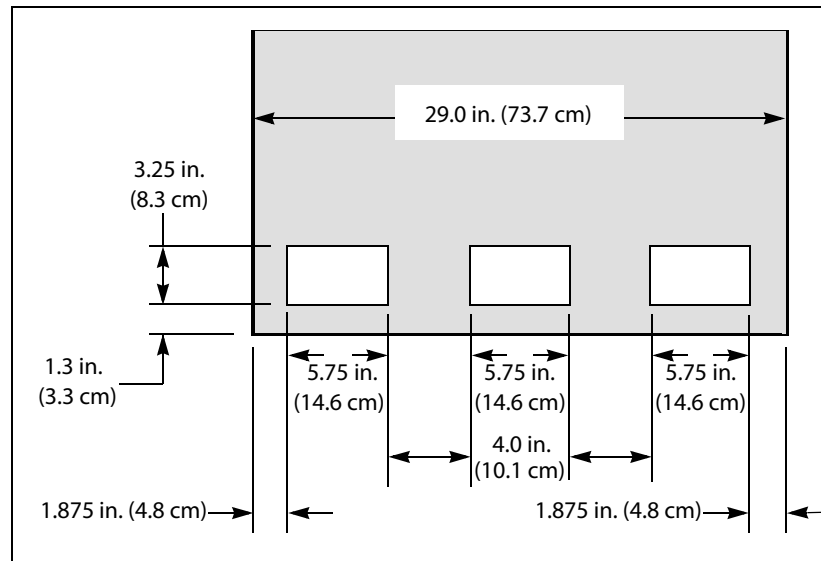

Figure 8 Ceiling cable access for main and drive expansion frames.

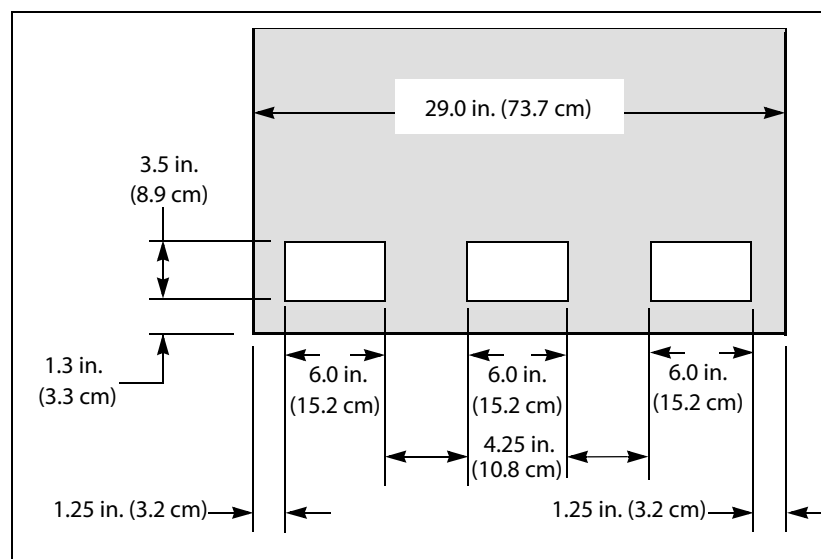

Figure 9 Floor cable access for main and drive expansion frames.

Power Requirements

This section provides an overview of the power requirements for the library. All electrical cabling must be completed *before* beginning the library installation.

**Caution**

Failure to meet the cabling and power specifications could damage your library, result in data loss, or both.

Power Input The main frame and the drive expansion frames include dual AC power inputs. When using a redundant power configuration, connect each input to a separate branch circuit, which allows for failover in the event of a power failure in one of the circuits.

To prevent problems switching between two AC power sources in a redundant AC power configuration, the two AC inputs for each frame must be on the same phase. Different frames can be on different phases.

**Caution**

If the power sources for the dual AC inputs for a frame are not on the same phase, damage to the library could result.

Also, the voltages of the two AC power sources must be the same within a few volts. To ensure that this requirement is being met, measure the voltages between the pins of the two input cables (IEC 60320-C19).

**WARNING**

Line voltage exists at these connectors.

Only qualified personnel should attempt to conduct this test.

Use extreme caution when taking measurements.

The two top pins are voltage inputs. The bottom pin is ground. As shown in [Figure 10](#), the top input voltage pins are labeled A and B, from left to right, and the bottom pins are labeled C. Confirm the following measurements:

- The voltage from A to A or B to B should be less than 4 V.
- The voltage from A to B or B to A should be between 200 and 240 V.
- The voltage between any A or B pin to either C pin should be about 120 V.

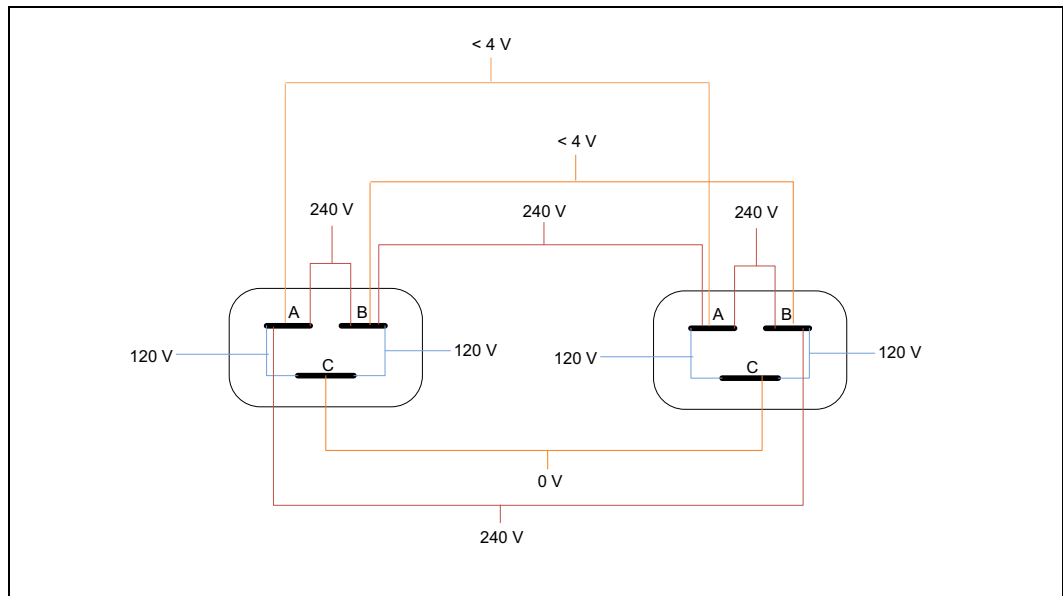

Figure 10 Dual AC input voltage requirements.

Each library frame is rated at 200–240 VAC at 13 amps (2600 watts maximum). This power rating is based on a main frame with 24 LTO drives and 6 RIMs, which is the configuration for maximum power consumption by a single frame. The frames are *not* rated at 120 VAC due to the high current required to supply the product.

Grounding Requirements Due to electromagnetic interference (EMI) filtering in each dual AC power supply, the leakage current for main frames and drive frames is such that they require a secure connection from the chassis of the unit to an earth ground.

Use one or more of the following methods for securing a ground connection when installing a main frame or drive frame:

Note: Cord lock brackets and cords with locking connectors are not compatible and cannot be used simultaneously.

- Add cord lock brackets (Spectra Logic part number 5497) to all drive frames. See “Installing Cord Locks” in the *Spectra T950 Library User Guide* for more information.
- Use a cord with locking connectors at both ends, such as L6 20P to locking C19 (Spectra Logic part number 9594).
- Use a dedicated external ground wire (Spectra Logic part number 91017013) from the chassis screw lug to the building’s earth ground.

Power Cord Specifications The power cords included with the library are considered part of the library and are not intended for use with any other equipment. The power cord must meet the specifications for the country where the library will be installed.



North America and Korea 200–240 VAC Power Cord The criteria for a 200-volt to 240-volt AC power cord in North America and Korea are as follows:

Parameter	Specification
Power cordage	SJT type, three-conductor, 14 AWG minimum
Power input connectors	<ul style="list-style-type: none"> ▪ Male: Connector must be of the proper type, rating, and safety approval (see Supply-End Connector Types on page 25). ▪ Female: IEC 60320 C13

International 200–240 VAC Power Cord The criteria for an international 200-volt to 240-volt AC power cord are as follows:

Parameter	Specification
Power cordage	Flexible, HAR (harmonized) type H05VV-F, three conductor, cord with minimum conductor size of 1.7 square millimeters (0.0026350 square inches).
Power input connectors	<ul style="list-style-type: none"> ▪ Male: Connector must be of the proper type, rating, and safety approval for the intended country (see Supply-End Connector Types on page 25). ▪ Female: IEC 60320 C13

Supply-End Connector Types The supply-end connector on the cord depends on the country where the library will be installed. The following table shows the supply-end connector types used in some countries.

Part Number	Country of Use	Plug Style	Length	Appearance
9594	North America, Korea	NEMA L6-20P	14.8 ft (4.5 m)	
7029	North America, Korea	NEMA L6-30P	14.8 ft (4.5 m)	
6807	Japan	NEMA L6-20P	13.9 ft (4.25 m)	
8665	United Kingdom, Continental Europe	IEC 60309	15 ft (4.6 m)	

Power Outlet Location The twist lock supply-end connector is considered the power disconnect for the unit. The outlet must therefore be installed in an accessible location near the library.

Power Receptacles The power receptacles for the main frame and the drive expansion frames are located in the lower right-hand corner of the frame as you face the back of the library (see [Figure 3](#) on page 13).

The following table shows the number of power receptacles on each frame type.

Frame Type	Number of Power Outlets
Main Frame	2 ^a
Drive Expansion Frame	2 ^a
Media Expansion Frame	0
Bulk TAP Media Frame	0

a. The second connection is the redundant or failover connection.

Power Consumption and Cooling Requirements

The power and cooling requirements for the library depend on the number and type of drives installed. The following table provides the maximum power consumption and heat load for the base library and for each additional component added to the base library. Use this information to calculate the total maximum power consumption and heat load values, which can be used to build a power budget for the library.

All values are measured at the AC input and include power supply efficiency. The values are averages of observed hardware. In general, the lighter the load on the power supplies, the less efficient they are. The power supply efficiency in turn affects the power draw of all components.

Component	Power Consumption (watts)	Heat Load, Continuous (BTU/hour)
Main frame ^a	183	625
Drive frame ^a	139	475
Media frame in frame location 2 through 6	110	376
Media frame in frame location 7 or 8	14	48
Bulk TAP frame	125	427
5/12 VDC power supply	33	113
24 VDC power supply	29	99
RIM	12	41
LTO-6 Fibre Channel	<ul style="list-style-type: none"> ▪ Read/write: 28 ▪ Idle: 8 ^b 	Read/write: 95
LTO-5, Fibre Channel	<ul style="list-style-type: none"> ▪ Read/write: 37 ▪ Idle: 19 ^b 	Read/write: 126
LTO-4, Fibre Channel	<ul style="list-style-type: none"> ▪ Read/write: 37 ▪ Idle: 17.5 ^b 	Read/write: 123
LTO-3, Fibre Channel	<ul style="list-style-type: none"> ▪ Read/write: 29 ▪ Idle: 15 ^b 	Read/write: 99
TS1150 technology	<ul style="list-style-type: none"> ▪ Read/write: 55 ▪ Idle: 38 ^b 	Read/write: 188
TS1140 technology	<ul style="list-style-type: none"> ▪ Read/write: 53 ▪ Idle: 30 ^b 	Read/write: 181

a. Assumes one 5/12 volt power supply and one 24 volt power supply; no drives or RIMs installed.

b. No cartridge loaded.

NETWORK CABLING REQUIREMENTS

The library can accommodate cabling from either the bottom or the top of the library. See [Floor and Ceiling Cable Access](#) on page 21 for additional information.

Use [Figure 11](#) and the descriptions that follow to plan network connectivity for the library installation.

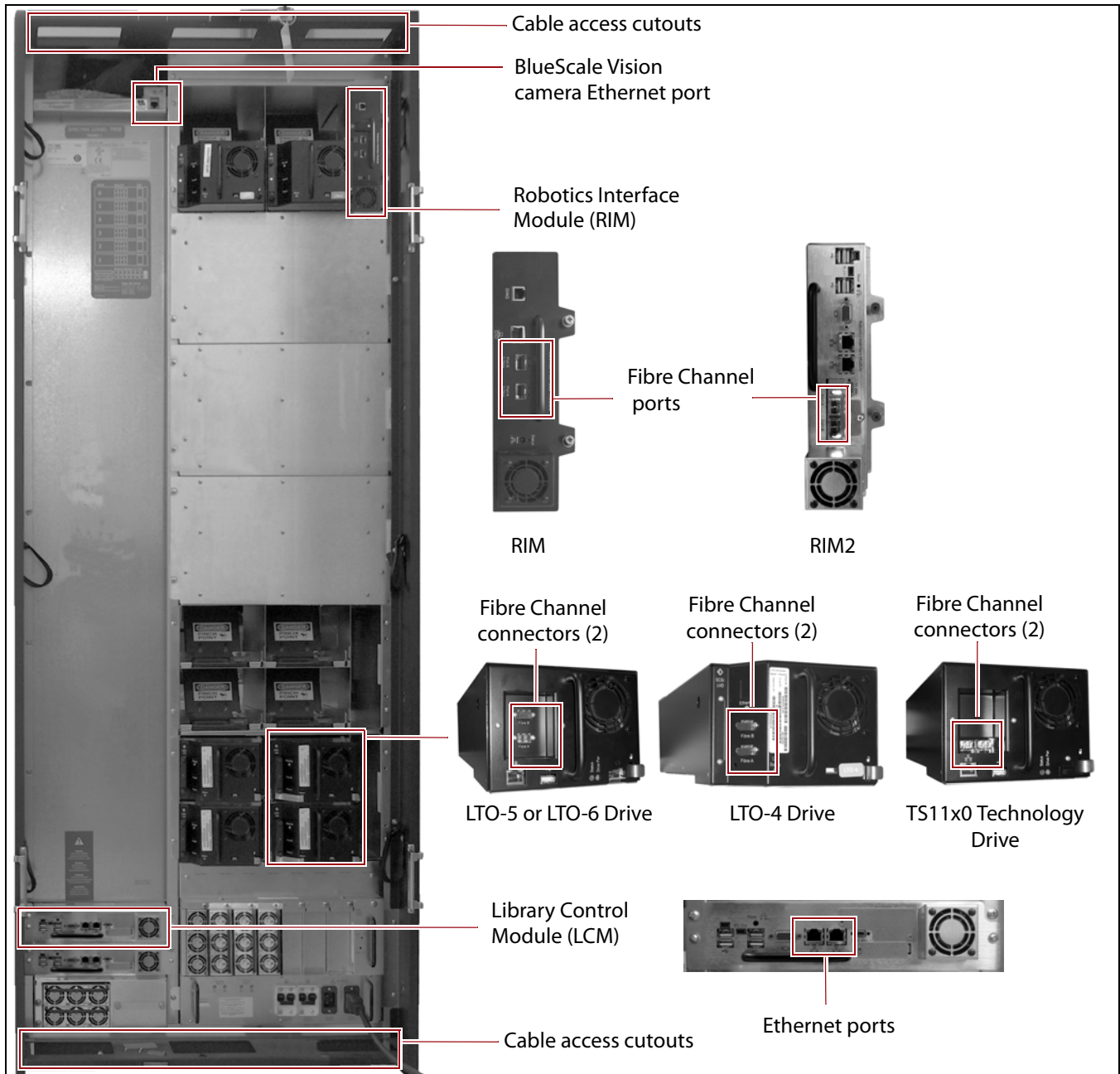

Figure 11 Locations for network cable connections.

Library Access Provide a Category 5 (10/100BaseT connection) data-grade Ethernet cable that is compliant with EIA/TIA 568 from an active Ethernet network. This cable will be connected to an Ethernet port on the LCM for remote access to the library's BlueScale web interface and to allow for the library to automatically email notifications to users and AutoSupport tickets to Spectra Logic Technical Support. During installation, the library's connection is set up with the library's IP address, subnet, proxy server, and other IP configuration settings.



Caution Some port scanning software can interfere with remote library sessions.

Host Access Provide one or two optical fiber cables from the arbitrated loop or switched fabric, to Fibre Channel port(s) on a RIM in each partition to provide the hosts with access to the medium changer. Depending on the wavelength, the cables must comply with the following specifications in the Fibre Channel standard (FC-PI-2):

- **50 micron**—400-M5-SN-I classification
- **62.5 micron**—400-M6-SN-I classification

Tape Drive Access Provide one optical fiber cable from the arbitrated loop or switched fabric, to a Fibre Channel port on each drive, to provide the hosts with access to the drives. Depending on the wavelength, the cables must comply with the following specifications in the Fibre Channel standard (FC-PI-2):

- **50 micron**—400-M5-SN-I classification
- **62.5 micron**—400-M6-SN-I classification (not supported for LTO-6 or TS11x0 technology drives)

The following table can be used to determine the maximum length for an M5 cable.

Data Rate / Link Speed	M5 (OM2) cable	M5E (OM3) cable	M5F (OM4) cable
1 Gbps	1640 ft (500 m)	Not Specified	Not Specified
2 Gbps	984 ft (300 m)	Not Specified	Not Specified
4 Gbps	492 ft (150 m)	1247 ft (380 m)	1312 ft (400 m)
8 Gbps	164 ft (50 m)	492 ft (150 m)	623 ft (190 m)

BlueScale Vision Camera Access One BlueScale Vision camera is included with the main frame. Additional cameras can be installed in the expansion frames. To comply with EMC requirements, provide a shielded Category 5 (10/100BaseT connection) data-grade cable or a similar Category 5 cable from an active Ethernet network to each camera.

ENVIRONMENTAL REQUIREMENTS

The following sections list the general environmental specifications for the library.

Air Flow Air flows through the library from front to back. In data centers using a hot aisle/cold aisle layout, position the library so that the cold aisle is in front of the library (cold air in), and the hot aisle is behind the library (hot air out).

Air Quality Keep the location as free of airborne particulates as possible. To eliminate obvious sources of particulates, do not permit anyone to smoke, eat, or drink near the storage area, and do not place the library near a copier or printer that may emit toner and paper dust.

Temperature, Humidity, and Altitude The library is equipped with internal fans that operate as much as is necessary for the number of DBAs installed. The fans keep the library's internal temperature within specifications as long as the data center environment is within specifications. The following tables outlines the necessary data center and storage area specifications.

Operating Environmental Specification	
Humidity	20% to 80% (non-condensing)
Humidity gradient	Less than 10% per hour
Ambient temperature ^a	LTO: 50° F to 90° F (10° C to 32° C) TS11x0 Technology: 61° F to 90° F (16° C to 32° C)
Maximum temperature change rate ^b	18° F per hour (10° C per hour), non-condensing
Maximum wet bulb temperature	77° F (25° C)
Altitude	Sea level to 10,000 ft (3,048 m)

a. The maximum ambient temperature must not exceed 86° F (30° C) when G2 F-QIPs are installed in the library.

b. The temperature and humidity must be allowed to stabilize in the specified ambient environment for 24 hours.

Storing ^a and Shipping (Non-Operating) Environment Specification	
Humidity	10% to 95% (non-condensing)
Temperature	-40° F to 149° F (-40° C to 65° C)
Altitude	Sea level to 40,000 ft (12,192 m)

a. The library is in its original packaging. The packaging is designed to protect the library from condensation caused by extreme temperature variations of 27° F (15° C) or more. When the library is moved from a cold storage environment to a warm operating environment, it must be acclimated in its packaging for at least 24 hours before opening to prevent serious condensation damage from occurring.

Fire Protection To comply with the OSHA Directive for Fixed Extinguishing Systems (General, 1910.160), the library has a punch-out in the cover for each frame and a corresponding punch-out in the top of each frame for the purpose of attaching a hose or nozzle from your site's fire extinguishing system.



Figure 12 Location of the fire extinguishing system access opening in the top of the library.

Shock and Vibration The library will operate normally after experiencing shock loads as specified in the following table. The operating shock levels indicate how much shock the library can withstand while the enclosed drives are reading and writing data. The non-operating and storage shock levels indicate how much shock the library can withstand when it is not operating. After experiencing this amount of shock, the library will operate normally.

Specification	Operating	Storing and Shipping (Non-Operating Environment) ^a
Shock	2 g pk ½ sine wave for 10 msec (3 axes, 2 shocks per axis, minimum)	2 g pk ½ sine wave for 10 msec (3 axes, 2 shocks per axis, minimum)
Vibration (Swept Sine)	5 Hz – 500 Hz – 5 Hz 5 – 22 Hz, 0.01-inch DA displacement 22 – 500 Hz, 0.25G pk @ ½ octave (minimum three axes)	5 Hz – 500 Hz – 5 Hz 5 – 31 Hz, 0.02-inch DA displacement 31 – 500 Hz, 1G pk @ ½ octave (minimum three axes)
Vibration (Random)	0.5 Grms, 0 – 3000 Hz (single axis)	1 – 200 Hz @ 1.156 Grms. Bottom face only for 60 minutes.

a. Specifications are for the library in its original packaging.

CHAPTER 3

Preparing for Installation

The library will be installed by a certified Spectra Logic field engineer. This chapter outlines the requirements for storing and moving the library and its components. Make sure that you review these requirements carefully. The information is provided to ensure that the installation site meets the necessary requirements *before* the Spectra Logic field representative arrives.

Topic	
Receiving and Storing the Library	page 32
Unpacking and Moving the Library	page 33
Moving the Library After Installation	page 35

**WARNING**

Library frames are very heavy (see product specifications for details). Use extreme caution and proper equipment when moving these, and ensure that your floor has adequate structural integrity.

**WARNING**

Boxed and unboxed library components weigh from 200 to 400 pounds each (91 to 181 kg) or more. Use extreme caution and proper equipment when moving these.

**WARNING**

The ties around the shipping crates are secured very tightly; the tension may cause them to whip outward when cut. Use care when cutting the ties so that you will not be hit.

RECEIVING AND STORING THE LIBRARY

Before the library arrives, make sure that your receiving and storage areas can accommodate the pallet and boxes used to ship the library and its components. The library is shipped in multiple boxes: one for each library frame and others for the library components such as drives, controllers (RIMs), TeraPack magazines, and media. The boxes are shipped on pallets. The following table provides the approximate dimensions and weights of the pallet and boxes used to ship the library.

	Height	Width	Depth	Weight ^a
Crated Frame ^b	7.2 ft (2.2 m)	3.5 ft (1.1 m)	4.6 ft (1.4 m)	1,200 to 1,300 lb (544 to 590 kg)
Crated VAX Column ^c	8 ft (2.1 m)	2.6 ft (0.8 m)	2.1 ft (0.6 m)	200 lb (91 kg)
Crated HAX Rail ^c				
▪ 2-frame	6.1 ft (1.9 m)	2.3 ft (0.7 m)	1.0 ft (0.3 m)	110 lb (50 kg)
▪ 3-frame	7.7 ft (2.3 m)	3.0 ft (0.9 m)	1.4 ft (0.4 m)	150 lb (68 kg)
▪ 5-frame	12.5 ft (3.8 m)	1.8 ft (0.5 m)	0.7 ft (0.2 m)	120 lb (54 kg)
▪ 6-frame	15.0 ft (4.6 m)	1.8 ft (0.5 m)	1.1 ft (0.3 m)	120 lb (54 kg)
▪ 8-frame ^d	7.3 ft (2.2 m)	2.0 ft (0.6 m)	1.4 ft (0.4 m)	85 lb (39 kg)
Component Pallet ^{e, f}	1.8 to 5.0 ft (0.6 to 1.5 m)	3.5 to 14.9 ft (1.1 to 4.6 m)	1.8 to 5.0 ft (0.6 to 1.5 m)	200 to 400 lb (91 to 181 kg)

- The weight does not include drives, media, RIMs, transporter, or power supply modules.
- Each frame is shipped in a separate crate.
- A single frame library ships with the VAX column installed in the frame.
- Shipped in a palletized package rather than a crate.
- Assumes multiple components are shipped together on a single pallet. Components may also be shipped individually.
- The size and weight of the component pallet depends on the number and type of components shipped. To calculate the approximate weight of all the components, add 11.6 lb (5.3 kg) for each LTO drive, 17.5 lb (8 kg) for each TS11x0 drive, 5 lb (2.3 kg) for each full LTO TeraPack magazine, 5.6 lb (2.5 kg) for each full TS11x0 technology TeraPack magazine, 5 lb (2.3 kg) for each RIM, and 4 lb (1.8 kg) for each power supply.

In preparation for the installation, locate the accessory box, which may have shipped and arrived separately from the library. This box contains option activation keys, the library documentation kit, and additional information that you should read before the library is installed. Make sure that you do not lose any of the option activation keys.

Acclimating the Library

Allow time for the library to acclimate to the working environment when you move it from the loading dock.



Caution

When the library is moved from a cold storage environment to a warm operating environment, it must be acclimated in its packaging for at least 24 hours before opening to prevent serious condensation damage from occurring.

UNPACKING AND MOVING THE LIBRARY

The following sections describe the requirements to safely unpack and maneuver library and component crates from storage to their operating location.

**Caution**

Keep all library and components crated while moving them to the data center. If the data center is not able to accommodate the crates, contact Spectra Logic Professional Services in advance of the installation date. See [Contacting Spectra Logic on page 5](#).

Structural Integrity of Flooring

Ensure that all floors that will be traversed can withstand the weights of the crated components shown in [Receiving and Storing the Library on page 32](#).

Required Equipment

Ensure that any equipment used to move the library components can transport the weights shown in [Receiving and Storing the Library on page 32](#).

Level Surfaces A pallet jack or forklift is required to move the crates on a level surface.

Stairways A stair crawler or other special equipment must be used to traverse stairways. A ramp can sometimes be used to traverse one or two stairs.

Clearances

Before moving the library and components to where they will be installed, make sure that you have access to necessary doorways, stairways, hallways, and elevators, as well as adequate clearance to move through them with the equipment.

Note: All lengths are approximate.

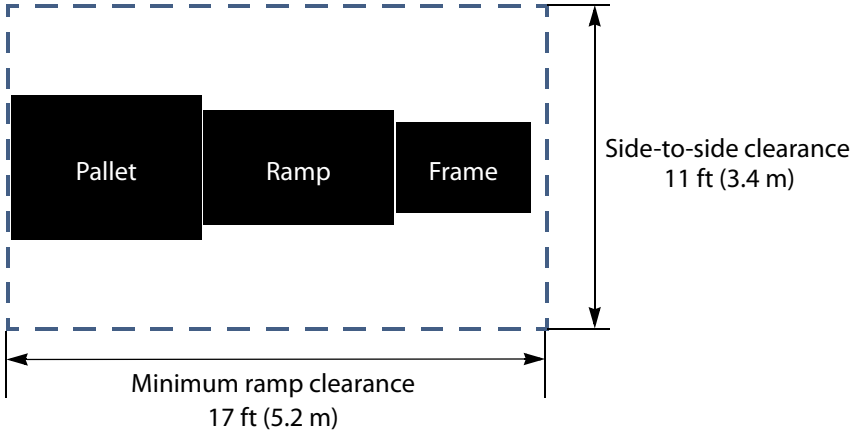
Clearance for...	Requirement
Unpacking	<p>Sufficient space to both remove the library from its packaging and unpack the boxes containing the additional components.</p>  <ul style="list-style-type: none"> ▪ Allow a minimum of approximately 17 ft (5.2 m) on the ramp side of the pallet to unload the library and approximately 4 ft (1.2 m) on each side and above the crate to remove the packaging. ▪ Allow a minimum of 12 ft by 12 ft (3.7 m by 3.7 m) of open space for maneuvering the individual frames from their crates.
Doorways	Doorways (including thresholds) must be taller than 6.7 ft (2 m) and wider than 4 ft (1.2 m).
Stairwell width and height	Stairwells must be taller than 7.5 ft (2.3 m) and wider than 4 ft (1.2 m).
Stairwell and hallway corners	Stairwell and hallway corners should be wider than 5.6 ft (1.7 m).
Elevator width, height, and weight limit	Elevators and elevator doors should be taller than 7.5 ft (2.3 m) and wider than 4 ft (1.2 m). If using an elevator to move the crates, it must be able to accommodate the size and weight of the crates. See Receiving and Storing the Library on page 32 for details.

Tilting

Make sure that you do not tilt the frames from vertical while moving them.



Caution

If you tilt the library, Spectra Logic is not responsible for any damage caused to the library or its components, or for any damage caused to your site.

MOVING THE LIBRARY AFTER INSTALLATION

The library hardware is configured to ensure proper thermal control, air flow, and dust filtering. After the library is installed, do not move the library.

**Important**

Moving the library without assistance from a Spectra Certified Field Engineer will void your service contract. Contact Spectra Logic Professional Services for assistance if you need to relocate your library (see [Contacting Spectra Logic on page 5](#)).

Contact Spectra Logic Technical Support before making any changes to your library hardware or performing any service operations.

Site Preparation Checklist

Use this checklist to ensure that all of the requirements have been met prior to delivery of your library.

Site Requirements	
Data Center Flooring on page 16	
<input type="checkbox"/>	Flooring is hard (not carpeted) and capable of supporting the weight of the library.
<input type="checkbox"/>	Weight distribution plates have been installed (optional).
<input type="checkbox"/>	Flooring is level.
Space Requirements on page 18	
<input type="checkbox"/>	Space is available for the library's height, width, and depth.
<input type="checkbox"/>	Space is available for service and operator access.
<input type="checkbox"/>	Space is available for future growth (optional).
<input type="checkbox"/>	Cables can be routed to the library's cable access areas.
Power Requirements on page 22	
<input type="checkbox"/>	Electrical and peripheral equipment cabling is complete and organized.
<input type="checkbox"/>	Proper number and type of outlets are available at the required locations.
<input type="checkbox"/>	Electrical circuits meet power consumption requirements.
<input type="checkbox"/>	Two separate branch circuits, meeting the power requirements, are available to allow for failover in the event of a power failure in one of the circuits (optional).
Network Cabling Requirements on page 27	
<input type="checkbox"/>	Cabling for remote access to the library's BlueScale web interface is complete and organized.
<input type="checkbox"/>	Cabling for host access to the library is complete and organized.
<input type="checkbox"/>	Cabling for host access to the tape drives is complete and organized.
<input type="checkbox"/>	Cabling for access to the BlueScale Vision Camera(s) is complete and organized.

Environmental Requirements on page 29	
<input type="checkbox"/>	Airflow and air quality meet the library's specifications.
<input type="checkbox"/>	Temperature and humidity are within the library's specifications.
<input type="checkbox"/>	Fire suppression equipment is in place (optional).
<input type="checkbox"/>	Vibration and shock will not exceed the library's specifications.
Preparing for Installation	
Receiving and Storing the Library on page 32	
<input type="checkbox"/>	The receiving/storage area can handle the size and weight of each crated library frame as well as the crate(s) of library components.
<input type="checkbox"/>	The delivery and installation schedule allows 24 hours for the library to acclimate before installation.
Unpacking and Moving the Library on page 33	
<input type="checkbox"/>	Floors to be traversed can handle the weight of the crated frames.
<input type="checkbox"/>	Transportation equipment—forklift, pallet jack, and/or stair crawler—is available and can handle the weight of the crated frames.
<input type="checkbox"/>	Doorways, stairwells, hallways, and elevators allow the size of the crated library without tilting.
<input type="checkbox"/>	Elevators can handle the weight of the crated library.
<input type="checkbox"/>	Space is available in the data center where the library is to be installed for the crates and crate ramp, with extra space for maneuvering.
<input type="checkbox"/>	If the path, transportation equipment, or data center is not able to accommodate the crates, contact Spectra Logic Professional Services in advance of the installation date. See Contacting Spectra Logic on page 5 .