

# Konica

## IP-011

*User's Guide*



*IP Series*

*Print*

*Controller*

Thank you very much for purchasing the IP-011.

This User's Guide includes instructions for making prints, correct handling of the machine, and precautions for safety. Please read this manual before printing.

In order to maintain a satisfactory printing performance, please keep this Guide readily available for reference.

© 2002 by Konica Business Technologies, Inc.

#### MAINTENANCE AGREEMENT

The KONICA IP-011 Workgroup Document System™ will give you many years of trouble-free service. To ensure high quality copying performance and to prevent premature wear and failure of precision parts and components, periodic cleaning and routine adjustments should be scheduled.

We recommend that you contact your service center to discuss the benefits and advantages of Konica's Customer Service Maintenance Agreement and to be shown how a maintenance plan can be tailored to your individual copying needs.

#### NOTICE:

Konica Business Technologies, Inc. has made every effort to ensure that the information in this manual is complete and accurate. However, constant efforts are also being made to improve and update the product. Therefore, Konica Business Technologies, Inc. shall not be liable for errors in this manual or for any consequential damages resulting from the use of this manual. The information contained herein is subject to change without notice.

FEDERAL OR STATE STATUTES MAY PROHIBIT THE COPYING OF CERTAIN DOCUMENTS OR INFORMATION, RESULTING IN FINES OR IMPRISONMENT FOR VIOLATORS.

#### MANUAL PART NUMBER:

OP-IP011-04

#### WEB SITE ADDRESS

<http://www.konicabt.com>

#### CORRESPONDENCE:

Correspondence regarding this manual may be mailed to the address shown below.

Konica Business Technologies, Inc.  
Corporate Publications  
500 Day Hill Road  
Windsor, CT 06095

## **Read before using the equipment**

Thank you very much for purchasing the Konica Print Controller IP-011.

Konica Corp. ("Konica") allows you to use the software attached to the IP-011 only when you agree to its "Software License Agreement." If you do not agree to terms of this agreement, return the software to the distributor from which you purchased it.

## **Software License Agreement**

Carefully read all terms and conditions of the agreement which will be shown during the software installation.

Printed in Japan **KONICA CORPORATION**

# Contents

■ Contents .....	ii
■ Introduction .....	v
■ About Supplied Items .....	vi
■ About this Manual .....	vii
■ System Requirements .....	viii
● Windows .....	viii
● Parallel Port .....	viii
■ Conventions Used in this Manual .....	ix
<b>Chapter 1 Overview .....</b>	<b>1-1</b>
■ Contents of This Chapter .....	1-2
■ Overview of the Print Controller .....	1-3
● IP-011 and Print Engine .....	1-3
● IP-011 Hardware Configuration .....	1-4
● I/O Interface .....	1-4
● Data Flow .....	1-5
● How to Use Memory .....	1-6
● General View .....	1-7
■ About the Printer Tools .....	1-8
● About the Printer Tools .....	1-8
● About the Status Monitor .....	1-8
● About the Control Panel .....	1-8
■ About the Printer Driver .....	1-9
● Compliant OS .....	1-9
<b>Chapter 2 Setup .....</b>	<b>2-1</b>
■ Contents of This Chapter .....	2-2
■ Installation of the Printer Driver .....	2-3
● Before Installation .....	2-3
● Files to be Installed .....	2-3
● Installing to Windows 95/98/Me .....	2-4
● Installing to Windows NT 4.0 .....	2-7
● Installing to Windows 2000 .....	2-10
● Installing to Windows XP .....	2-14
● Uninstalling the Printer Driver .....	2-17
■ Test Print .....	2-18
■ Print from Applications .....	2-19
● Execution of Printing .....	2-19
● Print Settings .....	2-19
<b>Chapter 3 Printer Driver .....</b>	<b>3-1</b>
■ Contents of This Chapter .....	3-2
■ Working Environment .....	3-3
● Compliant OS .....	3-3
■ Property of Printer Driver .....	3-3

---

■ Printer Driver Function List .....	3-5
■ Description of Printer Driver Functions .....	3-8
● Alphabetic Order .....	3-8
<b>Chapter 4 Control Panel Setup .....</b>	<b>4-1</b>
■ Contents of This Chapter .....	4-2
■ About the Control Panel .....	4-3
● The Control Panel of the Printer/Copier .....	4-3
● How to Enter Settings on the LCD Touch Screen .....	4-4
● Printer Mode Basic Screen .....	4-5
● Printer Menu Screen .....	4-5
● Printer Setting Screen .....	4-6
● Procedures of the Printer Setting .....	4-7
■ Configuration of Printer Setting Menu .....	4-9
■ Functions of the Printer Setting .....	4-11
● Network Setup .....	4-11
● Select Language .....	4-11
● Print Quality .....	4-12
● I/O Timeout .....	4-12
● Test Print .....	4-13
● CMD Error Page .....	4-13
● Error Page .....	4-13
● Factory Default .....	4-14
● Help .....	4-14
<b>Chapter 5 Status Monitor and Control Panel .....</b>	<b>5-1</b>
■ Contents of This Chapter .....	5-2
■ Status Monitor and Control Panel .....	5-3
● About the Status Monitor .....	5-3
● About the Control Panel .....	5-3
■ Working Environment .....	5-4
● Compliant OS .....	5-4
● Interface .....	5-4
■ How to Install .....	5-4
■ How to Operate the Status Monitor .....	5-5
● Starting the Status Monitor .....	5-5
● Finishing the Status Monitor .....	5-5
● Restarting the Status Monitor .....	5-5
● Show/Hide the Status Monitor .....	5-6
● Display Change .....	5-7
■ How to Operate the Control Panel .....	5-8
● Starting the Control Panel .....	5-8
● Finishing the Control Panel .....	5-8
● Buttons of the Control Panel .....	5-9
● Settings of Paper .....	5-10
● Printer Setting .....	5-11
● Test Print .....	5-12
● Confirmation of Configurations .....	5-12

<b>Appendix A Troubleshooting .....</b>	<b>Appendix A-1</b>
■ Error Message .....	Appendix A-2
■ Basic Troubleshooting .....	Appendix A-3
■ General Problems of Printing .....	Appendix A-3
● The “OHT Film” is not selectable. ....	Appendix A-3
● The Print Controller does not respond to the “Print” command. ....	Appendix A-3
● A message to demand a paper size which you do not use is displayed. ....	Appendix A-4
● You can not print the test print. ....	Appendix A-4
● The print setting of a job does not correspond to the result of printing. ....	Appendix A-5
● The “Duplex” option is not displayed. ....	Appendix A-5
● Memory Error / Memory Overflow / Overrun .....	Appendix A-5
 <b>Appendix B Product Specifications .....</b>	 <b>Appendix B-1</b>
■ Product Specifications .....	Appendix B-2
 <b>Index .....</b>	 <b>Index-1</b>

## ■ Introduction

The IP-011 Print Controller is an option of the following copier.

Konica 7020 / 7022 / 7025 / 7030 / 7130 / 7035

In this manual, the above copier is described as 7020 series.

The IP-011 Print Controller works as an interface between the Konica 7020 series Printer/Copier and a workstation, and enables direct printing from the workstation environment.

The print engine on the printer side and the optional network interface card include separate operating manuals, namely, the 7020 series User's Manual and the KN-304 USER'S GUIDE (on CD), respectively.

For detailed operations of Windows 95/98/Me, Windows NT, Windows 2000 and Windows XP, refer to the operating manuals for each operating system. For applications operations, refer to the operating manuals provided with each application.

### FCC Regulations

**This equipment has been tested and found to comply with limits for a Class B digital device, pursuant to part 15 of FCC rules. These limits are designed to provide reasonable protection against harmful interference in a residential installation. This equipment generates, uses and can radiate radio frequency energy and, if not installed and used in accordance with the instructions, may cause harmful interference to radio communications. However, there is no guarantee that interference will not occur in a particular installation. If this equipment does cause harmful interference to radio or television reception, which can be determined by turning the equipment off and on, the user is encouraged to try to correct the interference by one or more of the following measures:**

- Reorient or relocate the receiving antenna.
- Increase the separation between the equipment and the receiver.
- Connect the equipment to an outlet on a circuit different from the circuit to which the receiver is connected.
- Consult the dealer or an experienced radio/TV technician for help.

### Canadian Department of Communications Regulations

**Cet appareil numérique de la classe B est conforme à la norme NMB-003 du Canada.**

**This Class B digital apparatus complies with Canadian ICES-003**

### About Registered Trademarks

Microsoft, MS and MS-DOS are registered trademarks of Microsoft Corporation in the United States.

IBM is a registered trademark of International Business Machines, Inc. in the United States.

Windows™ is a trademark of Microsoft Corporation.

Destiny® is a registered trademark of Destiny Technology Corporation.

LaserAct® is a registered trademark of Destiny Technology Corporation.

DPOS® is a registered trademark of Destiny Technology Corporation.

WinStyler®-Nozomi™ is a registered trademark of Destiny Technology Corporation.

WinPane® is a registered trademark of Destiny Technology Corporation.

Other company names and product names written in this manual are the registered trademarks or trademarks of their respective companies.

## Copyright

LaserAct® 6 Copyright©1992-1999, Destiny Technology Corp.Ver.2.0. All Rights Reserved.  
WinStyler®-Nozomi™ Copyright©1995-1999, Destiny Technology Corp.Ver.2.0. All Rights Reserved.  
WinPanel® Copyright©1995-1999, Destiny Technology Corp.Ver.1.0. All Rights Reserved.

- A part or all of this operating manual shall not be used or copied without permission.
- Konica shall have no liability for any influences caused by using the 7020 series Printer/Copier + IP-011 system and this manual.
- Information written in this operating manual is subject to change without notice.
- Konica Corp. shall have the copyright of this printer driver.
- This printer driver shall not be copied except for the purpose of backup.
- Konica shall have no liability for any influences caused by using this printer driver and the User's Guide.

## ■ About Supplied Items

The following items are supplied to the IP-011 Print Controller:

User Software CD

- Printer Driver
- User's Guide(this manual)
- Release Note (The latest information and limits of the system and the user software are written.)



## ■ About this Manual

This manual describes the printing operations of the Konica 7020 series Printer/Copier when it is connected to the Konica IP-011 Print Controller.

### — MEMO —

.....  
: An optional Network Interface Card (KN-304) is required to use the Konica 7020 series Printer/Copier as :  
: printer connected to a network. To learn more about printer operations on the network, refer to the “7020 :  
: series User’s Manual” and the “KN-304 USER’S GUIDE” which are provided with the Print Engine (7020 :  
: series) on the printer side and the optional Network Interface Card (KN-304), respectively. :  
:.....

This manual is composed of the following five chapters and Appendix:

### **Chapter 1 Overview**

Chapter 1 describes the Print Controller’s hardware and the overview of its functions, and briefly explains how to connect the parallel ports of computers to the Print Controller and the Printer (7020 series).

### **Chapter 2 Setup**

Chapter 2 describes how to install the user software which is supplied in the user software CD to the Windows-compliant computers. Installing the user software enables printing from each application of the Windows-compliant computers to the Printer (7020 series) by way of a network/parallel port.

### **Chapter 3 Printer Driver**

Chapter 3 describes the corresponding environment and various functions of the Printer Driver installed to the Windows-compliant computers.

### **Chapter 4 Control Panel Setup**

Chapter 4 describes the layout of the Control Panel of the Printer (7020 series) and explains how to operate and set functions on the Control Panel.

### **Chapter 5 Status Monitor and Control Panel**

Chapter 5 describes the layout of the Status Monitor and the Control Panel shown on the Windows-compliant computers and how to operate and set functions on the Status Monitor or the Control Panel.

### **Appendix**

Appendix describes error messages, troubleshooting tips for the Print Controller and product specifications.

## ■ System Requirements

### ● Windows

The following are required to print from the Windows-compliant computers to the Print Controller.

- Computers on which Windows 95/98/Me, Windows NT 4.0, Windows 2000 or Windows XP can run
- CD-ROM drive (necessary to install the user software)

#### **Using Windows 95/98/Me**

- Microsoft Windows 95/98/Me
- 32 MB RAM or more

#### **Using Windows NT 4.0**

- Microsoft Windows NT 4.0 (Service Pack 3 or later)
- 32 MB RAM or more

#### **Using Windows 2000**

- Microsoft Windows 2000
- 32 MB RAM or more

#### **Using Windows XP**

- Microsoft Windows XP
- 32 MB RAM or more

### ● Parallel Port

The following are required to print to the Print Controller by way of the parallel port.

- Windows-compliant computers
- Minimum RAM capacity suitable for computers (Refer to the section of each operation system described above.)
- IEEE 1284 parallel cable

One end of the cable is required to have an amphenol 36 pin male connector (connected to the Print Controller).

## ■ Conventions Used in this Manual

- Notation of the name of each section in this manual is written within quotation marks e.g., “Chapter 1 Outline.”
- Notation of names shown on the screen are written within square brackets e.g., click the [OK] button.
- Notation of cautions in this manual are shown with the caution symbol.

Each mark used in this manual has the following meaning.



Precautions and limits at the time of operating hardware or software are written.



Hints, advice, confirming items, etc. at the time of operating hardware or software are written.

- Notation of sub-folders

Sub-folders are written in a logical string as, for example, “\route level folder\sub folder 1\sub folder 2.”

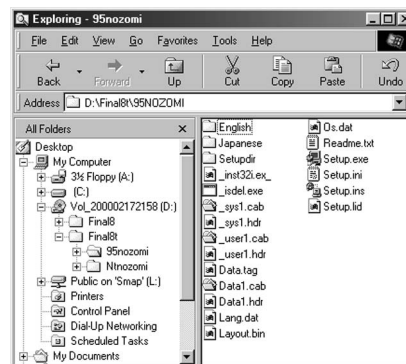

For example, instructions for double-clicking the [Setup.exe] icon in the [WIN\_95] folder in the [PS\_DRV] folder in the [INTALRS] folder of the User Software CD, are written as

Double-click the [Setup.exe] icon in the “\INTALRS\PS\_DRV\WIN\_95” folder of the User Software CD.

# Chapter 1 Overview

■ Contents of This Chapter .....	1-2
■ Overview of the Print Controller .....	1-3
● IP-011 and Print Engine .....	1-3
● IP-011 Hardware Configuration .....	1-4
● I/O Interface .....	1-4
● Data Flow .....	1-5
● How to Use Memory .....	1-6
● General View .....	1-7
■ About the Printer Tools .....	1-8
● About the Printer Tools .....	1-8
● About the Status Monitor .....	1-8
● About the Control Panel .....	1-8
■ About the Printer Driver .....	1-9
● Compliant OS .....	1-9

# Chapter 1 Overview

---

## ■ Contents of This Chapter

This chapter describes the outline of the Konica IP-011 Print Controller, which is attached to the Konica 7020 series engine. For copier functions, refer to the Konica 7020 series User's Manual.

## ■ Overview of the Print Controller

### ● IP-011 and Print Engine

The Konica IP-011 is the Print Controller (IP-011) used to connect the Konica 7020 series Printer/Copier to computers or to a network on which the Konica 7020 series can function as a printer from applications on Windows 95/98/Me, Windows NT, Windows 2000 or Windows XP. The optional Konica KN-304 Network Interface Card is required for connecting to a network.

When the command for printing is executed from applications on Windows 95/98/Me, Windows NT, Windows 2000 or Windows XP, print data is sent to the IP-011 by way of a parallel cable (IEEE 1284) or a network. Then, the IP-011 rasterizes the print data to image data, which is sent to the Konica 7020 series Print Engine by way of the PCI bus.

The IP-011 can receive the command for printing from applications even while the Print Engine is printing the previous print jobs or receiving data.

The 7020 series + IP-011 system supports the duplex function and the finisher function which enables the use of four paper trays, alternate printing and stapling.

### Conceptual Connection

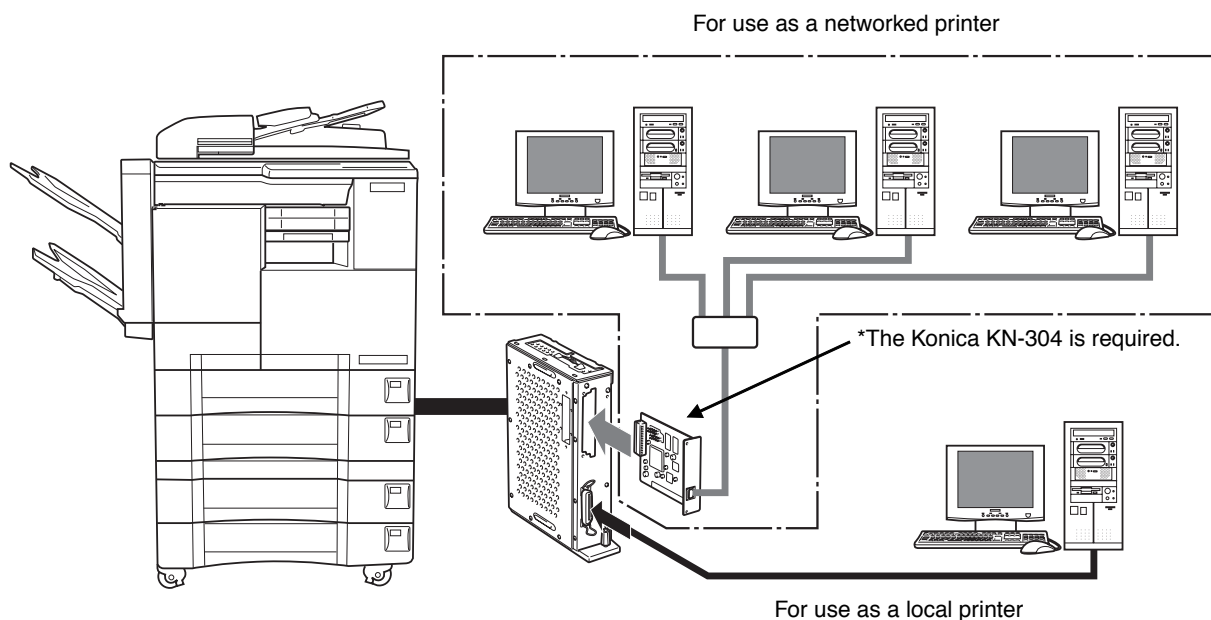

### E-RDH (Electronic Recirculating Document Handler)

The Konica 7020 series E-RDH is used to print from the IP-011. The E-RDH system temporarily stores in memory the print data you select from available options. The E-RDH memory is 32 MB (standard) and optional memory can be added.

In the IP-011, the E-RDH is used in the 1 bit mode. Data of approximately 180 pages of Letter/A4-size paper can be saved in the 32 MB (standard) E-RDH memory.

### Copy Mode and Printer Mode

The Control Panel of the Konica 7020 series can be used either in the copy mode or the printer mode.

Even while the Konica 7020 series is printing or copying, the IP-011 can receive the next job, and while the IP-011 is receiving a print job, you can execute copying.

# Chapter 1 Overview

---

## ● IP-011 Hardware Configuration

### Basic Configuration

Configuration of the IP-011 is as follows:

Control board

CPU: Power PC 401 GF

Program memory: FLASH ROM

System memory: 16 MB SD-RAM

### Memory

The IP-011 is equipped with 16 MB memory as standard and can be expanded to 80 MB.

## ● I/O Interface

### Parallel

Centronics (IEEE1284)/amphenol 36 pin male connector

### PCI Bus

Card Edge Type/20MHz/32bit

### Ethernet (option)

100BaseTX and 10BaseT

The optional KN-304 Network Interface Card is used to connect to the Ethernet. The KN-304 is the internal network interface card which supports multiple protocols on the Ethernet. This card includes a CPU and flash memory with an upgradable program.

The KN-304 supports the following network protocols.

- IPX/SPX (NetWare)
- LPD/LPR (TCP/IP)
- Peer-to-Peer (TCP/IP)

Refer to the corresponding operating manual for connection to the KN-304.

● Data Flow

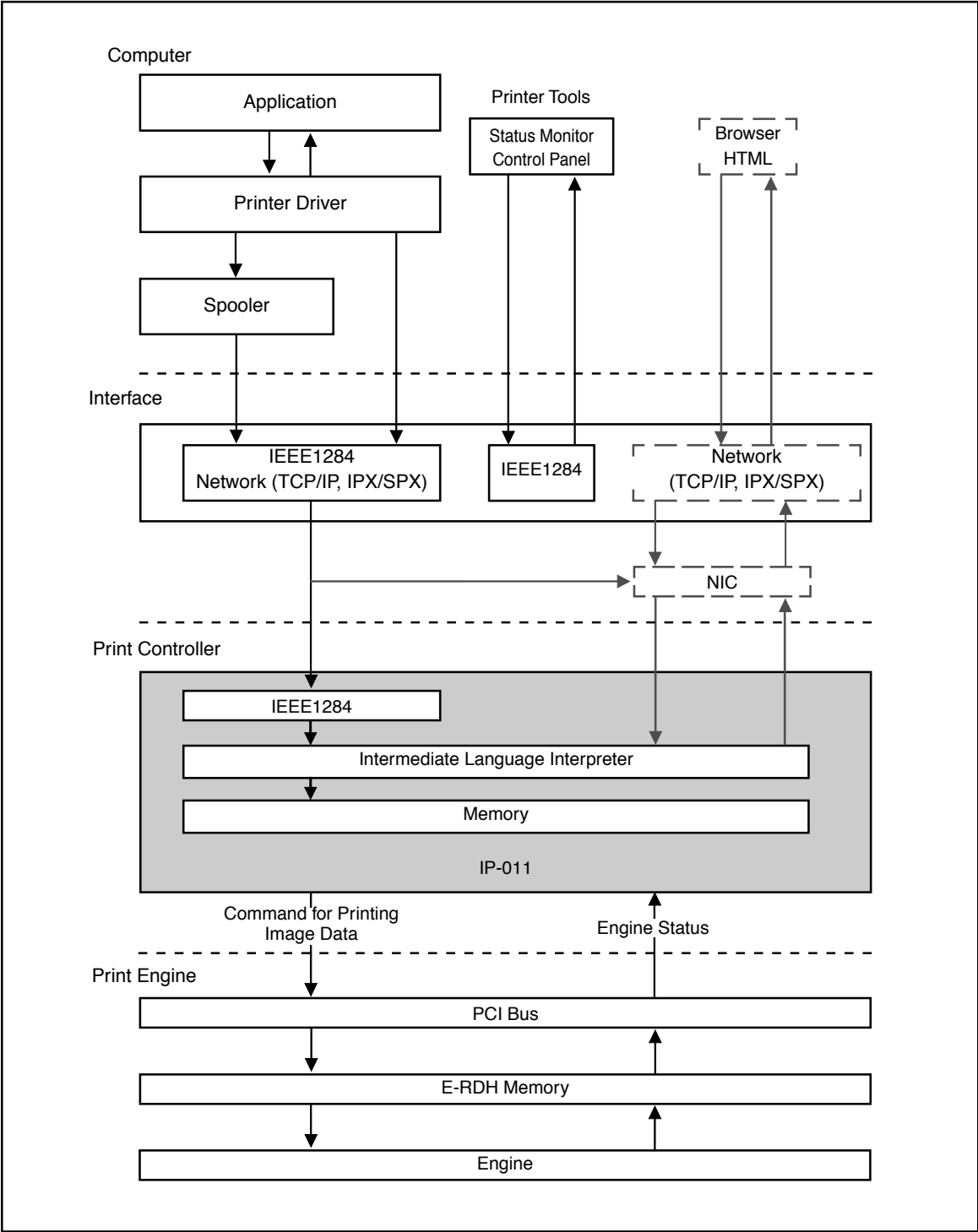



## ● How to Use Memory

Most of the IP-011 memory is used for rasterizing images only a small part of it is used for the system operation. The E-RDH memory of the Konica 7020 series is used for print processing.

The basic memory setting of the IP-011 is 16 MB, which allows 1 bit mode (600 dpi) printing for all sizes of paper. The memory of the IP-011 can be expanded to 80 MB maximum. For the E-RDH memory of the Konica 7020 series, optional memory can be added.

The more memory in the IP-011, the more pages can be rasterized while waiting for the previous job to print. When a A4-size paper is used, approximately 4,345 KB memory is used to print 1 bit data in 600 dpi.

### **Memory Upgrading**

To obtain optimum printer performance, memory expansion is recommended.

Contact the nearest Konica service provider for details.

● **General View**

The IP-011 is mounted to the Konica 7020 series. The following is the general view.

**IP-011**

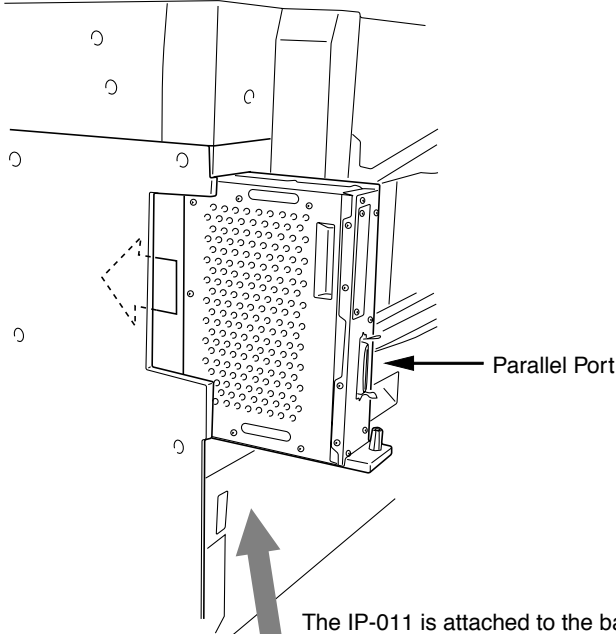

**Konica 7020 series**

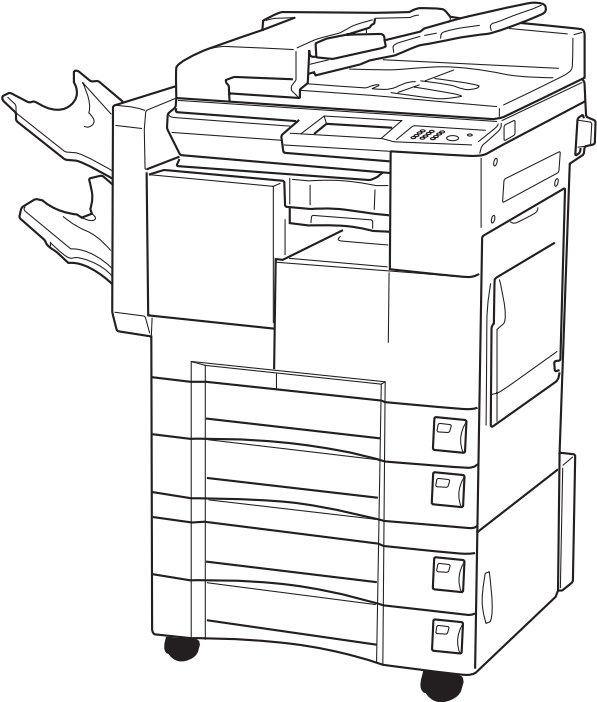

## ■ About the Printer Tools

### ● About the Printer Tools

Install the printer driver into the computer system connected to the Konica 7020 series + IP-011 system by using "Setup.exe" on the CD-ROM. During installation of the printer driver, you may simultaneously select installation of the Printer Tools, which is the generic name of two programs, "Status Monitor" and "Control Panel." The Printer Tools enable you to monitor the printer status from computers and to change printer settings. Refer to "Chapter 5 Status Monitor and Control Panel" (p. 5-1) for details of the Printer Tools.



### ● About the Status Monitor

During installation of the Printer Tools, you can set the Status Monitor to automatically start up when the 7020 series + IP-011 system starts up. The Status Monitor is a program that monitors printer status. Refer to "Chapter 2 Setup" (p. 2-1) for installation of the printer driver. Refer to "Chapter 5 Status Monitor and Control Panel" (p. 5-1) for details of the Status Monitor.



### ● About the Control Panel

The Control Panel enables you to view and change Printer Settings. To access the Control Panel from the Status Monitor Screen, click [Setup] then click [Printer Settings] from the menu. Refer to "Chapter 5 Status Monitor and Control Panel" (p. 5-1) for details of Control Panel.

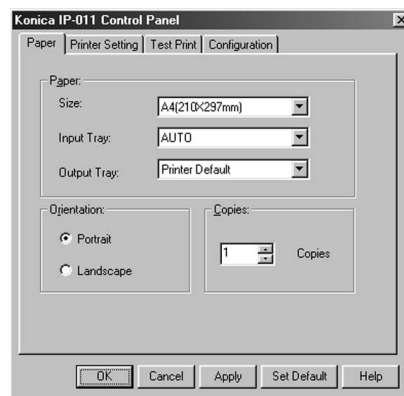

## ■ About the Printer Driver

### ● Compliant OS

The printer driver can be used on the following OS:

Windows 95

Windows 98

Windows Me

Windows NT 4.0 (Service Pack 3 or later)

Windows 2000

Windows XP

Refer to “Chapter 2 Setup” (p. 2-1) for how to install the printer driver.

Refer to “Chapter 3 Printer Driver” (p. 3-1) for detailed functions of the printer driver.

# Chapter 2 Setup

- Contents of This Chapter ..... 2-2
- Installation of the Printer Driver ..... 2-3
  - Before Installation ..... 2-3
  - Files to be Installed ..... 2-3
  - Installing to Windows 95/98/Me ..... 2-4
  - Installing to Windows NT 4.0 ..... 2-7
  - Installing to Windows 2000 ..... 2-10
  - Installing to Windows XP ..... 2-14
  - Uninstalling the Printer Driver ..... 2-17
- Test Print ..... 2-18
- Print from Applications ..... 2-19
  - Execution of Printing ..... 2-19
  - Print Settings ..... 2-19

### ■ Contents of This Chapter

To use the 7020 series + IP-011 system, connect the 7020 series + IP-011 system to computers by way of the parallel port and install the printer driver on the computers. This chapter describes how to install the printer driver and shows how to print from applications.

Refer to “Chapter 3 Printer Driver” (p. 3-1) for functions of the printer driver.

## ■ Installation of the Printer Driver

### ● Before Installation

#### Models and Environment of Computers

The Konica 7020 series Print Controller with the IP-011 can be used with most computers ranging from personal computers to workstations.

The IP-011 includes the printer driver for Windows 95/98/Me, Windows NT, Windows 2000 and Windows XP. The printer driver can be installed to computer model as long as Windows 95/98/Me, Windows NT, Windows 2000 or Windows XP have been installed on them.

#### About Windows 95/98/Me, Windows NT, Windows 2000 and Windows XP

Since the ways to manage the user interface and the printer are different on Windows 95/98/Me, Windows NT, Windows 2000 or Windows XP, the method of installing the printer driver and the ways to print with the printer will vary. Therefore, the Konica IP-011 includes the specific printer driver for each Windows environment.

Please keep the “User Software CD” on hand since it is required to install the printer driver.

Ways to install the printer driver in each Windows environment are explained in “Installing to Windows 95/98/Me”, “Installing to Windows NT 4.0”, “Installing to Windows 2000” and “Installing to Windows XP”. Please read the section that is appropriate for your Windows environment.

### ● Files to be Installed

When the printer driver is installed with the “User Software CD”, the following files are installed to your computer.

The files to be installed vary, depending on the ways to install. Select an appropriate way.

OS Name	Installing to Windows 95/98/Me			Installing to Windows NT		Installing to Windows 2000		Installing to Windows XP	
	Setup.exe (User Software CD)	Add Printer	Plug & Play	Setup.exe (User Software CD)	Add Printer	Setup.exe (User Software CD)	Add Printer	Setup.exe (User Software CD)	Add a printer
Printer Driver for 95/98/Me	○	○	○	X	X	X	X	X	X
Printer Driver for NT	X	X	X	○	○	X	X	X	X
Printer Driver for 2000	X	X	X	X	X	○	○	X	X
Printer Driver for XP	X	X	X	X	X	X	X	○	○
Konica IP-011 Printer Tools	○	X	X	○	X	○	X	○	X
Konica IP-011 Help	○	X	X	○	X	○	X	○	X
Uninstaller	○	X	X	○	X	○	X	○	X

## Chapter 2 Setup

---

### ● Installing to Windows 95/98/Me

To install the Konica IP-011 Printer Driver to Windows 95/98/Me perform the following steps. Please keep the “User Software CD” on hand since it is required to install the printer driver.

#### Installation with the “User Software CD”

1. Turn on the computer and start Windows.  
Exit from all active Windows applications, if required.
2. Set the “User Software CD” on the CD-ROM drive.
3. Double-click the [My Computer] icon of the desktop to open the [My Computer] window. Then, double-click the active CD icon (User Software CD).

#### — MEMO —

##### Opening from the [Start] menu

Right-click the [Start] button of the task bar to click [Explorer]. Then, you can select the active CD icon (User Software CD) from [Address].

4. Double-click the [95nozomi] folder to double-click [Setup.exe] in the folder.



5. The [Konica IP-011 Setup] screen will appear. Then, click the [Next] button.
6. The [Konica IP-011 Software License Agreement] screen will appear. Then, click the [Yes] button.

To use the Konica IP-011 Printer Driver, you are required to agree to the license.

When you agree to the license, click the [Yes] button to proceed.



7. The [Type of Connection] screen will appear. Then, select [Local] and click the [Next] button.

When the Konica 7020 series Printer/Copier (IP-011) is directly connected to a computer to which the printer driver will be installed, select [Local].

— MEMO —

**When selecting [Network]**

When personal computers or workstations are connected to the network and you want to print via the network, connect to the optional Network Interface Card (KN-304) and select [Network].

8. The screen to select a port will appear. Then, select the port to which the Konica 7020 series Printer/Copier is connected and click the [Next] button.
9. The [Printer Name] screen will appear. Then, specify the printer name and click the [Next] button.  
Default: [Konica IP-011]
10. The [Select Destination Path] screen will appear. Enter the location where you would like to install the component and click the [Next] button.  
Default: [C:\Program Files\Konica IP-011]
11. The [Select Components] screen will appear. Select the components you would like to install and click the [Next] button.  
Choice is made initially to install only the printer driver. To install Printer Tools together, put the check mark of Printer Tools additionally.  
When you print via the network, Printer Tools can not be operated. Remove the check mark of the Printer Tools.
12. If you have selected to install Printer Tools, The [Status Monitor Option] screen will appear. Click either [Yes] or [No] button.  
When the [Yes] button is clicked, the Status Monitor of the printer will automatically start when starting PC. When the [No] button is clicked, it will not automatically start.
13. The [Confirm Setup] screen will appear. Confirm the installed components and click the [Next] button.
14. The [Setup Complete] screen will appear. Select the way to complete the setup and click the [Finish] button.

The printer driver of the Konica IP-011 becomes available without restarting your computer.

The Konica IP-011 Printer Tools become available after restarting your computer.

## Chapter 2 Setup

---

### Installation by using [Add Printer]

In this method, only the printer driver is installed.

1. Turn on the computer and start Windows.  
Exit from all active Windows applications, if required.
2. Click the [Start] button of the task bar. Then, select [Settings] of the [Start] menu to click [Printers] from the sub-menu.

The [Printers] window will open.

#### — MEMO —

##### Opening from [My Computer]

To open the [Printers] window, double-click the [Printers] folder after double-clicking the [My Computer] icon on the desktop.

3. Double-click the [Add Printer] icon of the [Printers] window.  
The [Add Printer Wizard] will appear. Then, follow the [Add Printer Wizard] to install the printer driver.

### Installation by Using the Plug & Play

In this method, only the printer driver is installed.

1. Connect the IP-011 to a computer with the computer turned off.
2. Turn on the computer and start Windows  
Devices compliant with the Plug & Play are automatically detected, and [Add New Hardware Wizard] will appear.
3. Click the [Next] button.  
The wizard to select the method of searching for the printer driver will appear.
4. Select [Search for the best driver for your device] and click the [Next] button.  
The wizard to select the location to search for the printer driver will appear.
5. Set the “User Software CD” on the CD-ROM drive. Then, select [Specify a location] and click the [Browse] button.
6. Click “\Installer\95nozom\English” folder of the “User Software CD” and click the [OK] button.
7. Click the [Next] button.
8. Click the [Next] button.
9. Specify your printer's name and click the [Next] button.  
Default: [Konica IP-011]
10. The print test confirmation screen will appear. Select whether you will perform the print test or not and click the [Finish] button.  
Select [Yes (recommended)] to perform the print test, while select [No] not to perform it.
11. Click the [Finish] button.  
Necessary files will be copied from the “User Software CD” to finish the installation.

## ● Installing to Windows NT 4.0

Only authorized system administrators or printer administrators should install the Konica IP-011 Printer Driver to Windows NT 4.0.

Please keep the "User Software CD" on hand since it is required to install the printer driver.

### Printer Management on Windows NT

Since Windows NT is an operating system made specially for the network operation, it is equipped with heavier security functions than Windows 95/98/Me.

According to the security level (access rights) of the user, the range of operations and settings of the installed printer driver allowed to the user is limited.

The following figure shows the access rights of the Windows NT compliant printers and its operation range.

Access Rights	Operation Range
No Rights	No operations of printers are allowed.
Printing	Execution of document printing and the following print conditions of each document are allowed to be set. <ul style="list-style-type: none"> <li>• Operations related to printing (selection of a paper size and paper tray, etc.)</li> <li>• Operations related to graphics (processing of resolution and halftone, etc.)</li> <li>• Printer functions (selection of functions peculiar to the copier)</li> </ul>
Document Management	<ul style="list-style-type: none"> <li>• Control of document setting</li> <li>• Pause, restart, reprinting, and deletion of documents</li> </ul>
Full Control	<ul style="list-style-type: none"> <li>• All of "Printing" and "Document Management"</li> <li>• Pause and restart of the printer and deletion of all documents</li> <li>• Settings and changes of printer information</li> <li>• Deletion of the printer</li> <li>• Settings and changes of printer access rights</li> </ul>

After installing the printer driver, set the appropriate access rights to printer users.

Refer to the "System Guide" of Windows NT for how to set access rights of the printer.

## Chapter 2 Setup

### Installation by Using the “User Software CD”

1. Turn on the computer to start Windows NT 4.0.  
Exit from all active Windows applications, if required.
2. Log on as an administrator (or a user entitled to install the Power User, etc.).
3. Set the “User Software CD” on the CD-ROM drive.
4. Double-click the [My Computer] icon of the desktop to open the [My Computer] window, and double-click the active CD icon (User Software CD).

#### — MEMO —

##### Opening from the [Start] menu.

Right-click the [Start] button of the task bar to click [Explorer]. Then, you can select the CD icon (User Software CD) from [All Folders].

5. Double-click the “\installer\NTnozomi” folder to double-click [Setup.exe] in the folder.



6. The [Konica IP-011 Setup] screen will appear. Then, click the [Next] button.
7. The [Konica IP-011 Software License Agreement] screen will appear. Then, click the [Yes] button.  
To use the Konica IP-011 Printer Driver, you are required to agree to the license.  
When you agree to the license, click the [Yes] button to proceed.
8. The [Type of Connection] screen will appear. Then, select [Local] and click the [Next] button.  
When the Konica 7020 series Printer/Copier (IP-011) is directly connected to a computer to which the printer driver is to be installed, select [Local].

#### — MEMO —

##### When selecting [Network]

When installing Konica IP-011 printer driver to Windows NT 4.0 that does not conduct print service, select [Network]. When the optional Network Interface Card (KN-304) is used, refer to the KN-304 USER'S GUIDE to select the appropriate port.

9. The [Select the Local Port] screen will appear. Then, select the port to which the Konica 7020 series Printer/Copier is connected and click the [Next] button.

10. The [Printer Name] screen will appear. Then, specify the printer name and click the [Next] button.  
Default: [Konica IP-011]
11. The [Select Destination Path] screen will appear. Select the location where you would like to install the component and click the [Next] button.  
Default: [C:\Program Files\Konica IP-011]
12. The [Select Components] screen will appear. Select the components you would like to install and click the [Next] button.  
  
Choice is made initially to install only the printer driver. To install Printer Tools together, put the check mark of Printer Tools additionally.  
  
When you print via the network, Printer Tools can not be operated. Remove the check mark of the Printer Tools.
13. If you have selected to install Printer Tools, The [Status Monitor Option] screen will appear. Click either [Yes] or [No] button.  
  
When the [Yes] button is clicked, the Status Monitor of the printer will automatically start when starting PC. When the [No] button is clicked, it will not automatically start.
14. The [Confirm Setup] screen will appear. Confirm the installed components and click the [Next] button.
15. The [Setup complete] screen will appear. Select the way to complete the setup and click the [Finish] button.

### Installation by Using [Add Printer]

In this method, only the printer driver is installed.

1. Turn on the computer and start Windows NT 4.0.  
Exit from all active Windows applications, if required.
2. Log on as an administrator (or a user entitled to install the Power User, etc.).
3. Click the [Start] button of the task bar. Then, select [Settings] of the [Start] menu and click [Printers] from the sub-menu.  
The [Printers] window will open.

#### — MEMO —

##### Opening from [My Computer]

You can open the [Printers] window by double-clicking the [Printers] folder after double-clicking the [My Computer] icon of the desktop.

4. Double-click the [Add Printer] icon of the [Printers] window.  
The [Add Printer Wizard] to install the printer driver will appear.  
Then, follow [Add Printer Wizard] to install the printer driver.

## Chapter 2 Setup

---

### ● Installing to Windows 2000

Only authorized system administrators or printer administrators should install the Konica IP-011 Printer Driver to Windows 2000.

Please keep the "User Software CD" on hand since it is required to install the printer driver.

#### Printer Management on Windows 2000

Since Windows 2000 is an operating system made specially for the network operation, it is equipped with heavier security functions than Windows 95/98/Me.

According to the security level (access rights) of the user, the range of operations and settings of the installed printer driver allowed to the user is limited.

The following figure shows the access rights of the Windows 2000 compliant printers and its operation range.

Access Rights	Operation Range
No Rights	No operations of printers are allowed.
Printing	Execution of document printing and the following print conditions of each document are allowed to be set. <ul style="list-style-type: none"><li>• Operations related to printing (selection of a paper size and paper tray, etc.)</li><li>• Operations related to graphics (processing of resolution and halftone, etc.)</li><li>• Printer functions (selection of functions peculiar to the copier)</li></ul>
Printer Management	<ul style="list-style-type: none"><li>• All of "Printing" management</li><li>• Pause and restart of the printer</li><li>• Changes of settings of printer spooling</li><li>• Share of the printer</li><li>• Settings of printer access rights</li><li>• Changes of printer property</li></ul>
Document Management	<ul style="list-style-type: none"><li>• Control of document setting</li><li>• Pause, restart, reprinting, and deletion of documents</li></ul>

After installing the printer driver, set the appropriate access rights to printer users.

Refer to the "Online Help" of Windows 2000 for how to set access rights of the printer.

## Installation by Using the “User Software CD”

1. Turn on the computer to start Windows 2000.  
Exit from all active Windows applications, if required.
2. Log on as an administrator (or a user entitled to install the Power User, etc.).
3. Set the “User Software CD” on the CD-ROM drive.
4. Double-click the [My Computer] icon on the desktop to open the [My Computer] window, and double-click the active CD icon (User Software CD).

### — MEMO —

#### Opening from the [Start] menu.

Right-click the [Start] button of the task bar to click [Explorer]. Then, you can select the CD icon (User Software CD) from [Folders].

5. Double-click the “\installer\2knozomi” folder to double-click [Setup.exe] in the folder.
6. The [Konica IP-011 Setup] screen will appear. Then, click the [Next] button.
7. The [Konica IP-011 Software License Agreement] screen will appear. Then, click the [Yes] button.  
  
To use the Konica IP-011 Printer Driver, you are required to agree to the license.  
  
When you agree to the license, click the [Yes] button to proceed.
8. The [Type of Connection] screen will appear. Then, select [Local] and click the [Next] button.  
  
When the Konica 7020 series Printer/Copier (IP-011) is directly connected to a computer to which the printer driver is to be installed, select [Local].
9. The screen to select a port will appear. Then, select the port to which the Konica 7020 series Printer/Copier is connected and click the [Next] button.
10. The [Printer Name] screen will appear. Then, specify the printer name and click the [Next] button.  
  
Default: [Konica IP-011]
11. The [Select Destination Path] screen will appear. Select the location where you would like to install the component and click the [Next] button.  
  
Default: [C:\Program Files\Konica IP-011]
12. The [Select Components] screen will appear. Select the components you would like to install and click the [Next] button.  
  
Choice is made initially to install only the printer driver. To install Printer Tools together, put the check mark of Printer Tools additionally.  
  
When you print via the network, Printer Tools can not be operated. Remove the check mark of the Printer Tools.
13. If you have selected to install Printer Tools, The [Status Monitor Option] screen will appear. Click either [Yes] or [No] button.  
  
When the [Yes] button is clicked, the Status Monitor of the printer will automatically start when starting PC. When the [No] button is clicked, it will not automatically start.

14. The [Confirm Setup] screen will appear. Confirm the installed components and click the [Next] button.

15. [Digital Signature Not Found] window will appear. Then, Click the [Yes] button.

When you click the [Yes] button, the printer driver is installed. If you click the [No] button, the installation will not be done.

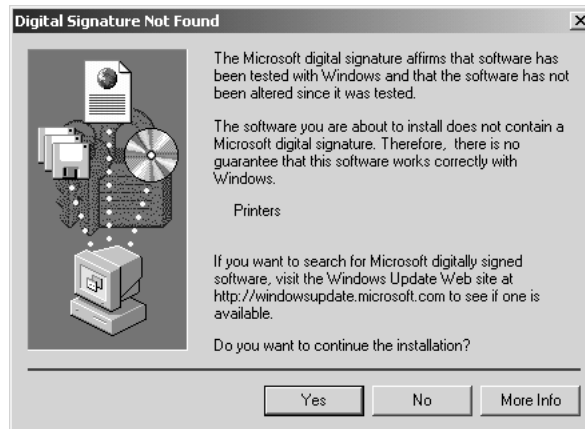

16. The [Setup Complete] screen will appear. Select the way to complete the setup and click the [Finish] button.

### Installation by Using [Add Printer]

In this method, only the printer driver is installed.

1. Turn on the computer and start Windows 2000.  
Exit from all active Windows applications, if required.
2. Log on as an administrator (or a user entitled to install the Power User, etc.).
3. Click the [Start] button of the task bar. Then, select [Settings] of the [Start] menu and click [Printers] from the sub-menu.

The [Printers] window will open.

#### — MEMO —

##### Opening from [My Computer]

You can open the [Printers] window by double-clicking the [Printers] folder after double-clicking the [Control Panel] folder in [My Computer] icon of the desktop.

4. Double-click the [Add Printer] icon of the [Printers] window.

The [Add Printer Wizard] to install the printer driver will appear.

Then, follow [Add Printer Wizard] to install the printer driver.



5. Click the [Finish] button on the window showing [Completing the Add Printer Wizard].

[Digital Signature Not Found] window will appear. Then, Click the [Yes] button.

When you click the [Yes] button, the printer driver is installed to open the [Printers] window. If you click the [No] button, the installation will not be done.

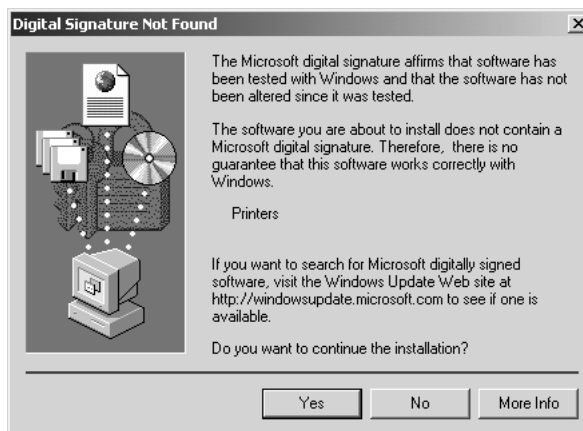

## Chapter 2 Setup

---

### ● Installing to Windows XP

Only authorized system administrators or printer administrators should install the Konica IP-011 Printer Driver to Windows XP.

Please keep the "User Software CD" on hand since it is required to install the printer driver.

#### Printer Management on Windows XP

Since Windows XP is an operating system made specially for the network operation, it is equipped with heavier security functions than Windows 95/98/Me.

According to the security level (access rights) of the user, the range of operations and settings of the installed printer driver allowed to the user is limited.

The following figure shows the access rights of the Windows XP compliant printers and its operation range.

Access Rights	Operation Range
No Rights	No operations of printers are allowed.
Printing	Execution of document printing and the following print conditions of each document are allowed to be set. <ul style="list-style-type: none"><li>• Operations related to printing (selection of a paper size and paper tray, etc.)</li><li>• Operations related to graphics (processing of resolution and halftone, etc.)</li><li>• Printer functions (selection of functions peculiar to the copier)</li></ul>
Printer Management	<ul style="list-style-type: none"><li>• All of "Printing" management</li><li>• Pause and restart of the printer</li><li>• Changes of settings of printer spooling</li><li>• Share of the printer</li><li>• Settings of printer access rights</li><li>• Changes of printer property</li></ul>
Document Management	<ul style="list-style-type: none"><li>• Control of document setting</li><li>• Pause, restart, reprinting, and deletion of documents</li></ul>

After installing the printer driver, set the appropriate access rights to printer users.

Refer to the "Online Help" of Windows XP for how to set access rights of the printer.

## Installation by Using the “User Software CD”

1. Turn on the computer to start Windows XP.  
Exit from all active Windows applications, if required.
2. Log on as an administrator (or a user entitled to install the Power User, etc.).
3. Set the “User Software CD” on the CD-ROM drive.
4. Click the [Start] button of the task bar. Then, click the [My Computer] of the [Start] menu to open the [My Computer] window, and double-click the active CD icon (User Software CD).

### — MEMO —

#### Opening from the [Start] menu.

Right-click the [Start] button of the task bar to click [Explorer]. Then, you can select the CD icon (User Software CD) from [Folders].

5. Double-click the “\installer\xpnozomi” folder to double-click [Setup.exe] in the folder.
6. The [Konica IP-011 Setup] screen will appear. Then, click the [Next] button.
7. The [Konica IP-011 Software License Agreement] screen will appear. Then, click the [Yes] button.  
  
To use the Konica IP-011 Printer Driver, you are required to agree to the license.  
  
When you agree to the license, click the [Yes] button to proceed.
8. The [Type of Connection] screen will appear. Then, select [Local] and click the [Next] button.  
  
When the Konica 7020 series Printer/Copier (IP-011) is directly connected to a computer to which the printer driver is to be installed, select [Local].
9. The [Select the Local Port] screen will appear. Then, select the port to which the Konica 7020 series Printer/Copier is connected and click the [Next] button.
10. The [Printer Name] screen will appear. Then, specify the printer name and click the [Next] button.  
  
Default: [Konica IP-011]
11. The [Select Destination Path] screen will appear. Select the location where you would like to install the component and click the [Next] button.  
  
Default: [C:\Program Files\Konica IP-011]
12. The [Select Components] screen will appear. Select the components you would like to install and click the [Next] button.  
  
Choice is made initially to install only the printer driver. To install Printer Tools together, put the check mark of Printer Tools additionally.  
  
When you print via the network, Printer Tools can not be operated. Remove the check mark of the Printer Tools.
13. If you have selected to install Printer Tools, The [Status Monitor Option] screen will appear. Click either [Yes] or [No] button.  
  
When the [Yes] button is clicked, the Status Monitor of the printer will automatically start when starting PC. When the [No] button is clicked, it will not automatically start.

14. The [Confirm Setup] screen will appear. Confirm the installed components and click the [Next] button.

15. When [Software Installation] window appears, click the [Continue Anyway] button.

When you click the [Continue Anyway] button, the printer driver is installed. If you click the [STOP Installation] button, the installation will not be done.



16. The [Setup Complete] screen will appear. Select the way to complete the setup and click the [Finish] button.

### Installation by Using [Add a printer]

In this method, only the printer driver is installed.

1. Turn on the computer and start Windows XP.  
Exit from all active Windows applications, if required.
2. Log on as an administrator (or a user entitled to install the Power User, etc.).
3. Click the [Start] button of the task bar. Then, click [Printers and Faxes] of the [Start] menu.

The [Printers and Faxes] window will open.

4. Double-click the [Add a printer] icon of the [Printers and Faxes] window.

The [Add Printer Wizard] to install the printer driver will appear.

Then, follow [Add Printer Wizard] to install the printer driver.

5. Click the [Finish] button on the window showing [Completing the Add Printer Wizard].

[Hardware Installation] window will appear. Then, Click the [Continue Anyway] button.

When you click the [Continue Anyway] button, the printer driver is installed to open the [Printers and Faxes] window. If you click the [STOP Installation] button, the installation will not be done.



## ● Uninstalling the Printer Driver

1. Exit from all active Windows applications.
2. Click the [Start] button of the task bar to select [Programs] of the [Start] menu and then, selecting [Konica IP-011] to click [Uninstaller].

— MEMO —

For Windows XP, click the [Start] button of the task bar to select [All Programs] of the [Start] menu and then, selecting [Konica IP-011] to click [Uninstaller].

3. Click the [OK] button.  
The screen to confirm uninstallation will appear.
4. When the [OK] button is displayed, click the [OK] button.  
The printer driver will be uninstalled.

— MEMO —

When uninstalling the printer driver from Windows 2000/XP, a part of printer driver information remains. To learn on complete uninstallation of the printer driver, refer to the operation manual for Windows 2000/XP.

### ■ Test Print

You can check whether the printer driver functions properly by performing a test print after the printer driver has been installed.

1. Click the [Start] button of the task bar. Then, select [Settings] of the [Start] menu and click [Printers] in the sub menu.

The [Printers] window will open.

— MEMO —

**Using Windows XP**

Click the [Start] button of the task bar. Then, select [Printers and Faxes] to open the [Printers and Faxes] window.

— MEMO —

**Opening from [My Computer]**

**Using Windows 95/98/Me/NT4.0**

To open the [Printers] window, double-click the [Printers] folder after double-clicking the [My Computer] icon on the desktop.

**Using Windows 2000**

To open the [Printers] window, double-click the [Printers] folder after double-clicking the [Control Panel] folder in [My Computer] icon on the desktop.

2. Right-click [Konica IP-011] and click [Properties].  
[Konica IP-011 Properties] will appear.
3. Select [General] of [Konica IP-011 Properties] and click the [Print Test Page] button.  
A test print will start and a screen to confirm print end will appear.
4. Click the [Yes] button (from Windows 95/98/Me/NT) or the [OK] button (from Windows 2000/XP).  
A test print will end.

## ■ Print from Applications

### ● Execution of Printing

1. Click the [File] menu of each application and click [Print].
2. Check that [Konica IP-011] is shown on [Printer Name] and click [OK].

When [Konica IP-011] is not shown, select it from the list box.

#### — MEMO —

Setting the [Print] dialog box

Refer to the user's manual of each application.

Print settings of the printer driver

Refer to "Print Settings" (p.2-19) for print settings of the printer driver.

### ● Print Settings

Perform various settings at the time of printing on the printer driver setup screen.

1. Click the [File] menu of each application and click [Print].
2. Check that [Konica IP-011] is shown on [Printer Name] and click [Properties].

When [Konica IP-011] is not shown, select it from the list box.

[Konica IP-011 Properties] will appear.

# Chapter 2 Setup

## Contents of Settings

Details of each setting are described as follows:

Items and their setting ranges shown on the screen and their descriptions are explained in detail. The underlined setting ranges indicate the default settings.

### [Setup] tab

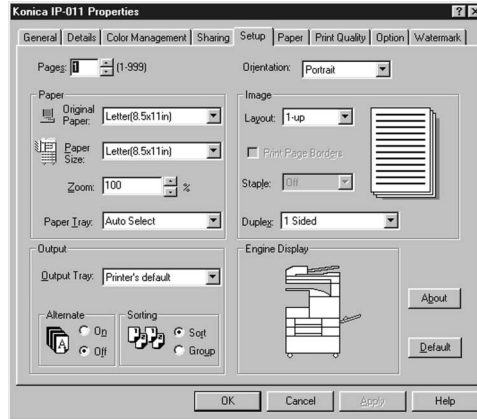

[Copies] (Pages): 1 to 999

Specifies the number of copies of the print job.

[Orientation]: Portrait or Landscape

Specifies the print orientation.

[Paper]-[Original Paper]:

Specifies the original size set on the application.

A3(297 x 420 mm), A4R(210 x 297 mm), A4(210 x 297 mm),  
A5R(148 x 210 mm), B4(257 x 364 mm), B5(182 x 257 mm), B5R(182 x 257 mm), Ledger(11 x 17 in),  
Legal(8.5 x 14 in), Letter(8.5 x 11 in), Letter R(8.5 x 11 in), Statement(5.5 x 8.5 in), F4(8.5 x 13 in)

[Paper]-[Paper Size]:

Specifies the paper size used for printing.

A3(297 x 420 mm), A4R(210 x 297 mm), A4(210 x 297 mm),  
A5R(148 x 210 mm), B4(257 x 364 mm), B5(182 x 257 mm), B5R(182 x 257 mm), Ledger(11 x 17 in),  
Legal(8.5 x 14 in), Letter(8.5 x 11 in), Letter R(8.5 x 11 in), Statement(5.5 x 8.5 in), F4(8.5 x 13 in)

[Paper]-[Zoom]: 25 % to 400 % (default value: 100 %)

Specifies the enlargement or reduction rate at the time of printing.

[Paper]-[Paper Tray]: Auto Select, Tray 1, Tray 2, Tray 3, Tray 4 or Bypass

Specifies the paper tray which holds the paper to be used for printing.

When [Auto Select] is specified, papers are automatically fed from the tray that has a appropriate paper size specified by a user.

When [Bypass] is specified, you can feed paper from the bypass tray.

### — MEMO —

In order to specify [Tray 3] or [Tray 4], the DB (optional Paper Tray) must be attached to the copier.



[Image]-[Layout]: 1-up, 2-up, 4-up, 8-up or 9-up

Specifies how many pages of documents are gathered on one piece of paper. The default value, [1-up], indicates that an one-page document is printed on one piece of paper.

[Image]-[Print Page Borders]: Default value (not printing: without a check mark)

Specifies whether borders are printed or not between documents when they are gathered on one piece of paper.

[Image]-[Staple]: Off, 1-left, 1-right, 2-left, or 2-top

Specifies the number of staples to be used and their positions.

When [Off] is selected, documents are not stapled.

### — MEMO —

The staple function is available when [2 Trays], [3 Trays] or [4 Trays] are not selected in the Finisher setting, or when they are not installed.

[Image]-[Duplex]: 1 Sided, 2 Sided (long edge binding), 2 Sided (short edge binding) or Booklet

[1 Sided] prints only one side.

[2 Sided (long edge binding)] prints both sides so that the document appears correctly when the document is bound at the long edge while [2 Sided (short edge binding)] prints both sides so that the document appears correctly when the document is bound at the short edge.

[Booklet] prints in consideration of making booklets.

[Output]-[Output Tray]: Printer's default, Tray 1, Tray 2, Tray 3 or Tray 4

Specifies the way to output.

When [Printer's default] is selected, the output tray specified on [Paper] of the Control Panel will be used for output.

### — MEMO —

To specify [Tray 2], [Tray 3] and [Tray 4], a finisher or Inner Tray must be attached to the Printer/Copier and the [Finisher] option must be selected.

[Output]-[Alternate]: On or Off

Effective only when [2 Trays], [3 Trays] or [4 Trays] are not installed in the finisher. The output direction of paper is changed every set of copy.

[Output]-[Sorting]: Sort or Group

Specifies how to output the multiple pages and multiple copy jobs.

[Engine Display]:

Shows the external view of the copier system.

[About] button:

Shows information on the version of the printer driver.

[Default] button:

Returns to the default value.

## Chapter 2 Setup

---

### [Paper] tab

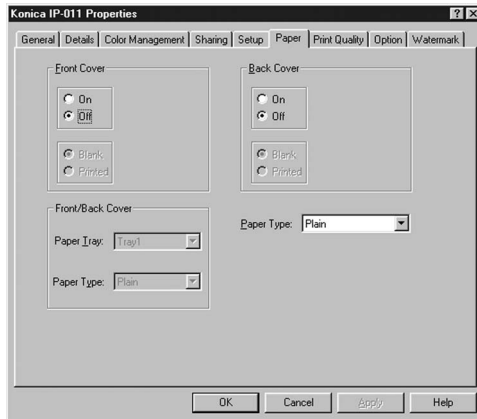

[Front Cover]: On, Off, Blank or Printed

Specifies whether a front cover is attached or not. Also specifies whether the front cover is blank or printed when it is attached.

[Back Cover]: On, Off, Blank or Printed

Specifies whether a back cover is attached or not. Also specifies whether the back cover is blank or printed when it is attached.

[Front/Back Cover]-[Paper Tray]: Tray 1, Tray 2, Tray 3, Tray 4 or Bypass

Specifies the output tray where paper for a front cover or a back cover is set.

[Front/Back Cover]-[Paper Type]: Plain

Specifies the paper type of a front cover or a back cover.

[Paper Type]: Plain, OHT Film, OHT Interleaved or OHT Printed-Interleaved

Specifies the paper type of other paper than a front cover or a back cover.

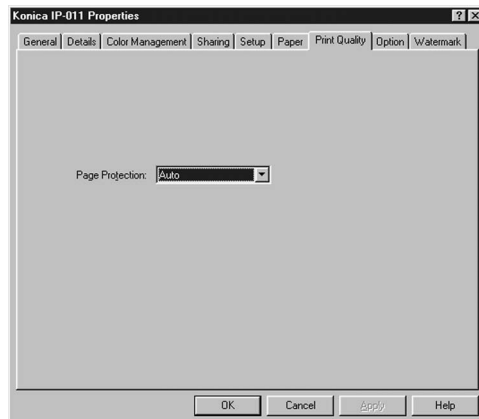
**[Print Quality] tab**

[Page Protection]: Auto or On

Specifies how to protect page data.

The page protection is a function to secure memories required to print complicated characters or image documents in advance, and completely create one-page print data before actual printing starts.

This function secures printing of each page and avoids the memory overrun error.

Normally, set this setting to [Auto]. If any errors occur, try to set it to [On]. Setting it to [On] decreases the printing speed and requires more memories, but may reduce printing errors.

## Chapter 2 Setup

---

### [Option] tab

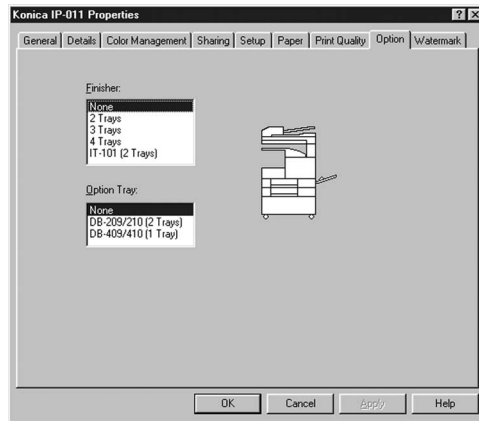

[Finisher]: None, 2 Trays, 3 Trays, 4 Trays or IT-101(2 Trays)

Specifies the Finisher of the copier option.

[Option Tray]: None, DB-209/210(2 Trays) or DB-409/410(1 Tray)

Specifies the Option Tray of the copier option.

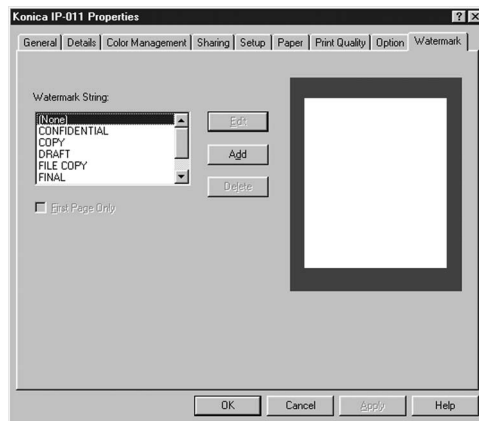
**[Watermark] tab**

[Watermark String]: (None), CONFIDENTIAL, COPY, DRAFT, FILE COPY, FINAL, PROOF or  
TOP SECRET

Specifies the watermark.

[First Page Only]:

Prints the watermark on the first page only.

[Edit] button:

Edits the watermark.

(Refer to “[Edit/Add Watermark] dialog box” on 2-26 page.)

[Add] button:

Adds new watermarks.

(Refer to “[Edit/Add Watermark] dialog box” on 2-26 page.)

— MEMO —

• You can add up to 50 watermarks. •

[Delete] button:

Deletes watermarks.

## Chapter 2 Setup

---

### [Edit/Add Watermark] dialog box

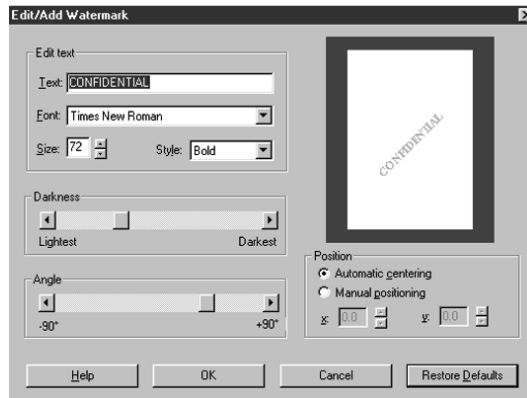

[Edit text]:

Specifies [Text], [Font], [Size] and [Style].

[Darkness]:

Specifies the darkness of the edit text.

[Angle]: -90 degrees to +90 degrees

Specifies the angle of the edit text.

[Position]: Automatic centering or Manual positioning

Specifies where on a page the edit text is put.

# Chapter 3 Printer Driver

- Contents of This Chapter ..... 3-2
- Working Environment ..... 3-3
  - Compliant OS ..... 3-3
- Property of Printer Driver ..... 3-3
- Printer Driver Function List ..... 3-5
- Description of Printer Driver Functions ..... 3-8
  - Alphanumeric Order ..... 3-8

### ■ Contents of This Chapter

This chapter fully describes the functions of the Printer Driver installed in computers connected to the Konica 7020 series + IP-011 system. The Printer Driver functions are presented in two parts, first listed, then described individually.

Refer to "Chapter 2 Setup" (p. 2-1) for installation of the Printer Driver.



## ■ Working Environment

### ● Compliant OS

The Printer Driver can be used on the following OS:

Windows 95	Windows 98
Windows Me	Windows NT4.0 (Service Pack 3 or later)
Windows 2000	Windows XP

Refer to “Chapter 2 Setup” (p. 2-1) for installation of the Printer Driver.

## ■ Property of Printer Driver

### If the driver in use is for Windows 95/98/Me:

On the [Printers] window shown by clicking [Start]-[Settings]-[Printers], right-click the [Konica IP-011] icon. When [Properties] is clicked on the shown menu, [Konica IP-011 Properties] will appear. You can set all functions of the Printer Driver on [Konica IP-011 Properties].

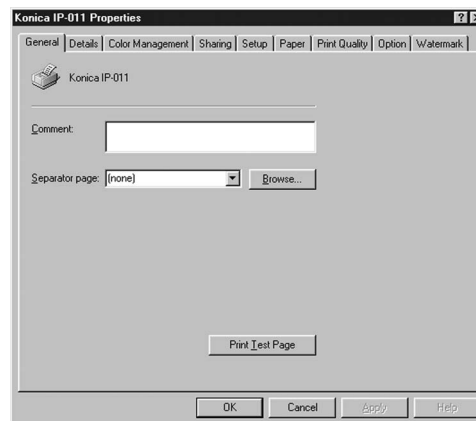

### [OK]

When the [OK] button is clicked, all tab settings are saved with the close of the properties screen.

### [Cancel]

When the [Cancel] button is clicked, all tab settings are canceled with the close of the properties screen.

### [Apply]

When the [Apply] button is clicked, the present tab settings are saved. This button is used when settings continue to be performed by using other tabs, and the present tab settings are registered before using other tabs.

### [Help]

When the [Help] button is clicked, Help of each tab will appear.

### [General] tab

Enables a print test of a printer.

## Chapter 3 Printer Driver

### [Details] tab

Performs settings related to ports, drivers, timeout and spooling.

### [Sharing] tab

Performs share settings of a printer.

### [Setup] tab

Performs settings related to Pages, Original Size, Paper Size, Zoom, Paper Tray, Output Tray, Alternate, Sorting, Orientation, Layout, Staple and Duplex.

### [Paper] tab

Performs settings related to Front Cover, Back Cover and Paper Type.

### [Print Quality] tab

Performs settings related to Page Protection.

### [Option] tab

Performs settings related to Finisher and Option Tray (DB).

### [Watermark] tab

Performs settings related to Watermark.

You can perform any printer settings but [General] tab / [Details] tab / [Color Management] tab / [Sharing] tab of [Konica IP-011 Properties] from applications. Refer to “Chapter 2 Setup” (p. 2-1) for how to perform printer settings from applications.

#### If the driver in use is for Windows NT4.0:

In the [Printers] window, which opens when clicking [Start]-[Settings]-[Printers], right-click the [Konica IP-011] icon, and then click [Document Defaults] on the resulting menu. [Konica IP-011 Default] will appear.

The content of [Konica IP-011 Default] is the same as is offered for use in printer setting from applications (Konica IP-011 Properties) when the driver in use is for Windows 95/98/Me.

#### If the driver in use is for Windows 2000/XP:

[Setup] tab, [Paper] tab, [Print Quality] tab, [Option] tab and [Watermark] tab are not displayed on the [Konica IP-011 Properties]. To set up the printer driver for Windows 2000/XP using these [Setup] tab, [Paper] tab, [Print Quality] tab, [Option] tab and [Watermark] tab, click [Printing Preferences] button on [General] tab to show [Konica IP-011 Printing Preferences] dialog, or click [Printing Defaults] button on [Advanced] tab to show [Konica IP-011 Printing Defaults] dialog.

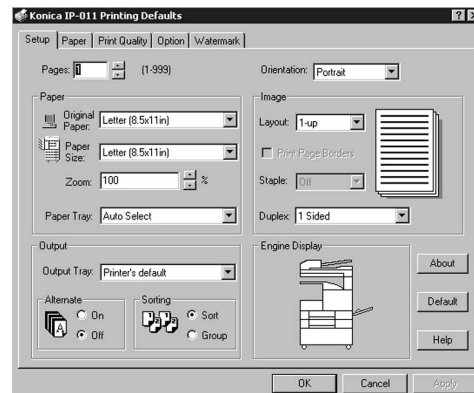
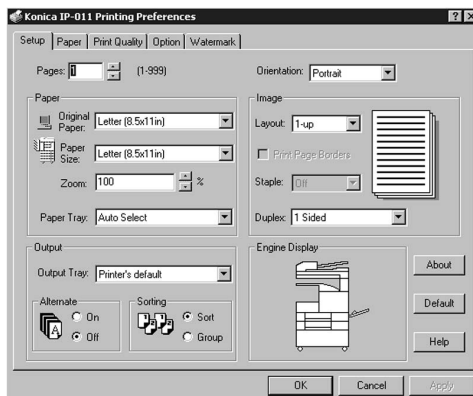

Additionally, refer to “Chapter 4 Control Panel Setup” (p. 4-1) for how to perform printer settings from the 7020 series Control Panel and “Chapter 5 Status Monitor and Control Panel” (p. 5-1) for how to perform printer settings from the Printer Tools.

## ■ Printer Driver Function List

The following list summarizes functions (Setting items) which can be set by using the Printer Driver of the Konica 7020 series + IP-011 system.

Refer to “■ Description of Printer Driver Functions” (p. 3-8) for setting items of each function.

In addition, refer to “Chapter 2 Setup” (p. 2-1) for how to perform printer settings from applications, “Chapter 4 Control Panel Setup” (p. 4-1) for how to perform printer settings from the LCD Touch Screen and “Chapter 5 Status Monitor and Control Panel” (p. 5-1) for how to perform printer settings from the Printer Tools.

Classification	Setting Items	Set Value	Description	95/98 /Me	NT 4.0	2000	XP
Port - related Matters	Timeout settings	Not selected Transmission retry	This function is used to set timeout of the parallel port and resending time.	○	○	○	○
	Port Settings	Spool MS-DOS print jobs, Check port state before printing	This function is used to set whether the MS-DOS print job is spooled or not and whether the status of the LPTx: port is checked before printing or not.	○	-	-	-
	Print to the following port	COM1 COM2 FILE LPT1	This function is used to set the printing port.	○	○	○	○
	Capture Printer Port	Device Path Reconnect at log-on	This function is used to set the device name and path of the printer at the time of printing by way of a network and whether reconnection is performed or not at the time of log-on.	○	-	-	-
	End Capture	-	This function is used to unallocate the network paths of unnecessary network printers.	○	-	-	-
	Add Port	Network Other	This function is used to add a port.	○	○	○	○
	Delete Port	-	This function is used to delete an unnecessary port.	○	○	○	○
Driver-related Matters	New Driver	-	This function is used to add a driver.	○	○	○	○
Spooling-related Matters	Spool Settings	Spool print jobs so program finishes printing faster. Print directly to the printer. Enable bi-directional support for this printer. Disable bi-directional support for this printer.	This function is used to set spooling and bi-directional communication functions.	○	○	○	○

## Chapter 3 Printer Driver

Classification	Setting Items	Set Value	Description	95/98 /Me	NT 4.0	2000	XP
Konica 7020 series special functions	Layout	1-up 2-up 4-up 8-up 9-up	This function is used to print two pages, four pages, eight pages or nine pages of documents on one piece of paper.	<input type="radio"/>	<input type="radio"/>	<input type="radio"/>	<input type="radio"/>
	Print Page Borders	On Off	This function is used to specify whether borders are printed or not between documents when they are gathered on one piece of paper.	<input type="radio"/>	<input type="radio"/>	<input type="radio"/>	<input type="radio"/>
	Staple	Off 1-left 1-right 2-left 2-top	This function is used to select the staple position.	<input type="radio"/>	<input type="radio"/>	<input type="radio"/>	<input type="radio"/>
	Duplex	1 Sided 2 Sided (long edge binding) 2 Sided (short edge binding) Booklet	This function is used to set the way of the Duplex printing.	<input type="radio"/>	<input type="radio"/>	<input type="radio"/>	<input type="radio"/>
	Alternate (available only when the finisher is not attached)	On Off	This function is used to set the Alternate printing to on or off.	<input type="radio"/>	<input type="radio"/>	<input type="radio"/>	<input type="radio"/>
	Sorting	Sort Group	This function is used to specify how to output the multiple pages	<input type="radio"/>	<input type="radio"/>	<input type="radio"/>	<input type="radio"/>
	Print Quality	Page Protection Auto On	This function is used to specify about Page Protection.	<input type="radio"/>	<input type="radio"/>	<input type="radio"/>	<input type="radio"/>
	Front Cover	On Off Printed or Blank	This function is used when front covers are used.	<input type="radio"/>	<input type="radio"/>	<input type="radio"/>	<input type="radio"/>
	Back Cover	On Off Printed or Blank	This function is used when back covers are used.	<input type="radio"/>	<input type="radio"/>	<input type="radio"/>	<input type="radio"/>
	Front/Back Cover Paper Tray	Tray 1 Tray 2 Tray 3 Tray 4 Bypass	This function is used to select an output tray used for front covers and back covers.	<input type="radio"/>	<input type="radio"/>	<input type="radio"/>	<input type="radio"/>
Front/Back Cover Paper Type	Plain	This function is used to specify the paper type used for printing front covers or back covers.	<input type="radio"/>	<input type="radio"/>	<input type="radio"/>	<input type="radio"/>	
Option	Finisher	None 2 Trays 3 Trays 4 Trays IT-101(2 Trays)	This function is used to select the Finisher which is an optional device of the copier.	<input type="radio"/>	<input type="radio"/>	<input type="radio"/>	<input type="radio"/>
	Option Tray	None DB-209/210 (2 Trays) DB-409/410 (1 Tray)	This function is used to select the DB which is an optional device of th copier.	<input type="radio"/>	<input type="radio"/>	<input type="radio"/>	<input type="radio"/>

Specification	Setting Items	Set Value	Description	95/98 /Me	NT 4.0	2000	XP
Paper-related Matters	Copies (Pages)	1 to 999	This function is used to specify the number of copies to be printed.	<input type="radio"/>	<input type="radio"/>	<input type="radio"/>	<input type="radio"/>
	Original Paper	A3, A4, A4R, A5R, B4, B5, B5R, F4, Ledger, Legal, Letter, LetterR, Statement	The original paper you can set differs depending on specifications in the country and trays.	<input type="radio"/>	<input type="radio"/>	<input type="radio"/>	<input type="radio"/>
	Paper Size	The same as Original Paper	The paper sizes you can set differ depending on specifications in the country and trays. Refer to operating manual of the copier for details.	<input type="radio"/>	<input type="radio"/>	<input type="radio"/>	<input type="radio"/>
	Zoom	25% to 400%	This function is used to specify the enlargement or reduction rate of image in percentage.	<input type="radio"/>	<input type="radio"/>	<input type="radio"/>	<input type="radio"/>
	Paper Tray	Auto Select Tray 1 to 4 Bypass	This function is used to specify the paper tray.	<input type="radio"/>	<input type="radio"/>	<input type="radio"/>	<input type="radio"/>
	Output Tray	Printer's default, Tray 1 to 4	This function is used to specify the output tray.	<input type="radio"/>	<input type="radio"/>	<input type="radio"/>	<input type="radio"/>
	Orientation	Portrait Landscape	This function is used to specify the orientation.	<input type="radio"/>	<input type="radio"/>	<input type="radio"/>	<input type="radio"/>
	Paper Type	Plain OHT Film OHT Interleaved OHT Printed- Interleaved	This function is used to specify the paper type to be printed.	<input type="radio"/>	<input type="radio"/>	<input type="radio"/>	<input type="radio"/>
Watermark	Watermark	(None) CONFIDENTIAL COPY DRAFT FILE COPY FINAL PROOF TOP SECRET	This function is used to specify a watermark.	<input type="radio"/>	<input type="radio"/>	<input type="radio"/>	<input type="radio"/>
	First Page Only	-	This function is used to print a watermark on the first page only.	<input type="radio"/>	<input type="radio"/>	<input type="radio"/>	<input type="radio"/>
	Edit	-	This function is used to edit a watermark.	<input type="radio"/>	<input type="radio"/>	<input type="radio"/>	<input type="radio"/>
	Add	-	This function is used to add a watermark.	<input type="radio"/>	<input type="radio"/>	<input type="radio"/>	<input type="radio"/>
	Delete	-	This function is used to delete a watermark.	<input type="radio"/>	<input type="radio"/>	<input type="radio"/>	<input type="radio"/>
Others	About	-	This function is used to show version information of the Printer Driver.	<input type="radio"/>	<input type="radio"/>	<input type="radio"/>	<input type="radio"/>
	Default	-	This function is used to return the settings to default settings.	<input type="radio"/>	<input type="radio"/>	<input type="radio"/>	<input type="radio"/>
	Print Test Page	-	This function is used to perform a test print.	<input type="radio"/>	<input type="radio"/>	<input type="radio"/>	<input type="radio"/>

## ■ Description of Printer Driver Functions

Functions (setting items) which can be set with the Printer Driver are summarized in the alphabetic order. These settings can be set by using [Start]-[Settings]-[Printers]-[Konica IP-011] properties (Windows 95/98/Me), or [Document Defaults] (Windows NT4.0) and [Printing Preferences] / [Printing Defaults] (Windows 2000/XP). The tabs in this section are those in the [Konica IP-011] properties.

### ● Alphabetic Order

#### A

#### About

When [Setup] tab-[About] button is clicked, version information of the Printer Driver is shown.

#### Add Port

When the port you would like to connect to is not shown on the list shown by clicking the [▼] button beside the [Details] tab-[Print to the following port], click [Details] tab-[Add Port] button to add the port.

When the [Add Port] button is clicked, the [Add Port] dialog is shown.

The following settings are performed on the [Add Port] dialog:

- When [Network] is selected to set a path to a network printer, you can add a network printer to a port
- When [Other] is selected to select the type of a port to be added, you can add the port selected from a list

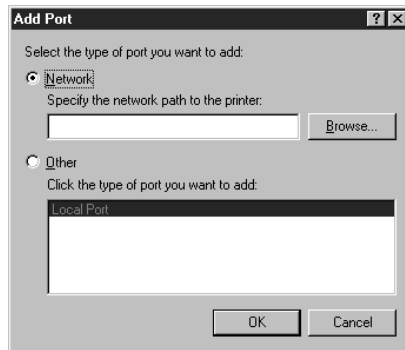
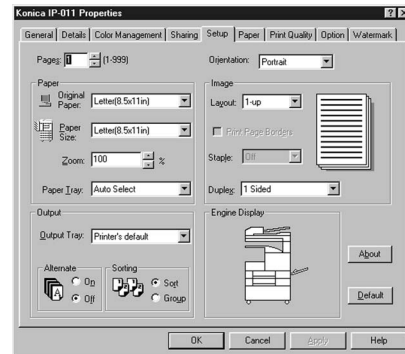

#### Alternate

When the following conditions are satisfied, you can perform settings of the alternate printing by using [Setup] tab-[Alternate]:

- When [2 Trays], [3 Trays] or [4 Trays] are not selected in the Finisher setting, or when they are not installed
- When [A4], [Letter] or [B5] is selected in the Paper settings
- When the same size of paper for both portrait and landscape is set to the copier (e.g., A4/A4R, or B5/B5R)
- When Front/Back Cover are not set
- When [Booklet] is not selected in the [Duplex]

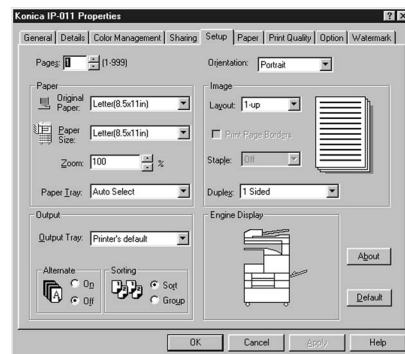

When [On] is selected in the Alternate printing, every set of copies are output in a direction at right angles to the previous set of copies.

e.g.

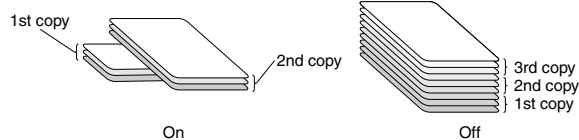

## B

**Back Cover**

By using [Paper] tab-[Back Cover], you can perform the setting to use a designated tray for printing the last page.

Select either [On] or [Off].

Default of Back Cover is [Off].

When [On] is selected, select either [Blank] or [Printed].

When [Blank] is selected, nothing is printed on the back cover.

When [Printed] is selected, the last page is printed on a back cover.

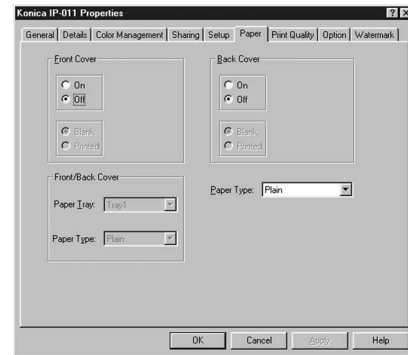

The tray for the back cover is selected by using [Front/Back Cover]-[Paper Tray].

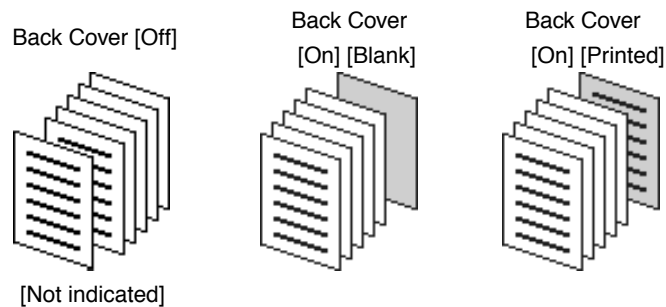

Back Cover can not be set in the following conditions:

- When [B6R] is selected as a paper size
- When Alternate is set to [On]
- When Duplex is set to [Booklet]
- When Sort is set to [Group]

## C

**Capture Printer Port**

When the device name and path are specified on the [Capture Printer Port] dialog shown by clicking [Details] tab-[Capture Printer Port] button, a network printer can be allocated as a virtual printer port.

In addition, when [Reconnect at log-on] of the [Capture Printer Port] dialog is selected, a virtual printer port is automatically reconnected at log-on.

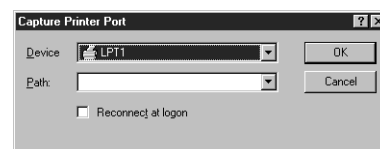
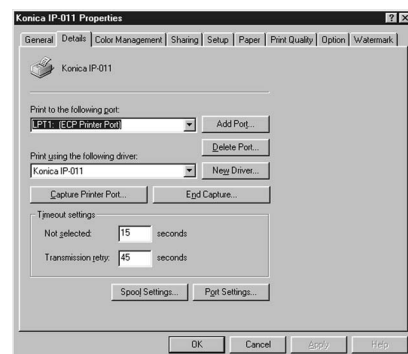

# Chapter 3 Printer Driver

## Copies (Pages)

Click the [▲] or [▼] button beside [Setup] tab-[Copies] (Pages) or directly enter the number of copies from the keyboard.

Default of the number of copies is [1].



## Default

By clicking [Setup] tab-[Default] button, settings of the [Setup] tab, [Paper] tab, [Print Quality] tab, and [Watermark] tab return to defaults.

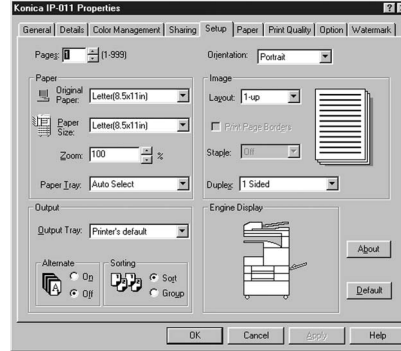

## Delete Port

When a port is specified on the [Delete Port] dialog shown by clicking [Details] tab-[Delete Port] button, and the [OK] button is clicked, you can delete the specified port.

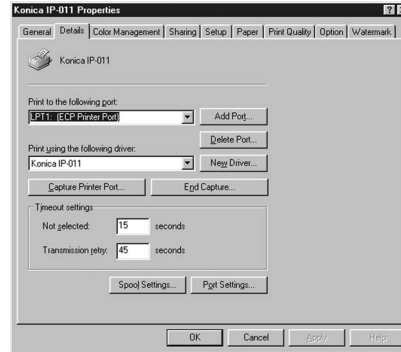
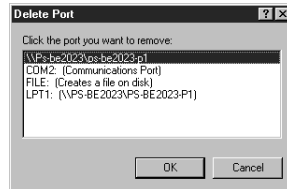



## Duplex

By using [Setup] tab-[Duplex], you can perform settings of the Duplex printings.

You can select [1 Sided], [2 Sided (short edge binding)], [2 Sided (long edge binding)] or [Booklet] from the list shown by clicking the [▼] button beside the [Duplex] box.

Default of the Duplex printing is [1 Sided].

When [1 Sided] is selected, only one side of paper is printed.

[2 Sided (short edge binding)], [2 Sided (long edge binding)] or [Booklet] can not be selected in the following conditions:

- When [B6R] is selected as a paper size

[Booklet] can not be selected in the following conditions as well:

- When settings other than [Letter], [Letter R], [Ledger], [A3], [A4], [A4R], [B4], [B5R] or [B5] are selected as a paper size
- When Staple is set to settings other than [Off]
- When Front/Back Cover is set
- When Alternate is set to [On]

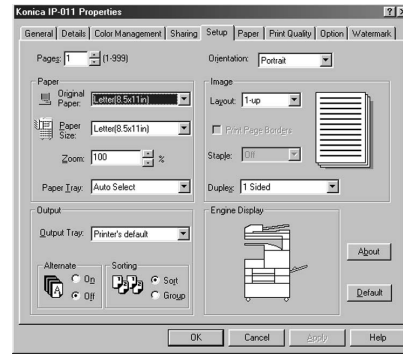

[2 Sided (short edge binding)]

Prints paper so that the document appears correctly when the document is bound at the short edge.

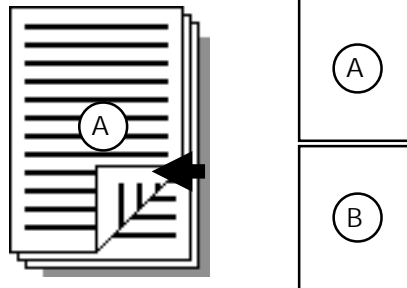

[2 Sided (long edge binding)]

Prints paper so that the document appears correctly when the document is bound at the long edge.

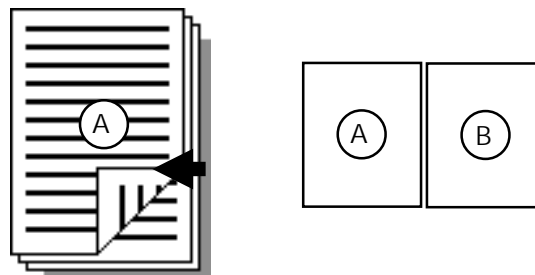

[Booklet]

Prints paper so that booklets are made when it is folded into two.

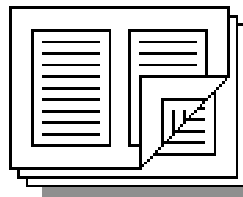

### E

#### End Capture

When the virtual printer port is specified on the [End Capture] dialog shown by clicking [Details] tab-[End Capture] button, you can delete a network printer allocated as a virtual printer port.

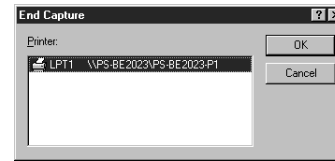

### F

#### Finisher

When the Finisher is attached to the copier, you can select the Finisher setting from [None], [2 Trays], [3 Trays], [4 Trays] or IT-101(2 Trays).

Default of the Finisher is [None].

When [None] is selected in the Finisher settings, or when the Finisher is not installed, the function has limits as follows:

- You can not select settings other than [Printer's default] as an output tray
- Staple settings can not be performed

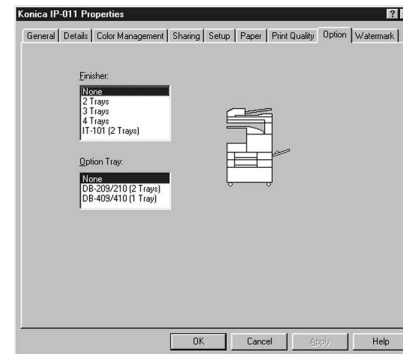

The Alternate printing is available when [2 Trays], [3 Trays] or [4 Trays] are not selected in the Finisher setting, or when they are not installed.

In this case, it is required that the same size of paper for both portrait and landscape is set to the copier. (e.g., A4/A4R, or B5/B5R)

#### Front Cover

By using [Paper] tab-[Front Cover], the setting to print the first page from the designated tray can be performed.

Select either [On] or [Off].

Default of Front Cover is [Off].

When [On] is selected, select either [Blank] or [Printed].

When [Blank] is selected, nothing is printed on the first page.

When [Printed] is selected, the first page is printed on the front cover.

The tray for front covers is selected by using [Front/Back Cover]-[Paper Tray].

Front Cover can not be set in the following conditions:

- When [B6R] is selected as a paper size
- When Alternate is set to [On]
- When Duplex is set to [Booklet]
- When Sorting is set to [Group]

When Front Cover is set to [On], you can not use the Alternate printing and Sorting.

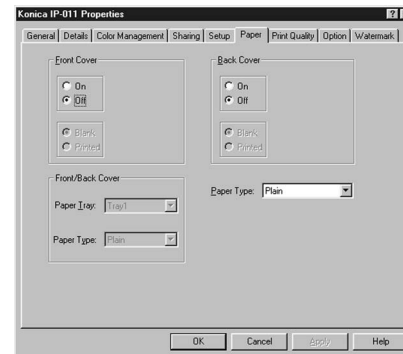

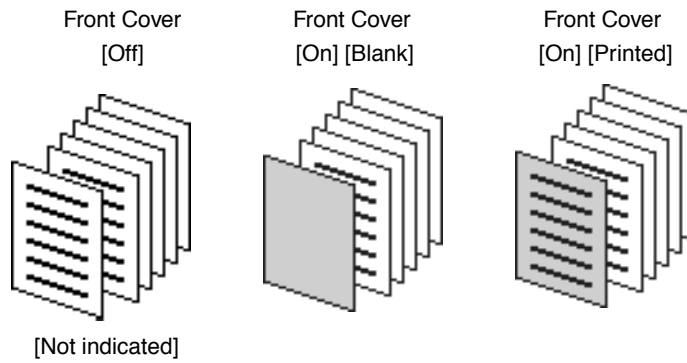

### Front/Back Cover-Paper Tray

Specify the tray for Front/Back Cover from the list shown by clicking the [▼] button beside the [Paper] tab-[Front/Back Cover]-[Paper Tray] button.

The selection by using [Front/Back Cover]-[Paper Tray] must be different from that by using the [Setup] tab-[Paper Tray].

### Front/Back Cover-Paper Type

Specify the tray for Front/Back Cover from the list shown by clicking the [▼] button beside the [Paper] tab-[Front/Back Cover]-[Paper Type] button.



### Group

Refer to Sorting.



### Layout

By using [Setup] tab-[Layout], you can set how many pages of documents are printed on one piece of paper.

You can select 1-up, 2-up, 4-up, 8-up or 9-up from the list shown by clicking the [▼] button beside the [Layout] box.

Default of Layout is [1-up].

The layout is made as follows:

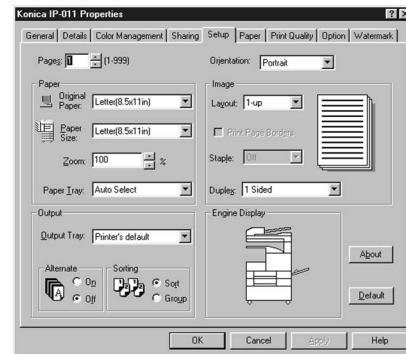

[1-up]



[2-up]



[4-up]

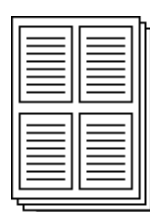

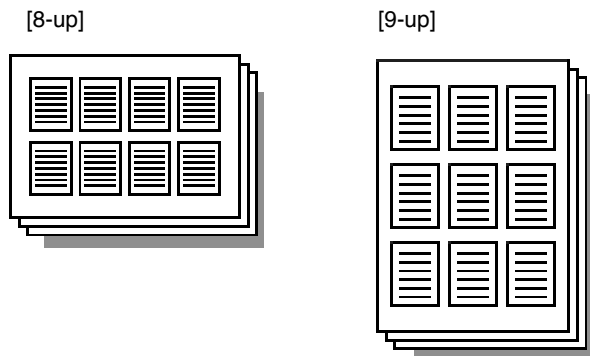

When [Booklet] is selected in the Duplex printing, [2-up] is automatically selected and you can not select other settings.

When [Setup] tab-[Print Page Borders] check box is selected, you can print borders between gathered documents.

Default of Print Page Borders is no check mark.

When Layout is set to [1-up], you can not select [Print Page Borders].

### N

#### New Driver

Click the [Details] tab, then click the [▼] button next to the field [Print using the following driver] to display the list of available printer drivers. To use a printer driver not listed, click the [New Driver] button. When a driver is changed, the settings of presently shown property is saved and the property of a newly selected driver is shown.

### O

#### Option

Refer to Finisher and Option Tray (DB).

#### Option Tray (DB)

When the Option Tray is attached to the Konica 7020 series, it is required to set the [Option Tray] in the [Option] tab. Select either [DB-209/210 (2 Trays)] or [DB-409/410 (1 Tray)].

Default of the Option Tray is [None].

By setting the Option Tray, functions are limited or enabled as follows:

- When [None] is selected in the Option Tray settings or when the Option Tray is not installed, you can not select [Tray 3] or [Tray 4].
- When [DB-409/410 (1 Tray)] is selected in the Option Tray settings, you can not select [Tray 4] as a paper tray.
- When [DB-209/210 (2 Trays)] is selected in the Option Tray settings, you can select all trays as a paper tray.

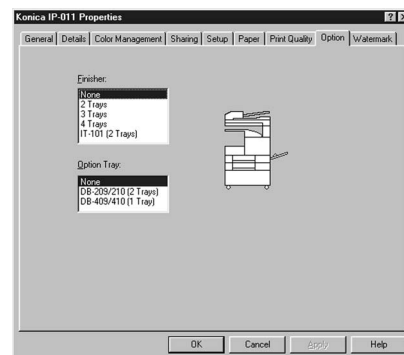

## Orientation

Select either [Portrait] or [Landscape] from the list shown by clicking the [▼] button beside [Set up] tab-[Orientation] box.

Default of Orientation is [Portrait].

## Output Tray

Select an output tray from the list shown by clicking the [▼] button beside [Setup] tab-[Output Tray] box. When [None] is selected in the Finisher settings, or When the Finisher is not installed, settings other than [Printer's default] can not be selected.

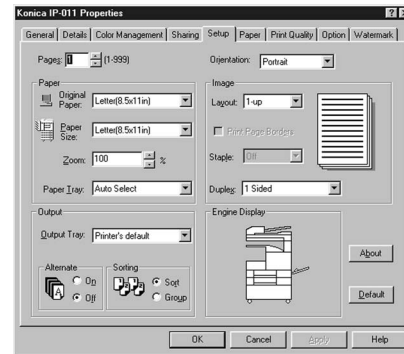

## P

## Page Protection

By using [Print Quality] tab-[Page Protection] box, you can set Page Protection. Page Protection is a function to secure memory for printing complicated characters and image documents in advance. Page Protection completely develops one page of print data before actual printing starts. This secures printing of each page and avoid the memory overrun error.

Select either [Auto] or [On] from the list shown by clicking the [▼] button beside the [Page Protection] box.

Default of Page Protection is [Auto].

Normally, set this setting to [Auto]. If an error occurs, set it to [On]. When it is set to [On], the print speed decreases and more memory is used, but a print error may be reduced.

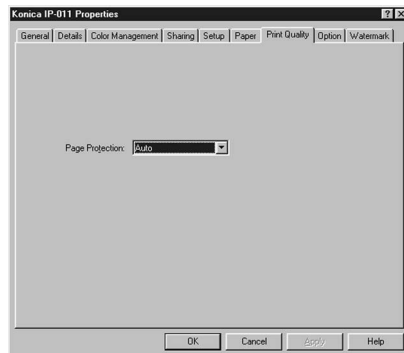

## Paper Tray

Select a paper tray you would like to use from the list shown by clicking the [▼] button beside [Setup] tab-[Paper Tray] box.

When [Auto Select] is selected, a paper tray with paper which a user specified from an application by using [Konica IP-011Properties] is automatically selected.

In order to use [A5], [B6R], set to [Bypass].

In addition, when the bypass tray is selected, you can select [OHT Film] from Paper Type of the [Paper] tab.

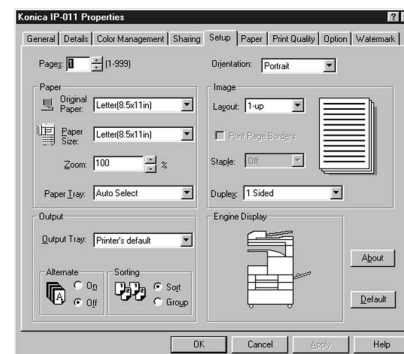

## Chapter 3 Printer Driver

### Paper Type

[Plain], [OHT Film], [OHT Interleaved] or [OHT Printed-Interleaved] can be selected from the list shown by clicking the [▼] button beside [Paper] tab- [Paper Type] box.

When Front/Back Cover is set, you can select only [Plain].

When [Tray 1], [Tray 2], [Tray 3] or [Tray 4] is selected by using [Setup] tab-[Paper]-[Paper Tray], [OHT Film] is not shown on the list.

When Paper Tray is set to [Bypass] and when [Sorting] is set to [Group], [OHT Interleaved] and [OHT Printed-Interleaved] are not shown on the list.

When the Duplex printing is set to settings other than [1 Sided], and when Staple is set to settings other than [Off], [OHT Film], [OHT Interleaved] or [OHT Printed-Interleaved] is not shown on the list.

### Port Settings

Click [Details] tab-[Port Settings] button to perform settings of the port selected on the [Print to the following port] box.

When the "LPT" is selected, the [Configure LPT Port] dialog is shown by clicking the [Port Settings] button. The following settings are performed on the [Configure LPT Port] dialog.

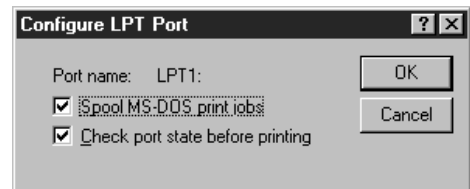

When [Spool MS-DOS print job] is selected, a MS-DOS print job is spooled.

When [Check port state before printing] is selected, the port status is checked before printing.

### Print Page Borders

Refer to Layout.

### Print Quality

Refer to Page Protection.

### Print Test Page

Click [General] tab-[Print Test Page] button to perform a test print.

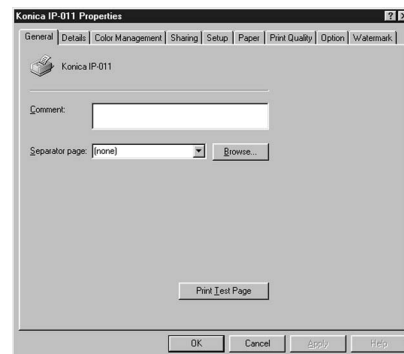

### Print to the following port

Select the port name of the IP-011 from the list shown by clicking the [▼] button beside [Details] tab-[Printing to the following port] box to change the printing port. Select a printing port from [COM1], [COM2], [FILE], [LPT1] or so on.

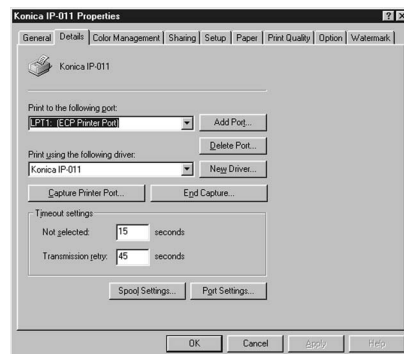

## Print using the following driver

Select the driver used for printing from the list shown by clicking the [▼] button beside [Details] tab-[Print using the following driver] box. When a driver is changed, settings of presently shown property are saved and the property of the newly selected driver will appear.

### S

## Setup-Original Paper

Select the original paper from the list shown by clicking the [▼] button beside [Setup] tab-[Paper]-[Original Paper] box.

The original paper you can select is as follows:

Paper Sizes to Be Selected	
A3	(297 x 420 mm)
A4	(210 x 297 mm)
A4R	(210 x 297 mm)
A5R	(148 x 210 mm)
B4	(257 x 364 mm)
B5	(182 x 257 mm)
B5R	(182 x 257 mm)
Ledger	(11 x 17 in)
Legal	(8.5 x 14 in)
Letter	(8.5 x 11 in)
LetterR	(8.5 x 11 in)
Statement	(5.5 x 8.5 in)
F4	(8.5 x 13 in)

Refer to the operating manual of the copier for paper sizes which can be used on each tray.

[\*\*R] indicates feeding the short edge of the paper. Document sizes not including “R” indicate feeding the long edge of the paper.

## Setup-Paper Size

When [Setup] tab-[Paper]-[Original Paper] is changed, [Setup] tab-[Paper]-[Paper Size] is automatically set to the same settings as [Original Paper].

You can select other paper sizes than that automatically set from the list shown by clicking the [▼] button beside [Paper Size].

Paper sizes which you can select are the same as those in the above-mentioned Paper-Original Paper.

Refer to the operating manual of the copier for paper sizes which can be used on each tray.

[\*\*R] indicates feeding the short edge of the paper. Document sizes not including [R] indicate feeding the long edge of the paper.

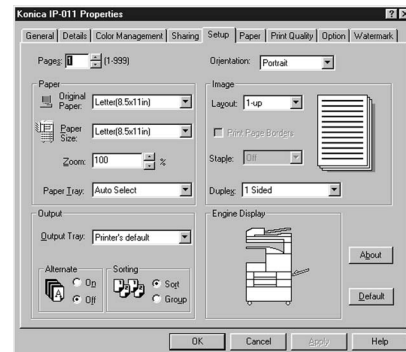

## Chapter 3 Printer Driver

### Settings of the two-way communication function (Spool Settings)

The [Spool Settings] dialog shown by clicking the [Details] tab-[Spool Settings] button enables you to perform settings of spooling and the bi-directional communication function.

When [Enable bi-directional support for this printer] is selected, the bi-directional communication is performed.

When [Disable bi-directional support for this printer] is selected, the bi-directional communication is not performed.

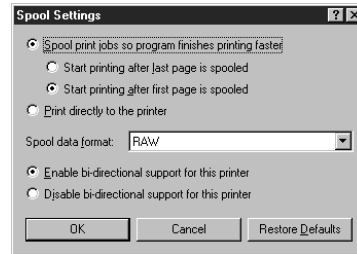

### Sharing

By using the [Sharing] tab, you can set to share a printer. Refer to the manual of Windows for printer sharing.

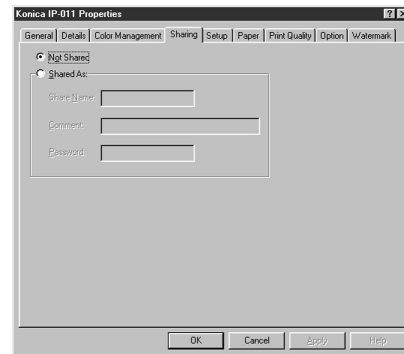

### Sorting

By using [Setup] tab-[Sorting], the method of sorting is set. Default of [Sorting] is [Sort].

When [Sort] is selected, after one copy of all pages has been printed, the second copy, the third copy, .... are printed.

When [Group] is selected, first, the required pieces of the first page are printed. Then, the required pieces of the second page, the third page, ..... are printed. [Group] can be selected by using [Setup] tab-[Sorting] when the following conditions are satisfied:

- When [OHT Interleaved] or [OHT Printed-Interleaved] is not selected in the [Paper] tab
- When Front/Back Cover are not set
- When the Staple setting is set to [Off]

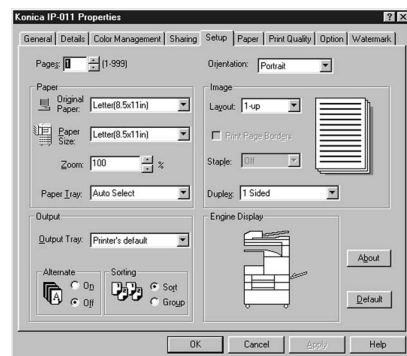



## Spool Settings

Set the method of spooling (temporary saving) the print data when it is sent to the printer on the [Spool Settings] dialog shown by clicking [Details] tab-[Spool Settings] button.

When [Spool print jobs so program finishes printing faster] is selected, Spool is set to on by default.

You may select either [Start printing after last page is spooled] or [Start printing after first page is spooled] as a method of spooling.

When [Start printing after last page is spooled] is selected, it is possible to edit other documents and start up other applications while printing, since print data is sent to a printer after the printing process of applications has been completed. When [Start printing after first page is spooled] is selected, print data is spooled one page by one page and sent to a printer. Although it takes more time that an application is released from the printing process, this method is suitable in the case that free space for spooling in your hard disk is small.

Select [Spool data format] from among EMF or RAW.

When [Print directly to the printer] is selected, a print job is directly sent to a printer without spooling it.

You can also perform settings of the bi-directional communication function when setting spooling.

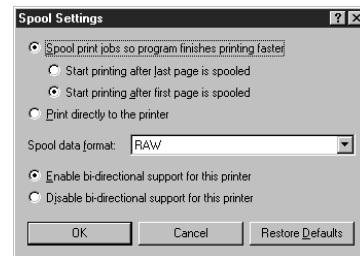
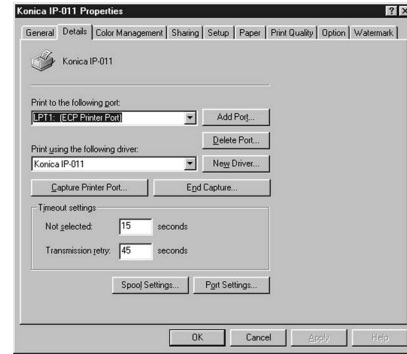

## Staple

Set the position of staples from the list shown by clicking the [▼] button beside [Setup] tab-[Staple] box.

You can select the staple setting from [Off], [1-left], [1-right], [2-left], or [2-top].

Default is [Off].

However, the staple setting can not be performed in the following cases:

- When [2 Trays], [3 Trays] or [4 Trays] are not selected in the Finisher setting, or when they are not installed
- When [Group] is selected in the [Sorting]
- When [B6R] is selected in the [Paper Size]
- When [OHT Film], [OHT Interleaved] or [OHT Printed-Interleaved] is selected in the [Paper Type]
- When [Booklet] is selected in the [Duplex]
- The following combination is selected:  
e.g., A3-size paper (Portrait) and 2-left stapling

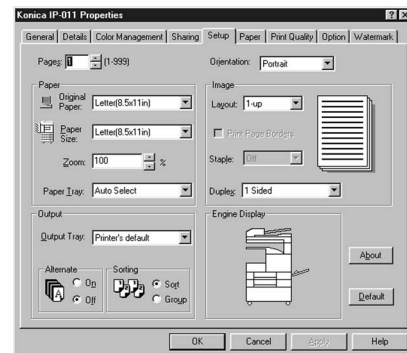

## Chapter 3 Printer Driver

In addition, when Staple is specified, you can't select Alternate.  
You can't staple at two positions for the paper of B5R or smaller.  
Stapling is performed in accordance with orientations as follows:

1- left (Portrait)

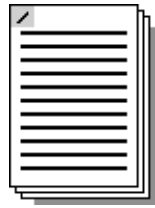

1- left (Landscape)

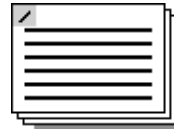

1- right (Portrait)

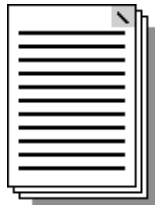

1- right (Landscape)

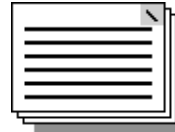

2- left (Portrait)



2- left (Landscape)



2- top (Portrait)



2- top (Landscape)



### T

#### Timeout settings

By using [Details] tab-[Timeout settings], the timeout value is set.

The [Not selected] box indicates the number it will take in seconds for a printer to become available for printing, from the time the computer starts outputting print data. If the waiting time exceeds value set, a printer error is shown and the job is automatically cancelled.

The [Transmission retry] box is used to set the amount of time in seconds until a printer to become available for printing allowing a computer that failed to output once to output the print data again. If the waiting time exceeds this set value, a printer error is shown and the job is automatically cancelled.

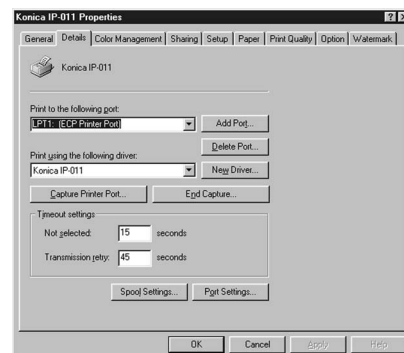

## W

## Watermark

Selecting a watermark from the list of the [Watermark] tab enables you to print documents with a watermark.

When the Printer Driver is installed, the basic watermarks are installed at the same time. In this condition, you can select a watermark from [(None)], [CONFIDENTIAL], [COPY], [DRAFT], [FILE COPY], [FINAL], [PROOF] or [TOP SECRET]. Default of watermark is [(None)].

On the [Edit/Add Watermark] dialog shown by clicking the [Add] button, you can create up to 50 watermarks with characters a user specifies.

If the number of watermarks exceeds 50, the [Add] button becomes disable. In addition, the number of characters a user can specify to create one watermark is 72 or less.

On the [Edit/Add Watermark] dialog shown by clicking the [Edit] button, you can edit existing watermarks.

You can delete watermarks by selecting them from the list and clicking the [Delete] button.

When [First Page Only] is selected, you can print a watermark on the first page of documents only.

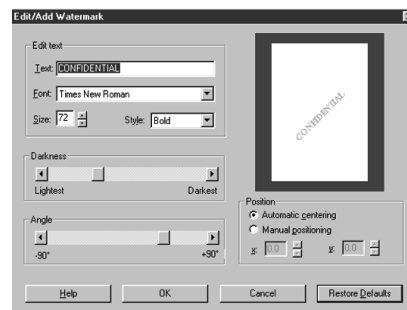
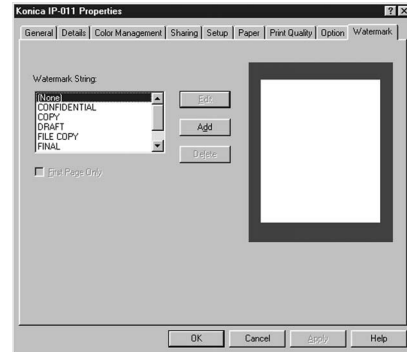

## Z

## Zoom

In order to change the print size of documents, you can select the size of print in 1% by using [Setup] tab-[Zoom] box.

Default of Zoom is [100]%.

The value can be specified from between 25% and 400%.

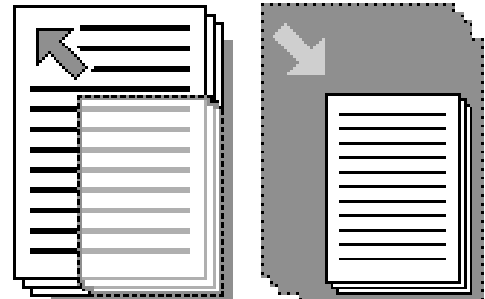

# Chapter 4 Control Panel Setup

■ Contents of This Chapter .....	4-2
■ About the Control Panel .....	4-3
● The Control Panel of the Printer/Copier .....	4-3
● How to Enter Settings on the LCD Touch Screen .....	4-4
● Printer Mode Basic Screen .....	4-5
● Printer Menu Screen .....	4-5
● Printer Setting Screen .....	4-6
● Procedures of the Printer Setting .....	4-7
■ Configuration of Printer Setting Menu .....	4-9
■ Functions of the Printer Setting .....	4-11
● Network Setup .....	4-11
● Select Language .....	4-11
● Print Quality .....	4-12
● I/O Timeout .....	4-12
● Test Print .....	4-13
● CMD Error Page .....	4-13
● Error Page .....	4-13
● Factory Default .....	4-14
● Help .....	4-14

## Chapter 4 Control Panel Setup

---

### ■ Contents of This Chapter

In this chapter describes the printer mode basic screen and the setup menu of the Control Panel of the Printer/Copier. Refer to the operating manual of the copier for other functions and screens of the Control Panel.

Refer to “Chapter 2 Setup ■ Print from Applications” (p. 2-19) for how to use the Printer Driver from applications, “Chapter 3 Printer Driver” (p. 3-1) for how to set the printer from the Printer Driver and “Chapter 5 Status Monitor and Control Panel” (p. 5-1) for how to set the printer from the Printer Tools.

## ■ About the Control Panel

### ● The Control Panel of the Printer/Copier

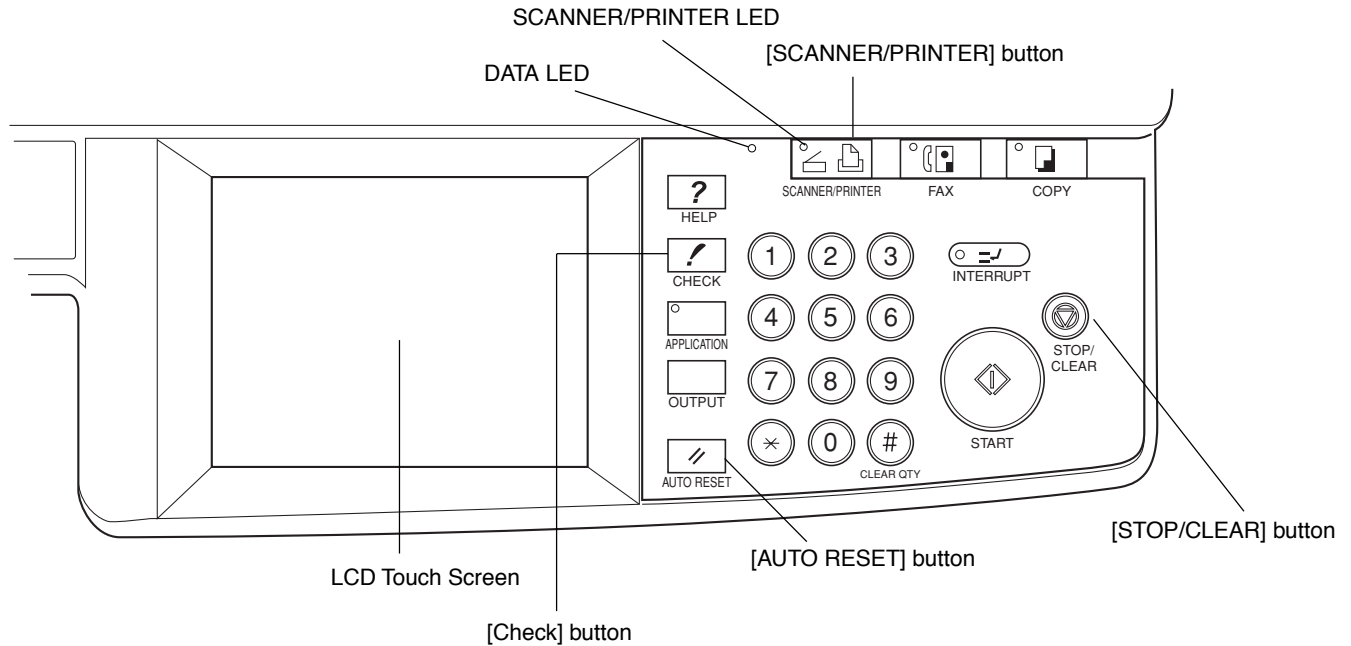

#### [SCANNER/PRINTER] button

Switches to the printer mode.

#### LCD Touch Screen

Displays the status of the Print Controller, menus related to settings and options to be selected are displayed on the LCD.

#### [CHECK] button

Displays the setting CHECK screen of the copier on the LCD.

#### [AUTO RESET] button

Resets settings of the copier to default settings.

#### [STOP/CLEAR] button

Cancels the currently processing copy or print process.

#### DATA LED

This LED flashes in green when the Print Engine is receiving data.

Not when the Print Engine is receiving data, but when data is saved in memory of the Print Engine, this LED is steadily lit.

#### SCANNER/PRINTER LED

This LED is turned on in green in the printer mode and is turned on in red when a warning message or an error message is issued. In such a case, the print process is interrupted. Operations by an operator or a service is required. Check the error information on the LCD. When the cause of the error is removed, the print process starts again.

## Chapter 4 Control Panel Setup

### ● How to Enter Settings on the LCD Touch Screen

You can enter settings from the printer mode basic screen shown on the LCD Touch Screen by using either the item selection or the information entry.

#### Item Selection

In this method, various settings are performed by selecting a button with a number which corresponds to the item you would like to select on the LCD.



#### Information Entry

In this method, a printer name or a set value is entered by selecting alphabets or numbers shown on buttons of the LCD.



#### Currently Selected Items

Currently selected items are indicated with a "+" mark.

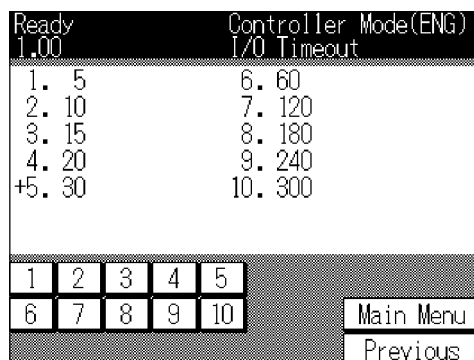

## ● Printer Mode Basic Screen

When the Konica 7020 series + IP-011 system starts properly, the printer mode basic screen is displayed on the LCD by pressing the [SCANNER/PRINTER] button.

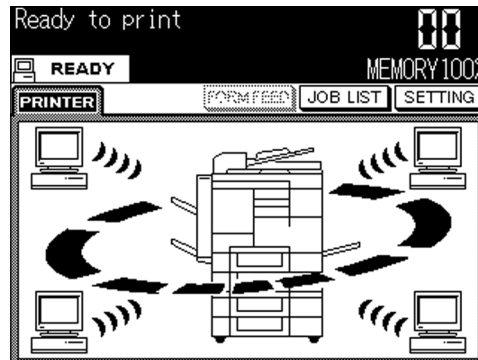

## ● Printer Menu Screen

The following printer menu screen is displayed by pressing the [SETTING] key on the printer mode basic screen.



When the [SCANNER/PRINTER] button is pressed again, the LCD is changed to the copy mode basic screen, and the normal copy settings becomes available.

### [1. Setting]

The Printer Setting screen is displayed by pressing the [1] button. On the Printer Setting screen, you can perform various settings related to the Print Controller.

### [2. Cancel Job]

You can cancel the print command currently being processed by pressing the [2] button.

### [3. Detail Message]

Information related to the printer setting is displayed on the LCD by pressing the [3] button.



## Chapter 4 Control Panel Setup

---

### ● Printer Setting Screen

When "1. Setting" on the printer menu screen is selected, the printer setting screen is displayed.

When an item is selected on the printer setting screen, each setting screen corresponding to the selected item is displayed.

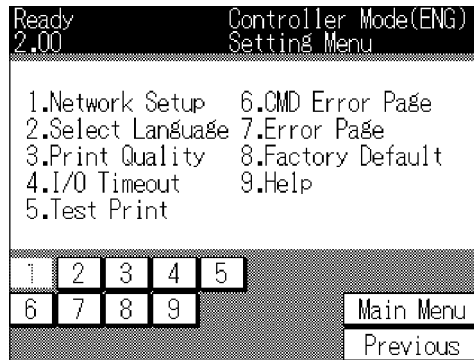

Buttons commonly used among setting screens are as follows:

#### [Main Menu]

Pressing the [Main menu] button returns to the printer menu screen.

After settings have been changed, when the [Main Menu] button is pressed, the save confirmation screen is displayed.

#### [Previous]

Pressing the [Previous] button returns to the previous setting screen.

After settings have been changed, when the [Previous] button is pressed, the save confirmation screen is displayed.

#### Numeric keys

In order to select an item on the screen, press a numeric key corresponding to a number of the item you would like to select.

In addition, when you are required to enter a value, press numeric keys to enter the value.

Press the [Main Menu] or [Previous] button to show the save confirmation screen. Then, press the [Yes] button to save the settings. Press the [No] button not to save the settings.

## ● Procedures of the Printer Setting

The following show the procedures of the printer setting by using the LCD Touch Screen:

1. Press the [SCANNER/PRINTER] button to show the printer mode basic screen.

The copy mode basic screen is switched to the printer mode basic screen.

Press the [SETTING] key to show the printer menu screen.

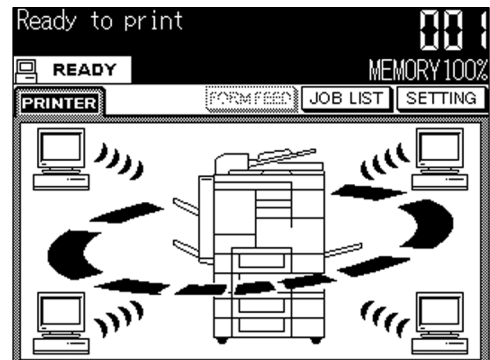

2. Press the numeric key [1] to select [1.Setting].

The printer mode basic screen is switched to the printer menu screen.



3. Press the numeric key corresponding to a number of the item you would like to select.

The setting screen of the selected item is displayed.

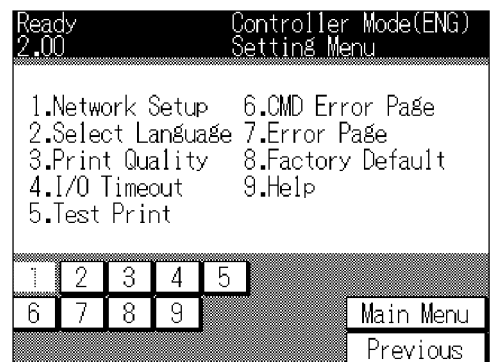

4. Continue the setting by pressing the numeric key corresponding to a number of the item you would like to select.

5. Press the [Previous] button to return to the previous setting screen.

Press the [Main Menu] button to return to the printer menu screen.

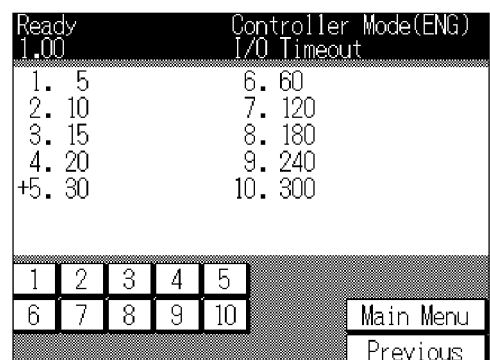

## Chapter 4 Control Panel Setup

---

6. Press the [Yes] button on the save preservation confirmation screen show by pressing the [Main Menu] or [Previous] button to save new settings.  
Press the [No] button not to save the settings.

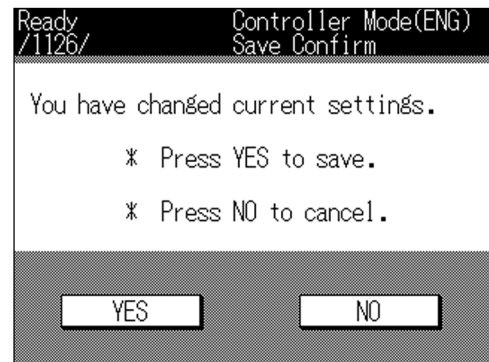

Refer to “ ■ Configuration of Printer Setting Menu ” (p. 4-9) for configuring the printer setting menu.

Refer to “ ■ Functions of the Printer Setting ” (p. 4-11) for the printer setting details.

## ■ Configuration of Printer Setting Menu

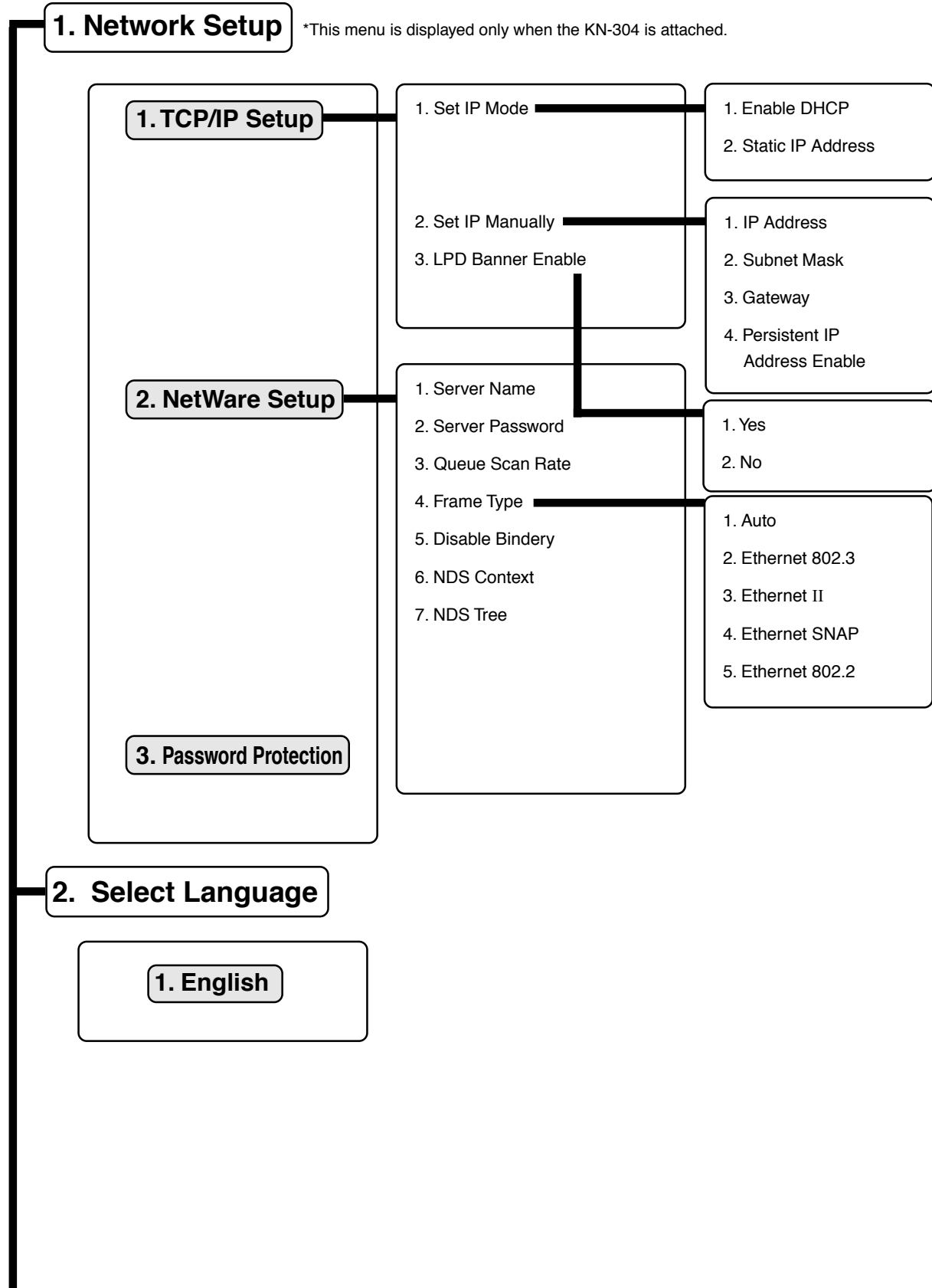

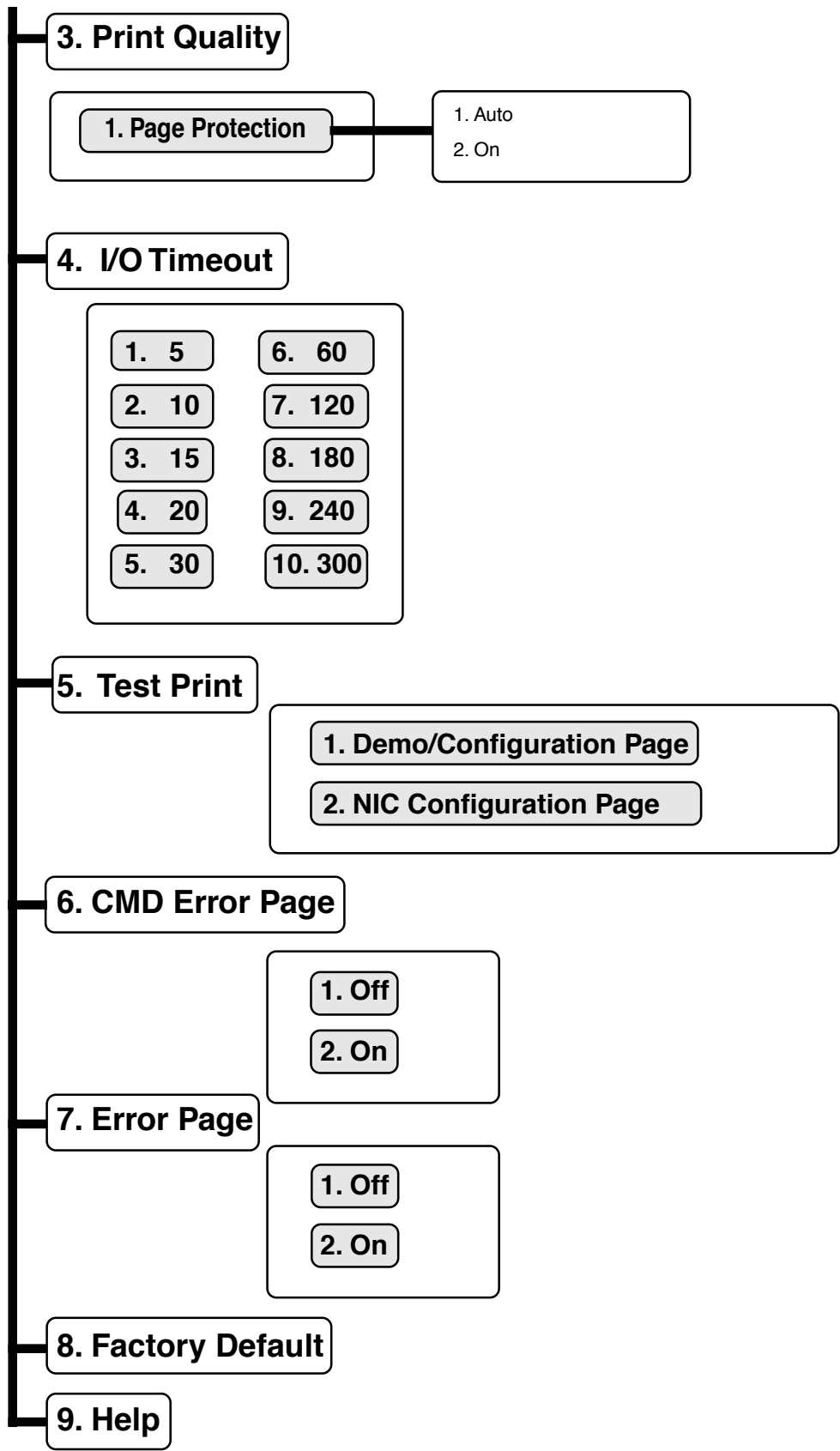

---

## ■ Functions of the Printer Setting

### ● Network Setup

Select [1. Setting]-[1. Network Setup] on the Printer Setting screen to display the network setup screen. [1. Network Setup] is displayed only when the KN-304 is attached.

Items of the network setup screen are as follows: Refer to the operating manual of the KN-304 for details of the network connection.

#### [1. TCP/IP Setup]

Press [1] to display the TCP/IP Setup screen. IP Address, Subnet Mask, Gateway, Enable DHCP and Enable LPD Banner can be set on the TCP/IP Setup screen.

#### [2. NetWare Setup]

Press [2] to display the NetWare Setup screen. Server Name, Server Password, Queue Scan Rate, Frame Type, Disable Bindery, NDS Context and NDS Tree can be set on the NetWare Setup screen.

#### [3. Password Protection]

Press [3] to display the Password Protection screen. A password used for the network setup can be set and changed.

### ● Select Language

Select [1. Setting]-[2. Select Language] on the Printer Setting screen to display the Select Language screen.

#### [1. English]

Press [1] to set the system language to English.

## Chapter 4 Control Panel Setup

---

### ● Print Quality

Select [1. Setting]-[3. Print Quality] on the Printer Setting screen to display the Print Quality Setup screen.

Items of the Print Quality Setup screen are as follows:

#### [1. Page Protection]

Press [1] to display the Page Protection Setup screen. You can set to [1. Auto] or [2. On] on the Page Protection Setup screen. The factory default is [1. Auto].

### ● I/O Timeout

Select [1. Setting]-[4. I/O Timeout] on the Printer Setting screen to display the I/O Timeout Setup screen. The factory default is [5. 30].

Items of the I/O Timeout Setup screen are as follows:

#### [1. 5]

Press [1] to set the I/O Timeout value to 5 seconds.

#### [2. 10]

Press [2] to set the I/O Timeout value to 10 seconds.

#### [3. 15]

Press [3] to set the I/O Timeout value to 15 seconds.

#### [4. 20]

Press [4] to set the I/O Timeout value to 20 seconds.

#### [5. 30]

Press [5] to set the I/O Timeout value to 30 seconds.

#### [6. 60]

Press [6] to set the I/O Timeout value to 60 seconds.

#### [7. 120]

Press [7] to set the I/O Timeout value to 120 seconds.

#### [8. 180]

Press [8] to set the I/O Timeout value to 180 seconds.

#### [9. 240]

Press [9] to set the I/O Timeout value to 240 seconds.

#### [10. 300]

Press [10] to set the I/O Timeout value to 300 seconds.

## ● Test Print

Select [1. Setting]-[5. Test Print] on the Printer Setting screen to display the Test Print Setup screen.

Items of the Test Print Setup screen are as follows:

### [1. Demo/Configuration Page]

Press [1] to print the Demo/Configuration Page immediately.

Items of the Demo/Configuration Page are as follows:

- Version information (Printer Driver/Network card: only when the KN-304 is attached)
- Current settings (Engine Destination / Resolution / Print Speed / Default Paper Size / Default Paper Tray / Finisher / Optional Paper Tray / Timeout Setting)
- Paper (Tray 1 / Tray 2 / Tray 3 / Tray 4 / Bypass Tray)
- Device status (Controller Memory / Free Memory)
- Miscellaneous (Total Page count / Printer page count)

### [2. NIC Configuration Page]

Press [2] to print the NIC Configuration Page immediately. [2. NIC Configuration Page] is displayed only when the KN-304 is attached.

Refer to the operating manual of the KN-304 for details of the NIC Configuration Page.

## ● CMD Error Page

Select [1. Settings]-[6. CMD Error Page] on the printer mode basic screen to display the CMD Error page Setup menu.

Items of the CMD Error page Setup menu are as follows and the factory default is [1.Off].

### [1. Off]

When [1] is selected, a CMD error page is not printed in the case that the printer command error occurs.

### [2. On]

When [2] is selected, a CMD error page is automatically printed in the case that the printer command error occurs.

## ● Error Page

Select [1. Settings]-[7. Error Page] on the printer mode basic screen to display the Error page Setup menu.

Items of the Error page Setup menu are as follows and the factory default is [1.Off].

### [1. Off]

When [1] is selected, an error page is not printed in the case that the I/O timeout error occurs.

### [2. On]

When [2] is selected, an error page is automatically printed in the case that the I/O timeout error occurs.



## Chapter 4 Control Panel Setup

---

### ● Factory Default

Select [1. Setting]-[8. Factory Default] on the printer mode basic screen to return various settings to the factory default.

Items of the Factory Default are as follows:

[Language]: English

[Smoothing]: Off

[Page Protection]: Auto

[I/O Timeout]: 30

\*Refer to the operating manual of the KN-304 for details of Factory Default of the Network Setup.

### ● Help

Select [1. Setting]-[9. Help] on the printer mode basic screen to display the help screen.

[<<][>>]

Press [<<][>>] to display the previous or the next Help screen on the LCD.

## Chapter 5 Status Monitor and Control Panel

■ Contents of This Chapter .....	5-2
■ Status Monitor and Control Panel .....	5-3
● About the Status Monitor .....	5-3
● About the Control Panel .....	5-3
■ Working Environment .....	5-4
● Compliant OS .....	5-4
● Interface .....	5-4
■ How to Install .....	5-4
■ How to Operate the Status Monitor .....	5-5
● Starting the Status Monitor .....	5-5
● Finishing the Status Monitor .....	5-5
● Restarting the Status Monitor .....	5-5
● Show/Hide the Status Monitor .....	5-6
● Display Change .....	5-7
■ How to Operate the Control Panel .....	5-8
● Starting the Control Panel .....	5-8
● Finishing the Control Panel .....	5-8
● Buttons of the Control Panel .....	5-9
● Settings of Paper .....	5-10
● Printer Setting .....	5-11
● Test Print .....	5-12
● Confirmation of Configurations .....	5-12

## Chapter 5 Status Monitor and Control Panel

---

### ■ Contents of This Chapter

Printer Tools is the generic name for two programs, "Status Monitor" and "Control Panel." This chapter describes how to use these programs on computers connected to the 7020 series + IP-011 system. These programs enable you to monitor printer status and change printer settings.

Refer to "Chapter 2 Setup" (p. 2-1) for instructions on setting the printer from applications, "Chapter 3 Printer Driver" (p. 3-1) for instructions on installing the printer from the Printer Driver and "Chapter 4 Control Panel Setup" (p. 4-1) for instructions on setting the printer from the Control Panel.

## ■ Status Monitor and Control Panel

The Printer Tools is the generic name of two programs, “Status Monitor” and “Control Panel” which are used on computers connected to the Konica 7020 series + IP-011 system.

### ● About the Status Monitor

The Status Monitor is a program which enables you to monitor the printer status from computers connected to the Konica 7020 series + IP-011 system.

If, at the time of installing the Printer Tools, Status Monitor is set to automatically start, the Status Monitor automatically starts and the Status Monitor icon is displayed on the task bar when a computer is started.

The Status Monitor displays information about the printer status which has been received from the IP-011 in the form of easy-to-understand images and messages. Additionally, in the event that any problems occur on the printer side, the method of recovery is displayed on the Status Monitor.

Moreover, background colors of the Status Monitor icon on the task bar change in accordance with the printer status.



- Printer is ready / Printing / Canceling printing / Setting printer: Blue
- Error: Red
- No paper, Warming up: Yellow

### ● About the Control Panel

The Control Panel is a program to set the printer and used on computers connected to the Konica 7020 series + IP-011 system.

Select [Printer Setting] by clicking it on the [Setup] menu of “Status Monitor” to start the Control Panel.

The Control Panel is made of the [Paper] tab, [Printer Setting] tab, [Test Print] tab and [Configuration] tab.

#### **[Paper] tab**

Sets Paper Size, Paper Tray, Output Tray, Orientation (Portrait / Landscape) and Copies.

#### **[Printer Setting] tab**

Sets Page Protection, I/O Time Out, Line/Page, Language and Smoothing.

#### **[Test Print] tab**

Prints the Demo/Configuration Page or the NIC Status.

#### **[Configuration] tab**

Check the setting status of the printer name, free memory, option, etc.

### ■ Working Environment

#### ● Compliant OS

The Status Monitor and the Control Panel can be used on the following OS:

Windows 95

Windows 98

Windows Me

Windows NT4.0 (Service Pack 3 or later)

Windows 2000

Windows XP

#### ● Interface

The interface which the Status Monitor and the Control Panel use is as follows:

IEEE 1284 (Compatible mode, Nibble or ECP)

### ■ How to Install

When executing "Setup.exe" held in the CD-ROM to install the printer driver, you can make a choice to install Status Monitor and Control Panel simultaneously with the printer driver.

Refer to "Chapter 2 Setup" (p. 2-1) for installation of the Printer Driver.

## ■ How to Operate the Status Monitor

### ● Starting the Status Monitor

1. If, at the time of installing the Printer Tools, Status Monitor is set to automatically start, the Status Monitor automatically starts when a computer starts.

Immediately after the [Konica IP-011 Status Monitor] window has been displayed, the printer status is checked.



### ● Finishing the Status Monitor

1. Click [View] menu-[Exit] on the [Konica IP-011 Status Monitor] window.



### ● Restarting the Status Monitor

1. Click [Start]-[Program]-[Konica IP-011]-[Konica IP-011 Printer Tools] to start the Status Monitor again after you have exited from the Status Monitor.



Immediately after the [Konica IP-011 Status Monitor] window has been displayed, the printer status is checked.



## Chapter 5 Status Monitor and Control Panel

---

### ● Show/Hide the Status Monitor

1. When the [Close] button is clicked when the Status Monitor is displayed, the Status Monitor is hidden (displayed as an icon on the task bar).
2. When the Status Monitor icon on the task bar is clicked when the Status Monitor is hidden, the Status Monitor is displayed.



When an error occurs in communication with the printer, a confirmation message is displayed. Click the [OK] button of the confirmation message and check the connection to the printer.



## ● Display Change

Display of the Status Monitor can be selected from either [Expand] or [Reduce]. Normally, the Status Monitor starts in the [Reduce] display.

In the [Expand] display, when a problem related to the printer occurs and information related to the problem is shown on the Status Monitor, the position of the problem is indicated by using an image and a method of recovery is displayed in the How to Recover list. Switch the display of the Status Monitor if necessary.

### Expanding the Display

1. Select [Expand] from the [View] menu.

The [Konica IP-011 Status Monitor] window is expanded.

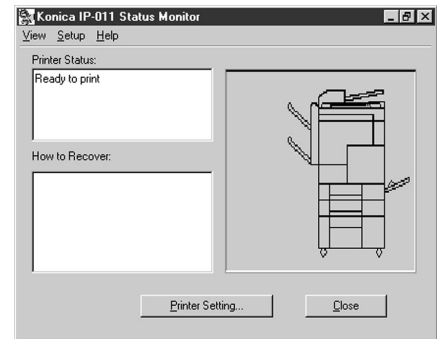
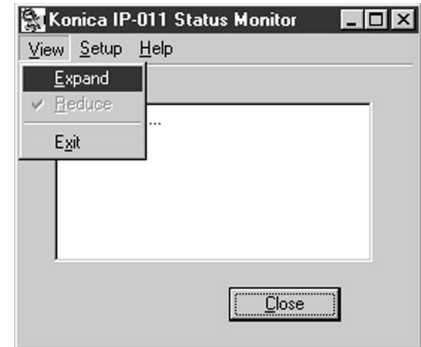

### Reducing the Display

1. Select [Reduce] from the [View] menu.

The [Konica IP-011 Status Monitor] window is reduced.

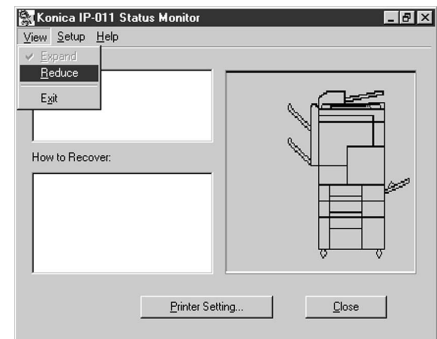



### ■ How to Operate the Control Panel

#### ● Starting the Control Panel

1. Select [Printer Setting] from the [Setup] menu of the Status Monitor window.
2. The [Konica IP-011 Control Panel] dialog is displayed.

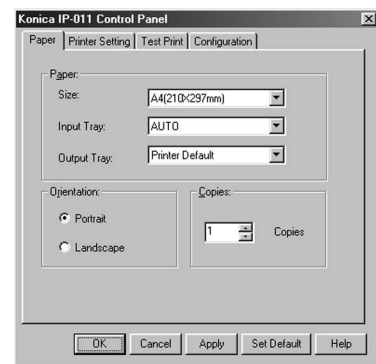

#### ● Finishing the Control Panel

1. Click the [OK] button to send data of settings to the printer.  
The [Konica IP-011 Control Panel] dialog is closed and the [Konica IP-011 Status Monitor] window is displayed.
2. Click the [Cancel] button not to perform settings.  
The [Konica IP-011 Control Panel] dialog is closed and the [Konica IP-011 Status Monitor] window is displayed.

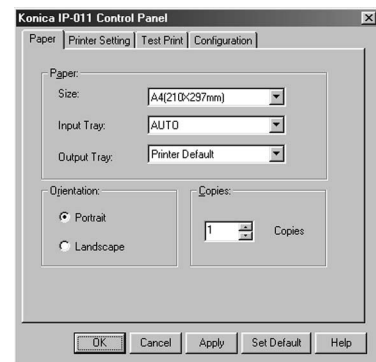

## ● Buttons of the Control Panel

### [OK]

When the [OK] button is clicked, data of all settings of the tab is sent to the printer. Then, the [Konica IP-011 Control Panel] dialog is closed and the [Konica IP-011 Status Monitor] window is displayed.

### [Cancel]

When the [Cancel] button is clicked, the [Konica IP-011 Control Panel] dialog is closed and the [Konica IP-011 Status Monitor] window is displayed.

### [Apply]

When the [Apply] button is clicked, data of present settings of the tab is sent to the printer. This button is used to continue to perform settings of other tabs.

### [Set Default]

When the [Set Default] button is clicked, default settings are displayed.

### [Help]

When the [Help] button is clicked, Help of the [Konica IP-011 Control Panel] dialog is displayed.



When an error occurs in communication with the printer, a confirmation message is displayed. Click the [OK] button of the confirmation message and check the connection to the printer. Then, perform settings on the [Konica IP-011 Control Panel] again.



## Chapter 5 Status Monitor and Control Panel

---

### ● Settings of Paper

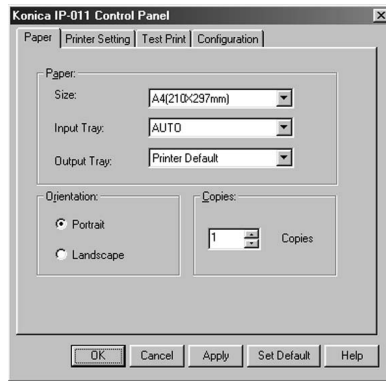

1. Click the [Paper] tab of the [Konica IP-011 Control Panel] dialog.  
The [Paper] tab of the [Konica IP-011 Control Panel] dialog is displayed.
2. On the list shown by clicking the [▼] button beside [Size], [Input Tray] and [Output Tray] of the [Paper] group box, select an item you desire respectively.
3. Click either [Portrait] or [Landscape] from the [Orientation] group box.
4. Set the number of copies you desire to print by clicking the [▲] or [▼] button or directly entering the number on the box of the [Copies] group box.
5. Check the settings.
6. Click the [OK] button when you do not continue to perform settings of other tabs.
7. Click the [Apply] button when you continue to perform settings of other tabs and register settings of the [Paper] tab before moving to other tabs.
8. Click the desired tabs, when you continue to perform settings of other tabs.

## ● Printer Setting

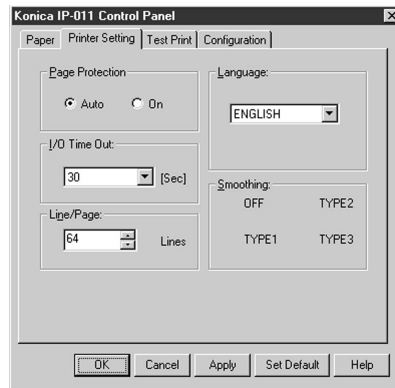

1. Click the [Printer Setting] tab of the [Konica IP-011 Control Panel] dialog.  
The [Printer Setting] tab of the [Konica IP-011 Control Panel] dialog is displayed.
2. Click either [Auto] or [On] of the [Page Protection] group box.
3. Select the desired item on the list shown by clicking the [▼] button of the [I/O Time Out] Group Box. The printer waits for entry of data during time (second) you selected in this box. In the case that data is not entered within the set I/O Time Out time, the printer automatically cancels a job.
4. Set the number of lines you desire to print on one page in the box of the [Line/Page] group by clicking the [▲] or [▼] button or directly entering the number. You can set the value from between 5 and 128.
5. Select the desired item from the list shown by clicking the [▼] button of the [Language] group box.
6. Confirm the settings.
7. Click the [OK] button when you do not continue to perform settings of other tabs.
8. Click the [Apply] button when you continue to perform settings of other tabs and register settings of the [Paper] tab before moving to other tabs.
9. Click the desired tabs, when you continue to perform settings of other tabs.

## Chapter 5 Status Monitor and Control Panel

---

### ● Test Print

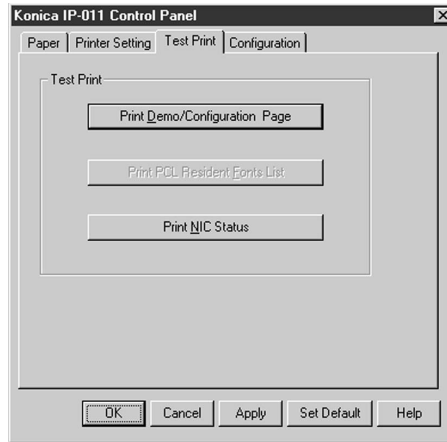

1. Click the [Test Print] tab of the [Konica IP-011 Control Panel] dialog.  
The [Test Print] tab of the [Konica IP-011 Control Panel] dialog is displayed.
2. Click the [Print Demo/Configuration Page] button to print the Print Demo/Configuration Page.  
Click the [Print NIC Status] button to print the NIC Status Page.
3. Click the [OK] button.
4. Click the [OK] button when you do not continue to perform settings of other tabs.
5. Click the desired tab when you continue to perform settings of other tabs.

### ● Confirmation of Configurations

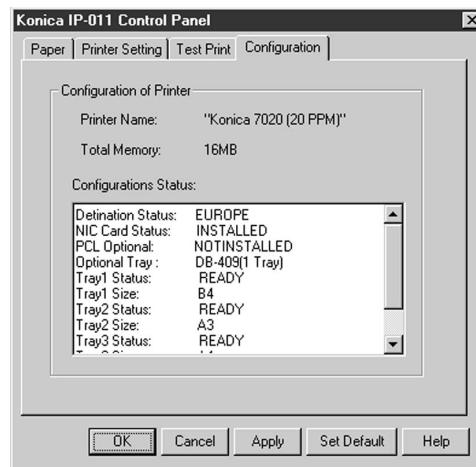

1. Click the [Configuration] tab of the [Konica IP-011 Control Panel] dialog.  
The [Configuration] tab of the [Konica IP-011 Control Panel] dialog is displayed.
2. Confirm the shown printer name, free memory and setting status.
3. Click the [OK] button when you do not continue to perform settings of other tabs.
4. Click the desired tab when you continue to perform settings of other tabs.

# Appendix A Troubleshooting

■ Error Message .....	Appendix A-2
■ Basic Troubleshooting .....	Appendix A-3
■ General Problems of Printing .....	Appendix A-3
● The “OHT Film” is not selectable.....	Appendix A-3
● The Printer Controller does not respond to the “Print” command. ....	Appendix A-3
● A message to demand a paper size which you do not use is displayed. ....	Appendix A-4
● You can not print the test print .....	Appendix A-4
● The print setting of a job does not correspond to the result of printing. ....	Appendix A-5
● The “Duplex” option is not displayed. ....	Appendix A-5
● Memory Error / Memory Overflow / Overrun .....	Appendix A-5

# Appendix A Troubleshooting

## ■ Error Message

The error messages shown on the Status Monitor are as follows:

Error Message	How to Recover
Mishandled paper in ADU	Please remove paper according to the message screen of printer
DB Upper Tray is not ready	Please insert DB Upper Tray
DB Lower Tray is not ready	Please insert DB Lower Tray
Mishandled paper in DB Lower Tray	Please remove paper according to the message screen of printer
No paper in DB Lower Tray	Please load paper in DB Lower Tray
DB Lower Tray is not available	Please confirm the printer setting
No paper in DB Upper Tray	Please load paper in DB Upper Tray
DB Upper Tray is not available	Please confirm the printer setting
DB door is open	Please close DB door
LCT is not ready	Please insert LCT
Mishandled paper in LCT	Please remove paper according to the message screen of printer
No paper in LCT	Please load paper in LCT
LCT is not available	Please confirm the printer setting
Mishandled paper in RADF	Please remove original according to the message screen of the printer
RADF Failure	Please dispose the trouble according to the message screen of the printer
RADF Communication Error	Please dispose the trouble according to the message screen of the printer
OverRun	Please dispose the trouble according to the User Reference Guide.
System Failure	Please dispose the trouble according to the message screen of the printer
System Communication Error	Please dispose the trouble according to the message screen of the printer
Finisher Front door is open	Please close Finisher Front door
Stapler cartridge is not loaded	Please confirm the stapler cartridge
There are no staples	Please replace staple cartridge
No Toner	Please add toner
Low Toner	Please add toner
Toner bottle does not exist	Please install the Toner bottle
NIC I/F Error	Please dispose the trouble according to the User Reference Guide.
Mishandled paper in Finisher	Please remove paper according to the message screen of printer
Finisher conveyance door is open	Please close Finisher Conveyance Door
Finisher does not work correctly	Please dispose the trouble according to the message screen of the printer
Mishandled paper in Finisher	Please remove paper according to the message screen of printer
Printing Paused due to some interruptions.	Please wait. If this situation continues, please check printer.
Printer Controller NVRAM Error	Please dispose the trouble according to the User Reference Guide.
Printer Controller SIMM Error	Please dispose the trouble according to the User Reference Guide.
Printer Controller Memory Error	Please dispose the trouble according to the User Reference Guide.
Printer Memory Overflow	Please dispose the trouble according to the User Reference Guide.
Printing Paused Due to No Paper	Please load paper
Main Lower Tray is not ready	Please insert Main Lower tray
No paper in DB Lower Tray	Please load paper in DB Lower Tray
DB Lower Tray is not available	Please confirm the printer setting
Optics Failure	Please dispose the trouble according to the message screen of the printer
Optics Communication Error	Please dispose the trouble according to the message screen of the printer
Mishandled paper	Please remove paper according to the message screen of printer
Bypass Tray is not ready	Please open Bypass tray
No paper in Bypass Tray	Please load paper in Bypass tray
Bypass Tray is not available	Please confirm the printer setting
Main Upper Tray is not ready	Please insert Main Upper tray
No paper in Main Upper Tray	Please load paper in Main Upper Tray
Main Upper Tray is not available	Please confirm the printer setting
Side door is open	Please close Side door
PM required	Please call service for PM
Printing Paused due to the limit of Fixing-unit-counter	Please replace the Fixing unit
Density declines	Please solve the trouble according to the User Reference Guide
Output Tray 1 is overloaded	Remove copies from the Output Tray 1
Output Tray 2 is overloaded	Remove copies from the Output Tray 2
Output Tray 3 is overloaded	Remove copies from the Output Tray 3
Output Tray 4 is overloaded	Remove copies from the Output Tray 4
Exit Tray is overloaded	Remove copies from the Exit Tray
Printer Failure	Please dispose the trouble according to the message screen of the printer
Printer Communication Error	Please dispose the trouble according to the message screen of the printer
Actual paper size is different from setting	Please confirm the paper

## ■ Basic Troubleshooting

This section describes how to troubleshoot. If troubles are not removed by using the following countermeasures, contact a service provider.

There are some basic conditions which cause various abnormalities. Before taking a trouble as a special case, first refer to the following basic countermeasures.

1. Check the power of the copier and computers and cable connections.
2. Check the LCD of the copier to find information concerning the current trouble.
3. If possible, print the “Test Print” to check that the settings are appropriate.
4. Check the current status of the Print Controller.

Check the current status shown on the LCD of the Control Panel.

Press the [SCANNER/PRINTER] button and press [3. Detail Message] of the printer mode basic screen to check the job status.

Additionally, check the Status Monitor. You can find if the Print Controller is processing your job or not on the status message. When your job is not displayed on the status message, it is considered that the Print Controller has already finished printing your job.

When your job is being processed or waiting for being printed, the current status is displayed on the dialog shown by double-clicking [Start]-[Settings]-[Printers]-[Konica IP-011].

## ■ General Problems of Printing

### ● The “OHT Film” is not selectable.

1. Select a bypass tray with which OHT can be used.

### ● The Print Controller does not respond to the “Print” command.

1. Check that [Konica IP-011] is selected as a current printer.  
It is required to select [Konica IP-011] as a present printer on Windows before printing.
2. Check that the power switch of the copier is turned on.
3. Print the “Test Print”.

When you can not print a job from a computer even though you can print a test print, contact a system administrator or a service provider.



## Appendix A Troubleshooting

---

- A message to demand a paper size which you do not use is displayed.

1. Cancel the job to change the paper size of “Page (Paper) Setup” dialog on an application.

- You can not print the test print.

1. Check the LCD of the copier Control Panel.

When “Ready to copy” is displayed on the LCD, go to the Step 3.

When a diagnosis message or an error message is displayed on the LCD, refer to the operating manual of the copier.

When the LCD is blank, go to the Step 2.

2. Press the sub power sw on the Control Panel.

When the copier is used in the Power Save mode, press this switch to show the LCD in the Display mode.

3. Try to make a copy.

When copy is available, go to the Step 4.

4. Turn off the copier and restart it. Print the test print again after the Print Controller is ready.

Contact a service provider when you can not print the test print after taking the above-mentioned procedures.

● The print setting of a job does not correspond to the result of printing.

1. Check that the printer setting is not changed.

Refer to “Chapter 5 Status Monitor and Control Panel ● Printer Setting”(p. 5-11) or “Chapter 3 Printer Driver ■ Printer Driver Function List”(p. 3-5) for the printer setting.

● The “Duplex” option is not displayed.

1. Check that, [B6R] is not selected as a paper size.

● Memory Error / Memory Overflow / Overrun

1. Set the Page Protection.

Refer to “Chapter 3 Printer Driver ■ Printer Driver Function List” (p. 3-5) or “Chapter 4 Control Panel Setup ● Print Quality” (p. 4-12) for the page protection.

2. Expand memory.

Memory of the IP-011 can be expanded up to 80 MB. Contact a service provider for details of the memory expansion.

# Appendix B Product Specifications

■ Product Specifications .....	Appendix B-2
--------------------------------	--------------

# Appendix B Product Specifications

---

## ■ Product Specifications

Model: built in the Konica 7020 series Printer/Copier  
(Konica 7020 / 7022 / 7025 / 7030 / 7130 / 7035)

Paper: You can select from the following paper sizes:

Paper Sizes to Be Selected	
A3	(297 x 420 mm)
A4	(210 x 297 mm)
A4R	(210 x 297 mm)
A5R	(148 x 210 mm)
B4	(257 x 364 mm)
B5	(182 x 257 mm)
B5R	(182 x 257 mm)
Ledger	(11 x 17 in)
Legal	(8.5 x 14 in)
Letter	(8.5 x 11 in)
LetterR	(8.5 x 11 in)
Statement	(5.5 x 8.5 in)
F4	(8.5 x 13 in)

Paper Feeding and Amount of Feeding Paper:

The same as the copier

Load Output Paper: The same as the copier

Mode: The dual operation of the Copier and the Printer is available.  
(5 jobs can be processed at the maximum.)

Special Printing: Duplex, Paper Type selection, Output Tray selection,  
Print Quality mode selection, Alternate, Staple function,  
Front/Back Cover function and Version display, etc.

Orientation: Portrait or Landscape.

Resolution: 600 dpi

Gradation: 1 bit

No. of Print: 1 to 999

Printable Area: Head Margin: 2.5 mm, Foot Margin: 4 mm and Right and Left Margins: 1 mm

Warm-up: the same as the copier

Basic Configuration

Control Board

CPU: PowerPC 401GF

Program Memory: FLASH ROM

System Memory: 16 MB SD-RAM (Standard),  
Expandable up to 80 MB (Option:MU-403/404)

Interface: Parallel port  
Centronics (IEEE 1284) / amphenol 36 pin male connector

Network Interface (Option):

KN304: Ethernet (100BaseTX / 10BaseT)  
Protocol: IPX/SPX (NetWare)  
LPD/LPR (TCP/IP)  
Peer-to-Peer (TCP/IP)  
IPP (Internet Printing Protocol)

Compliant OS: Windows 95/98/Me  
Windows NT4.0 (Service Pack 3 or later)  
Windows 2000  
Windows XP

Printer Language: Destiny WinStyler-Nozomi Version 2.0

Printer Driver: Printer Driver for Windows 95/98/Me  
Printer Driver for Windows NT  
Printer Driver for Windows 2000  
Printer Driver for Windows XP

Compliant Host Computer: A Windows-based computer

Compliant Finisher: FS-107 and IT-101

Compliant DB: DB-209/210 and DB-409/410

Dimension: 240 mm (W) \* 160 mm (H) \* 37 mm (D)  
9.44 inches (W) \* 6.3 inches (H) \* 1.46 inches (D)

Weight: Approx. 1.1 kg (2.43 pounds)

Power: AC 100V 50/60 Hz (maximum)  
(when using 16 MB SD-RAM and KN-304)

Working Environment:

Temperature: 5 degree °C to 55 degree °C  
41 degree °F to 131 degree °F

Humidity: 5 % to 95 %RH (non-condensing)

Restrictive Conditions

- In the Printer mode, the ECM (Electric Copy Monitor) of the Konica 7020 series is not available.
- Although the Weekly Timer function of the Konica 7020 series is available in the Printer mode, the power is not turned Off until the data output is finished when print data remains in the E-RDH.

Notice: Specifications are subject to change for improvements without notice.

# Index

Index ..... Index-2

# Index

## A

About ..... 3-8  
Add Port ..... 3-8  
Alternate ..... 3-8

## B

Back Cover ..... 3-9  
Basic Troubleshooting ..... Appendix A-3  
Booklet ..... 3-11  
Buttons of the Control Panel ..... 5-9

## C

[Color Management] tab ..... 3-4  
[Configuration] tab ..... 5-3  
Confirmation ..... 5-12  
Control Panel ..... 4-3, 5-3  
Control Panel are install ..... 5-4  
Copy Mode ..... 1-3

## D

Data Flow ..... 1-5  
DB-209/210 ..... 3-14  
DB-409/410 ..... 3-14  
Demo/Configuration Page ..... 4-10, 4-13  
[Details] tab ..... 3-4  
Display of the Status Monitor ..... 5-7  
Driver used for printing ..... 3-17

## E

E-RDH ..... 1-3  
End Capture ..... 3-12  
Error Message ..... Appendix A-2

## F

Factory Default ..... 4-10, 4-14  
Files to be Installed ..... 2-3  
Finisher ..... 3-12  
Finishing the Control Panel ..... 5-8  
Finishing the Status Monitor ..... 5-5  
Front Cover ..... 3-12  
Front/Back Cover-Paper Tray ..... 3-13  
Front/Back Cover-Paper Type ..... 3-13

## G

[General] tab ..... 3-4  
Group ..... 3-13

## H

Help ..... 4-10, 4-14  
How to Enter Settings on the LCD ..... 4-4  
How to Use Memory ..... 1-6

## I

I/O Interface ..... 1-4  
I/O Timeout ..... 4-10, 4-12  
Installation of the Printer Driver ..... 2-3  
IP-011 Hardware Configuration ..... 1-4  
IT-101 ..... 3-12

## L

Language ..... 4-9  
LCD ..... 4-3

## M

[Main Menu] ..... 4-6  
Memory Error ..... Appendix A-5  
Memory Overrun ..... Appendix A-5  
Memory Upgrading ..... 1-6

## N

Network Setup ..... 4-9, 4-11  
New Driver ..... 3-14  
NIC Configuration ..... 4-10, 4-13  
Numeric keys ..... 4-6

## O

[Option] tab ..... 2-24, 3-4  
Orientation ..... 3-15  
Overview of the Printer Controller ..... 1-3  
Output Tray ..... 3-15  
Overrun ..... Appendix A-5

**P**

Page Protection ..... 4-10, 4-12  
 Paper Type ..... 3-16  
 Paper-Original Paper ..... 3-17  
 Port settings ..... 3-16  
 Print Page Borders ..... 3-16  
 Print Quality ..... 3-16, 4-10, 4-12  
 [Print Quality] tab ..... 2-23, 3-4  
 Printer Driver Function List ..... 3-5  
 Printer Engine ..... 1-3  
 Printer Menu Screen ..... 4-5  
 Printer Mode ..... 1-3  
 Printer Setting screen ..... 4-6  
 [Printer Setting] tab ..... 5-3  
 Printing port ..... 3-16  
 Procedures of the Printer Setting ..... 4-7  
 Property of Printer Driver ..... 3-3

**R**

Reset ..... 4-3  
 Restarting the Status Monitor ..... 5-5

**S**

[SCANNER/PRINTER] button ..... 4-3  
 Select Language ..... 4-11  
 [Setup] tab ..... 2-20  
 [Sharing] tab ..... 3-4  
 Sharing ..... 3-18  
 Show/Hide the Status Monitor ..... 5-6  
 Sorting ..... 3-18  
 Staple ..... 3-19  
 Starting the Control Panel ..... 5-8  
 Starting the Status Monitor ..... 5-5  
 Status Monitor ..... 5-3  
 Status Monitor install ..... 5-4  
 Status Monitor working environment ..... 5-4  
 [STOP/CLEAR] button ..... 4-3

**T**

Test Print ..... 4-10, 4-13

[Test Print] tab ..... 5-3, 5-12  
 Timeout settings ..... 3-20

**U**

Uninstaller ..... 2-17

**W**

[Watermark] tab ..... 2-25, 3-4





Konica Business Technologies, Inc.  
500 Day Hill Road Windsor, CT 06095  
Telephone: (860)683-2222  
OP-IP011-04