

Swimming Pool Heat Pump
Eraspa
(THP05n~THP06n)

INSTALLATION AND USER MANUAL

Content

I.	Application	2
II.	Features	2
III.	Technical Parameters	3
IV.	Dimension	4
V.	Installation Guide	5
VI.	Controller Operation	8
VII.	Testing	10
VIII.	Precautions	11
IX.	Maintenance	12
X.	Troubleshooting	13

Thank your choosing our product and your trust in our company. To help you get maximum pleasure from using this product, please read this instruction manual carefully and operate strictly according to the user manual before starting the machine, otherwise the machine may be damaged or cause you unnecessary harm.

I. Application

- 1- Set swimming pool water temp efficiently and economically to provide you comfort and pleasure.
- 2- User may choose the model technical parameter according to professional guide, this series of swimming pool heater has been optimized in factory (refer to technical parameter table).

II. Features

- 1- High efficient titanium heat exchanger.
- 2- Sensitive and accurate temp control and water temp display.
- 3- R407c environment friendly refrigerant.
- 4- High pressure and low pressure protection.
- 5- Exceeding low temp auto stop protection.
- 6- Temp control compulsory defrosting.
- 7- International brand compressor.
- 8- Easy installation and operation.

III. Technical Parameter

Model		THP05n	THP06n
Function	Heating Capacity KW	4.5	5.5
	Rated Power/ Max Power KW	0.8/ 1.1	1.1/ 1.5
	C.O.P	≥6.0	≥6.0
	Power Supply	220-240V/1Ph/50Hz	
	Rated Current/ Max Current A	3.7/ 5.0	5.0/ 6.8
	Noise dB(A)	≤48	≤48
	Net Weight / Gross Weight kg	33/ 38	33/ 38
	Water pipe in-out spec mm	50	50
Adviced Water flux m³/h	3-4	3-4	

Notice:

1. This product can work well under air temp 0°C~+35°C, efficiency will not be guaranteed out of this range. Please take into consideration that the pool heater performance and parameters are different under various conditions.
2. Related parameters are subject to adjustment periodically for technical improvement without further notice. For details please refer to nameplate.

IV. Dimension

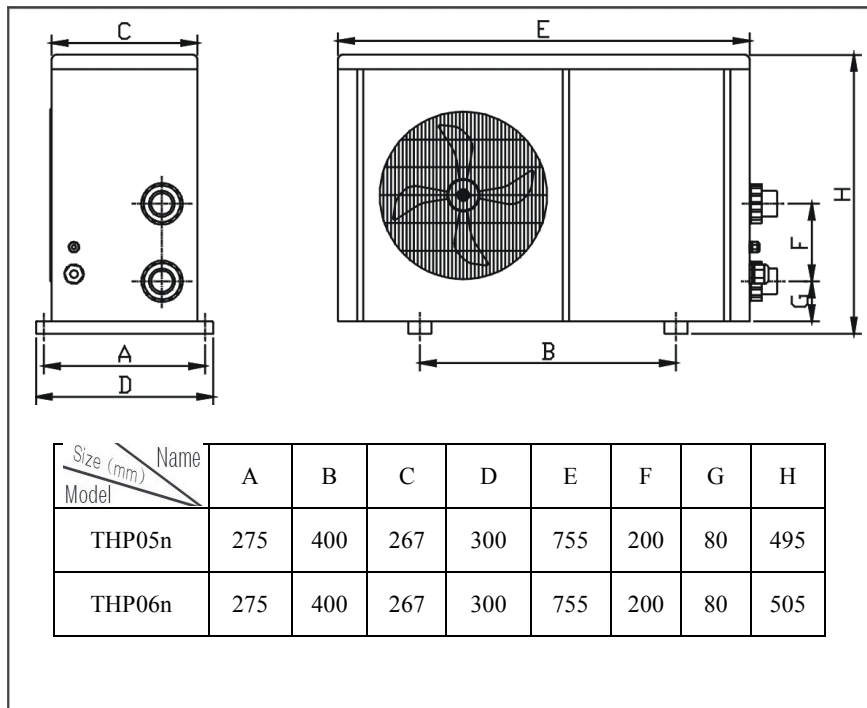

※ Above data is subject to modification without notice.

Note:

The picture above is the specification diagram of the pool heater, for technician's installation and layout reference only. The product is subject to adjustment periodically for improvement without further notice.

V. Installation instruction

1. **Drawing for water pipes connection** (Notice: The drawing is just for demonstration, and layout of the pipes is only for reference.) .

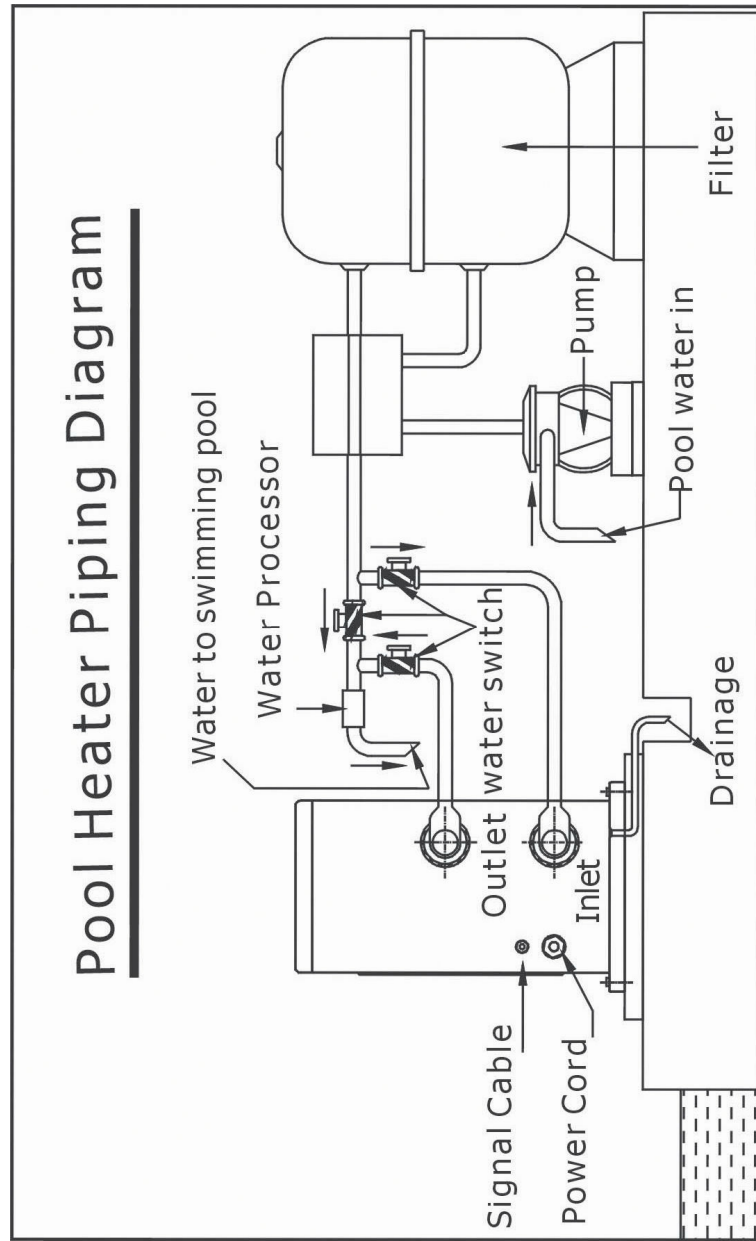

2. Electric Wiring Diagram

A. For power supply: 380~415V 50Hz or 60Hz

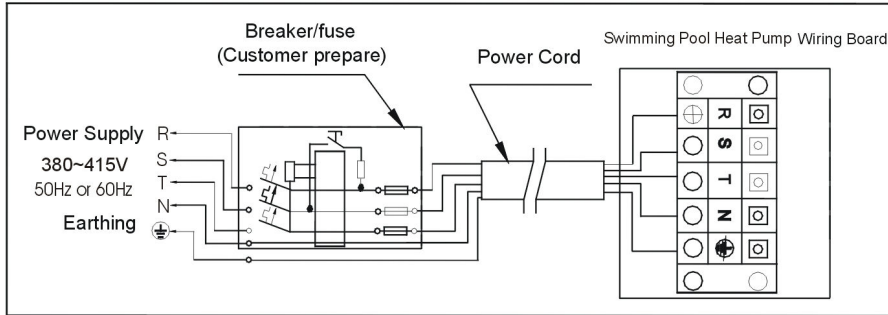

B. For power supply: 220~240V 50Hz or 60Hz

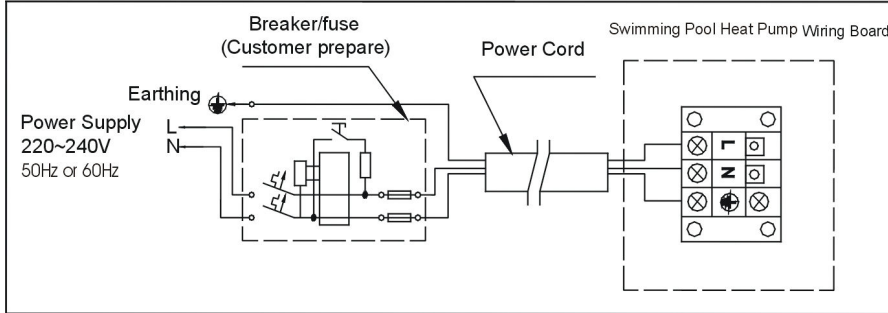

Note: The swimming pool heater must be earthed well.

Options for protecting devices and cable specification

MODEL		THP05n	THP06n
Breaker	Rated Current A	15	15
	Rated Residual Action Current mA	30	30
Fuse	A	15	15
Power Cord	(mm ²)	3×2.5	3×2.5
Signal cable	(mm ²)	3×0.5	3×0.5

※

Above data is subject to modification without notice.

Note: The above data is adapted to power cord ≤ 10 m .If power cord is ≥ 10 m, wire diameter must be increased. The signal cable can be extended to 50 m at most.

3. Installation instruction and requirement

The swimming pool heater must be installed by a professional team. The users are not qualified to install by themselves, otherwise damage may happen to the heater or threat the body safety of the user.

A. Installation

- 1) The swimming pool heater should be installed in a place with good ventilation;
- 2) The frame must be fixed by bolts (M10) to concrete foundation or brackets. The concrete foundation must be solid and fastened; the bracket must be strong enough antirust treated;
- 3) Please don't stack substances that will block air flow near inlet or outlet area, and there is no barrier within 50cm behind the main machine, or the efficiency of the heater will be reduced or even stopped;
- 4) The machine needs an appended pump (Supplied by the user). The recommended pump specification-flux: refer to Technical Parameter, Max. lift ≥ 10 m;
- 5) When the machine is running, there will be condensation water discharged from the bottom, please pay attention to it. Please hold the drainage nozzle (accessory) into the hole and clip it well, and then connect a pipe to drain the condensation water out.

B. Wiring

- 1) Connect to appropriate power supply, the voltage should comply with the rated voltage of the products.
- 2) Earth the machine well.
- 3) Wiring must be handled by a professional technician according to the circuit diagram.
- 4) Set leakage protector according to the local code for wiring (leakage operating current ≤ 30 mA).
- 5) The layout of power cable and signal cable should be orderly and not affecting each other.

C. Switch on after finishing all wiring construction and re-checking.

VI. Operation instruction



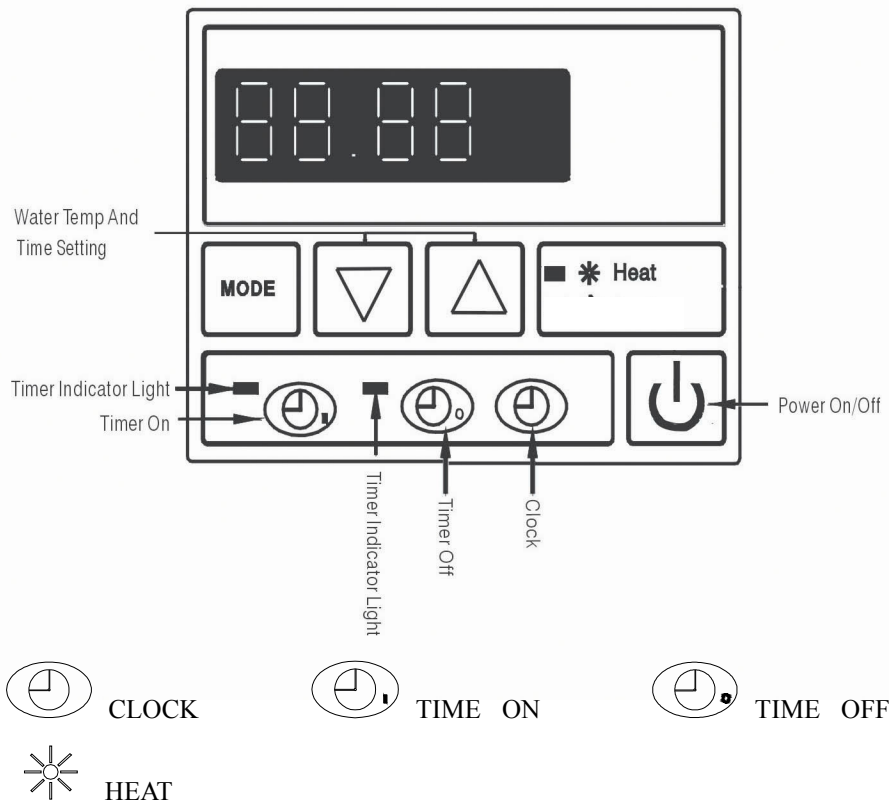

Picture for keys











1. Operation Display

- A. The display shows Time when the machine is off;
- B. The display shows Temperature of the swimming pool water when the machine is on.







2. Water temperature setting

- A. Available no matter the machine is on or off;
- B. Press the key  or  to set water temperature. The controller indicates twinkling temp. Press  or  to adjust to your required water temp;
- C. 5 seconds later, the controller display will back to the normal mode.









3. Time setting

- A. Available no matter the machine is on or off;
- B. Press  key to set time. When the clock on the screen is twinkling, press  again to set hour. Use  and  to adjust. Before the twinkling stops, press  to set minute Use  and  to adjust. After adjusting, press  and water temperature will be seen. 30 seconds later, the controller display will be back to the normal mode.



4. Timer on and off

- A. Press  to set timer on. When the indicator light is on and the time is twinkling, press  again to set hour. Use  and  to adjust. Before the twinkling stops, press  to set minute Use  and  to

adjust. After adjusting, press “TIMER ON” and water temperature will be seen. 30 seconds later, the controller display will be back to the normal mode;

- B. Press  to set timer off.. When the indicator light is on and the time is twinkling, press  again to set hour. Use  and  to adjust. Before the twinkling stop, press  to set minute Use  and  to adjust. After adjusting, press  and water temperature will be seen. 30 seconds later, the controller display will be back to the normal mode;

- C. Cancel timer on and off

Press  or  to cancel timer on and off. When the number is twinkling, press . When timer indicator light is off and LED shows water temperature, the timer on and off is canceled. 30 seconds later, the controller display will be back to the normal mode.

VII Testing

1 . Inspection before use

- A. Check installation of the whole machine and the pipe connections according to the pipe connecting drawing;
- B. Check the electric wiring according to the electric wiring diagram; and earthing connection;
- C. Make sure that the main machine power switch is off;
- D. Check the temperature setting;
- E. Check the air inlet and outlet.

2 . Trial

- A. The user must “Start the Pump before the Machine, And Turn off the Machine before the Pump”, or the machine will be damaged;
- B. The user should start the pump, check for any leakage of water; and then set suitable temperature in the thermostat, and then switch on power supply;
- C. In order to protect the swimming pool heater, the machine is equipped with a time lag starting function, when starting the machine, the blower will run 1 minutes earlier than the compressor;
- D. After the swimming pool heater starts up, check for any abnormal noise from the machine.

VIII. Precautions

1 . Attention

- A. Set proper temperature in order to get comfortable water temperature; to avoid overheating or overcooling;
- B. Please don't stack substances that can block air flow near inlet or outlet area, or the efficiency of the heater will be reduced or even stopped;
- C. Please don't put hands into outlet of the swimming pool heater, and don't remove the screen of the fan at any time;
- D. If there are abnormal conditions such as noise, smell, smoke and electrical leakage, please switch off the machine immediately and contact the local dealer. Don't try to repair it yourself;
- E. Don't use or stock combustible gas or liquid such as thinners, paint and fuel to avoid fire;
- F. In order to optimize the heating effect, please install heat preservation insulation on pipes between swimming pool and the heater. During running period of the swimming pool heater, please use a recommended cover on the swimming pool;
- G . Connecting pipes of the swimming pool and the heater should be $\leq 10\text{m}$, or the

- heating effect of the heater cannot be ensured;
- H. This series of machines can achieve high efficiency under air temperature of $+15^{\circ}\text{C} \sim +25^{\circ}\text{C}$.

2 . Safety

- A. Please keep the main power supply switch far away from the children;
- B. When a power cut happens during running, and later the power is restored, the heater will start up automatically. So please switch off the power supply when there is a power cut, and reset temp when power is restored;
- C. Please switch off the main power supply in lightning and storm weather to prevent from machine damage that caused by lightning;
- D. If the machine is stopped for a long time, please cut off the power supply and drain water clear of the machine by opening the tap of inlet pipe.

IX. Maintenance

- A. “Cut off” power supply of the heater before any examination and repair;
- B. In winter seasons, please drain water clear of the machine, “cut off” power supply to prevent any machine damage, and cover the machine body with plastic foil to avoid dust;
- C. Please clean this machine with household detergents or clean water, NEVER gasoline, thinners or any similar fuel;
- D. Check bolts, cables and connections regularly.

X. Trouble shooting for common faults

	Phenomenon	Reason
Not failure	A.Noticeable White vaporous cold air or wate B.Plopping sound	A.The fan motor stops automatically for defrost. B.Sound from the solenoid valve when starting and ending of defrost. C.During operation or just stop,sound like water flow,and largely in 2~3 minutes of starting the machine.This Sound comes from flowing refrigerant or dehumidification. D.The plopping sound during theo peration is caused by expand on heating and contract on cooling of the heat exchanger when temperature varies.
	Automatic start or stop	Check whether there is maloperation on the timer.
Recheck		A.Power supply failure B.Check manual power supply switch to make sure it is on. C.Fuse burned. D.If protector has started (operating light is on) E.Set timer on (the operating light is on)
	Running but not heating	Check if there is block on air inlet and outle t of the unit.

Note: If the following conditions happen, please stop the machine immediately, and turn off the manual power supply switch, then the contact local dealer.

- a) Inaccurate switch action;
- b) The fuse is frequently broken or leakage circuit breaker jumped.

Failure code

NO.	Failure code	Failure description
1	EE 1	High pressure protection
2	EE 2	Low pressure protection
3	EE 3	Low water pressure protection
4	EE 4	A.1 phase machine:failure connection due to loose wire terminal of PROT2 on the PC board; B.3 phase sequence protection .
5	PP 1	Swimming pool heat pump sensor failure
6	PP 2	Exhaust sensor failure
7	PP 3	Coil pipe sensor failure
8	PP 4	Intake pipe sensor failure
9	PP 5	Air temp sensor failure
10	PP 6	Compressor exhaust overload protection
11	PP 7	When the air temperature $< 0^{\circ}\text{C}$, auto stop protection (Not Failure)