

# **BAKER**

## **Products**



## ***Baker Model 18HD™***

### ***User Manual***

**Ellington Industrial Supply, Inc.**

P. O. Box 128

Ellington, Missouri 63638 USA

Web site: [www.baker-online.com](http://www.baker-online.com) E-mail: [info@baker-online.com](mailto:info@baker-online.com)

Phone: (573) 663 – 7711 Fax: (573) 663 – 2787



## TABLE OF CONTENTS

TAB	SECTION AND SUB-SECTION TITLE	PAGE #
1	INTRODUCTION	3
	Machine Purpose	3
	Machine Function	3
	Definition of Terms	4
	Manual Contents Notice	5
	Machine Specifications and Requirements	5
	Warranty	6
	Defective Parts	7
	Service Policy	7
2	RULES FOR SAFE OPERATION	8
	Safety Expectations for Operating Power Equipment	8
	Control of Hazardous Energy – (Lockout / Tagout)	9
	Machine Safety Decals	10
3	INSTALLATION	11
	Receiving and Inspection	11
	Unpacking	11
	Machine Moving	11
	Track and Machine Positioning	11
4	SET-UP AND OPERATION	12
	Operator Training	12
	Blade Tensioning	13
	Blade Tracking / Blade Tracking Adjustment	14
	Getting Started	15
	Making the Cut	15-17
5	USE OF LUMBER SCALE	18
	Calibrating Lumber Scale	19
6	SECURING THE MILL FOR TRANSPORT	20
7	MAINTENANCE	21
	General Clean-up	21
	Inspection and Preventative Maintenance	22-25
8	GUIDES	26
	Setting and Adjusting the Guides	26
9	PARTS AND SERVICE	27
	Parts Pictures and Description	27
	Service Contact Information	28
	Serial Number Location	28



## INTRODUCTION

*Thank you and congratulations* on the purchase of your new **Baker Model 18HD**. It has been designed to be durable, productive and easy to use. When properly used and maintained, it will provide you with many years of profitable operation.

For safety reasons, and for your own best use of the **Baker Model 18HD**, we must insist that you read this manual fully, and constantly review and refer back to it as necessary.

*No one should attempt to operate or perform maintenance on this equipment until they have been trained and taken the time to read and understand the information contained in this manual.*

## Machine Purpose

The **Baker Model 18HD** is the economical choice for turning timber into valuable boards and squares.



## Machine Function

The **Baker Model 18HD** utilizes a 15 horse power electric motor to turn the 18-inch band wheels that allow you to cut logs up to 30-inches in diameter and 16-feet or 20-feet, 6-inches in length. Utilizing Baker's exclusive roller style guide system, the thin-kerf blade easily pushes through the log. Blade height adjustment is easy and simple too.



## Definition of Terms

<b>Bark</b>	The outer-most protective layer of a tree composed of dead cork and other elements
<b>Band Saw</b>	A saw consisting of a continuous piece of flexible steel, with teeth on one side
<b>Board Foot or Board Feet</b>	A form of measurement where one board foot equals the volume of a board 1 inch thick by 12 inches wide and 12 inches long (1" x 12" x 12" = 1 board foot)
<b>Cant</b>	The 3 or 4 sided timber left over from a log, normally the center or core of the log
<b>Cant Hook</b>	A device used for rolling cants or logs
<b>Carriage</b>	A framework on wheels that allows movement of the saw back and forth past the log
<b>Edger</b>	A sawmill machine used to remove wany edges from flitches after they come off the sawmill, squaring the edges and ripping the flitch into lumber
<b>Fence (Arm)</b>	A straight guide used to keep a log, cant or board a set distance from a blade or cutter
<b>Flitch</b>	A longitudinal section of a log with wany edges
<b>Saw head or Head Saw</b>	The principle support structures on a sawmill that carries the engine, wheels and band blade used for the initial breakdown of a log
<b>Kerf</b>	The groove or thickness of the path cut by the saw teeth; the total amount of sawdust removed during a single cut
<b>Log Bunk</b>	A cross support that a log is loaded onto
<b>Lumber (board)</b>	A longitudinal section of a log after the wany edges have been removed, normally a 4-sided rectangular shaped piece
<b>Production Rate</b>	A produced or processed quantity measure with respect to another measured quantity of time; for example number of boards per minute, board feet per hour, per day, per week, etc.
<b>Slab</b>	The exterior portion of a log removed by the saw, having one flat and one rounded portion of a log
<b>Thin Kerf</b>	A relative term, typically referencing band saw blades which are usually thinner than circular saw blades thus resulting in greater lumber recovery, accuracy and smooth finish
<b>Wany</b>	Waning or diminished in some parts; not of uniform size throughout; sawed boards or timber that is tapered or uneven, from being cut too near the outside of the log bark
<b>Yield</b>	To generate a return for effort, an amount produced



## Manual Contents Notice

This manual is not totally comprehensive. It does not and cannot convey every possible safety and operational problem that may arise while using this machine. The manual will cover many of the basic and specific safety procedures needed in an industrial environment.

All federal and state laws and any regulations having jurisdiction covering the safety requirements for use of this machine take precedence over the statements in this manual. Users of this machine must adhere to such regulations.

## Machine Specifications and Requirements

**Power:** 18-HP gasoline engine with 12-volt battery and electric start

**Band Wheels:** 18-inch diameter

**Band Blade:** 13-feet, 5-inches long by 1-1/4 inch wide

**Blade Thickness:** 0.035-inch

**Blade Kerf:** 0.080-inch

**Guides:** Roller blade guide system for higher production, accuracy and extended blade life

**Track Length:** 26-feet

**Machine Width:** 74-inches

**Machine Height:** 53-inches (with trailer axle removed)

**Combined Weight:** Standard 26-foot track length and saw head approximately 1,500 pounds

**Production Rate:** Varies according to type of material, thickness of cut, and rate of speed material is cut.



## Warranty

Ellington Industrial Supply, Inc. machinery is warranted against defects in material or workmanship starting from the date of shipment from the manufacturing plant.

This warranty is given solely to the “original purchaser” of the equipment and is in no way to be expressed or implied that it is transferable to any other parties without the written consent and approval from the CEO or Sales Manager of Baker Products.

Our one (1) year warranty period covers all items built at our manufacturing facilities including structural frame, cowlings, doors, shafting, dust chutes, trailer axle and guards.

We honor six (6) months of warranty coverage for miscellaneous vendor-purchased-supplied items including bearings, chain, sprockets, hydraulic components, etc.

Ninety (90) days of warranty coverage is provided on all electrical parts. All electrical components and wiring has been installed in accordance with the National Electrical Code (NEC) of the United States of America.

Ellington Industrial Supply, Inc. does not warranty this machine to meet any other requirements or jurisdiction of any electrical or safety codes of any other state, municipality, other country or jurisdiction. The purchaser assumes all risk and liability whatsoever resulting from the use thereof whether used singularly or in conjunction with other machinery or apparatus, including, but not limited to, all matters resulting from sawdust generation.

**Note:** *No warranty is provided on any electrical components or parts if equipment is powered or connected to a roto-phase electrical converter in order to create a three phase power supply for operational current from a single phase source.*

Any change in materials, design, or performance intended to improve any product of Ellington Industrial Supply, Inc. shall not obligate Ellington Industrial Supply, Inc. to modify any previously manufactured equipment.

This manual may contain details that if not properly followed can affect the performance of your equipment. You are responsible for proper use and maintenance of your equipment and we reserve the right to deny warranty work if deemed to be caused by a lack of proper maintenance or negligence by the owner or any of their employees or other persons allowed to use the equipment.



## Defective Parts

Parts claimed defective must be returned freight prepaid, to our plant in Ellington, Missouri. Any part determined defective due to faulty workmanship or materials will be replaced or repaired (at our option) free of charge, F.O.B. our plant. This warranty does not cover expendable items (i.e. drive belts, band wheels, blades, cutters, guides, etc.). Except as expressly provided herein, this warranty is in lieu of all other warranties, expressed or implied, including a warranty of merchantability or fitness for a particular purpose. This warranty is "void" if any part of the unit has been tampered with, modified, altered, or operated with parts other than supplied or recommended by Ellington Industrial Supply, Inc. In no event shall Ellington Industrial Supply, Inc. be liable for special, indirect, incidental or consequential damages, however arising, including but not limited to, the loss of earnings or the cost of downtime.

## Service Policy

In the event that you have any problems, call us at (573) 663-7711 any time between 8:00 AM and 5:00 PM (CST), Monday through Friday. A member of our trained staff will answer any questions you may have. We charge nothing for this service.

The only charge is for replacement parts not covered by warranty or after our inspection we deem that the problem is due to operator error or lack of proper maintenance or neglect.

If it is necessary for a member of our service department to visit your plant at your request, there will be a charge for this service. Call our service department for current prices.

## Retain this Information for your Records

Model Number: .....  
Serial Number: .....  
Date of Purchase: .....  
Engine Make and Model: .....

### Ellington Industrial Supply, Inc.

P. O. Box 128





Ellington, Missouri 63638 USA

Web site: [www.baker-online.com](http://www.baker-online.com) E-mail: [info@baker-online.com](mailto:info@baker-online.com)

Phone: (573) 663 – 7711 Fax: (573) 663 – 2787

## RULES FOR SAFE OPERATION

The purpose of safety symbols and signage is to draw your attention to real or possible hazardous conditions that may exist when operating this equipment. Please remember that safety symbols and signage alone do not eliminate danger and are not substitute for proper training and education regarding operational hazards.

	<p>This symbol and warning indicates a potentially hazardous situation, which, if not avoided, <u>will</u> result in death or serious injury.</p>
	<p>This symbol and warning indicates a potentially hazardous situation, which, if not avoided, <u>could</u> result in death or serious injury.</p>
	<p>This symbol and warning indicates a potentially hazardous situation, which, if not avoided, <u>may</u> result in minor or moderate injury.</p>
	<p>This warning provides notice and instruction regarding a potentially hazardous situation, which, if not avoided <u>will</u> result in serious injury or death.</p>

## SAFETY EXPECTATIONS FOR OPERATING POWER EQUIPMENT

### ALWAYS...

- ENSURE THAT TRAINED PERSONNEL OPERATE, MAINTAIN AND REPAIR THIS EQUIPMENT
- TURN POWER OFF AND LOCKOUT / TAGOUT PRIOR TO PERFORMING MAINTENANCE
- KEEP WORK AREA CLEAN AND WELL LIGHTED TO MINIMIZE OR ELIMINATE HAZARDS
- KEEP CHILDREN AND VISITORS AWAY FROM OPERATING EQUIPMENT
- OPERATE THE EQUIPMENT AT THE RATE IT WAS DESIGNED FOR
- KEEP GUARDS IN PLACE WHEN OPERATING EQUIPMENT
- REMOVE TOOLS BEFORE RESUMING OPERATION
- USE PROPER EXTENSION CORD
- WEAR PROPER APPAREL AND AVOID CLOTHING AND ACCESSORIES THAT COULD GET CAUGHT IN MOVING PARTS
- ALWAYS WEAR SAFETY GLASSES AND HEARING PROTECTION
- AVOID "KICK-BACK" BY KNOWING WHAT CONDITIONS CAN CREATE IT
- CHECK DAMAGED PARTS AND REPAIR OR REPLACE THEM IMMEDIATELY

### NEVER...

- LEAVE TOOL RUNNING OR UNATTENDED, ALWAYS TURN POWER OFF
- OPERATE EQUIPMENT WHEN TIRED, FATIGUED OR UNDER THE INFLUENCE OF DRUGS OR ALCOHOL
- ALLOW UNTRAINED PERSONNEL TO OPERATE, MAINTAIN OR REPAIR THIS EQUIPMENT

**No list of safety expectations can ever be complete as every work environment is as different as the people operating it.**

**Always keep safety as your highest priority and always use this machine with caution and respect.**



## Control of Hazardous Energy – (Lockout / Tagout)

Lockout / Tagout (LOTO) refers to specific practices and procedures to safeguard employees from the unexpected energy, startup of machinery/equipment, or the release of hazardous energy during service or maintenance activities.

This requires that a designated individual turn off and disconnect the machinery/equipment from its energy source(s) before performing service or maintenance and that the authorized employee(s) lock and tag the energy-isolating device(s) to prevent the release of hazardous energy and take steps to verify that the energy has been isolated effectively.

### List of Related Terms

<b>Affected Employee</b>	An employee whose job requires them to operate a machine or piece of equipment on which service or maintenance is being performed.
<b>Authorized Employee</b>	A person who locks or implements a tagout system procedure on machines or equipment to perform the service or maintenance on that machine or equipment. An authorized employee and an affected employee may be the same person when the affected employee's duties also include performing service or maintenance.
<b>Energy Source</b>	Any source of electrical, mechanical, hydraulic, pneumatic, chemical, thermal, or other energy.
<b>Lockout</b>	The placement of a lockout device (such as a lock) on an energy-isolating device, in accordance with an established procedure that ensures the device and the equipment cannot be operated until the lockout device is removed.
<b>Servicing and / or Maintenance</b>	Workplace activities such as constructing, installing, setting up, adjusting, inspecting, modifying, and maintaining and/or servicing machines or equipment. These activities include lubrication, cleaning or un-jamming of machines or equipment, and making adjustments or tool changes where the employee may be exposed to the unexpected energy, start-up of equipment or release of hazardous energy.
<b>Tagout</b>	The placement of a tagout device (such as a tag) on an energy-isolating device, in accordance with an established procedure that ensures the device and the equipment may not be operated until the tagout device is removed.

**Example of lockout tags, lockout hasp and keyed lock**



### The Fatal Five Main Causes of Lockout/Tagout Injuries

1. ***Failure to stop equipment***
2. ***Failure to disconnect from a power source***
3. ***Failure to dissipate (bleed, neutralize) residual energy***
4. ***Accidental re-starting of equipment***
5. ***Failure to clear work areas before re-starting***

Machine Safety Decals \*\* Adhere to ALL Safety Warnings! \*\*

## Safety First

- ☞ Always allow all moving parts to stop completely before changing blade or servicing machine.
- ☞ Never operate machine without guards and doors in place.
- ☞ Always wear eye and ear protection when operating machine.
- ☞ Never wear loose clothing when operating this machine.
- ☞ Always keep fingers and hands away from blade while operating machine.

**CAUTION**  
**HOT**

**Do Not Operate  
Without Guards**

**BAKER**  
Products

## INSTALLATION

### Receiving and Inspection

- Upon receipt and prior to signing carrier's documents, conduct a walk-around and visual inspection of your new equipment. **Note any damage in writing upon the carrier's bill of lading and contact Baker Products immediately. Failure to do so could reverse damage charges back to receiving party.**

**Note:** All new equipment is assembled and thoroughly tested prior to shipment, however damage may occur during transit, which could cause the machine to not operate correctly during start-up.

### Unpacking

- If machine was delivered via flatbed trailer, remove straps or chains securing it in place.
- If machine was delivered by crate, carefully remove upper crating materials from the base skid.
- Remove lag screws, strapping, etc. that attaches the machine to the skid.

### Machine Moving

- If required, lift machine at the indicated lift points only.
  - o Use a safety strap to avoid tip-over.
- Otherwise use the trailer / tow hitch provided.
- Transport machine to the operation site.

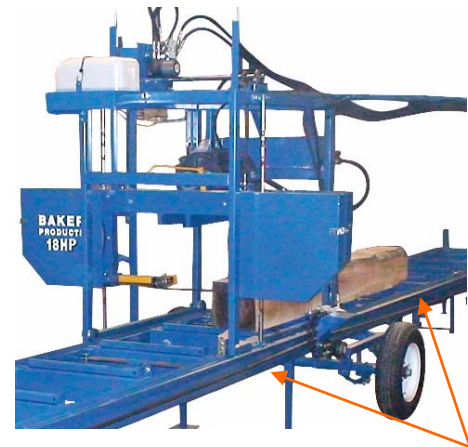

Lift points – center the saw head over the axle and equally space forks under the carriage frame for a balanced lift

### Track and Machine Positioning (*Placement, Leveling, Alignment*)

- For best performance, choose a solid and level foundation that is covered and dry, free of environmental elements such as rain or snow that could cause electrical or slip hazards.
- A level cement or concrete pad works best, but square timbers also work well
- Provide a minimum of 4 feet of clear workspace around the entire perimeter of the track.
- Remove trailer axle and store in a dry location.
- Assemble the track so that the log clamps are on the same side of the mill that the operator will work from.
- Bolt the sections of track together with the nuts and bolts provided, ensuring the track is flush where the ends are bolted together.
- Level the track front to back and side to side. For optimal results, the Model 18HD must be level and free of crowns or dips for the length of the adjoined tracks. Consider the use of a string line to check for straightness along the track length.
- The saw head raise/lower and carriage forward/reverse chain tension should be “taut” with no more than 1/2-inch of deflection.
- Raise the head a minimum of 3 inches and roll from end to end to verify the track is aligned properly for smooth operation. Adjust or re-level as necessary.



## SET-UP AND OPERATION

### Operator Training

According to many OSHA, ANSI, STATE, and LOCAL CODES, it is the EMPLOYER'S RESPONSIBILITY to:

- Permit only trained and authorized employees to operate and maintain equipment.
- Inspect and maintain guards, safety devices and start/stop controls.
- Instruct, train and supervise the safe method of work.

Be sure personnel are properly trained and safety rules are clearly understood before operating or performing maintenance.

- ✓ **Operator**
- ✓ **Machine**
- ✓ **Guards**
- ✓ **Devices**
- ✓ **Instructions**

*All of these together make up the safety system.  
Failure of any one of these factors will increase  
accident potential.*

**Note:** *Prior to start-up and then again after two weeks, check that all nuts and bolts are tight. Then follow the instruction and schedule outlined in the Inspection and Preventative Maintenance section.*

**FREE TRAINING ON PROPER SET-UP AND  
OPERATION IS AVAILABLE ON SITE AT  
THE MANUFACTURER'S FACILITY**

## Blade Tensioning

- ❑ Your mill is shipped to you with minimal blade tension to help avoid the development of flat spots that could cause the blade to track improperly on the band wheels.

**⚠ DANGER**

**Note: For the Honda 20-hp motor this requires the key to be removed from the ignition and a “do not operate” tag attached to the motor.**

- ❑ Open and remove the two (2) cowling doors.
- ❑ Verify that the back of the blade is flush with the back of each band wheel (**Figure 13**).
- ❑ To tension the blade, turn the t-handled all-thread bolt clockwise until the factory set tension marks align (**Figure 13A, 13C**).
- ❑ Carefully rotate the band wheel counter clockwise to ensure blade tracks properly.
  - See next section (**Blade Tracking**) if an adjustment is necessary.
- ❑ Once proper tension and tracking is achieved, return and secure the cowling doors.
- ❑ If necessary, refer to **Setting and Adjusting the Roller Guides**, page 25.

Back of band blade should be flush with back of band wheels



Figure 13

De-tensioned blade, marks not aligned

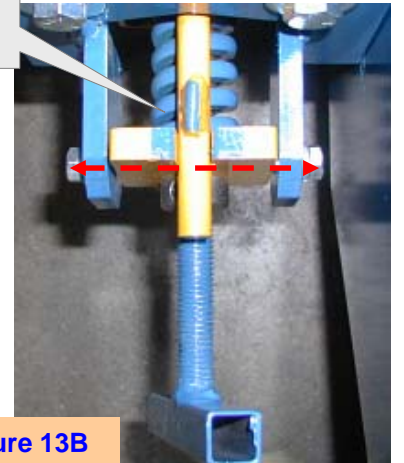

Figure 13B

Blade tension adjusting t-handle

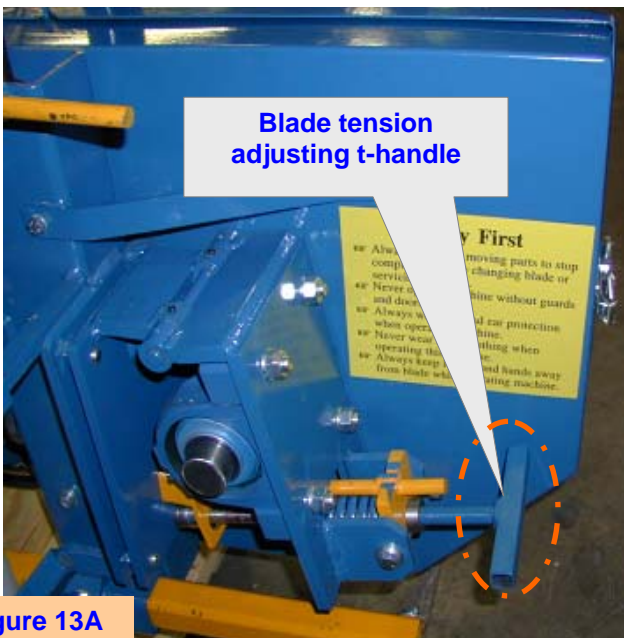

Figure 13A

Pre-set factory blade tension mark  
Marking aligned = proper tension

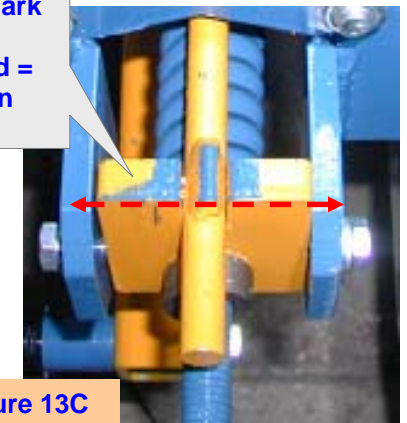

Figure 13C

## Blade Tracking

- ❑ The blade tracking is set at the factory prior to shipment, but it may periodically have to be adjusted or reset. Most band blades will vary on how they track due to blade material.



**Note: For the Honda 20-hp motor this requires the key to be removed from the ignition and a “do not operate” tag attached to the motor.**

## Blade Tracking Adjustment

**Note:** If the blade is tracking out just a little after running for a few minutes, don't be alarmed; most blades do this as they self-adjust to the contour of the wheels.

- ❑ Open and remove the two (2) cowling doors.
- ❑ If the blade is running out or in more than 1/32” you should try three or more blades or another box of blades before making any tracking adjustments. This will help you determine whether it's the blade(s) or something else that is affecting tracking.
- ❑ If the blade is **tracking outward** and you want to move blade tracking “inward”, adjust the top and bottom band wheel tracking bolts by loosening the center jamb nut and then tighten the bolts via the bolt head one (1) revolution to the right (**Figure 14 and 14A**).
- ❑ Next make the same adjustments on the opposite wheel by loosening the center jamb nut and then tighten the bolts via the bolt head one (1) revolution to the right.
- ❑ After tracking bolts have been adjusted, rotate the idler wheel several rotations counter-clockwise and look at the blade gullet in relation to the front face of the wheel to ensure tracking is consistent. Continue to adjust and fine tune as necessary.
- ❑ If the blade is **tracking inward** and you want to move blade tracking “outward”, loosen the center jamb nut and then loosen the tracking adjustment bolts one (1) revolution via the bolt head. Repeat the same steps for the opposite side wheel.
- ❑ Once proper blade tracking has been achieved, re-tighten the jamb nuts (2 per side) for both the pull and idler wheel.
- ❑ Return and fasten the cowling doors.

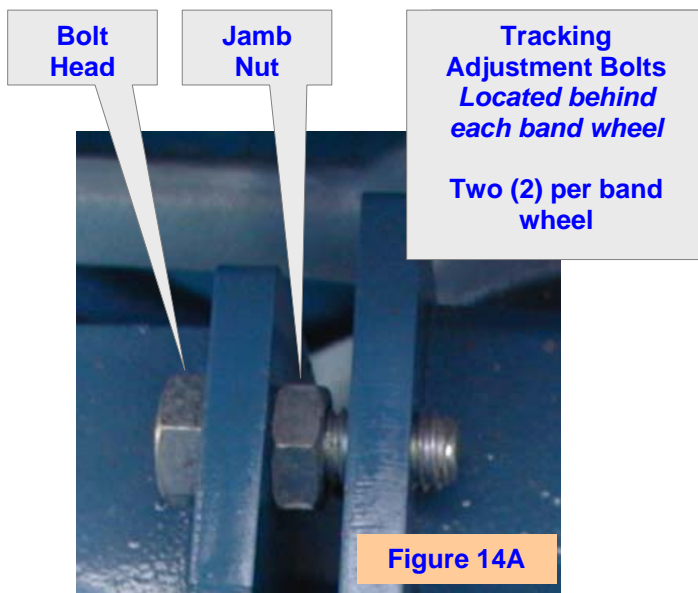

## Getting Started

Log loading options for this mill include the use of heavy-duty log ramps, manual or electric winch or the use of a forklift or front-end loader. After loading a log onto the track, roll it against the raised fence arms and secure it into position with the log clamp by turning the handle clockwise and screwing the clamp into the log.

**⚠ DANGER** **Note: Ensure top of fence arms and log clamp are positioned safely below the height of the blade. Failure to do so will result in blade damage.**



Figure 15



Figure 15A

Raised fence  
arms

## Making the Cut

### To START Processing

**Step 1:** Prior to starting the engine, complete a visual inspection to ensure all guards and covers are in place and secure.

**Step 2:** Loosen the t-handle securing the moveable guide and slide it in or out until it is slightly (*no more than 2 inches*) wider than the maximum width of the log. Tighten the t-handle after proper adjustment has been made (**Figure 15B & 15C**).

**Note:** As you cut slabs and boards or squares from your log, you will want to bring your guides in closer to ensure the best performance and quality cuts.

Backside view of t-handle  
securing moveable guide

Guides properly  
positioned for quality cut

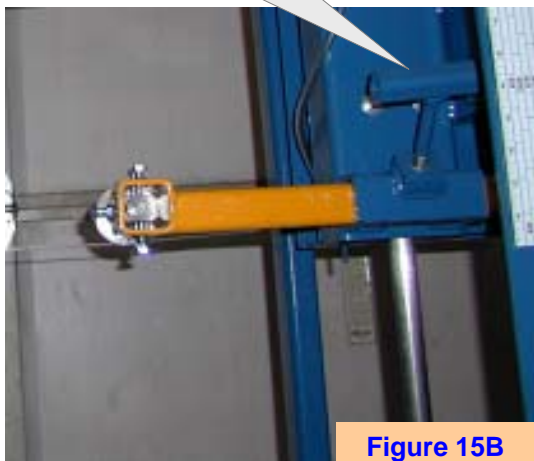

Figure 15B

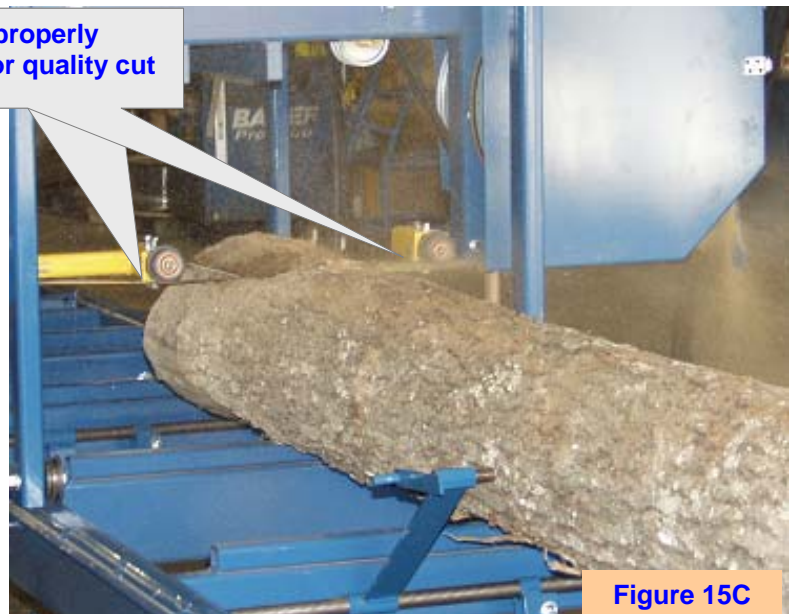
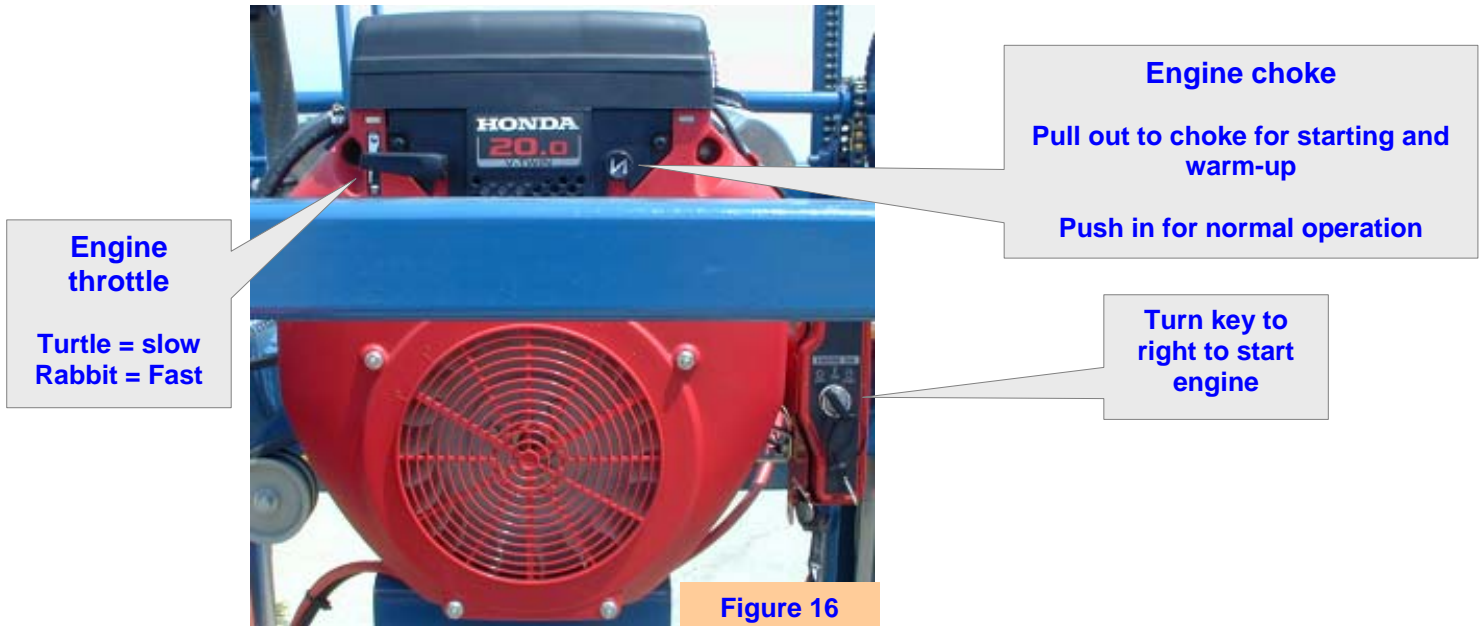

Figure 15C

## Making the Cut *(continued)*

**Step 3:** Start the engine and let it idle and warm up for at least 2 minutes. Maximize engine throttle when ready to cut.



**Step 4:** Engage drive belt by pulling down on belt tension arm handle (**Figure 16A**).



**Step 5:** Adjust blade height so you will only remove the top portion of the log (flitch).

**Note:** Typically you want to remove enough of a slab to open up a 4-inch face on the log. Therefore on the next cut you will produce at least a 4-inch wide flitch to be edged into a 4" wide board. This is a recommendation only. Depth and width of cut is subject to your desired finished product dimensions.



## Making the Cut *(continued)*

- Step 6:** Place your left hand on the center carriage cross-member and your right hand on the push/pull handle (**Figure 17**) and move the head forward in the direction of the back of the log. Allow the carriage to move forward and the blade to begin making its cut. Listen to the motor and if it begins to “bog-down” slow your advancement into and through the log.
- Step 7:** Once you’ve completed your cut, remove the slab and raise the saw head enough to clear the log and return the head carriage to the front of the log to make your next cut.
- Step 8:** Adjust saw head height to desired board thickness, then make cut and remove flitch.
- Step 9:** Raise the saw head and return carriage to the front of the log and idle the motor.
- Step 10:** Release the log clamps and use a cant hook to turn the log 1/4 turn to the right so the flat edge is against the fence arms. Ensure the fence arms and log clamps are well below the height of the passing blade before tightening.
- Step 11:** Repeat **Step 6** through **Step 10** until you’ve cut your log into the desired lumber sizes.



Place left hand on center carriage cross-member to move carriage forward and backward

Place right hand on push/pull handle

Figure 17

## To STOP Processing

- Step 1:** Disengage the belt drive by moving the tensioning handle upward, relieving pressure from the belt (**Figure 16A** on page 16).
- Step 2:** Reduce engine throttle to a minimum idling state, then turn the key to the off position.
- Note:** The band blade does not stop spinning automatically and will coast to a stop.
- Note:** Consider de-tensioning the blade if your machine is going to sit idle for a 24-hour period or longer.

## USE OF LUMBER SCALE

Your Baker Model 18HD is equipped with a lumber scale, which simplifies the lumber dimensioning process. The scale incorporates four separate scales with blade kerf factored-in for each increment. Our 1-1/4" x 0.035" Lennox blades have 0.080-inch kerf.

SCALE	RESULTING THICKNESS
4/4	1" thick boards
4/4 HWD ( <i>hardwood</i> )	1-1/8" thick boards
6/4	1-1/2" thick boards
8/4	2" thick boards

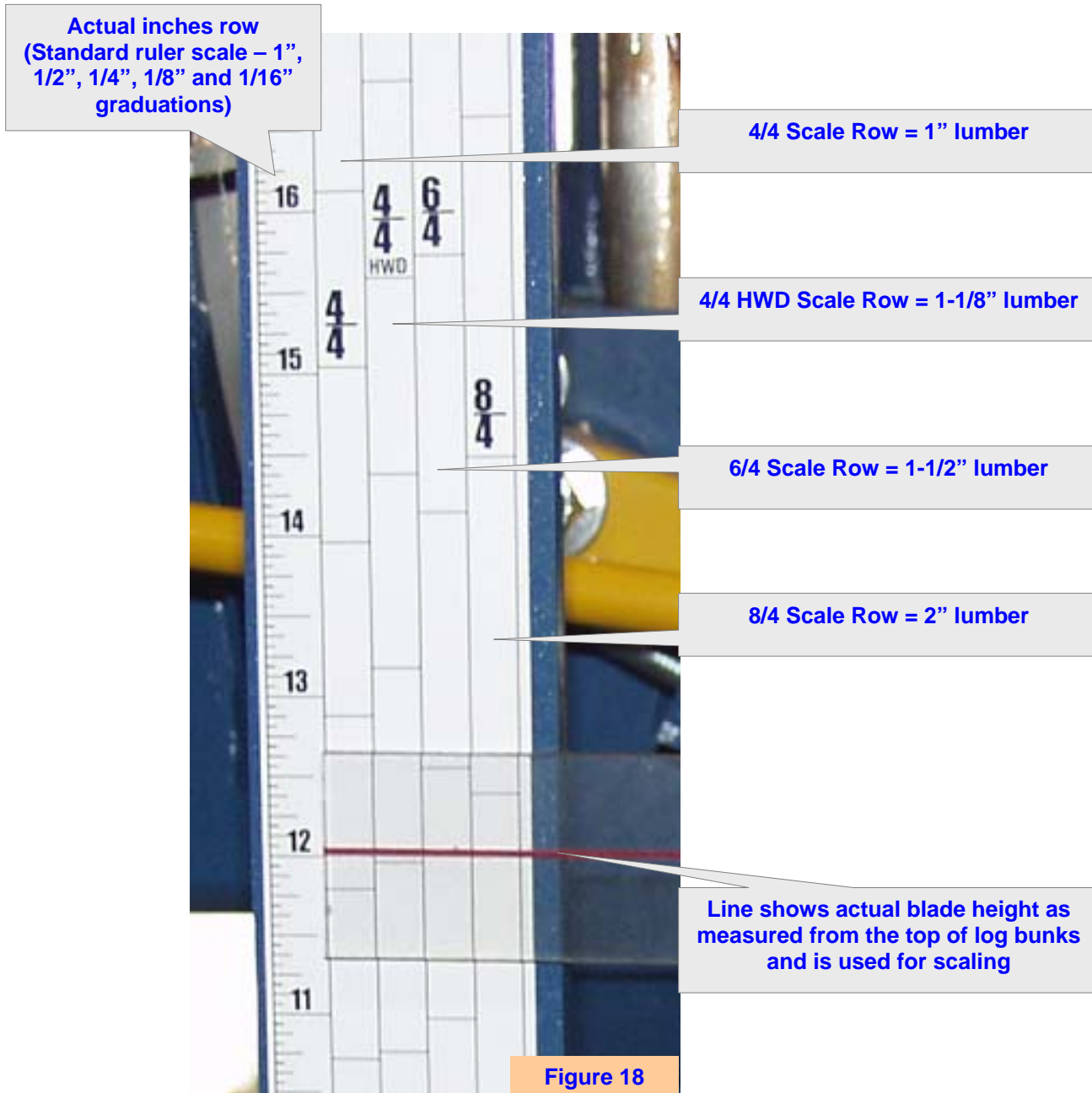
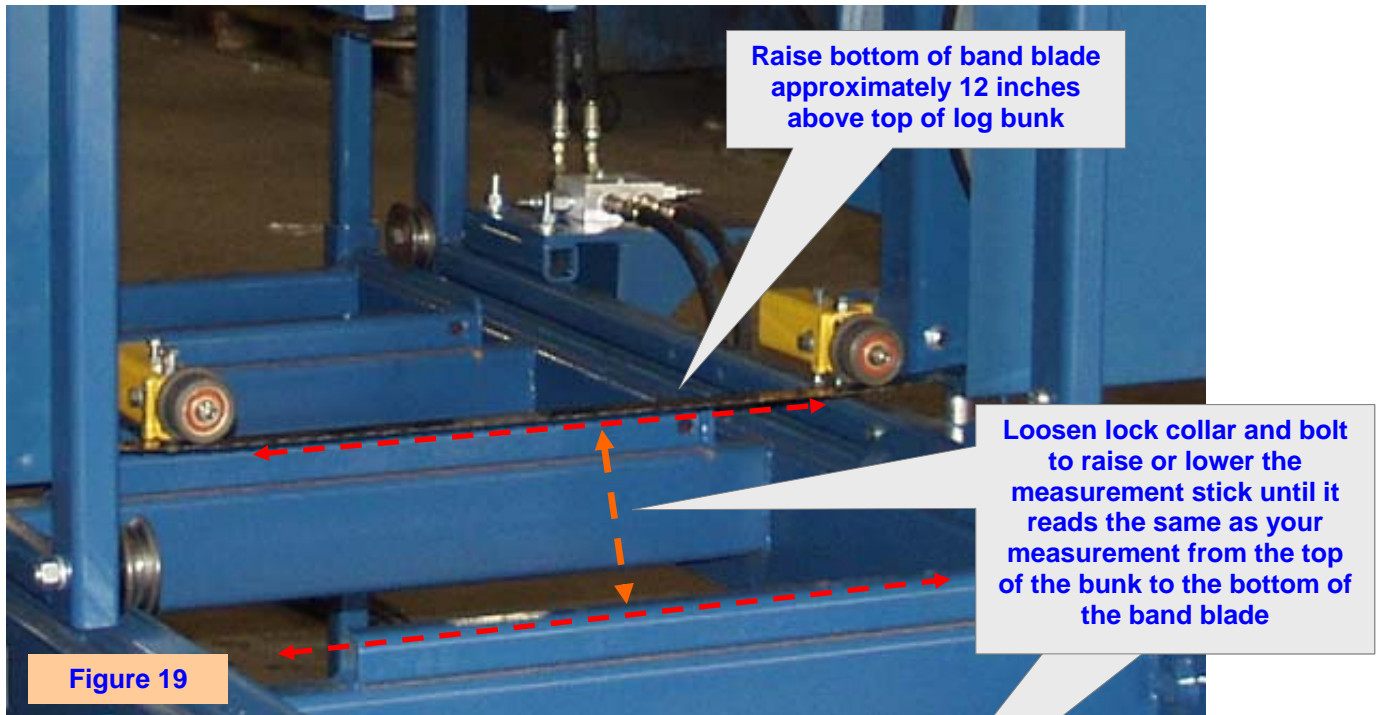

Figure 18

## Calibrating Lumber Scale

- ❑ To calibrate the lumber scale actual inches row, raise the band blade approximately 12 inches above the log bunks.
- ❑ Position the band blade over one of the center log bunks and take a measurement from the top of the log bunk to the bottom tooth of the blade.



- ❑ Loosen the screw holding the collar on the measurement stick and then loosen the bolt holding the measurement stick in place.
- ❑ Raise or lower the measurement stick until the red line/mark reads the same as the measurement you took from the top of the log bunk to the bottom tooth of the band blade.
- ❑ Once the two measurements match one another, tighten the bolt holding the measurement stick in place, and then tighten the screw holding the collar around the measurement stick so that it cannot slide downward during use.
- ❑ To verify, saw a timber into a 4-sided square and measure the actual size of the timber in correlation to the actual inches on the lumber scale. For example a 12-inch x 12-inch square.

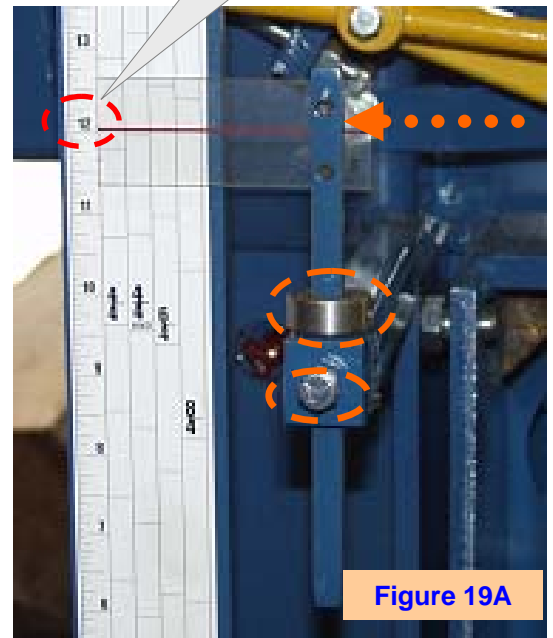

## SECURING THE MILL FOR TRANSPORT

- The mill requires a 2" trailer hitch ball on the tow vehicle to properly fit the trailer coupler.
- Ensure tires are properly inflated to the correct pressure, as stated on the sidewall.
- Position carriage over the axel and secured in place by aligning the holes of the hinged frame bracket to those on the carriage head frame and inserting two (2) bolts through the aligned holes. Tighten firmly with lock washers and nuts (**Figure 20**).
- Ensure the additional section of track fits squarely on the main frame is secured in place via the front leveling legs per the illustration below (**Figure 20A**).
- Ensure all fences and clamp arms are raised and secured in place.
- Ensure trailer hitch is properly fastened with cotter pin in place on the hitch latch and the two safety chains and brake activation pull cable are securely fastened to the tow vehicle.
- Rotate trailer jack to the horizontal position and secure in place with the locking pin.
- Verify that the brake lights and turn signals work properly prior to towing.

**NOTE:** Baker Products will not be held responsible for any injury or damage resulting from failure to follow all safety precautions associated with vehicle towing. It is the customer's responsibility to ensure that the mill meets all laws associated with towed equipment in their respective state or local. Insurance coverage is not provided by the manufacturer, but should be covered by the tow vehicle being used for transport.



## MAINTENANCE General Clean Up



*Follow proper Lockout / Tagout procedures prior to performing any maintenance or repair on the machine.*

- On a daily basis, use an air-hose to blow-off the dust and wood chips that accumulate in and around the machine. If air is not available a soft brush will work as well.
- Machine operator is closer to operating mechanism of the machine during maintenance clean up more than during production – extra care should be taken.
- During daily clean up and daily maintenance of the machinery it is advised that the operator complete a visual inspection of the equipment to look for anything that may have been damaged or become loose during normal use.
- DO NOT clean with flammable or combustible materials.
- Follow applicable codes and standards with regards to:
  - Ventilation and monitoring of work area for excessive accumulation of hazardous vapors
  - Wearing personal protective equipment for handling materials
  - Using proper procedure for disposing of all waste materials

## Inspection and Preventative Maintenance



*Follow proper Lockout / Tagout procedures prior to performing any maintenance or repair on the machine.*

**Note: For the Honda 20-hp motor this requires the key to be removed from the ignition and a “do not operate” tag attached to the motor.**

Frequency	Recommendation
Daily	<input type="checkbox"/> Use an air-hose or soft brush to remove wood chips that accumulate in and around the machine and along the track.
Daily	<input type="checkbox"/> Check engine fuel and blade lubricant level by inspecting the fluid level on the side of the respective tanks.
Daily	<input type="checkbox"/> Clean the crown on the idler and pull wheels by using an air hose, brush or by wiping them down with a rag or shop towel, freeing them of dust and debris.
Daily	<input type="checkbox"/> Grease the roller guides. We recommend <b>JT-6</b> grease ( <b>no more than 3 pumps</b> ).
Daily	<input type="checkbox"/> Clean & inspect the blade guides. Excessively worn guides should be replaced.
Daily	<input type="checkbox"/> Check band blade rotation to ensure it is tracking properly.
Weekly	<input type="checkbox"/> Check idler and pull wheel bearings for wear. Signs of wear include excessive heat, squeaking sound or looseness.
Weekly	<input type="checkbox"/> Grease the idler and pull wheel bearings. We recommend <b>JT-6</b> grease ( <b>no more than 5 pumps</b> ).
Weekly	<input type="checkbox"/> Grease the raise / lower shaft bearings. We recommend <b>JT-6</b> grease ( <b>no more than 5 pumps</b> ).
Monthly	<input type="checkbox"/> Check drive belts for wear and ensure belt tension is “taut” with no more than 1/2” deflection when engaged.

**\*\* RETURN ALL GUARDS AND COVERS PRIOR TO RESUMING OPERATION! \*\***

## Inspection and Preventative Maintenance *(continued)*

### Daily

- ❑ Check engine fuel and blade lubricant level by inspecting the fluid level on the side of the respective tanks.



Engine  
gas tank

Figure 23

Keep a  
minimum  
of 1/2 full



Figure 23A

- ❑ Grease the roller guides. We recommend **JT-6** grease (*no more than 3 pumps*).

Grease  
Fitting

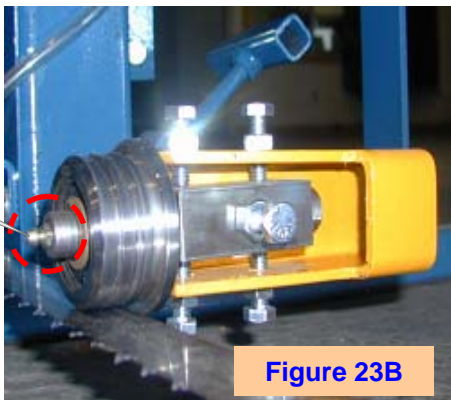
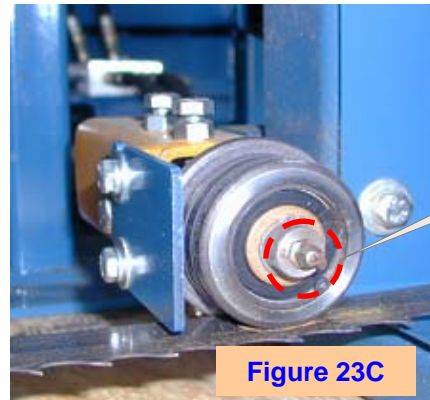

Figure 23B



Grease  
Fitting

Figure 23C

## Inspection and Preventative Maintenance *(continued)*

### Weekly

- ❑ Check idler and pull wheel bearings for wear. Signs of wear include excessive heat, squeaking sound or looseness.
- ❑ Grease the idler and pull wheel bearings. We recommend **JT-6** grease (*no more than 5 pumps*).

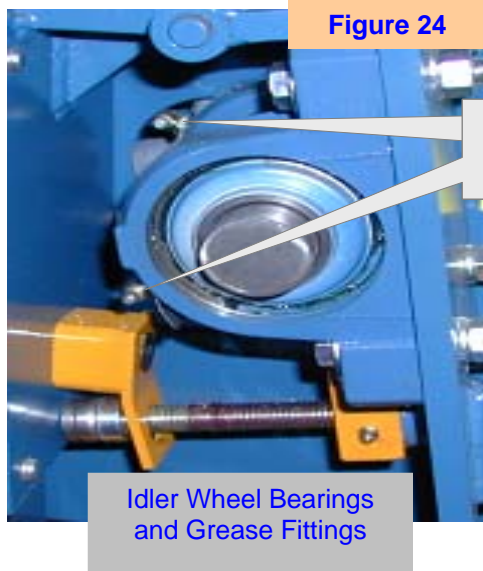

### Weekly

- ❑ Grease the raise / lower shaft bearings. We recommend **JT-6** grease (*no more than 5 pumps*).

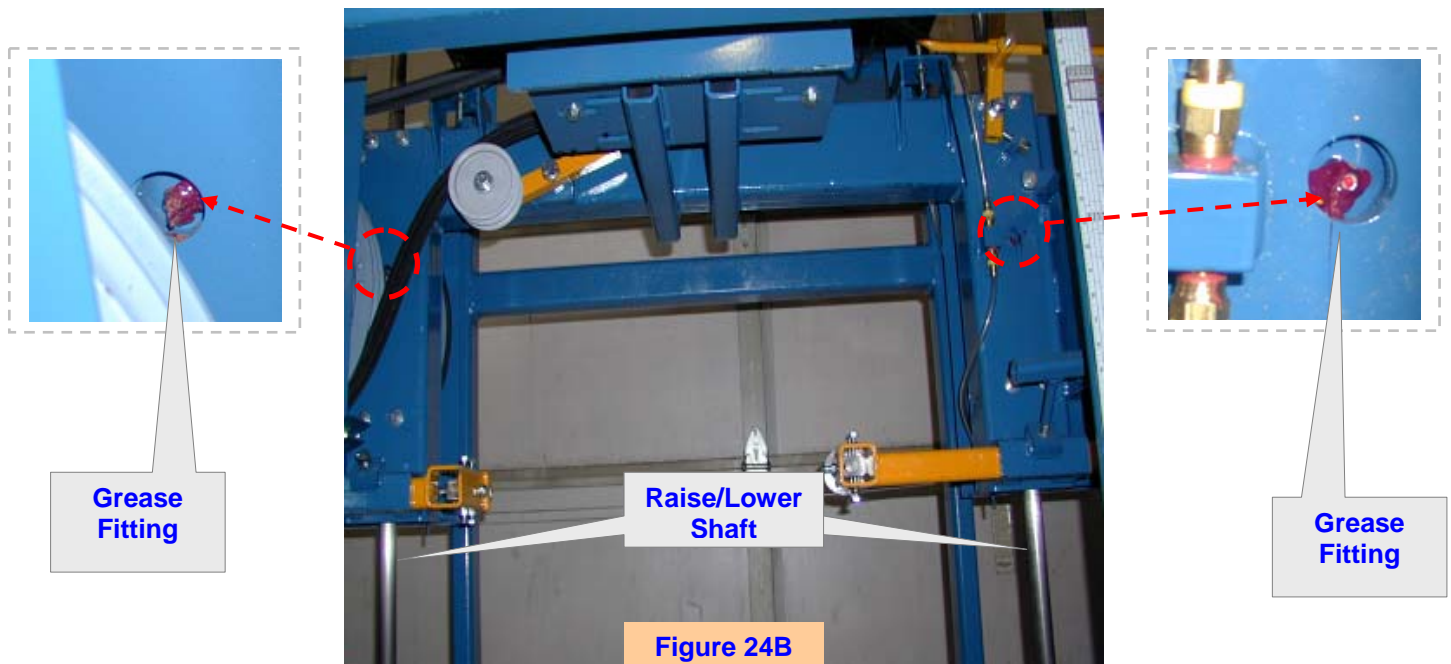



## Inspection and Preventative Maintenance *(continued)*

### Monthly

- ❑ Check drive belts for wear and ensure belt tension is “taut” with no more than 1/2” deflection when engaged.

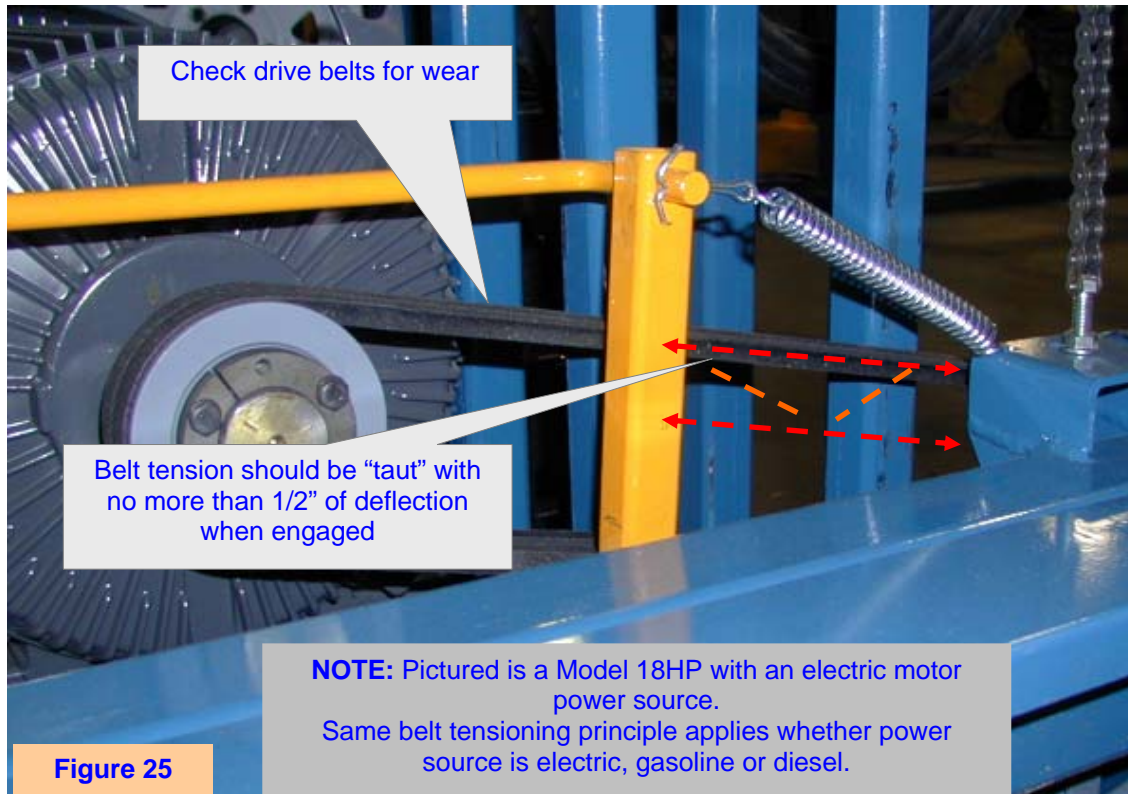

**NOTE:** If belts are slipping during start-up that may be a sign of loose belts.

### **SAFETY REMINDER**

**\*\* RETURN ALL GUARDS AND COVERS PRIOR TO RESUMING OPERATION! \*\***

## GUIDES

### Setting and Adjusting the Roller Guides

When properly set and utilized, your band blade guides will provide better blade control and longer blade life.

- To adjust or re-align the left/moveable roller guide, loosen the t-handle holding the guide arm in place. *(If adjusting the stationary right side guide, proceed to the next step).*
- Loosen the bolts **(A)** holding the roller guide in its vertical and horizontal position. These bolts serve as a roller guide tilting and/or leveling function.
- Loosen the bolts **(B)** that hold the roller guide edge against the back of the blade.
- Set the roller guides by ensuring the back edge of the guide is spaced 1/8-inch behind the back of the blade. Re-tighten the bolts **(B)** after adjustment and alignment is complete.
- The roller guide should rest evenly on the blade with no down force pressure applied. If a tilt adjustment is required and you haven't already done so, loosen the top and bottom tilting bolts **(A)** and adjust accordingly until you are satisfied the roller guides are level and even with the horizontal blade surface, then re-tighten the jamb nuts.
- Adjust the left/moveable guide to the required cutting width for your material and tighten the t-handle. Doing so will apply a small amount of down pressure on the blade.
- Ensure any remaining bolts, nuts and jam nuts associated with the left and right roller guide assemblies, including the guide arms are tight prior to resuming operations.

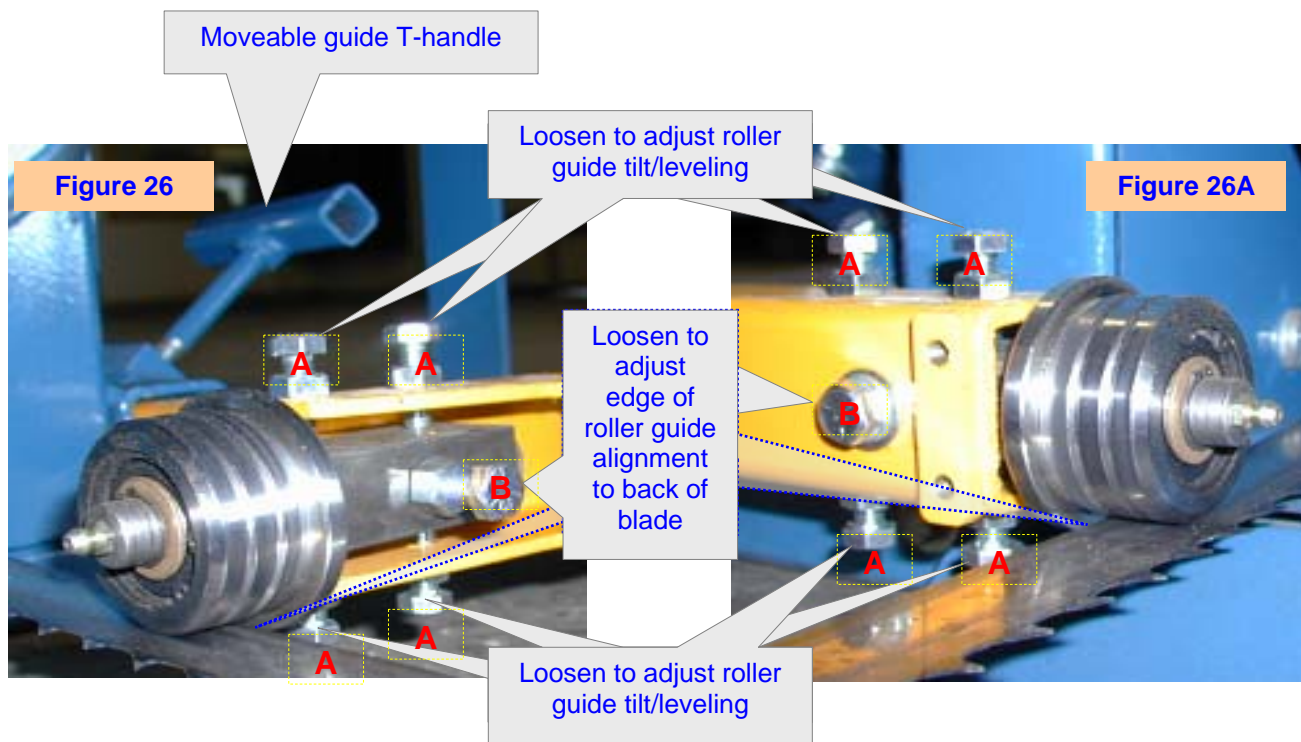

Left side – moveable guide assembly

Right side – stationary guide assembly

## PARTS AND SERVICE

Part Picture	Description	Part Picture	Description
111135 	B-56 BELT	111112 	B-90 BELT
133406 	40A45 x 3/4" SPROCKET	133408 	40B9 x 5/8" SPROCKET
133409 	40B10 x 3/4" SPROCKET	131025 	40B12F x 1" SPROCKET
131042 	50BB13H x 1/2" IDLER SPROCKET	133410 	40A15 x 5/8" SPROCKET
101380 	1 - 7/16" 2 BOLT FLANGE BEARING	101384 	603 - 1/4V THRUST BEARING
101120 	1" PILLOW BLOCK BEARING	101014 	1" 2 BOLT FLANGE 17/32" BOLT HOLE BEARING
121185 	#50 CHAIN ROLLER	121007 	#50 CHAIN CONNECTOR LINK
121003 	#40 CHAIN ROLLER	121004 	#40 CHAIN CONNECTOR LINK
664903 	CARRIAGE V WHEEL	141449 	RIGHT or LEFT GUIDE ASSEMBLY
271190 	OSD-362D x 1" TORQUE LIMITER		13'-5" x 1-1/4" LENNOX BAND BLADES



## **Service Contact Information**

In the event that you have any problems, call us at (573) 663-7711 any time between 8:00 AM and 5:00 PM (CST), Monday through Friday.

## **Serial Number Location**

The model and serial number are located on the top left corner of the machine.

***Please refer to your serial number and model number when speaking to a service technician or ordering replacement parts.***