

# HD-SDI Mini High Speed Dome

## Installation and Operation Manual

---

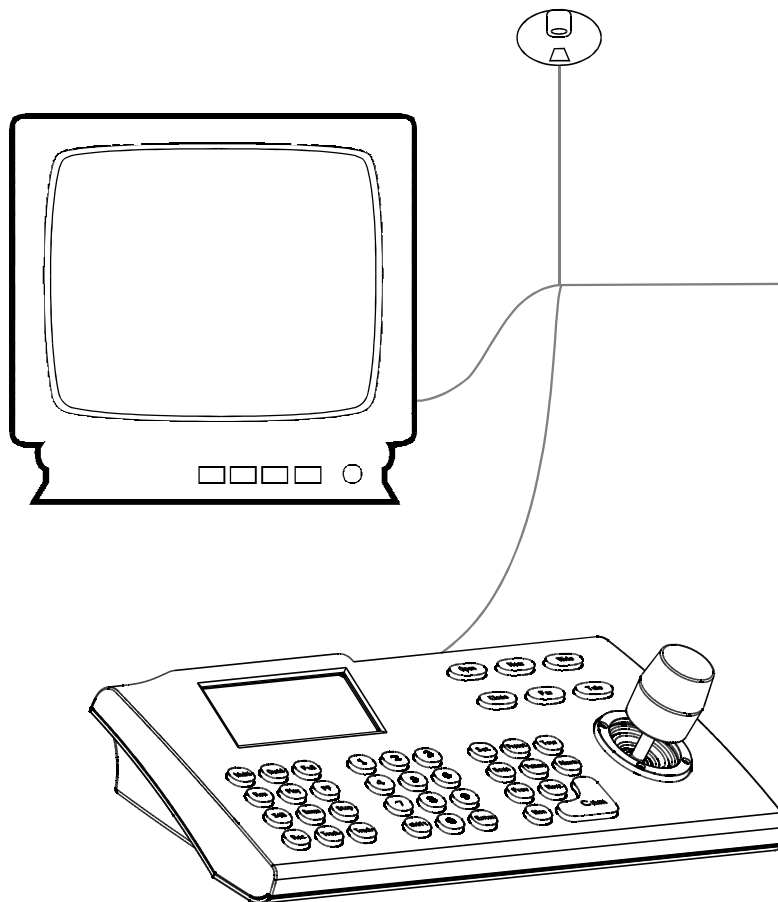

# TABLE OF CONTENT

1. Precaution-----	1
2. Performance-----	2
2.1 Dome parameter-----	2
2.2 Camera parameter-----	2
2.3 Performance and feature-----	3
3. Function instruction-----	4
3.1 Camera ID-----	4
3.2 Auto-run motion-----	4
3.3 Camera control-----	5
3.4 Monitor function-----	5
4. System setting-----	6
4.1 Basic operation-----	6
4.1.1 Self-testing-----	6
4.1.2 Call the main menu-----	6
4.1.3 Menu and keyboard operation-----	6
4.2 Edit dome label-----	7
4.3 Initial information-----	8
4.4 Display setup-----	9
4.5 Systematic motion control-----	10
4.5.1 Auto flip-----	10
4.5.2 Proportion pan-----	10
4.5.3 Park action-----	11
4.5.4 Power up action-----	11
4.5.5 Fan startup by temperature-----	11
4.5.6 Advance setting-----	12
4.6 Clear-----	13
4.7 Password setup-----	14
4.8 Clock setting -----	15
4.9 Coom setting -----	16
5. Camera setting-----	17
5.1 Zoom speed-----	17
5.2 Digital zoom control-----	18
5.3 Back light compensation-----	19
5.4 Slow shutter control-----	20
5.5 Line Sync control-----	21
5.6 WDR control-----	22
5.7 Advance setting1-----	23
5.8 Advance setting2-----	24
5.8.1 AE mode-----	24

5.8.2 White balance mode-----	25
6. Function setting -----	26
6.1 Preset -----	26
6.2 Scan-----	27
6.3 Pattern-----	28
6.4 Tour-----	29
6.5 Zone-----	30
6.6 Time running-----	31
6.7 Set auto-tracking-----	32
7. Privacy zone masking-----	33
8. Alarm function -----	34
8.1 ARM Setting -----	35
9. Appendix-----	36
9.1 Menu index-----	36
9.2 Troubleshooting-----	37
9.3 The cleaning of the down cover-----	38
9.4 24VAC Wire Diameter and Transmission Distance Comparison chart-----	38
10. Installtion instuction-----	39
10.1 Ceiling mount installation instruction-----	39
10.2 Wall mountion instruction-----	40
11. Maintenance service terms-----	41

## 1. Precaution



Please read this manual and product label carefully before installing the speed dome.

### Ø Law

The product installation and use of the product must comply with the relevant laws of the country.

### Ø Electrical safety

1. Strictly conform to country and local electrical safety standard when using or installing the product.
2. Using factory's power adapter. This dome uses 24VAC power supply. About the rated inputting voltage, please refer to power label.

### Ø Transportation

1. The dome should be protected against extremes of pressure, vibration humidity and other damage during storage and transportation.
2. The dome should be shipped in parts disassembled as the original integrated packing during the transportation. Damage caused by improper transportation is not within the warranty.

### Ø Installation with care

1. Please refer to user manual when installation, and sufficient strength of the wall or ceiling should be ensured .
2. Power must be cut off when installation.
3. Please handle with care, do not squeeze and press structure parts, which may cause mechanical damage.
4. Down cover and lens of camera are precise optical items. Please don't touch it directly to avoid scratch which will affect the image quality.

### Ø Requirements to service personnel

All the service work should be done by qualified technicians.

### Ø Do not disassemble the camera module

### Ø Environmental requirements

Operation environment temperature: -30°C - +50°C

Humidity: < 95%

Air pressure: 86-106Kpa

### Ø Don't place lens of the camera to strong light objects (like sun etc.)

### Ø Cleaning of down cover

When the image is unclear or there is much dust on the down cover, please use soft cloth to clean or use water to wash the down cover and then wipe up.

## 2.1 Dome parameter

Electrical:		Setting:	
Power supply	AC24V	Baud rate (RS485)	2400/4800/9600/19200bps
Consumption	12W	Protocol	PELCO, Kalate, Philips, Diamond, and seventeen protocols, etc.
Decoder	Built-in	Address setting	0-255
Operation:		Environmental:	
Pan rotation	360° continuously	Operational environment	Outdoor: -30 — +50°C Indoor: -10 — +50°C
Tilt rotation	Tilt90° , with auto flip	Environmental humidity	0—95% no compensation
Rotation speed	Pan0.4~320°/S Tilt0.4~150°/S	Protection grade	IP66, Weather proof housing, (outdoor) TVS1500w lightning proof surge proof (indoor/outdoor)
Alarm function	7 alarm input/2 alarm output	Physical:	
Preset	128presets	Mount	Wall, Pendant, Corner, Pole
Surveillance	Preset, Tour, Scan, Pattern		

## 2.2 Camera parameter

Spec	Model	MUS: 3x (SE600)
Imaging element		1/2.8 Type Exmor CMOS Sensor
Scanning system		Progressive scanning
Effective pixel (H × V)		2 Mega pixel
Minimum illumination		0.25lux/0.03lux
Zoom		3x optical, 12x digital
Focus		3-9(mm)
IRIS control		Auto/Manual
Focusing system		Auto/Manual
White balance		Auto/Manual
Back -light compensation		Off/No
WDR control		Yes
S/N ratio		> 50dB
Wide Dynamic Range		Off/No/Auto
Privacy zone masking		No

## **2.3 Dome performance and feature**

This product is high-technology surveillance product with high definition and color camera, variable-speed pan/tilt and multifunction decoder. It can reduce the connection and installation process between systematic parts at a max limit, and also can improve the stability and reliability of the system. Meanwhile it is easy to install and repair, and it has the following advantages: beautiful shape, rotate lightly and neatly, little noise, simple operation and so on.

### **1. Built-in digital camera**

- High sensitivity, high resolution, and integrated digital processing
- Auto-focus
- Auto brightness control
- IR cut filter
- Auto slow shutter
- Auto-Iris
- Auto white balance
- Auto back light compensation

### **2. Integrated and multi-protocol decoder**

- Figure design, all the data is stored in the inner of camera pan/tilt, when power off, the storage data won't lose.
- Built-in decoder, integrated and multi-protocol, including PELCO-D, PELCO-P, AD, PHILIPS, KALATEL, DIAMOND, PANASONIC and so on.
- 128 presets can be stored, support auto tour (but only can transfer 1-80 presets), 4 tour, each tour can store up to 16 presets
- 4 pattern
- 4 scan
- Built-in direction indicator
- Built-in temperature indicator
- Built-in clock setting
- RS485 bus controlling in series, and dome ID 1-255 (optional)

### **3. Built-in pan/tilt**

- Iron and carbon alloy structure, high intensity, and good heat dissipation
- Precise stepping motor, rotate smoothly, react sensitivity and orientate accurately
- Exquisite mechanical drive, support pan 360° continuously and tilt 0-90°, and may rotate 180° with auto flip
- Rotate slowly at pan 1° /s, and the image doesn't wobble

### **4. OSD menu**

- All the menu option is displayed in English.
- Video OSD menu. It is direct and simple to revise the dome information and parameter by keyboard and menu display.
- May set park action, and set power up action or carry out appointed action.

### **5. Internal temperature test**

- When the temperature exceeds the upper limit, the screen will display alarm information.
- According to the real-time temperature, the fan will measure if it starts or not, and prolong the life of fan.

### **6. Alarm input/output control**

When the dome receives an outer alarm signal, it will run the setted motion, until alarm released. The dome can set 4 alarm input and 1 alarm output.

## 3. Function instruction

This passage mainly describes the main function and general principle of integrated speed dome, and don't refer to the concrete operation methods. Different system platform has different operation methods, generally we should according to the system manufactory operation manual. Please contact franchiser to get necessary information, under some conditions there are have some particular requirements and operations.

### 3.1 Auto-run motion

#### 1. Auto flip

If user holds the joystick at the down position, the camera rotates pan 180 degrees, then the camera rotates tilts up to 90 degrees, you may directly watch the rear view to realize surveillance all processes in portrait 180degrees. In the menu, you may set the system parameter setting AUTO FLIP as ON, thus you may run this function.

#### 2. Park action

By the menu “ park time” and “park action” , user may set auto-call preset or run tour, pattern, and scan, etc, after pointing a few minutes if the dome doesn't run any motions.

#### 3. Power up action

By the menu “ power up action” , after the dome powers up or restarts, user may set auto- resume motions before power up and auto-call preset or run tour, pattern, and scan etc .

### 3.2 Camera control

#### 1. Magnification control

The user can adjust zoom far and near of the image by keyboard controller “Wide/Tele” to obtain panoramic image or close view that you need. The speed dome support digital zoom and optical zoom.

#### 2. Focus control

System defaults Auto focus. When the lens changes, camera will auto-adjust focus according to the centre of the image to get legible image. User also can manually focus to get desire image by operating keyboard “FAR/NEAR” . When operating keyboard joystick, camera resumes to auto focus.

The camera can not auto focus in the following status:

- Target is not in the centre of the image
- Observe the target near and far at the same time, can not be clear at the same time.
- Target is a strong light object, such as spotlight, neon light, etc.
- Target moves too fast
- Target area such as wall
- Target is too dark or vague
- Target image is too small

### **3. Iris control**

System defaults as auto Iris. Camera can rapidly adjust size of Iris, through automatically induct the changing of environment ray, and thus make the brightness of deferent image stable.

User may adjust Iris by controller keyboard “open/close” to get required brightness that you need. User also can resume auto Iris by joystick operation. When controlling the Iris manually, the dome locks current position you manually controlled; when operating joystick, the dome resume auto Iris.

### **4. Auto back light compensation**

Camera sub-area can carry out auto back light compensation. Under a strong light background, camera will auto compensate light for the darker object and adjust daylight to the bright background. In order to avoid making the image mess by the background is too high in luminance, and the object is unable to recognize because of darkness, thus gain legible image.

### **5. Auto white balance**

Camera can automatically adjust white balance in accordance with the alteration of background lightness to reach a true colour.

## **3.3 Monitor function**

### **1. Set and call preset**

Preset function is that dome stores the horizontal angle, slope angle, camera lens focus position and parameters of current pan/tilt into the memory. When necessary, dome can call these parameters, and adjust pan/tilt and camera to this position. User can call presets easily and promptly by using keyboard controlling. The dome can support 128 presets.

### **2. Tour**

Tour is the built-in function in the speed dome. It can appoint setting in advance, and make presets arranged in needful order in tour dwell. By inserting presets in tour dwell, to make the camera tour between these presets. Tour order can be programmed, each time you run tour, you can set park time. A tour can store 16 presets.

### **3. Scan**

User can easily preset right limit and left limit by controlling keyboard and menu, in order to make the camera scanned between right limit and left limit at a setting speed.

### **4. Pattern**

Pattern is built-in function in the speed dome; the dome can record the tracks that are no less than 180s, when running pattern, the dome moves repeatedly according to the recorded tracks. A dome can set up to 4 pattern.

### **5. Lens position display**

The position that the speed dome has finished to self-testing as 0 point of pan rotation and tilt rotation. The pan range is 0-360° , and tilt range is 0-90° . According to the displayed information, to set the position of camera lens, and the position can display on the screen.

## **3.4 Constant temperature function**

Inner temperature sensor check temperature inside of the dome. When the dome work at the high temperature, the dome will automatically to start-up the fan to reduce the heat, to make sure the dome work in the reliable temperature environment, increase its stability and prolong the life time of the dome.



## 4. System setting

### 4.1 Basic operation

#### 4.1.1 Self-testing

The dome conducts self-testing after current-carrying, and it rotates slowly until displaying pan origin that is default setting, then moving to tilt origin, the lens will be pulled far to near and near to far, when self-testing is finished, there is relevant system information displaying on the screen, as follow:

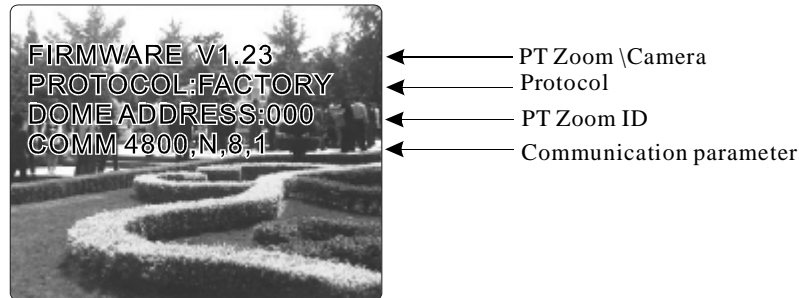

The information will not disappear until you stop to operate the system. If you set “power up action”, the dome will automatically activate motions after self-testing. How to operate the function? We will explain detail introduction in following passages.

#### 4.1.2 Call the main menu

The system enters into the main menu by calling 95 preset or 9 preset twice within 3 seconds. All the menu setting must enter into the main menu at first. You need input password when you sign in the menu if you set up password and have a super- password for the time of forget the password (super-password "892226"), then the password will turn to factory setting (original password "000000"). You need set the password again if you need it, the detail of information show in password setting 6.7

#### 4.1.3 Menu and keyboard operation

##### 1. Basic operations

##### Ø Keyboard operation:

【OPEN】 when choosing pictures, it means to increase Iris; when setting menu, it means to enter into the next menu or setting, or save after finishing setting.

【Close】 when choosing pictures, it means to reduce Iris; close to cancel.

【FAR】 Focus to far

【NEAR】 Focus to near

【TELE】 Increase magnification

【WIDE】 Reduce magnification

Joystick to up: When choosing menu, it means to choose the former one; when choosing picture, it means camera tilt up.

Joystick to down: when choosing menu, it means to choose the next one; when choosing picture, it means camera tilt down.

Joystick to left: when choosing menu, it is equal with 【Close】, when choosing picture, it means camera tilt left.

Joystick to right: when choosing menu, it is equal with 【Open】, when choosing picture, it means camera tilt right.

Press 【TELE】 and 【WIDE】 at the same time, it means 3D joystick rotates joystick cap.

##### Ø Menu operation

“Back” : Back to the former menu

“Exit” : Exit menu

“On” : Open one setting

“Off” : Close one setting

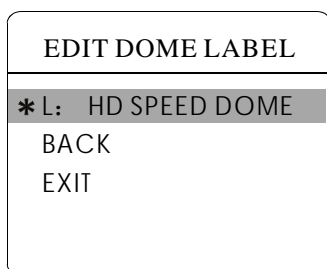
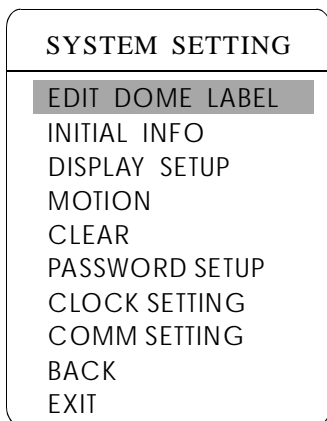
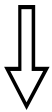
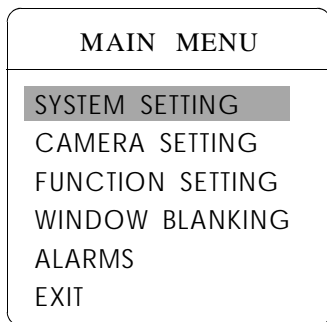

## 4.2 Edit dome label

When using a lot of domes' systems, in order to identify each dome, the systems support title setting. The setting ways as follow:

1. The system enters into the main menu by calling 95 preset or by calling 9 preset twice within 3 seconds.
2. Operate joystick and move cursor to **【SYSTEM SETTING】**, and press **【OPEN】** to enter into the next menu.
3. Operate joystick and move cursor to **【EDIT DOME LABEL】**, and press **【OPEN】** to enter into the label setting menu.
4. Operate joystick and move cursor to **【LABEL】**, and press **【OPEN】** to edit current label.
5. When the cursor is twinkling in the first character of the label, to move joystick to choose character, after editing, pressing **【OPEN】** to save.
6. Moving cursor to **【BACK】** and pressing **【OPEN】** to back to the former menu.

The label may set 16 characters, and doesn't need editing characters. Pressing **【OPEN】** continuously to jump over and using spacebar to replace the deleted characters. When you finish to edit a character, press **【OPEN】** to enter into the next editing character; when you editing the last character, pressing **【OPEN】** to save. Press **【Close】** to exit.



**NOTICE**

Character of label is suitable for choosing as follow: 0-9, A-Z, &\*? !, "\*" to show Space.

Other labels' input ways are the same as above.

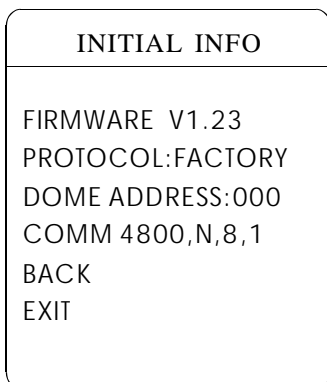
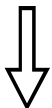
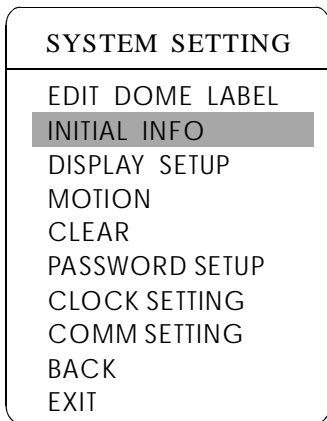
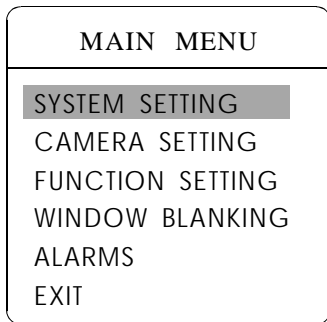

## 4.3 Initial information

1. The system enters into the main menu by calling 95 preset or by calling 9 preset twice within 3 seconds.

2. Operate joystick and move cursor to **【SYSTEM SETTING】** , press **【OPEN】** to enter submenu.

3. Operate joystick and move cursor to **【INITIAL INFO】** , press **【OPEN】** to display initial information which as below the left picture shows:

Initial information includes S/N of the dome, soft edition, Protocol, Dome ID, communication parameter. System setting may change the numerical value of initial information.

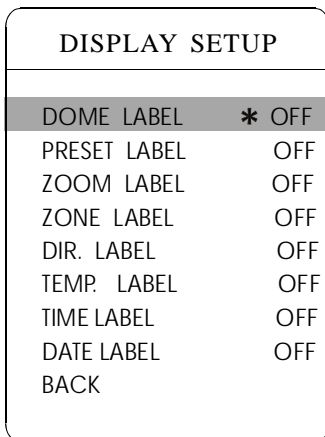
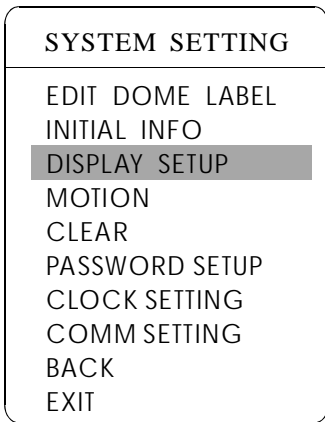
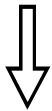
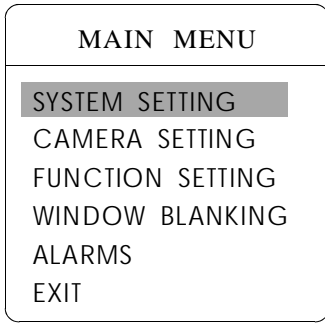

## 4.4 Display setup

1. The system enters into the main menu by calling 95 preset or by calling 9 preset twice within 3 seconds.
2. Operate joystick and move cursor to **【SYSTEM SETTING】** , press **【OPEN】** to enter submenu.
3. Operate joystick and move cursor to **【DISPLAY SETUP】** , press **【OPEN】** to enter “display setup” menu, may setting the content of the display setup as follow:
  - **【DOME LABEL】**
  - **【PRESET LABEL】**
  - **【ZOOM LABEL】**
  - **【ZONE LABEL】**
  - **【DIRECTION LABEL】**
  - **【TEMPERATURE LABEL】**
  - **【TIME LABEL】**
  - **【DATE LABEL】**

4. Taking display dome label as an example to explain the operation process. Tilt up/down joystick to move cursor to **【DOME LABEL OFF】** , press **【OPEN】** , there is a sign “\*” besides **【DOME LABEL】** , the cursor is twinkling besides **【OFF】** , as left picture shows;

5. Joystick tilts up/down, setting number changes between ON/OFF, when setting **【ON】** , it means to display “dome label” ; when setting **【OFF】** , it means not to display “dome label” . When pressing **【OPEN】** , the cursor jump back in front of **【DOME LABEL】** , means label setting is finished, when moving the cursor to **【BACK】** , it means exiting the current menu setting.

The displaying information on the screen will change with the dome rotation. Through the information on the screen, user can see dome current inside temperature, magnification, display zone etc. When all the label are displayed, the dome works as the following picture shows.:(In the picture “305” means pan angle, “45” means tilt angle.)

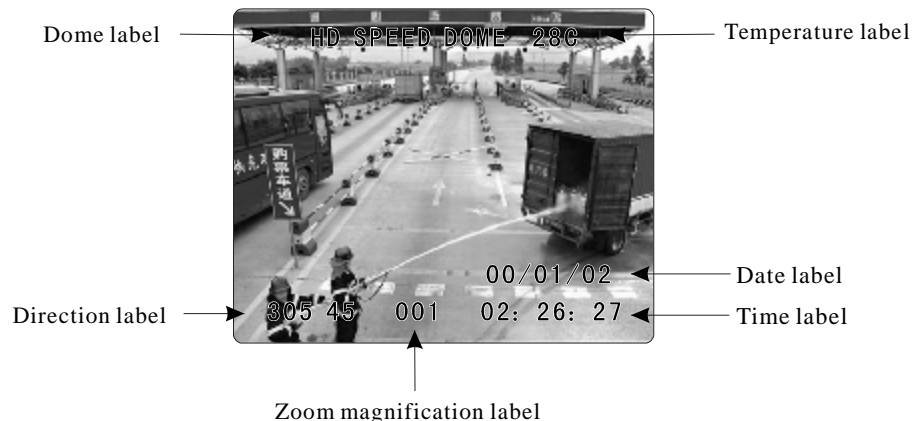

MAIN MENU
SYSTEM SETTING
CAMERA SETTING
FUNCTION SETTING
WINDOW BLANKING
ALARMS
EXIT



SYSTEM SETTING
EDIT DOME LABEL
INITIAL INFO
DISPLAY SETUP
MOTION
CLEAR
PASSWORD SETUP
CLOCK SETTING
COMM SETTING
BACK



MOTION	
AUTO FLIP	* ON
PROPORTION	ON
PARK TIME	005
PARK ACTION	SCAN
POWER ACTION	AUTO
FAN ENABLED	050C
TEMP C/F	CENT.
ADVANCE SETTING	
BACK	

## 4.5 Systematic motion control

Systematic motion controlling may control a series of canonical movement of the dome, and plays an important role in controlling the image of the dome.

1. The system enters into the main menu by calling 95 preset or by calling 9 preset twice within 3 seconds.
2. Operate joystick and move cursor to **【SYSTEM SETTING】**, press **【OPEN】** to enter submenu.
3. Operate joystick and move cursor to **【MOTION】**, press **【OPEN】** to enter systematic motion controlling menu, as left picture shows.

### 4.5.1 Auto flip

1. Operate joystick, move the cursor to **【AUTO FLIP】**: press **【OPEN】** to enter “auto flip” setting, tilt up/down joystick, for example: choosing ON to open “auto flip”; choosing OFF to close “auto flip”. Press **【OPEN】** to save.

#### OPERATION KNACKS

When opening the auto flip function, user holds the joystick in the down position, the camera rotates pan 180 degrees, after the camera rotates tilts up to 90 degrees, you may directly watch the rear view to surveillance all processes in portrait 180 degrees.

### 4.5.2 Proportion pan

- Operate joystick, move the cursor to **【PROPORTIONAL】**; press **【OPEN】** to enter “proportion pan” setting, tilt up/down joystick to choose, if choosing **【ON】**, it means to open proportion pan; if choosing **【OFF】**, it means to close proportion pan, press **【OPEN】** to save.

#### OPERATION KNACKS

When manually adjusting, for far focus situation, the dome responds at a high-speed so that touching rocker slightly may make picture move rapidly, thus cause the picture to lose. To base on humanized design, the dome automatically adjust pan and tilt rotation according to zoom near and far, which make it is convenient to operate manually run after object.

MOTION	
AUTO FLIP	ON
PROPORTION	ON
PARK TIME	005
PARK ACTION *	SCAN
POWER ACTION	AUTO
FAN ENABLED	050C
TEMP C/F	CENT.
ADVANCE SETTING	
BACK	



MOTION	
AUTO FLIP	ON
PROPORTION	ON
PARK TIME	005
PARK ACTION	SCAN
POWER ACTION *	AUTO
FAN ENABLED	050
TEMP C/F	CENT.
ADVANCE SETTING	
BACK	

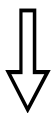

MOTION	
AUTO FLIP	ON
PROPORTION	ON
PARK TIME	005
PARK ACTION	SCAN
POWER ACTION	AUTO
FAN ENABLED *	050C
TEMP C/F	CENT.
ADVANCE SETTING	
BACK	

### 4.5.3 Park action

This setting allows the dome to run an appointed action after it enters vacancy for a few time (1-240minutes). If default sets as 0, it means not to run this action.

1. Operate joystick and move the cursor to **【PARK TIME】**, press **【OPEN】** to tilt up/down joystick to set park time, the range is 0-240 (minute), press **【OPEN】** to save. **【PARK ACTON】** is running action at a park time, when **【PARK TIME】** sets as 0, this item can't be set.

2. Operate joystick, move the cursor to **【PARK ACTON】**, press **【OPEN】** there will be a sign “\*” in the front of **【PARK ACTON】**, the cursor jumps to right, after tilting up/down joystick to choose “park action”, there are options for choosing as follow, press **【OPEN】** to save.

- **【NONE】** - (default) none action
- **【PRESET】** -use preset 1
- **【SCAN】** -run scan
- **【PAT】** - run pattern
- **【TOUR】** - run tour

### 4.5.4 Power up action

The dome startup to run actions after self-testing, if nobody intervenes with it, the dome will repeatedly run this action continuously, default sets as **【NONE】**.

1. Operate joystick, move the cursor to **【POWER UP ACTION】**: press **【OPEN】** to jump the following choice, tilt up/down joystick to choose “power up action”, press **【OPEN】** to save.

- **【NONE】** - none action
- **【AUTO】** - the dome resumes the primary action and direction before power up.

- **【PRESET】** - use preset
- **【SCAN】** - run scan
- **【PAT1】** - run pattern
- **【TOUR】** - run tour

### 4.5.5 Fan startup by temperature

The temperature of the dome will rise when its environment is in high temperature. The fan will open automatically when the temperature reaches to a temperature value in order to make sure the stability of the dome.

Operate joystick, move the cursor to **【FAN ENABLED】**: press **【OPEN】**, the cursor will skip to the back option. The user can choose the fan to start up temperature, and press **【OPEN】** to save it in actual condition.

The default setting temperature of the fan startup is 45°C. The user also can enter into the fan startup setting to adjust the temperature of fan startup. As picture shows: the temperature range is 0-60°C. **【TEMP】** can switch the temperature between Fahrenheit and Centigrade.

MOTION	
AUTO FLIP	ON
PROPORTION	ON
PARK TIME	005
PARK ACTION	SCAN
POWER ACTION	AUTO
FAN ENABLED	050C
TEMP C/F	CENT.
ADVANCE SETTING	
BACK	



ADVANCE SETTING	
EIS ENABLED	OFF
PRESET FREEZE	OFF
AUTO FOCUS	ON
DEFOGGER	015C
HEAD UP	OFF
BACK	
EXIT	

## 4.5.6 Advance setting

1. Operate joystick and move the cursor to **【ADVANCE SETTING】**, press **【OPEN】** to enter into advance setting;

- **【EIS ENABLED】** : Electronic Image Stabilizer function.
- **【PRESET FREEZE】** : means the image will be frozen at the point that you call the new preset, until the camera totally gets the new preset, the freezed image can be released.
- **【AUTO FOCUS】** : Choose ON/OFF to open/close the auto focus of the dome.
- **【DEFOGGER】** : Clear cover will be fogged when the dome works in quite cold temperature. In order to ensure to get clear image, defogger runs at the appointed temperature. Choosing **【DEFOGGED】** by operating the joystick, and press **【OPEN】** and enter into the next buttons. Please choose the temperature lever to run the defogged, and press **【OPEN】** to save. Range of temperature: 0~30°C
- **【HEAD UP】** : When dome used as head down, pls choose “ON” , or choose “OFF”

### OPERATION KNACKS

After the dome set the EIS function, if the dome wobble slight when running, the camera will shield the wobble picture and make the picture calm and smooth.



**NOTICE**

These function in the advance setting menu depends on the models and parameters of built-in camera in dome, if the camera doesn't have this function, then this function is invalid. The option is useless (N/A) when the camera module has no such function.

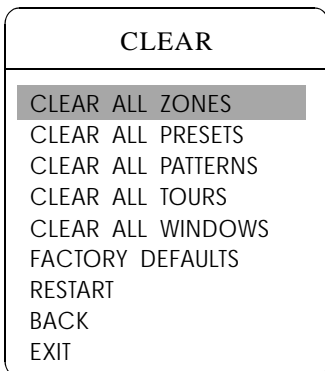
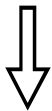
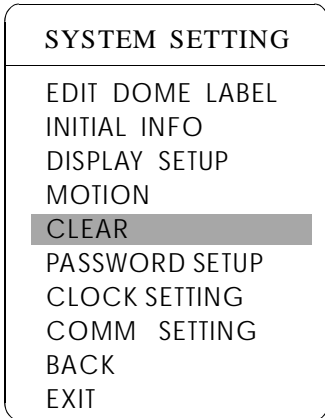
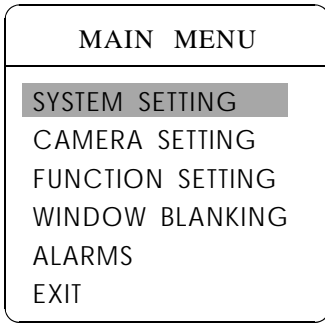

## 4.6 Clear

1. The system enters into the main menu by calling 95 preset or by calling 9 preset twice within 3 seconds.

2. Operate joystick and move cursor to **【SYSTEM SETTING】**, press **【OPEN】** to enter submenu.

3. Operate joystick and move cursor to **【CLEAR】**, press **【OPEN】** to enter submenu, as left picture shows.

- **【CLEAR ALL ZONES】**
- **【CLEAR ALL PRESETS】**
- **【CLEAR ALL PATTERNS】**
- **【CLEAR ALL TOURS】**
- **【CLEAR ALL WINDOWS】**
- **【FACTORY DEFAULTS】**: resume the factory default. Run this function, the camera parameter and system parameter will resume before production, clear all windows and alarm setting. Please be cautious to use this function.
- **【RESTART】**

4. Set clear zone as an example to explain the process. Tilt up/down joystick to **【CLEAR ALL ZONES】**, press **【OPEN】** to clear all zones.



**NOTICE**

Once clear all commands in the controlling menu, it can't resume, so please be careful of using it.



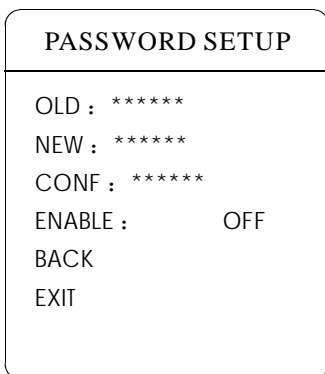
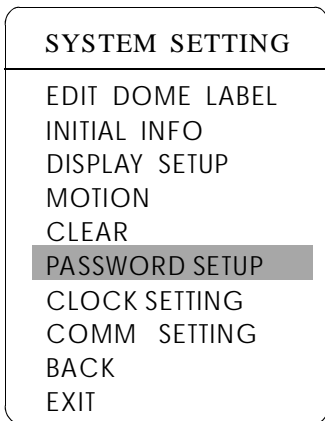
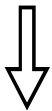
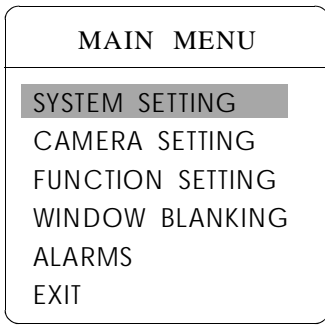

## 4.7 Password setup

1. Call 95 preset or call 9 preset twice within 3 seconds and then input the password to enter the main menu.
2. Operate the joystick and move the cursor to **【SYSTEM SETTING】** , press **【OPEN】** to call the submenu.
3. Operate the joystick and move the cursor to **【PASSWORD SETUP】** , press **【OPEN】** to call the submenu. Please refer to the left picture.
4. Operate the joystick and move the cursor to **【OLD PASSWORD】** , press **【OPEN】** to choose it, operate the joystick right and left to input the password, Tilt up and down to choose the number which you need.
  - **【NEW PASSWORD】** Enter the new password
  - **【CONFIRM PASSWORD】** Confirm the new password
  - **【ENABLE PASSWORD】** Set password ON/OFF

The password function is noneffective under PASSWORD OFF. It means that user can enter into the main menu without password. (The password function is effective under the password ON.) It means user need input password to enter into the main menu.



**NOTICE**

When user forgot the password and can not enter into the main menu, he can use the super password to enter, which is "892226". At this time, the password of dome will change to initial one, which is "000000", and then user may set the password by himself again.

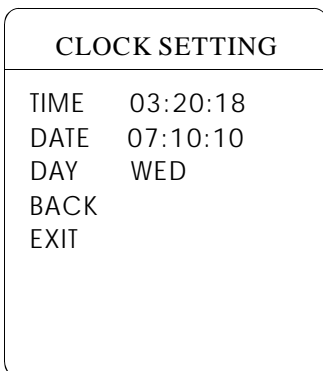
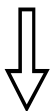
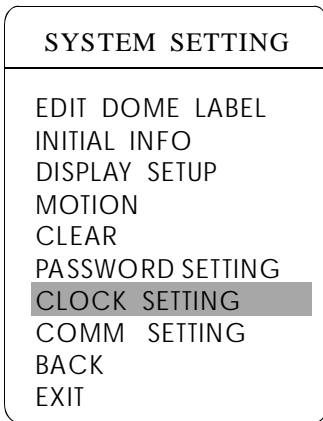
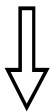
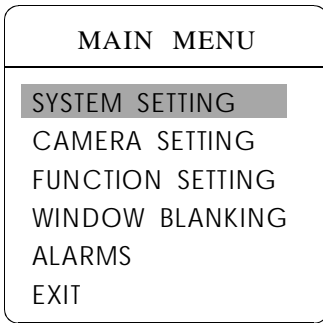

## 4.8 Clock setting

1. Call 95 preset or call 9 preset twice within 3 seconds and then input the password to enter into the main menu.

2. Operate the joystick up and down and move the cursor to **【SYSTEM SETTING】** press **【OPEN】** to call the submenu.

3. Operate the joystick up and down and move the cursor to **【CLOCK SETTING】** press **【OPEN】** to call the submenu. Please refer to the left picture.

4. Operate the joystick and move the cursor to **【TIME】** , press **【OPEN】** to choose it, move the joystick up and down to choose the number you need, move the joystick right and left to set hour, minute, second.

- **【DATE】** set year, month, date
- **【DAY】** set week
- **【BACK】** return to the former menu
- **【EXIT】** exit the main menu

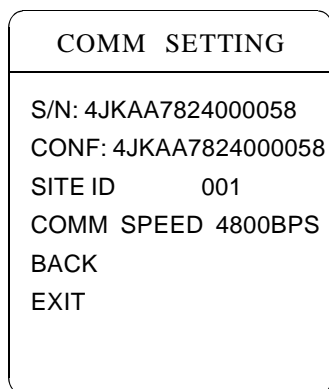
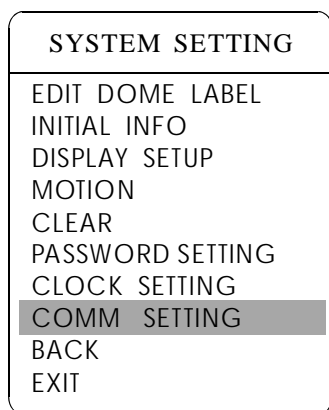
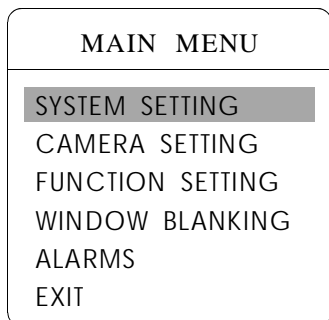

## 4.9 COMM. Setting

1. The system enters into the main menu by calling 95 preset or by calling 9 preset twice within 3 seconds.
2. Operate joystick and move the cursor to **【SYSTEM SETTING】** , press **【OPEN】** to enter into the next menu.
3. Operate joystick and move the cursor to **【COMM SETTING】** , press **【OPEN】** to enter into dome parameter setup menu.

**S/N:** show Series NO. of the dome ex-work.

**CONF:** to confirm the series number of the dome, it should be the same as the S/N.

**SITE ID:** setting up the ID number of the dome, address scope (001-255).

**COMM SPEED:** Baud rate setup. The user can choose 4 kinds of Baud rate (2400 BPS, 4800 BPS, 9600 BPS, 19200 BPS).

**PROTOCOL:** set protocol, the user can choose 16 kinds of protocol: PELCO, FACTORY, DYNACOLOR, ISD, HUNDA, VIDO B02, LILIN, KALATEL, DIAMOND, SAMSUNG , PANASONIC, SANTACHI, VICON, MOLYNX, VCL, SAE.

 <b>NOTICE</b>	These operation can't be continued if two series number are not the same.
------------------------------------------------------------------------------------------------------	---------------------------------------------------------------------------

## 5. Camera setting

### 5.1 Zoom speed

1. The system enters into the main menu by calling 95 preset or by calling 9 preset twice within 3 seconds.
2. Operate joystick and move cursor to **【CAMERA SETTING】** , press **【OPEN】** to enter submenu.
3. Operate joystick and move cursor to **【ZOOM SPEED】** ; press **【OPEN】** "**\***" will appear in the front of **【HIGH】** , the cursor moves to right, tilt up/down joystick to choose **【HIGH】** or **【LOW】** .
4. Press **【OPEN】** to save, press **【CLOSE】** to cancel.

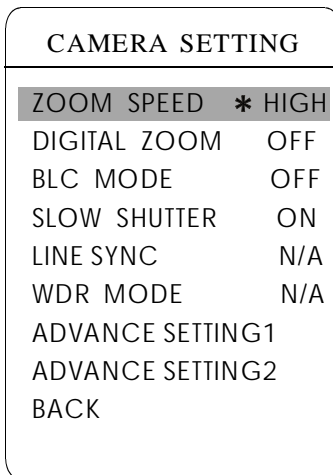
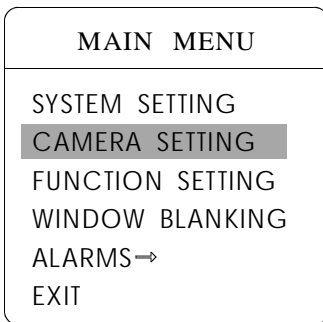

MAIN MENU	
SYSTEM SETTING	
<b>CAMERA SETTING</b>	
FUNCTION SETTING	
WINDOW BLANKING	
ALARMS	
EXIT	



CAMERA SETTING	
ZOOM SPEED	HIGH
<b>DIGITAL ZOOM</b>	<b>*OFF</b>
BLC MODE	OFF
SLOW SHUTTER	ON
LINE SYNC	N/A
WDR MODE	N/A
ADVANCE SETTING1	
ADVANCE SETTING2	
BACK	
EXIT	

## 5.2 Digital zoom control

1. The system enters into the main menu by calling 95 preset or by calling 9 preset twice within 3 seconds.
2. Operate joystick and move cursor to **【CAMERA SETTING】** , press **【OPEN】** to enter camera setting.
3. Operate joystick, move the cursor to **【DIGITAL ZOOM】** , press **【OPEN】** to enter digital zoom setting, tilt up/down joystick, to choose ON means open digital zoom control which is digital zoom is pulled near, if pulling the digital zoom near again, the dome enters into “ digital zoom increase” ; to choose OFF means to close digital zoom control.
4. Press **【OPEN】** to save.

### OPERATION KNACKS

When digital zoom be set as ON, the maximum zoom magnification of the dome is digital zoom magnification times optical zoom magnification; when digital zoom be set as OFF, the maximum zoom magnification of the dome is optical zoom magnification.

The option of the digital zoom is ON/OFF when the camera module is SONY, LG, CNB, HITACHI .



**NOTICE**

When shows N/A, it means this camera module does not have this function.

MAIN MENU	
SYSTEM SETTING	
<b>CAMERA SETTING</b>	
FUNCTION SETTING	
WINDOW BLANKING	
ALARMS	
EXIT	

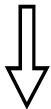

CAMERA SETTING	
ZOOM SPEED	HIGH
DIGITAL ZOOM	OFF
<b>BLC MODE</b>	<b>* OFF</b>
SLOW SHUTTER	ON
LINE SYNC	N/A
WDR MODE	N/A
ADVANCE SETTING1	
ADVANCE SETTING2	
BACK	
EXIT	

## 5.3 Back light compensation

1. The system enters into the main menu by calling 95 preset or by calling 9 preset twice within 3 seconds.
2. Operate joystick and move cursor to **【CAMERA SETTING】** to enter submenu.
3. Operate joystick and move cursor to **【BLC MODE】**, press **【OPEN】**, There will be a sign “\*” in the front of **【BLC MODE】**, tilt up/down joystick to open or close back light compensation function. If choosing ON means to open back light compensation mode; if choosing OFF means to close back light compensation mode. Different camera, different BLC options:

- 【HLC H】** High light compensation
- 【HLC L】** Low light compensation
- 【WDR H】** WDR High level
- 【WDR M】** WDR Medium level
- 【WDR L】** WDR Low level

Notes: When it shows N/A, it means this camera module does not have this function.

4. Press **【OPEN】** to save.



Non-use back light compensation, in strong sunshine, the back light side is subject to dark.



Use back light compensation, the image is in gear.

### OPERATION KNACKS

Strong background ray can make backlighting objects engender shadow, (back light compensation), the speed dome can auto-adjust iris to match with the changes of various ray, and auto-revise the main lightness to make the pictures more legible.



**NOTICE**

This function relates to models and parameters of the built-in camera in the dome, when open black compensation, it has two functions which are auto-adjust (when you choose ON) or manual adjust(0-255) according to the different of the camera.

MAIN MENU	
SYSTEM SETTING	
<b>CAMERA SETTING</b>	
FUNCTION SETTING	
WINDOW BLANKING	
ALARMS	
EXIT	



CAMERA SETTING	
ZOOM SPEED	HIGH
DIGITAL ZOOM	OFF
BLC MODE	OFF
<b>SLOW SHUTTER * ON</b>	
LINE SYNC	N/A
WDR MODE	N/A
ADVANCE SETTING1	
ADVANCE SETTING2	
BACK	
EXIT	

## 5.4 Slow shutter control

1. The system enters into the main menu by calling 95 preset or by calling 9 preset twice within 3 seconds.
2. Operate joystick and move cursor to **【CAMERA SETTING】** to enter submenu.
3. Operate joystick and move cursor to **【SLOW SHUTTER】**, press **【OPEN】**, there will be a sign “\*” in the front of **【SLOW SHUTTER】**, tilt up/down joystick to “slow shutter” choice, if choosing ON means to open slow shutter function, if choosing OFF means close “slow shutter” function. Some cameras have more options for light time of slow shutter, from X2-X128.
4. Press **【OPEN】** to save.

### OPERATION KNACKS

When the dome monitors at night or dark environment, because the ray is not enough, the image on the screen is too dark, setting slow shutter can lengthen the time of lighting so that make the picture that is shoot in dark more legible.



**NOTICE** This function depends on the models and parameters of built-in camera in dome, if the camera doesn't have this function, then this function is invalid.

MAIN MENU	
SYSTEM SETTING	
<b>CAMERA SETTING</b>	
FUNCTION SETTING	
WINDOW BLANKING	
ALARMS	
EXIT	

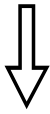

CAMERA SETTING	
ZOOM SPEED	HIGH
DIGITAL ZOOM	OFF
BLC MODE	OFF
SLOW SHUTTER	ON
<b>LINE SYNC</b>	<b>* N/A</b>
WDR MODE	N/A
ADVANCE SETTING1	
ADVANCE SETTING2	
BACK	
EXIT	

## 5.5 Line sync control

1. The system enters into the main menu by calling 95 preset or by calling 9 preset twice within 3 seconds.
2. Operate joystick and move the cursor to **【CAMERA SETTING】**, press **【OPEN】** to enter submenu.
3. Operate joystick and move the cursor to **【LINE SYNC】**; press **【OPEN】**, tilt up/down joystick to set line sync. Line sync can divide two kinds: internal/external, choose OFF is internal sync; choose ON is external sync.
4. Press **【OPEN】** to save.

### OPERATION KNACKS

When a lot of domes use a line in the same time, if the image is twinkling as switching, please set each dome as external line and adjust the numerical value of external line.



**NOTICE**

This function is relative with the model and parameter of the camera module which insert in the dome. The option is useless(N/A) when the camera module does not have this function.



MAIN MENU	
SYSTEM SETTING	
<b>CAMERA SETTING</b>	
FUNCTION SETTING	
WINDOW BLANKING	
ALARMS	
EXIT	



CAMERA SETTING	
ZOOM SPEED	HIGH
DIGITAL ZOOM	OFF
BLC MODE	OFF
SLOW SHUTTER	ON
LINE SYNC	N/A
<b>WDR MODE</b>	<b>* N/A</b>
ADVANCE SETTING1	
ADVANCE SETTING2	
BACK	
EXIT	

## 5.6 WDR Control

1. The system enters into the main menu by calling 95 preset or by calling 9 preset twice within 3 seconds.
2. Operate joystick and move the cursor to **【CAMERA SETTING】** , press **【OPEN】** , Enter the next main menu
3. operate joystick and move the cursor to **【WDR MODE】** , press **【OPEN】** , tilt up/down joystick to set WDR. Choice ON is open WDR Function, choice off is closed WDR, if you choice Auto, Than mean Auto setting WDR.
4. Press **【OPEN】** to save.



**NOTICE**

This function is relative with the model and parameter of the camera module which insert in the dome. The option is useless(N/A)when the camera module does not have this function.

MAIN MENU
SYSTEM SETTING
CAMERA SETTING
FUNCTION SETTING
WINDOW BLANKING
ALARMS
EXIT



CAMERA SETTING
ZOOM SPEED      HIGH
DIGITAL ZOOM    OFF
BLC MODE        OFF
SLOW SHUTTER    ON
LINE SYNC        N/A
WDR MODE        N/A
ADVANCE SETTING1
ADVANCE SETTING2
BACK
EXIT



ADVANCE SETTING1
B&W              AUTO
BLACK TIME      N/A
COLOR TIME      N/A
THRESHOLD      10dB
MAX GAIN        08dB
EXPOS. COMP    OFF
MIRROR          OFF
FLIP             OFF
NEXT

NEXT
SHARPNESS      005
PS SCAN         OFF
STABLE ZOOM    OFF
DNR             OFF
VIDEO MODE    1080I60
BACK
EXIT

## 5.7 Advance setting 1

1. The system enters into the main menu by calling 95 preset or by calling 9 preset twice within 3 seconds.

2. Operate joystick and move the cursor to **【CAMERA SETTING】** to enter submenu.

- **【B&W】** : Day/Night switch
- **【BLACK TIME】** : Day time switch
- **【COLOR TIME】** : Night time switch
- **【THRESHOLD】** : sensitivity of switch between B/W and color.

The higher numerical value means lower sensitivity and longer switch time. In contrast, the lower numerical value means higher sensitivity and shorter switch time (Range: 8-28 dB)

- **【MAX GAIN】** : it is the maximum limit of auto gain. Range: 8-28 dB. While under poor light situation, the lower numerical value means dark & less snowflake point image. In contrast, the higher numerical value means light & more snowflake point image.

- **【EXPOSURE COMP】** : Exposure compensation (ON/OFF)
- **【MIRROR】** : Image mirror (ON/OFF)
- **【FLIP】** : 180° Image flip function (ON/OFF)
- **【SHARPNESS】** : Image sharpness (Range:00-15)
- **【PS SCAN】** : Interlacing and Multi line scan (OFF is Interlacing, ON is Multi-line)
- **【STABLE ZOOM】** : Stable zoom function(ON to open/ OFF to close)
- **【DNR】** : Image denoising function (Range:01-15)
- **【VIDEO MODE】** : Image input format, Range:1080I/60, 1080I/50, 1080P/30, 1080P/25, 720P/60, 720P/50,  
It will be valid after break off power 2 times.

3. Press **【OPEN】** to save.

### OPERATION KNACKS

IR cut filter function uses color in day; use black and white at night. This function not only guarantees the quality of image, but also saves the room of storage



**NOTICE**

This function depends on the models and parameters of built-in camera in dome, if the camera doesn't have this function, then it is invalid(N/A).

MAIN MENU	
SYSTEM SETTING	
<b>CAMERA SETTING</b>	
FUNCTION SETTING	
WINDOW BLANKING	
ALARMS	
EXIT	



CAMERA SETTING	
ZOOM SPEED	HIGH
DIGITAL ZOOM	OFF
BLC MODE	OFF
SLOW SHUTTER	ON
LINE SYNC	N/A
WDR MODE	N/A
ADVANCE SETTING1	
<b>ADVANCE SETTING2</b>	
BACK	
EXIT	



ADVANCE SETTING	
<b>AE MODE</b>	<b>AUTO</b>
SHUTTER	N/A
IRIS	N/A
BRIGHT	N/A
WB MODE	AUTO
R GAIN	N/A
B GAIN	N/A
HI-RESOLU	108
BACK	

## 5.8 Advance setting 2

1. The system enters into the main menu by calling 95 preset or by calling 9 preset twice within 3 seconds.
2. Operate joystick and move the cursor to **【CAMERA SETTING】** to enter submenu.
3. Operate joystick and move the cursor to **【ADVANCE SETTING】**; press **【OPEN】** to enter submenu, as left picture shows;

### 5.8.1 AE mode

1. Operate joystick and move the cursor to **【AE MODE】**, press **【OPEN】**, tilt up/down joystick to choose AE mode, modes for choosing as follow:
  - **【AUTO】**: default setting, auto Iris mode
  - **【BRIGHT】**: brightness priority mode
  - **【IRIS】**: iris priority mode
  - **【SHUTTER】**: shutter priority mode
  - **【MANUAL】**: manual priority mode
2. Choose iris priority mode **【IRIS】**, press **【OPEN】** to save.
3. Move joystick to the sub-choices of AE mode **【IRIS F1.4】**, press **【OPEN】** to choose adequate Iris, press **【OPEN】** to save.
  - **【SHUTTER 1/50】** it means shutter speed, when AE mode is shutter priority, this function can be set.
  - **【IRIS F1.4】** it means the size of iris, when AE mode is iris priority, this function can be set.
  - **【BRIGHT F2.0/ODB】** it means brightness, when AE mode is brightness priority, this function can be set.

#### OPERATION KNACKS

Quality of photo relates to exposure amount, that is to say how much light can make CCD receives legible image. Exposure amount is relative to the time of lighten (be up to shutter speed) and the area of lighten (be up to the size of iris).

The camera can automatically calculate suitable exposure amount according to brightness of scenery and CCD sensitivity, in the situation that the exposure amount is certain: **【SHUTTER】** (shutter priority) is to fix shutter speed, the camera will auto decide to use how much iris; **【IRIS】** (iris priority) is to fix the size of iris, and auto-decide to use shutter speed. **【BRIGHT】** (brightness priority) is point that the camera TTL check the light directly and control the brightness of image.

MAIN MENU	
SYSTEM SETTING	
<b>CAMERA SETTING</b>	
FUNCTION SETTING	
WINDOW BLANKING	
ALARMS	
EXIT	

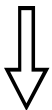

CAMERA SETTING	
ZOOM SPEED	HIGH
DIGITAL ZOOM	OFF
BLC MODE	OFF
SLOW SHUTTER	ON
LINE SYNC	N/A
WDR MODE	N/A
ADVANCE SETTING1	
<b>ADVANCE SETTING2</b>	
BACK	



ADVANCE SETTING	
AE MODE	AUTO
SHUTTER	N/A
IRIS	N/A
BRIGHT	N/A
<b>BW MODE * AUTO</b>	
R GAIN	N/A
B GAIN	N/A
HI-RESOLU	108
BACK	

## 5.8.2 White balance mode

System supports **【AUTO】** , indoor mode **【INDOOR】** , outdoor mode **【OUTDOOR】** , auto track mode **【ATW】** , single mode ,manual mode **【MANUAL】** and kinds of white balance modes, etc.

Detail setting as follow:

1. The system enters into the main menu by calling 95 preset or by calling 9 preset twice within 3 seconds. click each command enter into “ advanced setting” menu according to the order in left picture .

2. Operate joystick and move the cursor to **【WB MODE】** to choose white balance mode, press **【OPEN】** to save.

Auto mode **【AUTO】** is the default mode of speed dome, which is auto-revert real color after the white balance sensor check the environment by camera. When choosing manual mode **【MANUAL】** , adjust the numerical value of **【R GAIN】** and **【B GAIN】** .

- **【R GAIN】** the range is 1-225; the numerical value is bigger, it means that adding red is more, the tone changes to be warm.

- **【B GAIN】** the range is 1-225; the numerical value is bigger, it means that adding green is more, the tone changes to be cold.

Indoor mode **【INDOOR】** , and the tone leans to cold.

Outdoor mode **【OUTDOOR】** , and the tone leans to warm.

- **【HI-RESOLUTION】** high resolution is built-in function of camera ,this function is relative with the model of camera.



**NOTICE**

It is possible that different camera has not the setting of **【INDOOR】** , **【OUTDOOR】** , **【HI-RESOLUTION】** . That means the current camera has no such function when the setting option shows N/A.

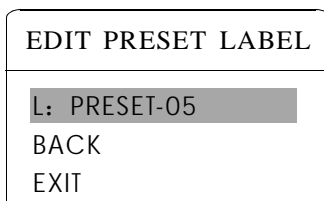
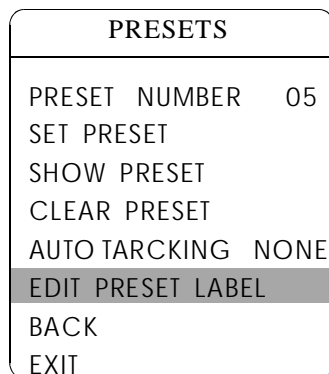
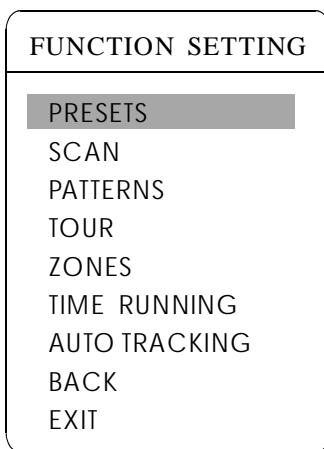
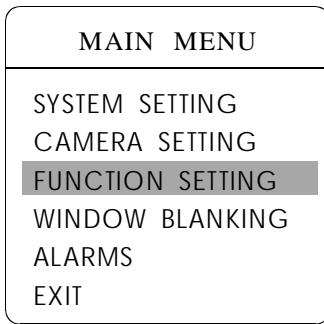

## 6. Function setting

### 6.1 Preset

1. The system enters into the main menu by calling 95 preset or by calling 9 preset twice within 3 seconds. Click each command to enter “preset menu” according to the order of the left picture. As follows:

- **【PRESET NUMBER】**
- **【SET PRESET】**
- **【SHOW PRESET】**
- **【CLEAR PRESET】**
- **【AUTO TARCKING】** (If the dome does not have this function, it won t display )
- **【EDIT PRESET LABEL】**

Define preset and call preset function can be set by keyboard operation, input preset number at first, then click the key “save /call preset” to carry out.

2. Define current preset number: move the cursor to **【PRESET NUMBER】** , press **【OPEN】** to choose preset number, the range is 1-128 as the left picture shows, here chooses number 5 as current preset, the following operations aim at the current preset.

3. Define current preset: move the cursor to **【SET PRESET】** ,press **【OPEN】** , by operating joystick to adjust magnification, to choose good objective image, press **【OPEN】** to save. If the image is very near, the Image is belong in digital zoom. When setting preset, the image will jump to maximal optical zoom.

#### OPERATION KNACKS

Preset function is that dome stores current pan/tilt angle, zoom and other position parameters into the memory. When necessary,dome recalls these parameters and adjust camera to that position.

4. Display current preset: move the cursor to **【SHOW PRESET】** , press **【OPEN】** , the screen will display the current preset;

5. Clear current preset: move the cursor to **【CLEAR PRESET】** , press **【OPEN】** , the current preset is cleared.

6. **【AUTO TRACKING】** : Call preset to Set auto-tracking ON/OFF; set as ON, call the current preset to open auto-tracking function; set as OFF, call the current preset to close auto-tracking function; Set as NONE, call the current preset has no effect in auto-tracking function.

7. Edit current preset label: move the cursor to **【EDIT PRESET LABEL】** , press **【OPEN】** to enter into editing preset submenu, system auto-sets label as PRESET-XX, press **【OPEN】** to revise label.

1. When running to program, display, clear preset and edit label, should choose preset number at first.

2. The label may set up to 16 characters, and doesn't need editing characters. Press **【OPEN】** continuously to jump over and use spacebar to replace the deleted characters. When you finish to edit a character, press **【OPEN】** to enter into the next editing character; when you finish to edit the last character, pressing **【OPEN】** to save. Press **【CLOSE】** to exit. Character of label is suitable for choosing as follow: 0-9, A-Z, & ? ! \* space.

3. As the submenu **【STATE】** in **【AUTO TRACKING】** is set as OFF, it is valid to Call preset to set auto-tracking ON/OFF. (Pls refer to the Paragraph 6.7)



**NOTICE**

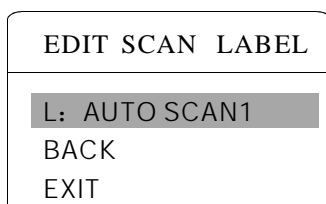
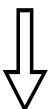
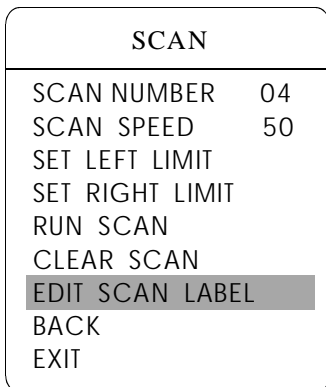
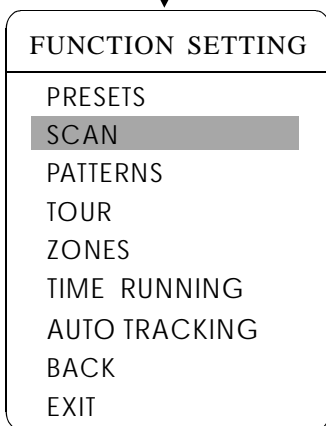
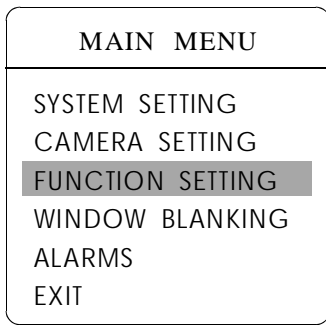

## 6.2 Scan

Scan is that pre-set two points, then the camera repeatedly scan between the two points at a stable speed, the same magnification and pan. Each dome has four scan tour.

1. The system enters into the main menu by calling 95 preset or by calling 9 preset twice within 3 seconds. Click menu to enter “scan” menu, as the left picture shows.

- **【SCAN NUMBER】**
- **【SCAN SPEED】**
- **【SET LEFT LIMIT】**
- **【SET RIGHT LIMIT】**
- **【RUN SCAN】**
- **【CLEAR SCAN】**
- **【EDIT SCAN LABEL】**

2. Define current scan number: operate joystick ,move the cursor to **【scan number】** , press **【open】** , tilt up/downjoystick to choose scan number, press **【open】** to save. The following operations aim at the current scan number.

3. Scan speed setting: operate joystick to **【SCAN SPEED】** , press **【OPEN】** , tilt up/down joystick to adjust scan speed, press **【OPEN】** to save.

4. Left limit setting: operate joystick to **【SET LEFT LIMIT】** , press **【OPEN】** operate joystick to choose objective image, press **【OPEN】** to save. Right limit setting is the same as left limit setting

5. Edit scan label: operate joystick, move the cursor to **【EDIT SCAN LABEL】** , press **【OPEN】** to enter submenu “edit label” , move the cursor to **【LABEL】** , the system will auto-set the label as AUTO SCAN, press **【OPEN】** to revise.



**NOTICE**

The label can set up to 16 characters, and doesn't need editing characters. Pressing **【OPEN】** continuously to jump over and using spacebar to replace the deleted characters. When you finish to edit a character, pressing **【OPEN】** to enter into the next editing character when you finish to edit the last character, pressing **【OPEN】** to save. Press **【CLOSE】** to exit.  
Character of label is suitable for choosing as follow: 0-9、A-Z、: <>-., Space. The editing ways of other labels are the same as above.

6. Run scan: operate joystick to **【RUN SCAN】** , press **【OPEN】** to exit the menu, and it starts to run scan.



**NOTICE**

1. Left limit and right limit of scan can't be set the same point.
2. Under scan process, speed, magnification and tilt direction won't change, if the speed, magnification and tilt direction of the two limits are inconsistent, run scan is base on left limit.

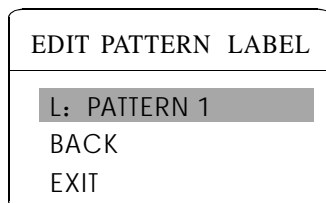
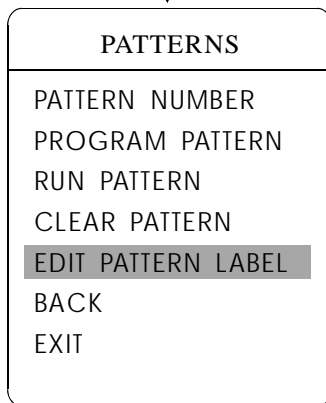
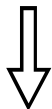
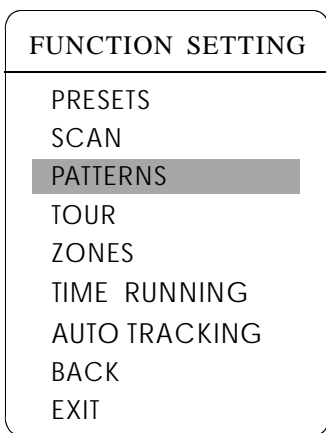
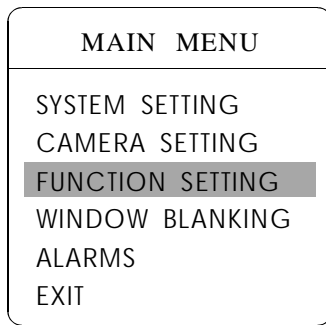

## 6.3 Pattern

Pattern is built-in function in camera; the speed dome can record tracks that are no less than 180s. (A series of pan/tilt controlling and lens controlling command). A dome may set up to 4 patterns.

1. The system enters into the main menu by calling 95 preset or by calling 9 preset twice within 3 seconds.
2. Operate joystick and move the cursor to **【FUNCTION SETTING】**, press **【OPEN】** to enter submenu.
3. Operate joystick to **【PATTERN】**, press **【OPEN】** to enter menu “Pattern”.
  - **【PATTERN NUMBER】**
  - **【PROGRAM PATTERN】**
  - **【RUN PATTERN】**
  - **【CLEAR PATTERN】**
  - **【EDIT PATTERN LABEL】**
4. Choose pattern number: move the cursor to **【PATTERN NUMBER】**, press **【OPEN】**, pattern you choose as current pattern, the following operations aim at the current pattern;
5. Define current pattern tour: move the cursor to **【PROGRAM PATTERN】**, press **【OPEN】** to set pattern track, move the image random, and draw the focus. The dome has a tour that is no less than 180s, a series of park time, magnification, focus will be recorded, press **【OPEN】** to save.
6. Run pattern: operate joystick to **【RUN PATTERN】**, press **【OPEN】** to run, the dome will continuously and repeatedly record the specific track.



When carry out program, run, clear pattern and edit label, should choose pattern number at first.

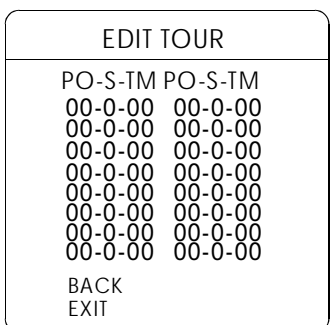
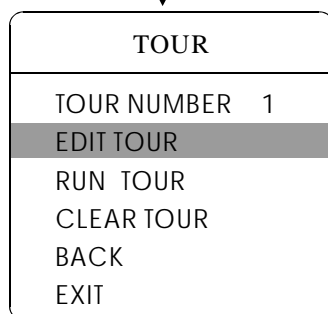
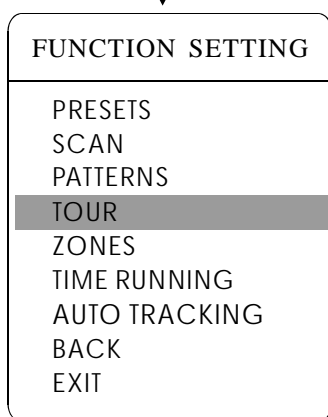
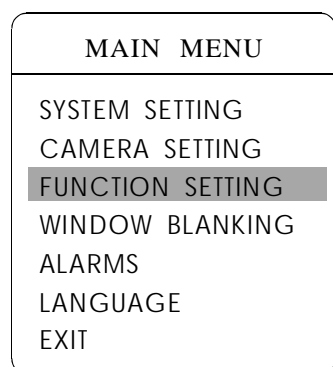

## 6.4 Tour

Tour is the built-in function in the speed dome, it will arrange the presets into the queue of auto-tour, and can set how long it will park at preset. Operate auto-tour is a process of incessantly transfer each preset. One tour can store 16 presets at most.

1. The system enters into the main menu by calling 95 preset or by calling 9 preset twice within 3 seconds.
2. Operate joystick and move the cursor to **【FUNCTION SETTING】**, press **【OPEN】** to enter submenu.
3. Operate joystick, move the cursor to **【TOUR】**, press **【OPEN】** to enter menu “tour” .
4. Set the park time of preset: Operate joystick and move the cursor to **【TOUR DWELL】**, press **【OPEN】**, there will be a sign “⚙” in the front of **【TOUR DWELL】**, the cursor jumps to right, tilt up/down to set park time, and the range is 000-255(s)
5. Set tour: move the cursor to **【EDIT TOUR】**, press **【OPEN】** to set tour interface, **【PO-S-TM】** set preset ,speed and time ,press **【OPEN】**, the first dwell is activated , tilt up/down joystick to choose preset number, the preset numerical value should be within 1-80 preset , a tour can set up to 24 presets. Press **【OPEN】**, the cursor jump to the next dwell ,tilt up/down joystick to choose current arrival preset speed , total 8 level of speed , increasingly from level 1 to level 8. Press **【OPEN】**, the cursor jumps to the next dwell , tilt up/down joystick to set current preset maintaining time, 60 seconds maximum . If set the presets of the second line ,move the cursor to the second line , press **【OPEN】** to continue edit .press **【OPEN】** to save after setting , press **【CLOSE】** to exit.
6. Run tour: Operate joystick, move the cursor to **【RUN TOUR】**, press **【OPEN】** to exit the menu, it starts to run tour.



**NOTICE**

The system will leap over the preset automatically when the stay time of one item setting up on 0. The dome will not run the tour of latter preset when preset or movement speed setting up on 0 .



# Function setting

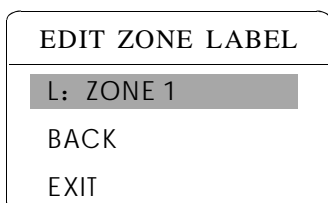
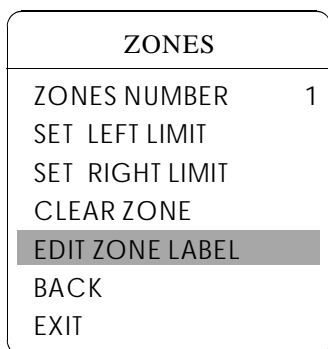
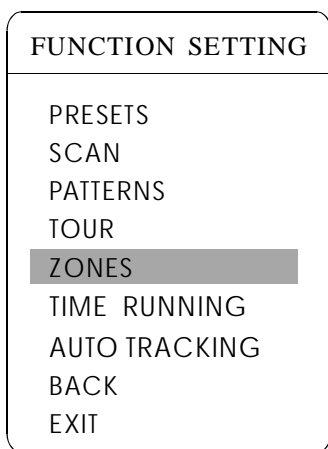
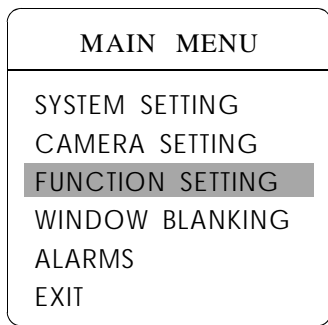

## 6.5 Zone

A dome may be set up to 8 zones, the regional scene can't be overlapped. User will set label for each zone. When setting **【ZONE LABEL】** as ON, the dome will display zone label as it runs some zone. It is convenient to know the zone that the camera shoots by setting zone label.

1. The system enters into the main menu by calling 95 preset or by calling 9 preset twice within 3 seconds.
2. Operate joystick and move the cursor to **【FUNCTION SETTING】**, press **【OPEN】** to enter submenu.
3. Operate joystick and move the cursor to **【ZONES】**, press **【OPEN】** to enter submenu, as the left picture shows.
  - **【ZONES NUMBER】**
  - **【SET LEFT LIMIT】**
  - **【SET RIGHT LIMIT】**
  - **【CLEAR ZONE】**
  - **【EDIT ZONE LABEL】**

Regard the left/right limit as the demarcation line, and set the middle part as a zone. Various operational ways are the same as other settings in the menu. Therefore we don't explain it again.

<b>MAIN MENU</b>
SYSTEM SETTING
CAMERA SETTING
<b>FUNCTION SETTING</b>
WINDOW BLANKING
ALARMS
EXIT



<b>FUNCTION SETTING</b>
PRESETS
SCAN
PATTERNS
TOUR
ZONES
<b>TIME RUNNING</b>
AUTO TRACKING
BACK
EXIT

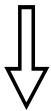

<b>TIME RUNNING</b>	
DAY	SAT
TIME CHANNEL	1
START TIME	00:00
END TIME	00:00
RUNNING	TOUR1
BACK	
EXIT	

## 6.6 Time running

User can set the time of preset, scan, tour and pattern.

1. Call 95 preset or call 9 preset twice within 3 seconds to enter into the main menu.
2. Operate the joystick and move the cursor to **【FUNCTION SETTING】** , press **【OPEN】** to call the submenu.
3. Operate the joystick and move the cursor to **【TIME RUNNING】** , press **【OPEN】** to enter into the menu setting. Please refer to the left picture.
  - **【DAY】** set the date
  - **【TIME CHANNEL】** 4 channels can be set.
  - **【START TIME】** Set the start time
  - **【END TIME】** Set the end time
  - **【RUNNING】** User can set the preset , scan , tour, pattern to every channel(1-4).
  - **【TRK-A1】** : When speed dome run “TOUR” in this time, it will auto-open auto-tracking and AUX1 if discovering moving objection.
4. This channel will not conflict with other channels when you set **【RUNNING】** as close.



### NOTICE

1. When user run the action of scan, tour or pattern, if time is over, then the Dome will execute park action, the user's action will stop. After the time, the dome will resume the action and preset which is set before the park time. (Before the park time, if the dome is on some preset, the dome will resume the preset, if domes execute the action of scanning, tour or pattern, the dome will resume original action. If users handle some action with keyboard, dome will also resume the action which users are going on with keyboard.)

2. During the timing period of movement function, it is not allowed that there is no action. When users handle the dome, the timing movement function will interrupt. If there is no any action during 10 seconds, it will be in the state of timing function, and return to the timing movement function. Or if there is idle function, it will do the action of idle time function.

3. Timing function will close while user setting presets, right and left limit, menu status, recording scan and setting any other function.

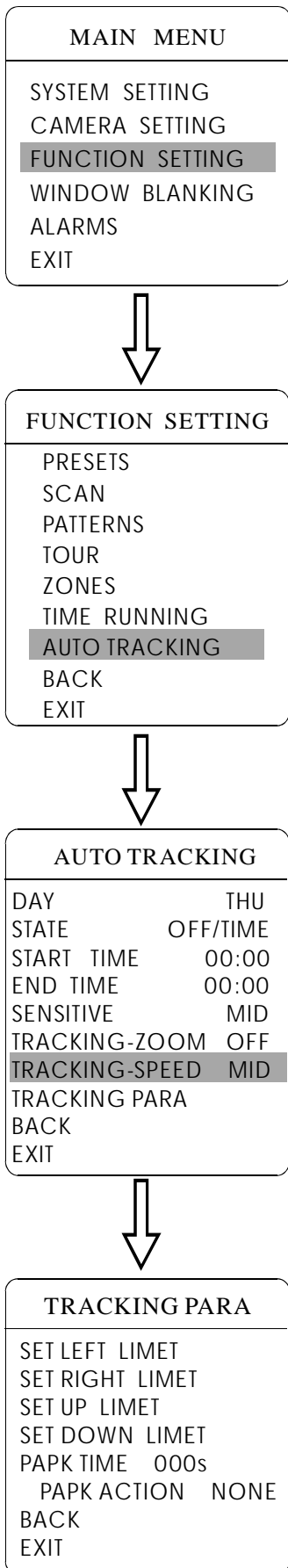

## 6.7 Set auto-tracking

When initiate Auto tracking function, the speed dome automatically captures the picture of the moving object, thus real-timely tracking.

1. Call 95 preset or call 9 preset twice within 3 seconds, input password to enter the main menu.

2. Operate the joystick to move the cursor to **【FUNCTION SETTING】**, press **【OPEN】** to enter the next menu.

3. Operate the joystick to move the cursor to **【AUTO TRACKING】**, press **【OPEN】** to enter the next menu, as showed on the left picture.

4. Set left limit of the motion detection area: operate the joystick to **【SET LEFT LIMIT】**, press **【OPEN】**, operate joystick to the target position, then press **【OPEN】** to save. Set right limit of the motion detection area: operate the joystick to **【SET RIGHT LIMIT】**, press **【OPEN】**, operate joystick to the target position, then press **【OPEN】** to save. When the left & right limit is set at the same point, the speed dome will track the moving object with pan 360° area.

5. Set upper limit of the motion detection area: operate the joystick to **【SET UPLIMIT】**, press **【OPEN】**, operate joystick to the target position, then press **【OPEN】** to save. Set down limit of the motion detection area: operate the joystick to **【SET DOWN LIMIT】**, press **【OPEN】**, operate joystick to the target position, then press **【OPEN】** to save. When the up & down limit is set at the same point, the speed dome will track the moving object within tilt 360° area.

6. **【PARK TIME】** The setting allows PTZ to execute the next designated action after it is in idle state (for 1-240 seconds) on condition that it is under the “Auto Tracking” Mode. The default setting is 000, which means no action.

A) Under the “Auto Tracking” Mode.

b) TRACKING PARA → PARK TIME, which setting is not “0”

c) TRACKING PARA → PARK TIME, which setting is not “none”

When reaching the above 3 conditions at the same time:

It will execute the function under **【TRACKING PARA → PARK TIME 000S PARK ACTION NONE】**, but it won't execute the function under **【MOTION → PARK TIME 000 PARK ACTION NONE】**. When can't reach the above 3 conditions at the same time: It will execute the function under **【MOTION → PARK TIME 000 PARK ACTION NONE】**, but but it won't execute the function under **【TRACKING PARA → PARK TIME 000S PARK ACTION NONE】**

Call 250 preset to set the Auto Tracking function ON. Call 251 preset to set the Auto Tracking function OFF. The speed dome will not resume keeping the Auto Tracking function when it power on.



**NOTICE**

The speed dome will track the moving object at random when there are too many objects in tracking area. Too light or too dark will influence the effect of auto tracking.

The function relates to the speed dome and build-in camera modules; the item will not be showed or “N/A” when the camera doesn't have such function.

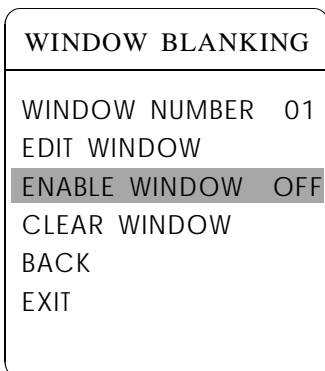
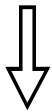
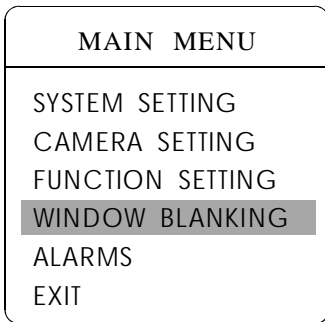

## 7. Privacy zone masking

Privacy function can show someone piece of regional shielding while protecting. For example, protect the window of bedroom or ATM of bank. A dome can set up to 24 privacy windows.(Privacy zone mask function is relative with the model of camera module. The masking numbers will be different according to the different cameras.)

**Hitachi Camera:** It can be set 8 masking zone at most in 360° surveillance range,can set 2 masking at most per screen. The screen will note " please move " when the position can not be set. It can not set masking when the dome rotates down in the level  $\geq 45^\circ$  .

**Sony Camera:** It can be set 24 masking zone at most in 360° surveillance range. ( Sony 45 series can be set 8 masking at most ). It can not set masking zone when the dome rotates down in the level  $\geq 20^\circ$  . LG,CNB Camera module do not have masking function.

1. The system enters into the main menu by calling 95 preset or by calling 9 preset twice within 3 seconds.

2. Operate joystick to **【WINDOW BLANKING】** , press **【OPEN】** to enter menu “ window blanking ” .

- **【WINDOW NUMBER】** choose window number as current privacy window, other choices in the menu just aim at current privacy window;

- **【EDIT WINDOW】** program current window;

- **【ENABLE WINDOW】** permit/prohibit current privacy window, there are two choices: ON---permit current privacy window/OFF---prohibit current privacy window

- **【CLEAR WINDOW】** clear current privacy window, after clearing it, the window will auto- change as OFF.

3. Program current privacy window: Firstly choose window number, then do the following operations:

a. Operate joystick, move the cursor to **【EDIT WINDOW】** , press **【OPEN】** to move the image that need privacy window to display in the screen.

b. Press **【OPEN】** , there will be a square displaying in the center of the screen, operate joystick, and move the square to the central place that need to conceal.

c. Press **【OPEN】** , operate joystick to adjust the size of privacy zone: joystick up, the height is increased; joystick down, the height is reduced; joystick to right, the width is increased; joystick to left, the width is reduced.

d. Press **【OPEN】** to save the current privacy zone setting, and the window will auto-change as ON at the same time.

Privacy zone masking



**NOTICE**

This function is decide by the parameter of built-in camera, if the camera does not have this function, this option is invalid.

MAIN MENU	
SYSTEM SETTING	
CAMERA SETTING	
FUNCTION SETTING	
WINDOW BLANKING	
<b>ALARMS</b>	
EXIT	

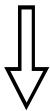

ALARMS	
RESUME	OFF
SEQUENCE	002
RESET DELAY	020
ALARM CONTACT	N/C
<b>ALARM SETTING</b>	
ARM SETTING	
BACK	
EXIT	



ALARM SETTING	
NUMBER	01
<b>ACTION</b>	<b>TOUR</b>
ACTIVATE AUX	NONE
PRIORITY	HIGH
BACK	
EXIT	

## 8. Alarm function

Speed dome may connect with 7 alarm input, 2 alarm output, and support alarm linkage. The external alarm message sends to the dome, then the dome sends to alarm point shoot (to call preset, auto scan, auto cruise and auto pattern), and choose that to run alarm output or not.

1. The system enters into the main menu by calling 95 preset or by calling 9 preset twice within 3 seconds. Click each menu according to the left picture, then enter menu alarm, choices as follow:

- **【RESUME】** resume mode after relieving alarm input, there are two choices: ON---clear alarm output, the dome will stop.  
OFF---just clear alarm output.
- **【RESET DELAY】** set alarm reset and delay the time (1-225s), how long to relieve and run **【RESUME】** after the dome receives alarm message.
- **【ALARM CONTACT】** set state of the relay. N/C---often close the state, N/O---often hold the state. If setting as often closing the state, the relay is in closing the state when there is no alarm to output; when there is alarm to output, the relay is in holding the state.
- **【ALARM SETTING】**
- **【ARM SETTING】**

2. Operate joystick and move the cursor to **【ALARM SETTING】**, press **【OPEN】** to enter the menu alarm setting

- **【ALARM NUMBER】** alarm number is corresponding with 12 bits plug in the external switching board of the dome(as below shows). 001 priority is the highest, 004 priority is the lowest. The two lines alarm input at the same time, the dome run alarm that the highest priority.
- **【ALARM ACTION】** as current alarm input, to run the action. Choices for choosing as follow. NONE---none action/SCAN/PAT X---run a pattern tour /TOUR---run tour/PRESET---call preset, when the dome number is set as 1, to call preset 1; when the dome number is set as 2, to call preset2.
- **【ACTIVATE AUX】** as current alarm input, to run alarm output or not. NONE---none alarm output/AUX 1---the first alarm output/AUX 1---the secondary alarm output/BOTH--- two alarms output.
- **【ALARM PRIORITY】** alarm priority can be defined as three grades: high, middle, low.

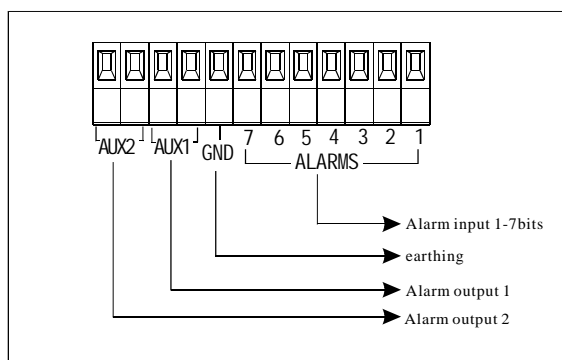

MAIN MENU	
SYSTEM SETTING	
CAMERA SETTING	
FUNCTION SETTING	
WINDOW BLANKING	
<b>ALARMS</b>	
EXIT	

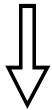

ALARMS	
RESUME	OFF
SEQUENCE	002
RESET DELAY	020
ALARM CONTACT	N/C
ALARM SETTING	
<b>ARM SETTING</b>	
BACK	
EXIT	

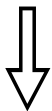

ARM SETTING	
DAY	SUN
<b>ARM STATE</b>	<b>OFF</b>
ARM TIME	N/A
UNARM TIME	N/A
BACK	
EXIT	

## 8.1 ARM Setting

1. Call 95 preset or call 9 preset twice within 3 seconds and then input the password to enter the main menu.

2. Operate the joystick up and down, move the cursor to **【ALARMS】**, press **【OPEN】** to call the submenu.

3. Operate the joystick up and down, move the cursor to **【ARM SETTING】**, press **【OPEN】** to call the submenu. Please refer to the left picture.

4. Operate the joystick up and down, move the cursor to **【DAY】**, Press **【OPEN】** to choose it, Operate the joystick up and down to set date, set the date according to the week. To set the Alarm state and Alarm date based on the time.

- **【ARM STATE】** Alarm off /Alarm on (Alarm Setting is noneffective under Alarm off. Alarm Setting is effective under Alarm on)
- **【ARM TIME】** : User can set the alarm time.
- **【UNARM TIME】** : User can set the alarm off time.
- **【BACK】** : back to the former menu.
- **【EXIT】** : Exit the menu.

## 9.1 Menu Index

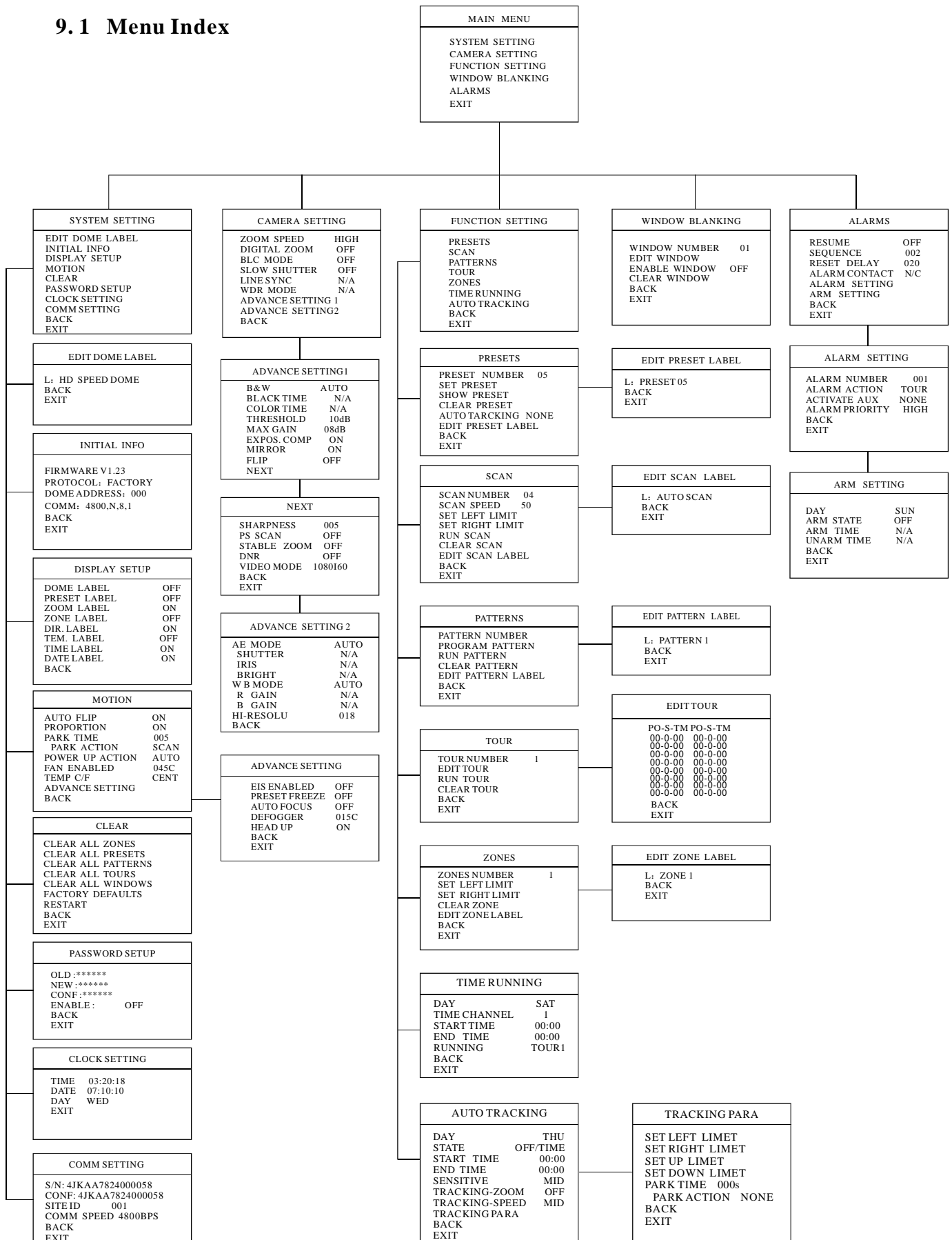

## 9.2 Trouble shooting

Trouble	Possible causes	Solution
No self-testing, no video after power up	Power supply is damage or power consumption is not enough	Replace
	Power line is bad connection	Correct
	Engineering line is malfunction	Check and repair
Self-testing and image are normal but the dome is uncontrollable	The dome DIP switch setting is incorrect	Refer to switch setting, reset the switch
	RS485 may carve out a way	Check Rs485 connection, confirm the connection is correct and good in contact
	RS485 is in malfunction	Pls consult appendix “Rs485 Bus acknowledge”
Video image is not steady.	Video line is bad connection	Eliminate
	Power consumption is not enough	Replace right power adapter, it is better to put the switch and power adapter near the dome
Video image is not steady and the motor is malfunction	Power consumption is not enough	Replace the power
Dome controlling is not smooth.	Controlling line is bad connection Rs485 loads so many or the distance of communication is much far	1. Connect 120Ω resistance in the dome pan/tilt that is far from the controller 2. Increase distributor

## 9.3 The cleaning of clear down cover

- To obtain constant clear videos, user should clean the down cover periodically.
- Be caution when cleaning, hold the down cover ring only to avoid direct touch to the acrylic down cover. The acid sweat mark of fingerprint will corrode the coating of down cover and scratch on down cover will cause vague image.
- Use soft dry cloth or the substitute to clean the inner and outer surfaces
- For hand contamination, use neutral detergent. Any cleanser for high grade furniture is applicable.





## 9.4 RS485 Bus basic knowledge

### Ø Characteristics of Rs485 Bus

As specified by Rs485 standard, Rs485 Bus is of half-duplexed data transmission cables with characteristic impedance as  $120\Omega$ . The maximum load capacity is 32unit loads(including main controller and controller equipment)

### Ø Transmission distances of RS485 Bus

When user selects the 0.56mm(24AWG) twisted pair wires as data transmission cable, the maximum theoretical transmitting distance as follow:

Baud rate	Max distance
2400BPS	1800m
4800BPS	1200m
9600BPS	800m
19200BPS	600m

If user selects thinner cables, or installs the dome in an environment with strong electromagnetic interference, or connects lots of equipment to the Rs485Bus, the maximum transmitting distance will be decreased. To increase the maximum transmitting distance, do the contrary.

### Ø RS485Bus troubles shooting

Trouble	Possible cause	Solution
Dome can do self-testing but cannot be controlled	<ol style="list-style-type: none"> <li>1. The address and baud rate setting of dome are not in conformity with those of controller.</li> <li>2. The + and - connection of RS485 Bus is incorrect</li> <li>3. bad connection</li> <li>4. There are circuit in the Rs485Bus</li> </ol>	<ol style="list-style-type: none"> <li>1. Change the address and baud rate of controller or dome</li> <li>2. Adjust the + and -connection of Rs485;</li> <li>3. Make sure the connections are fully seated;</li> <li>4. Change Rs485 Bus wires</li> </ol>
The dome can be controlled but the operation is not smooth	<ol style="list-style-type: none"> <li>1. The Rs485Bus is not in good contact with the connectors</li> <li>2. One wire of Rs485bus is broken</li> <li>3. The dome is very far from controller</li> <li>4. There are too many domes connected in the system</li> </ol>	<ol style="list-style-type: none"> <li>1. Secure the connection;</li> <li>2. Replace Rs485 bus wires</li> <li>3. Add termination resistors to the system</li> <li>4. Install Rs485 distributor</li> </ol>

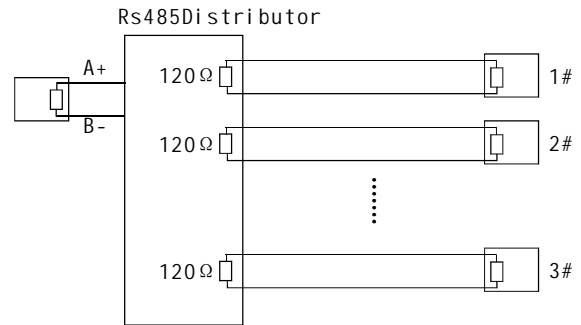

In such circumstances the Factory recommends the usages of Rs485 distributor. The distributor can change the star configuration connection to the mode of connection stipulated in the Rs485 standards. The new connection achieves reliable data transmission. (Refer to picture 11.4-5)



Picture 11.4-5

## 10. Installation instruction

### Ø Figure corresponding sheet

Model	Picture
Ceiling mount	
Wall mount	

### Ø Details of relevant parts

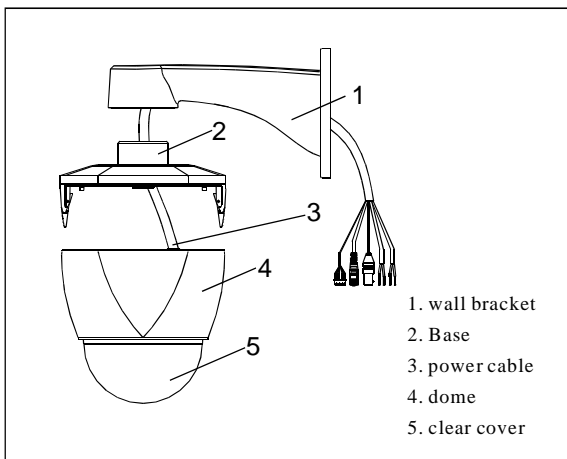

## 1. Ceiling mount Installation instruction

### 1.1 Dimension of product

As picture below:

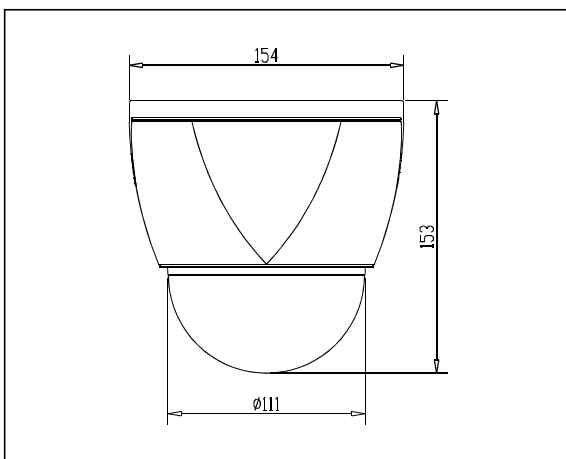

Picture 1.1-1

### 1.2 Installation of product

1. Drill holes and fix base board on the ceiling floor by using four ST3.5 bolts. (As picture 1.2-1)

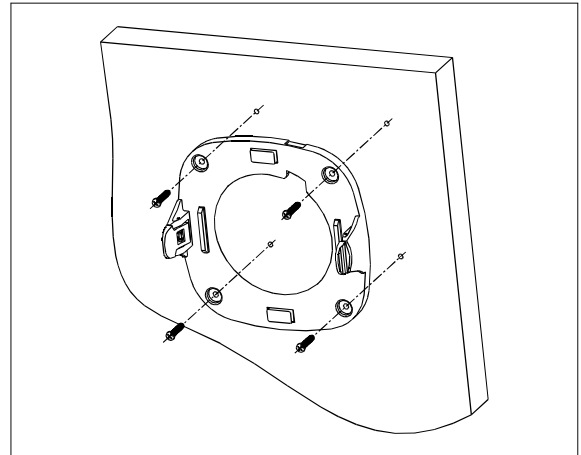

Picture 1.2-1

2. Through the cable from the top of the base, and fix the four bolt then push the dome up. Pull out the cable from the top (As picture 1.2-2).

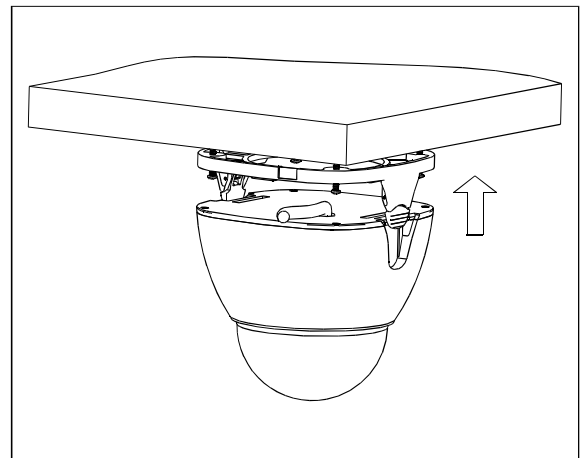

Picture 1.2-2

3. Connect the power cable, video cable and Rs485 control cable. (Don't need to connect network cable if it is not IP dome.) (As picture 1.2-3)

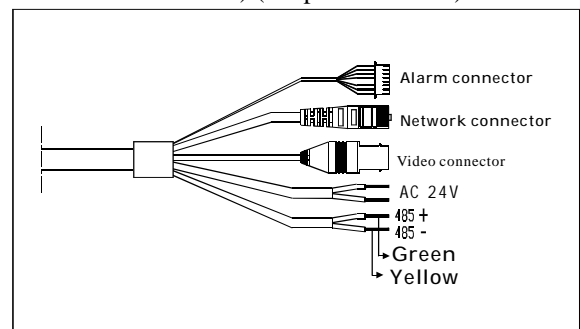

Picture 1.2-3

## 2. Wall mount installation instruction

### 2.1 Dimension of product

As picture below:

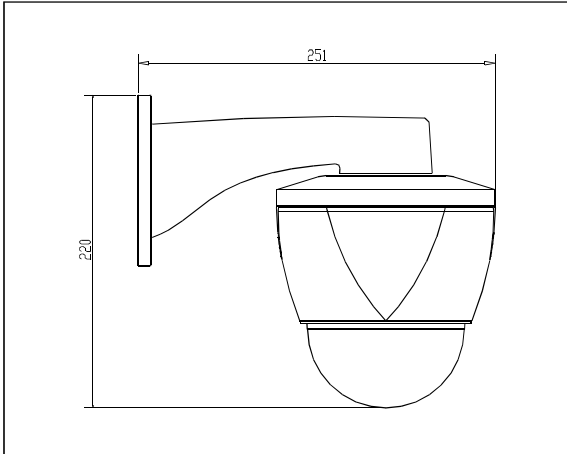

Picture 2.1

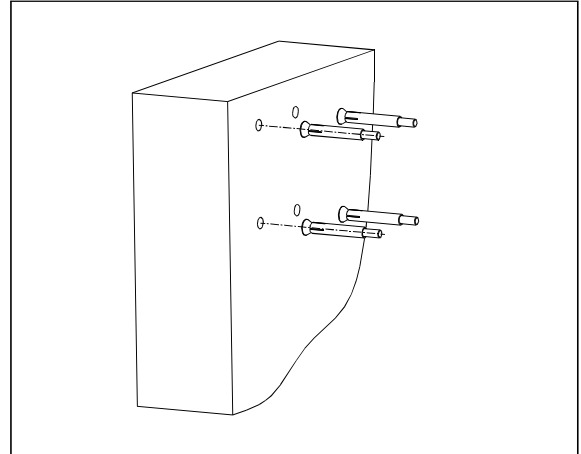

Picture 2.2-2

3. Pls make the wall bracket aims at the M8 screw, so that the output cable will be locked in the hole of motherboard bracket, and use the M8 screw to lock the wall bracket tightly. (As picture 2.2-3)

### 2.2 Installation of product

1. Make the wall bracket as the model on installation wall, and draw the central position of the drill hole. (As picture 2.2-1)

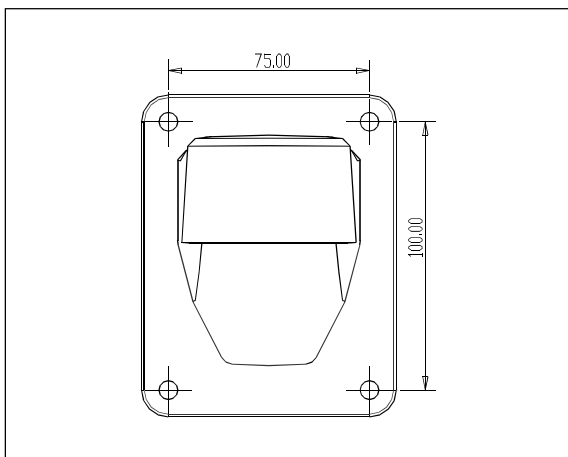

Picture 2.2-1

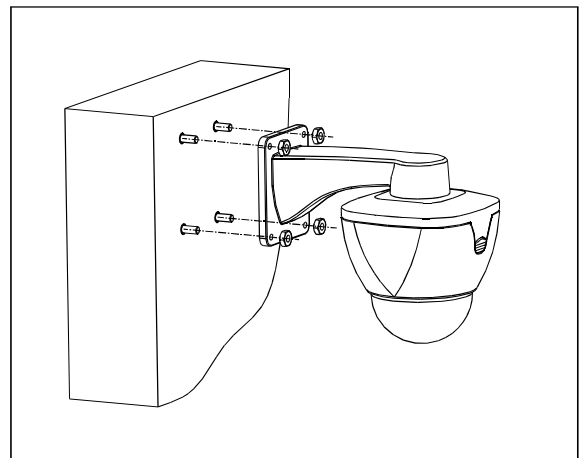

Picture 2.2-3

4. Connect the power cable, video cable and RS485 control cable. (Don't need to connect network cable if it is not IP dome.) (As picture 1.2-3)

2. Drill four installation holes for M8 metal expand screw with the lashed electric drill on the installation surface, and be sure with the installation hole of 75mm depth approximately and M8 expand metal screw. (As picture 2.2-2)

## **11. Maintenance service terms**

### **1. Range of warranty**

- The product will be maintained free for one year.
- The product will be obtained the free maintenance service if the same malfunction appears again within three months.
- Malfunction of products caused by force majeure (such as war, earthquake, lightning strike and so on), abuse, non-standard operation, change of construction, non-normal wear or accident are non-free of warranty.
- Please prevent from the damage which is caused by heavy pressure, the fierce vibration and soaks in the process of transportation and storage, which does not belong to the free maintenance scope.
- Please adopt the way of fission package or original package to transport because the product damage does not belong to the free maintenance scope if you use the whole packing way, not the original packing way.
- The maintenance services will not be free when the pan/tilt module is disassembled or serviced by the user voluntarily.
- Our company implements the lifetime payable service if the product in malfunction has surpassed the warranty period.
- To the products with defect :if it's in the period of warranty, please fill in the form of warranty information correctly, describe the trouble in details, and provide original sales invoice or its copy.
- For the damage and loss which was caused by the user's specifically application, factory won't bear any risk and responsibility. The factory compensation made by breach of faith, negligence or tortious won't exceed the amount of the products. The factory won't bear any responsibility for the special, unexpected and continue damage caused by any other reasons.
- Our company has the final right of explanation for the above terms.

### **2. Warranty terms**

- If the products are within the warranty time, the buyer should fill in the warranty card and send back together with the products.

### **3. Shipping**

- If the product needs repaired, you can return it to the manufacturer through the supplier or directly. If you choose the later, please contact us in order to speed up the process. And our company only undertake the one-way freight from manufacturer to customer after maintenance.