

# Preface

## Copyright

This publication, including all photographs, illustrations and software, is protected under international copyright laws, with all rights reserved. Neither this manual, nor any of the material contained herein, may be reproduced without written consent of the author.

Version 7.0

## Disclaimer

The information in this document is subject to change without notice. The manufacturer makes no representations or warranties with respect to the contents hereof and specifically disclaims any implied warranties of merchantability or fitness for any particular purpose. The manufacturer reserves the right to revise this publication and to make changes from time to time in the content hereof without obligation of the manufacturer to notify any person of such revision or changes.

## Trademark Recognition

Microsoft, MS-DOS and Windows are registered trademarks of Microsoft Corp.

MMX, Pentium, Pentium-II, Pentium-III, Celeron are registered trademarks of Intel Corporation.

Other product names used in this manual are the properties of their respective owners and are acknowledged.

## Federal Communications Commission (FCC)

This equipment has been tested and found to comply with the limits for a Class B digital device, pursuant to Part 15 of the FCC Rules. These limits are designed to provide reasonable protection against harmful interference in a residential installation. This equipment generates, uses, and can radiate radio frequency energy and, if not installed and used in accordance with the instructions, may cause harmful interference to radio communications. However, there is no guarantee that interference will not occur in a particular installation. If this equipment does cause harmful interference to radio or television reception, which can be determined by turning the equipment off and on, the user is encouraged to try to correct the interference by one or more of the following measures:

- Reorient or relocate the receiving antenna
- Increase the separation between the equipment and the receiver
- Connect the equipment onto an outlet on a circuit different from that to which the receiver is connected
- Consult the dealer or an experienced radio/TV technician for help

Shielded interconnect cables and a shielded AC power cable must be employed with this equipment to ensure compliance with the pertinent RF emission limits governing this device. Changes or modifications not expressly approved by the system's manufacturer could void the user's authority to operate the equipment.

## Preface

## Declaration of Conformity

This device complies with part 15 of the FCC rules. Operation is subject to the following conditions:

- This device may not cause harmful interference, and
- This device must accept any interference received, including interference that may cause undesired operation





## Canadian Department of Communications

This class B digital apparatus meets all requirements of the Canadian Interference-causing Equipment Regulations.

Cet appareil numérique de la classe B respecte toutes les exigences du Règlement sur le matériel brouilleur du Canada.

## About the Manual

The manual consists of the following:

<b>Chapter 1</b> <b>Introducing the Motherboard</b>	Describes features of the motherboard. Go to  page 1
<b>Chapter 2</b> <b>Installing the Motherboard</b>	Describes installation of motherboard components. Go to  page 7
<b>Chapter 3</b> <b>Using BIOS</b>	Provides information on using the BIOS Setup Utility. Go to  page 25
<b>Chapter 4</b> <b>Using the Motherboard Software</b>	Describes the motherboard software Go to  page 43
<b>Chapter 5</b> <b>Trouble Shooting</b>	Provides basic troubleshooting tips Go to  page 47

## Preface

## **TABLE OF CONTENTS**

---



---

Preface	i
<b>Chapter 1</b>	<b>1</b>
<b>Introducing the Motherboard</b>	<b>1</b>
Introduction.....	1
Feature.....	2
Motherboard Components.....	4
<b>Chapter 2</b>	<b>7</b>
<b>Installing the Motherboard</b>	<b>7</b>
Safety Precautions.....	7
Choosing a Computer Case.....	7
Installing the Motherboard in a Case.....	7
Checking Jumper Settings.....	8
<i>Setting Jumpers.....</i>	<i>8</i>
<i>Checking Jumper Settings.....</i>	<i>9</i>
<i>Jumper Settings.....</i>	<i>9</i>
Installing Hardware.....	10
<i>Installing the Processor.....</i>	<i>10</i>
<i>Installing Memory Modules.....</i>	<i>12</i>
<i>Expansion Slots.....</i>	<i>14</i>
<i>Connecting Optional Devices.....</i>	<i>16</i>
<i>Installing a Hard Disk Drive/CD-ROM/SATA Hard Drive...18</i>	<i>18</i>
<i>Installing a Floppy Diskette Drive.....</i>	<i>19</i>
Connecting I/O Devices.....	20
Connecting Case Components.....	21
<i>Front Panel Header.....</i>	<i>23</i>
<b>Chapter 3</b>	<b>25</b>
<b>Using BIOS</b>	<b>25</b>
About the Setup Utility.....	25
<i>The Standard Configuration.....</i>	<i>25</i>
<i>Entering the Setup Utility.....</i>	<i>25</i>
<i>Resetting the Default CMOS Values.....</i>	<i>26</i>
Using BIOS.....	27
<i>Standard CMOS Setup.....</i>	<i>28</i>
<i>Advanced Setup.....</i>	<i>30</i>
<i>Advanced Chipset Setup.....</i>	<i>33</i>

<i>Integrated Peripherals</i> .....	34
<i>Power Management Setup</i> .....	35
<i>PCI/PnP Setup</i> .....	37
<i>PC Health Status</i> .....	37
<i>Frequency/Voltage Control</i> .....	40
<i>Load Default Settings</i> .....	41
<i>Supervisor Password</i> .....	41
<i>User Password</i> .....	41
<i>Save &amp; Exit Setup</i> .....	42
<i>Exit Without Saving</i> .....	42
<i>Updating the BIOS</i> .....	42
<b>Chapter 4</b>	<b>43</b>
<b>Using the Motherboard Software</b>	<b>43</b>
About the Software DVD-ROM/CD-ROM.....	43
Auto-installing under Windows XP/Vista/7.....	43
<i>Running Setup</i> .....	44
Manual Installation.....	46
Utility Software Reference.....	46
<b>Chapter 5</b>	<b>47</b>
<b>Trouble Shooting</b>	<b>47</b>
Start up problems during assembly.....	47
Start up problems after prolong use.....	48
Maintenance and care tips.....	48
Basic Troubleshooting Flowchart.....	49

## Chapter 1

### *Introducing the Motherboard*

---

#### **Introduction**

Thank you for choosing the G31T-M7 motherboard. This motherboard is a high performance, enhanced function motherboard designed to support the LGA775 socket Intel® Yorkfield/Wolfdale/Core™ 2 Quad (Q6600/Q6700 G0)/Pentium® Dual-Core/Celeron® 4xx Series processors for high-end business or personal desktop markets.

The motherboard incorporates the G31 Northbridge (NB) and ICH7 Southbridge (SB) chipsets. The Northbridge supports a Front Side Bus (FSB) frequency of 1333/1066/800 MHz using a scalable FSB Vcc\_CPU. The memory controller supports DDR2 memory DIMM frequencies of 800/667. It supports two DDR2 sockets with up to maximum memory of 4 GB. DDR2 Maximum memory bandwidth of 12.8 GB/s in dual-channel symmetric mode assuming DDR2 800 MHz. High resolution graphics via one PCI Express slot, intended for Graphics Interface, is fully compliant to the PCI Express Base Specification revision 1.1.

The ICH7 Southbridge supports two PCI slots which are PCI 2.3 compliant. In addition, one PCI Express x1 slot is supported, fully compliant to the PCI Express Base Specification revision 1.1. It implements an EHCI compliant interface that provides 480 Mb/s bandwidth for eight USB 2.0 ports (four USB ports and two USB 2.0 headers support additional four USB ports). One onboard IDE connector supports two IDE devices in Ultra ATA100/66/33 mode. The Southbridge integrates a Serial ATA host controller, supporting four SATA ports with maximum transfer rate up to 3.0 Gb/s each.

The motherboard is equipped with advanced full set of I/O ports in the rear panel, including PS/2 mouse and keyboard connectors, COM, VGA port, LPT, four USB ports, one LAN port, and audio jacks for microphone, line-in and line-out.

## Feature

### Processor

The motherboard uses an LGA775 type of Intel® Yorkfield/Wolfdale/Core™ 2 Quad (Q6600/Q6700 G0)/Pentium® Dual-Core/Celeron® 4xx Series that carries the following features:

- Accommodates Intel® Yorkfield/Wolfdale/Core™ 2 Quad (Q6600/Q6700 G0)/Pentium® Dual-Core/Celeron® 4xx Series processors
- Supports a system bus (FSB) of 1333/1066/800 MHz
- Supports “Hyper-Threading” technology CPU

“Hyper-Threading” technology enables the operating system into thinking it’s hooked up to two processors, allowing two threads to be run in parallel, both on separate “logical” processors within the same physical processor.

### Chipset

The G31 Northbridge (NB) and ICH7 Southbridge (SB) chipsets are based on an innovative and scalable architecture with proven reliability and performance.

- G31 (NB)**
  - Supports 36-bit host bus addressing, allowing the CPU to access the entire 64 GB of the memory address space
  - 2 GB/s point-to-point Direct Media Interface (DMI) to ICH7 (1 GB/s each direction)
  - Supports 512 Mb and 1 Gb DDR2 DRAM technologies for x8 and x16 devices
  - One, 16-lane PCI Express port intended for Graphics Attach, compatible to the PCI Express® Base Specification revision 1.1
- ICH7 (SB)**
  - Enhanced DMA Controller, interrupt controller, and timer functions
  - Compliant with PCI Express Base Specification, Revision 1.1
  - Compliant with PCI 2.3 specification
  - Integrated SATA 3.0 Gb/s Host Controller
  - Integrated USB 2.0 Host Controller supporting up to eight USB 2.0 ports
  - Integrated IDE controller supports Ultra ATA 100/66/33

### Memory

- Supports DDR2 800/667 DDR SDRAM with Dual-channel architecture
- Accommodates two unbuffered DIMMs
- Up to 2 GB per DIMM with maximum memory size up to 4 GB

### Onboard LAN (optional)

The onboard LAN controller provides either of the following features:

- |  |
|--|
| <ul style="list-style-type: none"> <li>• Supports 10/100 Mbps Ethernet Transceiver</li> <li>• Fully compliant with IEEE802.3, IEEE802.3u, IEEE802.3ab</li> <li>• Wake-On-LAN(WOL) by Magic Packet/Frame/Link Change</li> </ul>               |
| <ul style="list-style-type: none"> <li>• Integrated PHY for 10/100/1000 Mbps</li> <li>• IEEE 802.3x compliant flow control support</li> <li>• Three power supplies: 2.5V, 1.8V and 1.2V</li> <li>• PCI Express base 1.1 compliant</li> </ul> |

## Introducing the Motherboard

## Audio (optional)

This motherboard may support either of the following Audio chipsets:

<ul style="list-style-type: none"> <li>• 5.1 Channel High Definition Audio Codec</li> <li>• ADCs support 44.1K/48K/96KHz sample rate</li> <li>• Meet Microsoft WLP 3.08 Vista premium and mobile PCs audio requirements</li> <li>• Direct Sound 3D™ compatible</li> </ul>
<ul style="list-style-type: none"> <li>• 5.1 Channel High Definition Audio Codec</li> <li>• Exceeds Microsoft Windows Logo Program (WLP) Requirements</li> <li>• ADCs support 44.1K/48K/96K/192KHz sample rate</li> <li>• Power Support: Digital: 3.3V; Analog: 5.0V</li> </ul>

## Expansion Options

The motherboard comes with the following expansion options:

- One PCI Express slot for Graphic Interface
- One PCI Express x1 Slot
- Two 32-bit PCI v2.3 compliant slots
- One IDE connector that supports two IDE devices
- One floppy disk drive interface
- Four 7-pin SATA connectors

## Integrated I/O

The motherboard has a full set of I/O ports and connectors:

- Two PS/2 ports for mouse and keyboard
- One serial port
- One parallel port
- One VGA port
- Four USB ports
- One LAN port
- Audio jacks for microphone, line-in and line-out

## BIOS Firmware

This motherboard uses AMI BIOS that enables users to configure many system features including the following:

- Power management
- Wake-up alarms
- CPU parameters
- CPU and memory timing

The firmware can also be used to set parameters for different processor clock speeds.



*1. Some hardware specifications and software items are subject to change without prior notice.*

*2. Due to chipset limitation, we recommend that motherboard be operated in the ambience between 0 and 50° C.*

## Introducing the Motherboard

## Motherboard Components

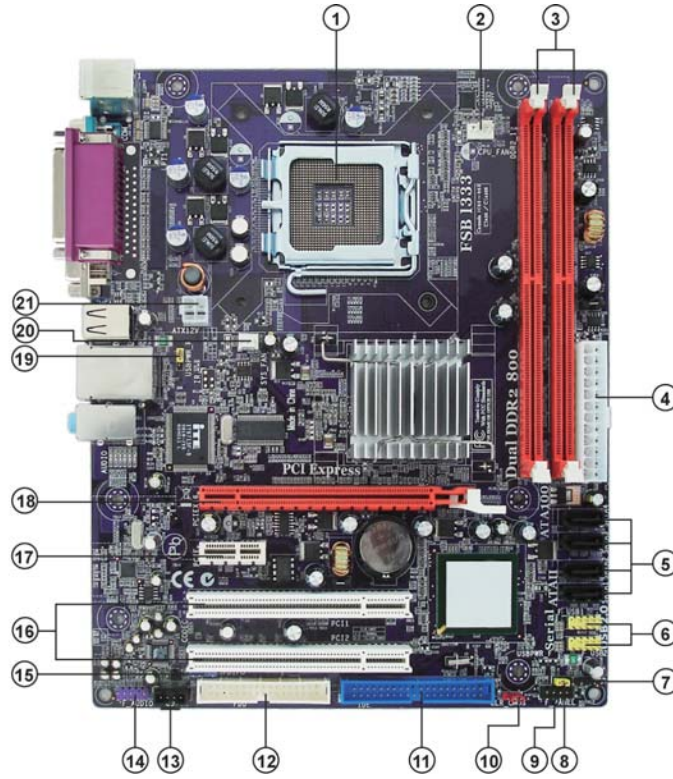

## Introducing the Motherboard



**Table of Motherboard Components**

LABEL	COMPONENTS
1. CPU Socket	LGA775 socket for Intel® Yorkfield/Wolfdale/Core™ 2 Quad (Q6600/Q6700 G0)/Pentium® Dual-Core/Celeron® 4xx Series processors
2. CPU_FAN	CPU cooling fan connector
3. DDR2_1~2	240-pin DDR2 SDRAM slots
4. ATX_POWER	Standard 24-pin ATX power connector
5. SATA1~4	Serial ATA connectors
6. F_USB1~2	Front Panel USB headers
7. SPK	Speaker header
8. USBPWR_F	Front Panel USB Power Select Jumper
9. F_PANEL	Front panel switch/LED header
10. CLR_CMOS	Clear CMOS jumper
11. IDE	Primary IDE channel
12. FDD	Floppy disk drive connector
13. CD_IN	Analog audio input connector
14. F_AUDIO	Front panel audio header
15. SPDIF0	SPDIF out header
16. PCI1~2	32-bit add-on card slots
17. PCIE	PCI Express x1 slot
18. PCIEX16	PCI Express x16 graphics card slot
19. USBPWR_R	Rear Panel USB PS/2 Power Select Jumper
20. SYS_FAN	System cooling fan connector
21. ATX12V	4-pin +12V power connector

This concludes Chapter 1. The next chapter explains how to install the motherboard.

## Introducing the Motherboard

**6**

## ***Memo***

**Introducing the Motherboard**

## Chapter 2

### *Installing the Motherboard*

---

#### **Safety Precautions**

- Follow these safety precautions when installing the motherboard
- Wear a grounding strap attached to a grounded device to avoid damage from static electricity
- Discharge static electricity by touching the metal case of a safely grounded object before working on the motherboard
- Leave components in the static-proof bags they came in
- Hold all circuit boards by the edges. Do not bend circuit boards

#### **Choosing a Computer Case**

There are many types of computer cases on the market. The motherboard complies with the specifications for the Micro ATX system case. First, some features on the motherboard are implemented by cabling connectors on the motherboard to indicators and switches on the system case. Make sure that your case supports all the features required. Secondly, this motherboard supports one floppy diskette drive and two enhanced IDE drives. Make sure that your case has sufficient power and space for all drives that you intend to install.

Most cases have a choice of I/O templates in the rear panel. Make sure that the I/O template in the case matches the I/O ports installed on the rear edge of the motherboard.

This motherboard carries a Micro ATX form factor of 244 x 200 mm. Choose a case that accommodates this form factor.

#### **Installing the Motherboard in a Case**

Refer to the following illustration and instructions for installing the motherboard in a case.

Most system cases have mounting brackets installed in the case, which correspond the holes in the motherboard. Place the motherboard over the mounting brackets and secure the motherboard onto the mounting brackets with screws.

Ensure that your case has an I/O template that supports the I/O ports and expansion slots on your motherboard.

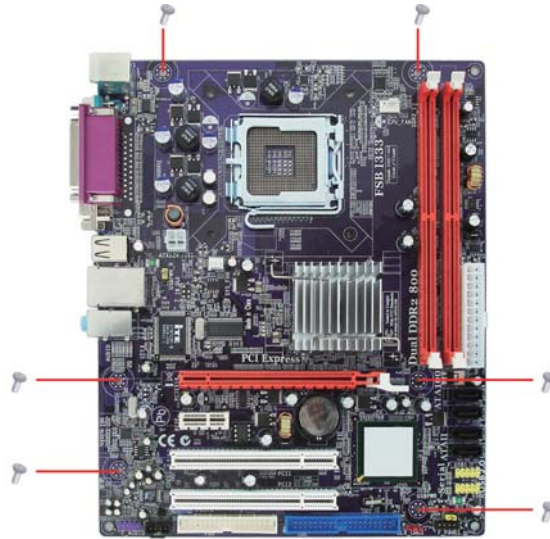

*Do not over-tighten the screws as this can stress the motherboard.*

## Checking Jumper Settings

This section explains how to set jumpers for correct configuration of the motherboard.

### Setting Jumpers

Use the motherboard jumpers to set system configuration options. Jumpers with more than one pin are numbered. When setting the jumpers, ensure that the jumper caps are placed on the correct pins.

The illustrations show a 2-pin jumper. When the jumper cap is placed on both pins, the jumper is SHORT. If you remove the jumper cap, or place the jumper cap on just one pin, the jumper is OPEN.



**SHORT**



**OPEN**

This illustration shows a 3-pin jumper. Pins 1 and 2 are SHORT.

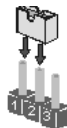



## Installing the Motherboard

### Checking Jumper Settings

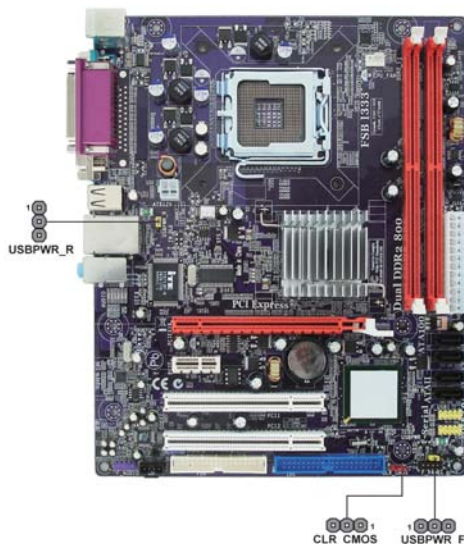
The following illustration shows the location of the motherboard jumpers. Pin 1 is labeled.



### Jumper Settings

Jumper	Type	Description	Setting (default)	
CLR_CMOS	3-pin	Clear CMOS	1-2: NORMAL 2-3: CLEAR CMOS Before clearing the CMOS, make sure to turn off the system.	 1 CLR_CMOS
USBPWR_F	3-pin	Front Panel USB Power Select Jumper	1-2: VCC 2-3: 5VSB	1  USBPWR_F
USBPWR_R	3-pin	Rear USB PS/2 Power Select Jumper	1-2: VCC 2-3: 5VSB	1  USBPWR_R



1. To avoid the system instability after clearing CMOS, we recommend users to enter the main BIOS setting page to "Load Optimal Defaults" and then "Save Changes and Exit".
2. Make sure the power supply provides enough 5VSB voltage before selecting the 5VSB function.
3. It is required that users place the USBPWR\_F & USBPWR\_R cap onto 2-3 pin rather than 1-2 pin as default if you want to wake up the computer by USB/PS2 KB/Mouse.

## Installing the Motherboard

## Installing Hardware

### *Installing the Processor*



*Caution: When installing a CPU heatsink and cooling fan make sure that you DO NOT scratch the motherboard or any of the surface-mount resistors with the clip of the cooling fan. If the clip of the cooling fan scrapes across the motherboard, you may cause serious damage to the motherboard or its components.*

*On most motherboards, there are small surface-mount resistors near the processor socket, which may be damaged if the cooling fan is carelessly installed.*

*Avoid using cooling fans with sharp edges on the fan casing and the clips. Also, install the cooling fan in a well-lit work area so that you can clearly see the motherboard and processor socket.*

### **Before installing the Processor**

This motherboard automatically determines the CPU clock frequency and system bus frequency for the processor. You may be able to change the settings in the system Setup Utility. We strongly recommend that you do not over-clock processors or other components to run faster than their rated speed.



*Warning:*

*1. Over-clocking components can adversely affect the reliability of the system and introduce errors into your system. Over-clocking can permanently damage the motherboard by generating excess heat in components that are run beyond the rated limits.*

*2. Always remove the AC power by unplugging the power cord from the power outlet before installing or removing the motherboard or other hardware components.*

This motherboard has an LGA775 socket. When choosing a processor, consider the performance requirements of the system. Performance is based on the processor design, the clock speed and system bus frequency of the processor, and the quantity of internal cache memory and external cache memory.

## Installing the Motherboard

## CPU Installation Procedure

The following illustration shows CPU installation components.

- A. Read and follow the instructions shown on the sticker on the CPU cap.



- B. Unload the cap
- Use thumb & forefinger to hold the lifting tab of the cap.
  - Lift the cap up and remove the cap completely from the socket.

- C. Open the load plate
- Use thumb & forefinger to hold the hook of the lever, pushing down and pulling aside unlock it.
  - Lift up the lever.
  - Use thumb to open the load plate. Be careful not to touch the contacts.



- D. Install the CPU on the socket
- Orientate CPU package to the socket. Make sure you match triangle marker to pin 1 location.



- E. Close the load plate
- Slightly push down the load plate onto the tongue side, and hook the lever.
  - CPU is locked completely.



- F. Apply thermal grease on top of the CPU.

- G. Fasten the cooling fan supporting base onto the CPU socket on the motherboard.

- H. Make sure the CPU fan is plugged to the CPU fan connector. Please refer to the CPU cooling fan user's manual for more detail installation procedure.



1. To achieve better airflow rates and heat dissipation, we suggest that you use a high quality fan with 3800 rpm at least. CPU fan and heatsink installation procedures may vary with the type of CPU fan/ heatsink supplied. The form and size of fan/heatsink may also vary.

2. DO NOT remove the CPU cap from the socket before installing a CPU.

3. Return Material Authorization (RMA) requests will be accepted only if the motherboard comes with the cap on the LGA775 socket.

## Installing the Motherboard

### *Installing Memory Modules*

This motherboard accommodates two memory modules. It can support two 240-pin DDR2 800/667. The total memory capacity is 4 GB.

#### **DDR2 SDRAM memory module table**

Memory module	Memory Bus
<i>DDR2 667</i>	<i>333 MHz</i>
<i>DDR2 800</i>	<i>400 MHz</i>

You must install at least one module in any of the two slots. Each module can be installed with 2 GB of memory; total memory capacity is 4 GB.



*Do not remove any memory module from its antistatic packaging until you are ready to install it on the motherboard. Handle the modules only by their edges. Do not touch the components or metal parts. Always wear a grounding strap when you handle the modules.*

### **Installation Procedure**

Refer to the following to install the memory modules.

- 1 This motherboard supports unbuffered DDR2 SDRAM .
- 2 Push the latches on each side of the DIMM slot down.
- 3 Align the memory module with the slot. The DIMM slots are keyed with notches and the DIMMs are keyed with cutouts so that they can only be installed correctly.
- 4 Check that the cutouts on the DIMM module edge connector match the notches in the DIMM slot.
- 5 Install the DIMM module into the slot and press it firmly down until it seats correctly. The slot latches are levered upwards and latch on to the edges of the DIMM.
- 6 Install any remaining DIMM modules.

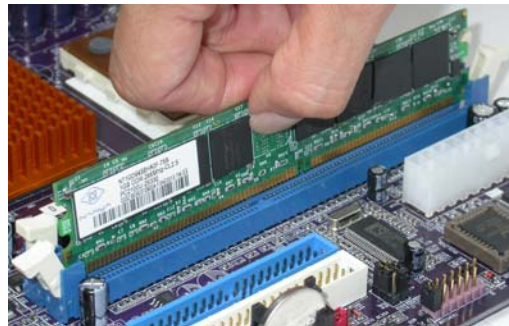

## **Installing the Motherboard**



**Table A: DDR2 (memory module) QVL (Qualified Vendor List)**

The following DDR2 800/667 memory modules have been tested and qualified for use with this motherboard.

Type	Size	Vendor	Module Name
DDR2 667	512 MB	Corsair	VALUESELECT 32M8CEC
			64M8CFE PS1000545
			Corsair K4T51083QC
		GEIL	GL2L64M088BA18W
		Ramaxel	5LB31 D9DCL
		SAMSUNG	K4T51083QC
		SyncMAX	E5108AB-5C-E
	1 GB	Transcend	SEL520ZCE6 K4T51083QC
			JetRam J12Q3AB-6
			Elpida 1GB AM4B5708GEWS7E-0637F
		APACER	AM4B5708GQJS7E0631F
			78.91G92.9K5
			78.01G90.9K5
		APOGEE	AU51082-667P005
		Micron	MT4HTF6464AY-667E1
			MT8HTF12864AY-667E1
			AL7E8E63B-6E1T
	PSC	AL7E8F73C-6E1	
		AL6E8E63J-6E1	
		Aeneon	AET860UD00-30DB08X
	2 GB	Apacer	78.A1G90.9K4
		Hynix	HYMP125U64AP8-Y5-AB-A
		LeadMax	LeadMax LD5PS1G831
PSC		AL8E8F73C-6E1	
Qimonda		HYS64T256020EU-3S-C2	
CORSAIR		CM2X1024-6400PRO	
DDR2 800	512 MB	Infinity	CM2X1024-6400PRO
			04751208CZ5U2D
		Kingston	04701G16CZ5U2G
			KHX6400D2ULK2/1G
			KVR800D2N5/1G
			KVR800D2N5/1G
	Micron	MT8HTF6464AY-80ED4	
	SyncMAX	U538H8G090HL	
	UMAX	U2S12D30TP-8E	
	1 GB	Aeneon	AET760UD00-25DC08X
APACER		78.01GA0.9K5	
Infinity		04701G16CZ5U2G	
Kingston		KVR800D2N5/1G	
NPC		NCPT7AUDR-25M48	
		IMEAER422LA0112	
	MEAER421LA0110-08A6		
PQI	MEAER422LB0107		
	Aeneon	AET860UD00-25DC08X	
	2 GB	Apacer	78.A1GA0.9K4
Micron		MT16HTF25664AY-800E1	
PSC		AL8E8F73C-8E1	
Qimonda		HYS64T256020EU-25F-C2	
Silicon Power		SP002GBLRU800S01	

## Installing the Motherboard

## Expansion Slots

### Installing Add-on Cards

The slots on this motherboard are designed to hold expansion cards and connect them to the system bus. Expansion slots are a means of adding or enhancing the motherboard's features and capabilities. With these efficient facilities, you can increase the motherboard's capabilities by adding hardware that performs tasks that are not part of the basic system.

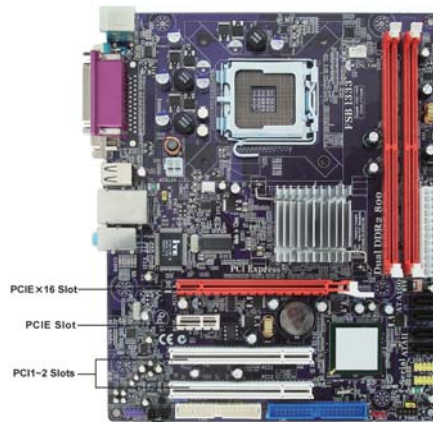

**PCIEX16 Slot** The PCI Express slot is used to install an external PCI Express graphics card that is fully compliant to the PCI Express Base Specification revision 1.1.

**PCIEX1 Slot** The PCI Express x1 slot is fully compliant to the PCI Express Base Specification revision 1.1.

**PCI1~2 Slots** This motherboard is equipped with two standard PCI slots. PCI stands for Peripheral Component Interconnect and is a bus standard for expansion cards, which for the most part, is a supplement of the older ISA bus standard. The PCI slots on this board are PCI v2.3 compliant.



*Before installing an add-on card, check the documentation for the card carefully. If the card is not Plug and Play, you may have to manually configure the card before installation.*

## Installing the Motherboard

Follow these instructions to install an add-on card:

- 1 Remove a blanking plate from the system case corresponding to the slot you are going to use.
- 2 Install the edge connector of the add-on card into the expansion slot. Ensure that the edge connector is correctly seated in the slot.
- 3 Secure the metal bracket of the card to the system case with a screw.

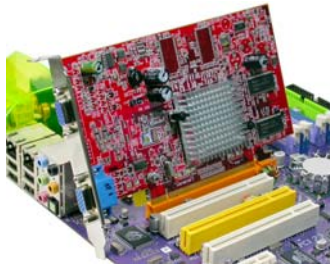

*1. For some add-on cards, for example graphics adapters and network adapters, you have to install drivers and software before you can begin using the add-on card.*

*2. The onboard PCI interface does not support 64-bit SCSI cards.*

## Installing the Motherboard

### Connecting Optional Devices

Refer to the following for information on connecting the motherboard's optional devices:



#### F\_AUDIO: Front Panel Audio header for Azalia

This header allows the user to install auxiliary front-oriented microphone and line-out ports for easier access.

Pin	Signal Name	Pin	Signal Name
1	PORT 1L	2	AUD_GND
3	PORT 1R	4	PRESENCE#
5	PORT 2R	6	SENSE1_RETURN
7	SENSE_SEND	8	KEY
9	PORT 2L	10	SENSE2_RETURN

#### SATA1~4: Serial ATA connectors

These connectors are used to support the new Serial ATA devices for the highest data transfer rates (3.0 Gb/s), simpler disk drive cabling and easier PC assembly. It eliminates limitations of the current Parallel ATA interface. But maintains register compatibility and software compatibility with Parallel ATA.

Pin	Signal Name	Pin	Signal Name
1	Ground	2	TX+
3	TX-	4	Ground
5	RX-	6	RX+
7	Ground	-	-

## Installing the Motherboard

### F\_USB1~2: Front Panel USB headers

The motherboard has four USB ports installed on the rear edge I/O port array. Additionally, some computer cases have USB ports at the front of the case. If you have this kind of case, use auxiliary USB connector to connect the front-mounted ports to the motherboard.

Pin	Signal Name	Function
1	USBPWR	Front Panel USB Power
2	USBPWR	Front Panel USB Power
3	USB_FP_P0-	USB Port 0 Negative Signal
4	USB_FP_P1-	USB Port 1 Negative Signal
5	USB_FP_P0+	USB Port 0 Positive Signal
6	USB_FP_P1+	USB Port 1 Positive Signal
7	GND	Ground
8	GND	Ground
9	Key	No pin
10	USB_FP_OC0	Overcurrent signal



Please make sure that the USB cable has the same pin assignment as indicated above. A different pin assignment may cause damage or system hang-up.

### CD\_IN: Analog Audio Input connector

Pin	Signal Name	Function
1	CD_L	CD In left channel
2	GND	Ground
3	GND	Ground
4	CD_R	CD In right channel

### SPDIFO: SPDIF out header

This is an optional header that provides an S/PDIF (Sony/Philips Digital Interface) output to digital multimedia device through optical fiber or coaxial connector.

Pin	Signal Name	Function
1	SPDIF	SPDIF digital output
2	+5VA	5V analog Power
3	Key	No pin
4	GND	Ground

## Installing the Motherboard

### ***Installing a Hard Disk Drive/CD-ROM/SATA Hard Drive***

This section describes how to install IDE devices such as a hard disk drive and a CD-ROM drive.

#### **About IDE Devices**

Your motherboard has one IDE channel interface.

#### **IDE: IDE Connector**

This motherboard supports four high data transfer SATA ports with each runs up to 3.0 Gb/s. To get better system performance, we recommend users connect the CD-ROM to the IDE channel, and set up the hard drives on the SATA ports.

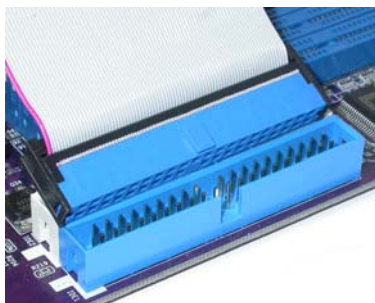

IDE devices enclose jumpers or switches used to set the IDE device as MASTER or SLAVE. Refer to the IDE device user's manual. Installing two IDE devices on one cable, ensure that one device is set to MASTER and the other device is set to SLAVE. The documentation of your IDE device explains how to do this.

#### **About SATA Connectors**

Your motherboard features four SATA connectors supporting a total of four drives. SATA refers to Serial ATA (Advanced Technology Attachment) is the standard interface for the IDE hard drives which are currently used in most PCs. These connectors are well designed and will only fit in one orientation. Locate the SATA connectors on the motherboard and follow the illustration below to install the SATA hard drives.

#### **Installing Serial ATA Hard Drives**

To install the Serial ATA (SATA) hard drives, use the SATA cable that supports the Serial ATA protocol. This SATA cable comes with an SATA power cable. You can connect either end of the SATA cable to the SATA hard drive or the connector on the motherboard.



**SATA cable** (optional)



**SATA power cable** (optional)

Installing the Motherboard

Refer to the illustration below for proper installation:

- 1 Attach either cable end to the connector on the motherboard.
- 2 Attach the other cable end to the SATA hard drive.
- 3 Attach the SATA power cable to the SATA hard drive and connect the other end to the power supply.



*This motherboard does not support the “Hot-Plug” function.*

### ***Installing a Floppy Diskette Drive***

#### **FDD: Floppy Disk Connector**

Connect the single end of the floppy connector to the onboard floppy connector firstly, and then connect the remaining plugs on the other end to the floppy drives correspondingly.



*You must orient the cable connector so that the pin 1 (color) edge of the cable corresponds to the pin 1 of the I/O port connector.*



## **Installing the Motherboard**

## Connecting I/O Devices

The backplane of the motherboard has the following I/O ports:

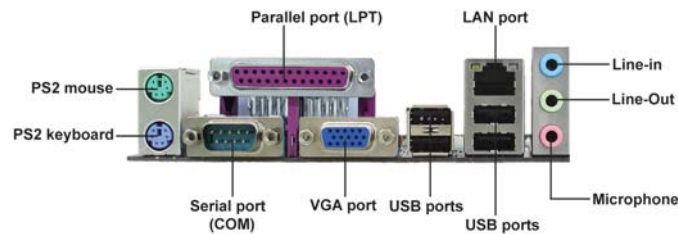

- PS2 Mouse** Use the upper PS/2 port to connect a PS/2 pointing device.
- PS2 Keyboard** Use the lower PS/2 port to connect a PS/2 keyboard.
- Serial Port (COM)** Use the COM port to connect serial devices such as mice or fax/modems.
- VGA Port** Connect your monitor to the VGA port.
- Parallel Port (LPT)** Use LPT to connect printers or other parallel communications devices.
- LAN Port** Connect an RJ-45 jack to the LAN port to connect your computer to the Network.
- USB Ports** Use the USB ports to connect USB devices.
- Audio Ports** Use the three audio ports to connect audio devices. The first jack is for stereo line-in signal. The second jack is for stereo line-out signal. The third jack is for microphone.

## Installing the Motherboard



## Connecting Case Components

After you have installed the motherboard into a case, you can begin connecting the motherboard components. Refer to the following:

- 1 Connect the CPU cooling fan cable to **CPU\_FAN**.
- 2 Connect the system cooling fan connector to **SYS\_FAN**.
- 3 Connect the case switches and indicator LEDs to the **F\_PANEL**.
- 4 Connect the case speaker cable to **SPK**.
- 5 Connect the standard power supply connector to **ATX\_POWER**.
- 6 Connect the auxiliary case power supply connector to **ATX12V**.

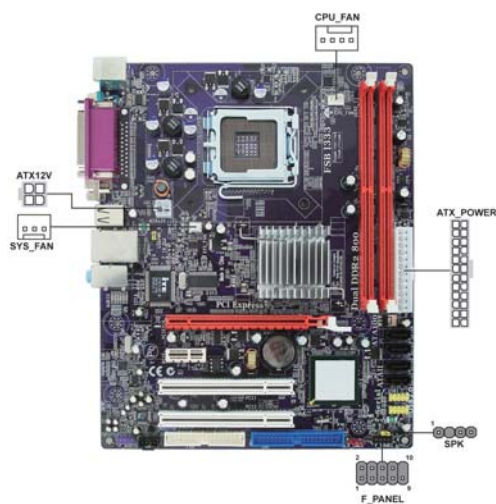

### Connecting 24-pin power cable

The ATX\_POWER 24-pin connector allows you to connect to ATX v2.x power supply.

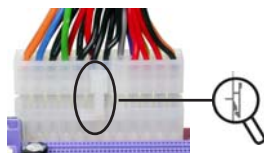

24-pin power cable

With ATX v2.x power supply, users please note that when installing 24-pin power cable, the latches of power cable and the ATX\_POWER match perfectly.



### Connecting 4-pin power cable

The ATX12V power connector is used to provide power to the CPU.

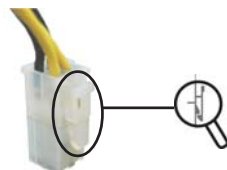

4-pin power cable

When installing 4-pin power cable, the latches of power cable and the ATX12V match perfectly.

**CPU\_FAN: CPU Cooling FAN Power Connector**

Pin	Signal Name	Function
1	GND	System Ground
2	+12V	Power +12V
3	Sense	Sensor
4	PWM	PWM



*Users please note that the fan connector supports the CPU cooling fan of 1.1A ~ 2.2A (26.4W max) at +12V.*

**SYS\_FAN: System Cooling FAN Power Connector**

Pin	Signal Name	Function
1	GND	System Ground
2	+12V	Power +12V
3	Sense	Sensor

**ATX\_POWER: ATX 24-pin Power Connector**

Pin	Signal Name	Pin	Signal Name
1	+3.3V	13	+3.3V
2	+3.3V	14	-12V
3	Ground	15	Ground
4	+5V	16	PS_ON
5	Ground	17	Ground
6	+5V	18	Ground
7	Ground	19	Ground
8	PWRGD	20	-5V
9	+5VSB	21	+5V
10	+12V	22	+5V
11	+12V	23	+5V
12	+3.3V	24	Ground

**ATX12V: ATX 12V Power Connector**

Pin	Signal Name
1	Ground
2	Ground
3	+12V
4	+12V

**SPK: Internal speaker**

Pin	Signal Name
1	VCC
2	Key
3	NC
4	Signal

**Front Panel Header**

The front panel header (F\_PANEL) provides a standard set of switch and LED headers commonly found on ATX or micro-ATX cases. Refer to the table below for information:

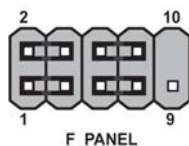

Pin	Signal	Function	Pin	Signal	Function
1	HD_LED_P	Hard disk LED (+)	2	FP PWR/SLP	*MSG LED (+)
3	HD_LED_N	Hard disk LED (-)	4	FP PWR/SLP	*MSG LED (-)
5	RST_SW_N	Reset Switch (-)	6	PWR_SW_P	Power Switch (+)
7	RST_SW_P	Reset Switch (+)	8	PWR_SW_N	Power Switch (-)
9	RSVD	Reserved	10	Key	No pin

\* MSG LED (dual color or single color)

**Hard Drive Activity LED**

Connecting pins 1 and 3 to a front panel mounted LED provides visual indication that data is being read from or written to the hard drive. For the LED to function properly, an IDE drive should be connected to the onboard IDE interface. The LED will also show activity for devices connected to the SCSI (hard drive activity LED) connector.

**Power/Sleep/Message waiting LED**

Connecting pins 2 and 4 to a single or dual-color, front panel mounted LED provides power on/off, sleep, and message waiting indication.

**Reset Switch**

Supporting the reset function requires connecting pin 5 and 7 to a momentary-contact switch that is normally open. When the switch is closed, the board resets and runs POST.

**Power Switch**

Supporting the power on/off function requires connecting pins 6 and 8 to a momentary-contact switch that is normally open. The switch should maintain contact for at least 50 ms to signal the power supply to switch on or off. The time requirement is due to internal de-bounce circuitry. After receiving a power on/off signal, at least two seconds elapses before the power supply recognizes another on/off signal.

This concludes Chapter 2. The next chapter covers the BIOS.

## Installing the Motherboard

***Memo***

**Installing the Motherboard**

## Chapter 3

### *Using BIOS*

---

#### About the Setup Utility

The computer uses the latest “American Megatrends Inc.” BIOS with support for Windows Plug and Play. The CMOS chip on the motherboard contains the ROM setup instructions for configuring the motherboard BIOS.

The BIOS (Basic Input and Output System) Setup Utility displays the system’s configuration status and provides you with options to set system parameters. The parameters are stored in battery-backed-up CMOS RAM that saves this information when the power is turned off. When the system is turned back on, the system is configured with the values you stored in CMOS.

The BIOS Setup Utility enables you to configure:

- Hard drives, diskette drives and peripherals
- Video display type and display options
- Password protection from unauthorized use
- Power Management features

The settings made in the Setup Utility affect how the computer performs. Before using the Setup Utility, ensure that you understand the Setup Utility options.

This chapter provides explanations for Setup Utility options.

#### *The Standard Configuration*

A standard configuration has already been set in the Setup Utility. However, we recommend that you read this chapter in case you need to make any changes in the future.

This Setup Utility should be used:

- when changing the system configuration
- when a configuration error is detected and you are prompted to make changes to the Setup Utility
- when trying to resolve IRQ conflicts
- when making changes to the Power Management configuration
- when changing the password or making other changes to the Security Setup

#### *Entering the Setup Utility*

When you power on the system, BIOS enters the Power-On Self Test (POST) routines. POST is a series of built-in diagnostics performed by the BIOS. After the POST routines are completed, the following message appears:

**Press DEL to enter SETUP**

**Using BIOS**

Press the delete key to access the BIOS Setup Utility.

CMOS Setup Utility -- Copyright (C) 1985-2005, American Megatrends, Inc.

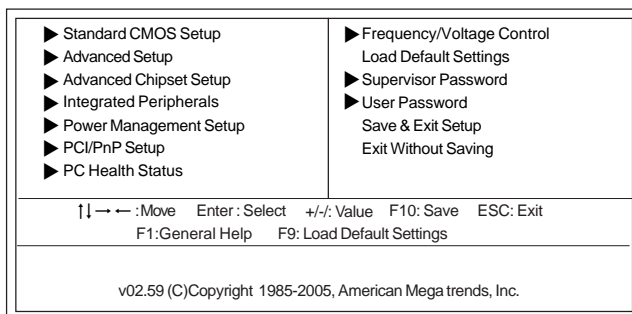

## Using BIOS

When you start the Setup Utility, the main menu appears. The main menu of the Setup Utility displays a list of the options that are available. A highlight indicates which option is currently selected. Use the cursor arrow keys to move the highlight to other options. When an option is highlighted, execute the option by pressing <Enter>.

Some options lead to pop-up dialog boxes that prompt you to verify that you wish to execute that option. Other options lead to dialog boxes that prompt you for information.

Some options (marked with a triangle ►) lead to submenus that enable you to change the values for the option. Use the cursor arrow keys to scroll through the items in the submenu.

In this manual, default values are enclosed in parenthesis. Submenu items are denoted by a triangle ►.



*The default BIOS setting for this motherboard applies for most conditions with optimum performance. It is not suggested to change the default values in the BIOS setup and the manufacture takes no responsibility to any damage caused by changing the BIOS settings.*

### BIOS Navigation Keys

The BIOS navigation keys are listed below:

KEY	FUNCTION
ESC	Exits the current menu
↑↓←→	Scrolls through the items on a menu
+/-	Modifies the selected field's values
Enter	Select
F9	Loads an optimized setting for better performance
F10	Saves the current configuration and exits setup
F1	Displays a screen that describes all key functions

Using BIOS



For the purpose of better product maintenance, the manufacture reserves the right to change the BIOS items presented in this manual. The BIOS setup screens shown in this chapter are for reference only and may differ from the actual BIOS. Please visit the manufacture's website for updated manual.

### Standard CMOS Setup

This option displays basic information about your system.

CMOS Setup Utility -- Copyright (C) 1985-2005, American Megatrends, Inc.  
Standard CMOS Setup

Date	Thu 05/29/2008	Help Item
Time	18 : 47 : 06	
▶ Primary IDE Master	Hard Disk	User [Enter], [TAB] or [SHIFT-TAB] to select a field. Use [+] or [-] to configure system Date.
▶ Primary IDE Slave	Not Detected	
▶ Secondary IDE Master	Not Detected	
▶ Secondary IDE Slave	Not Detected	
▶ Third IDE Master	ATAPI CDROM	
▶ Third IDE Slave	Not Detected	
IDE BusMaster	Enabled	
Drive A:	1.44 MB 3 $\frac{1}{2}$ "	

↑↓ → ← : Move Enter : Select +/- : Value F10: Save ESC: Exit  
F1: General Help F9: Load Default Settings

#### Date & Time

The Date and Time items show the current date and time on the computer. If you are running a Windows OS, these items are automatically updated whenever you make changes to the Windows Date and Time Properties utility.

#### ▶ Primary/Secondary/Third IDE Master/Slave

Your computer has one IDE channel and each channel can be installed with one or two devices (Master and Slave). In addition, this motherboard supports four SATA channels and each channel allows one SATA device to be installed. Use these items to configure each device on the SATA channel.

CMOS SETUP UTILITY – Copyright (C) 1985-2005, American Megatrends, Inc.  
Primary IDE Master

Primary IDE Master		Help Item
Device :	Hard Disk	Select the type of device connected to the system.
Vendor:	ST3320620AS	
Size:	309.8GB	
LBA Mode:	Supported	
Block Mode:	16Sectors	
PIO Mode:	4	
Async DMA:	MultiWord DMA-2	
Ultra DMA:	Ultra DMA-6	
S.M.A.R.T.:	Supported	
Type	Auto	
LBA/Large Mode	Auto	
Block (Multi-Sector Transfer)	Auto	
PIO Mode	Auto	
DMA Mode	Auto	
S.M.A.R.T	Auto	
32Bit Data Transfer	Enabled	

↑↓ → ← : Move Enter : Select +/- : Value F10: Save ESC: Exit  
F1: General Help F9: Load Default Settings

#### **Type (Auto)**

Use this item to configure the type of the IDE device that you specify. If the feature is enabled, it will enhance hard disk performance by reading or writing more data during each transfer.

#### **LBA/Large Mode (Auto)**

Use this item to set the LAB/Large mode to enhance hard disk performance by optimizing the area the hard disk is visited each time.

#### **Block (Multi-Sector Transfer) (Auto)**

If the feature is enabled, it will enhance hard disk performance by reading or writing more data during each transfer.

#### **PIO Mode (Auto)**

Use this item to set the PIO mode to enhance hard disk performance by optimizing the hard disk timing.

#### **DMA Mode (Auto)**

DMA capability allows user to improve the transfer-speed and data-integrity for compatible IDE devices.

#### **S.M.A.R.T. (Auto)**

The S.M.A.R.T. (Self-Monitoring, Analysis and Reporting Technology) system is a diagnostics technology that monitors and predicts device performance. S.M.A.R.T. software resides on both the disk drive and the host computer.

#### **32Bit Data Transfer (Enabled)**

Use this item to set the onboard SATA-IDE channel to be disabled, IDE, or RAID.

Press <Esc> to return to the Standard CMOS Setup page.

#### **IDE BusMaster (Enabled)**

This item enables or disables the DMA under DOS mode. We recommend you to leave this item at the default value.

## Using BIOS



**Type (Auto)**

Use this item to configure the type of the IDE device that you specify. If the feature is enabled, it will enhance hard disk performance by reading or writing more data during each transfer.

**LBA/Large Mode (Auto)**

Use this item to set the LAB/Large mode to enhance hard disk performance by optimizing the area the hard disk is visited each time.

**Block (Multi-Sector Transfer) (Auto)**

If the feature is enabled, it will enhance hard disk performance by reading or writing more data during each transfer.

**PIO Mode (Auto)**

Use this item to set the PIO mode to enhance hard disk performance by optimizing the hard disk timing.

**DMA Mode (Auto)**

DMA capability allows user to improve the transfer-speed and data-integrity for compatible IDE devices.

**S.M.A.R.T. (Auto)**

The S.M.A.R.T. (Self-Monitoring, Analysis and Reporting Technology) system is a diagnostics technology that monitors and predicts device performance. S.M.A.R.T. software resides on both the disk drive and the host computer.

**32Bit Data Transfer (Enabled)**

Use this item to set the onboard SATA-IDE channel to be disabled, IDE, or RAID.

Press <Esc> to return to the Standard CMOS Setup page.

**IDE BusMaster (Enabled)**

This item enables or disables the DMA under DOS mode. We recommend you to leave this item at the default value.

**Drive A (1.44 MB 3<sup>1</sup>/<sub>2</sub>" )**

This item defines the characteristics of any diskette drive attached to the system.

You can connect one diskette drive.

Press <Esc> to return to the main menu setting page.

**Quick Power on Self Test (Enabled)**

Enable this item to shorten the power on testing (POST) and have your system start up faster. You might like to enable this item after you are confident that your system hardware is operating smoothly.

**Boot Up Numlock Status (On)**

This item defines if the keyboard Num Lock key is active when your system is started.

**APIC Mode (Enabled)**

This item allows you to enable or disable the APCI (Advanced Programmable Interrupt Controller) mode. APIC provides symmetric multi-processing (SMP) for systems, allowing support for up to 60 processors.

**1st/2nd/3rd Boot Device (ST3320620AS/BENQ DVD DC DW1810/1st FLOPPY DRIVE)**

Use this item to determine the device order the computer used to look for an operating system to load at start-up time. The devices showed here will be different depending on the exact devices installed on your motherboard.

**► Hard Disk Drives (Press Enter)**

Scroll to this item and press <Enter> to view the following screen:

CMOS Setup Utility - Copyright (C) 1985-2005, American Megatrends, Inc.  
Hard Disk Drives

Hard Disk Drives	Help Item
1st Drive      ST3320620AS	Specifies the boot sequence from the available devices.

↑↓ → ← : Move    Enter: Select    +/-: Value    F10: Save    ESC: Exit  
F1: General Help    F9: Load Default Settings

Press <Esc> to return to the Advanced Setup page.

### ► Removable Drives (Press Enter)

Scroll to this item and press <Enter> to view the following screen:

CMOS Setup Utility - Copyright (C) 1985-2005, American Megatrends, Inc.  
Removable Drives

Removable Drives	Help Item
1st Drive <b>1st FLOPPY DRIVE</b>	Specifies the boot sequence from the available devices.

↑↓ → ← : Move    Enter : Select    +/- : Value    F10: Save    ESC: Exit  
F1: General Help    F9: Load Default Settings

Press <Esc> to return to the Advanced Setup page.

### ► CD/DVD Drives (Press Enter)

Scroll to this item and press <Enter> to view the following screen:

CMOS Setup Utility - Copyright (C) 1985-2005, American Megatrends, Inc.  
CD/DVD Drives

CD/DVD Drives	Help Item
1st Drive <b>BENQ DVD DC DW1810</b>	Specifies the boot sequence from the available devices.

↑↓ → ← : Move    Enter : Select    +/- : Value    F10: Save    ESC: Exit  
F1: General Help    F9: Load Default Settings

Press <Esc> to return to the Advanced Setup page.

### Boot Other Device (Yes)

When enabled, the system searches all other possible locations for an operating system if it fails to find one in the devices specified under the First, Second and Third boot devices.

Press <Esc> to return to the main menu setting page.

### Advanced Chipset Setup

This page sets up more advanced information about your system. Handle this page with caution. Any changes can affect the operation of your computer.

CMOS Setup Utility - Copyright (C) 1985-2005, American Megatrends, Inc.  
Advanced Chipset Setup

DRAM Frequency	Auto	Help Item
Configure DRAM Timing by SPD	Enabled	
VGA Share Memory	Enabled, 8MB	Options
DVMT Mode Select	DVMT Mode	
DVMT/FIXED Memory	256MB	Auto
HPET	Enabled	667 MHz
		800 MHz

↑↓ → ← : Move Enter : Select +/- : Value F10: Save ESC: Exit  
F1: General Help F9: Optimized Defaults

#### DRAM Frequency (Auto)

This item enables users to adjust the DRAM frequency. The default setting is auto and we recommend users leave the setting unchanged. Modify it at will may cause the system to be unstable.

#### Configure DRAM Timing by SPD (Enabled)

When this item is set to enable, the DDR timing is configured using SPD. SPD (Serial Presence Detect) is located on the memory modules, BIOS reads information coded in SPD during system boot up.

#### VGA Share Memory (Enabled, 8MB)

This item lets you allocate a portion of the main memory for the onboard VGA display application.

#### DVMT Mode Select (DVMT Mode)

This item allows you to select the DVMT operating mode.

#### DVMT/FIXED Memory (256MB)

When set to Fixed Mode, the graphics driver will reserve a fixed portion of the system memory as graphics memory, according to system and graphics requirements.

#### HPET (Enabled)

This item enables or disables HPET (High Precision Event Timer) support.

Press <Esc> to return to the main menu setting page.

## Integrated Peripherals

This page sets up some parameters for peripheral devices connected to the system.

CMOS Setup Utility - Copyright (C) 1985-2005, American Megatrends, Inc.  
Integrated Peripherals

Onboard IDE Controller	Enabled	Help Item
OnBoard SATA Controller	Enhanced	
Onboard LAN Function	Enabled	DISABLED: disables the integrated IDE controller. ENABLED: enables both Controllers.
Onboard LAN Boot ROM	Disabled	
Onboard AUDIO Function	Enabled	
Serial Port1 Address	3F8/IRQ4	
Parallel Port Address	378	
Parallel Port Mode	ECP	
ECP Mode DMA Channel	DMA3	
Parallel Port IRQ	IRQ7	
USB Functions	Enabled	
Legacy USB Support	Enabled	

↑↓ → ← : Move Enter: Select +/-: Value F10: Save ESC: Exit  
F1: General Help F9: Load Default Settings

### Onboard IDE Controller (Enabled)

Use this item to enable or disable the onboard IDE interface.

### OnBoard SATA Controller (Enhanced)

This item allows you to enable or disable the onboard SATA controller.

### Onboard LAN Function (Enabled)

Use this item to enable or disable the onboard LAN function.

### Onboard LAN Boot ROM (Disabled)

Use this item to enable or disable the booting from the onboard LAN or a network add-in card with a remote boot ROM installed.

### Onboard AUDIO Function (Enabled)

Use this item to enable or disable the onboard audio device.

### Serial Port1 Address (3F8/IRQ4)

Use this item to enable or disable the onboard COM1 serial port, and to assign a port address.

### Parallel Port Address (378)

Use this item to enable or disable the onboard Parallel port, and to assign a port address.

### Parallel Port Mode (ECP)

Use this item to select the parallel port mode. You can select Normal (Standard Parallel Port), ECP (Extended Capabilities Port), EPP (Enhanced Parallel Port), or BPP (Bi-Directional Parallel Port).

### ECP Mode DMA Channel (DMA3)

Use this item to assign the DMA Channel under ECP Mode function.

## Using BIOS

**Parallel Port IRQ (IRQ7)**

Use this item to assign IRQ to the parallel port.

**USB Functions (Enabled)**

Use this item to enable or disable the USB function.

**Legacy USB Support (Enabled)**

Use this item to enable or disable support for legacy USB devices. Setting to Auto allows the system to detect the presence of USB device at startup. If detected, the USB controller legacy mode is enabled. If no USB device is detected, the legacy USB support is disabled.

Press <Esc> to return to the main menu setting page.

**Power Management Setup**

This page sets up some parameters for system power management operation.

CMOS Setup Utility - Copyright (C) 1985-2005, American Megatrends, Inc.  
Power Management Setup

ACPI Suspend Type	S3	Help Item
Soft-off by PWR-BTTN	Delay 4 Sec	Select the ACPI state used for System Suspend.
PWRON After PWR-Fail	Power Off	
Resume By RING	Disabled	
Resume By PCI/PCI-E/Lan PME	Disabled	
Resume By USB (S3)	Disabled	
Resume By PS2 KB (S3)	Disabled	
Resume By PS2 MS (S3)	Disabled	
Resume on RTC Alarm	Disabled	

↑↓ → ← : Move Enter : Select +/- : Value F10: Save ESC: Exit  
F1: General Help F9: Load Default Settings

**ACPI Suspend Type (S3)**

Use this item to define how your system suspends. In the default, S3, the suspend mode is a suspend to RAM, i.e., the system shuts down with the exception of a refresh current to the system memory.

**Soft-Off by PWR-BTTN (Delay 4 Sec)**

Under ACPI (Advanced Configuration and Power management Interface) you can create a software power down. In a software power down, the system can be resumed by Wake Up Alarms. This item lets you install a software power down that is controlled by the power button on your system. If the item is set to Instant-Off, then the power button causes a software power down. If the item is set to Delay 4 Sec, then you have to hold the power button down for four seconds to cause a software power down.

**PWRON After PWR-Fail (Power Off)**

This item enables your computer to automatically restart or return to its operating status.

**Resume By RING (Disabled)**

An input signal on the serial Ring Indicator (RI) line (in other words, an incoming call on the modem) awakens the system from a soft off state.

**Resume By PCI/PCI-E/Lan PME (Disabled)**

These items specify whether the system will be awakened from power saving modes when activity or input signal of the specified hardware peripheral or component is detected.

**Resume By USB (S3) (Disabled)**

This item allows you to enable/disable the USB device wakeup function from S3/S4 mode.

**Resume By PS2 KB (S3) (Disabled)**

This item enable or disable you to allow keyboard activity to awaken the system from power saving mode.

**Resume By PS2 MS (S3) (Disabled)**

This item enable or disable you to allow mouse activity to awaken the system from power saving mode.

**Resume on RTC Alarm (Disabled)**

The system can be turned off with a software command. If you enable this item, the system can automatically resume at a fixed time based on the system's RTC (realtime clock). Use the items below this one to set the date and time of the wake-up alarm. You must use an ATX power supply in order to use this feature.

Press <Esc> to return to the main menu setting page.

### PCI / PnP Setup

This page sets up some parameters for devices installed on the PCI bus and those utilizing the system plug and play capability.

CMOS Setup Utility - Copyright (C) 1985-2005, American Megatrends, Inc.  
PCI / PnP Setup

		Help Item
Init Display First	PCI	Select which graphics controller to use as the primary boot device.
Allocate IRQ to PCI VGA	Yes	

↑↓←→ : Move    Enter : Select    +/- : Value    F10: Save    ESC: Exit  
F1: General Help    F9: Load Default Settings

#### Init Display First (PCI)

Use this item to select which graphics controller to use as the primary boot devices.

#### Allocate IRQ to PCI VGA (Yes)

If this item is enabled, an IRQ will be assigned to the PCI VGA graphics system. You set this value to No to free up an IRQ.

Press <Esc> to return to the main menu setting page.

### PC Health Status

On motherboards support hardware monitoring, this item lets you monitor the parameters for critical voltages, temperatures and fan speeds.

CMOS Setup Utility - Copyright (C) 1985-2005, American Megatrends, Inc.  
PC Health Status

		Help Item
Hardware Health Event Monitoring		
▶ Smart Fan Function	Press Enter	
Shutdown Temperature	Disabled	
CPU Temperature	:44°C/111°F	
CPU Fan Speed	:902 RPM	
CPU Vcore	:1.312 V	
VDIMM	:1.840 V	

↑↓←→ : Move    Enter : Select    +/- : Value    F10: Save    ESC: Exit  
F1: General Help    F9: Load Default Settings

## Using BIOS



### ► Smart Fan Function

Scroll to this item and press <Enter> to view the following screen:

CMOS Setup Utility - Copyright (C) 1985-2005, American Megatrends, Inc.  
Smart Fan Function

SMART Fan Control	Disabled	Help Item
		Options
		Disabled
		Enabled

↑↓ → ← :Move Enter : Select +/-: Value F10: Save ESC: Exit  
F1: General Help F9: Load Default Settings

### **SMART Fan Control (Disabled)**

This item allows you to enable/disable the control of the system fan speed by changing the fan voltage.



*ECS supports the latest PECI host technology. While using Wolfdale or Yorkfield CPU, the original images of the BIOS item "PC Health Status" and "Smart FAN Function" will be replaced by PECI mode and negative number. (The max data from PECI is zero.)*

CMOS Setup Utility - Copyright (C) 1985-2005, American Megatrends, Inc.  
PC Health Status

Hardware Health Event Monitoring		Help Item
► Smart Fan Function	Press Enter	
System Temperature	33°C/91°F	
CPU Fan Speed:	2537 RPM	
SYS FAN Speed:	0 RPM	
CPU Vcore:	1.280V	
VDIMM:	1.840V	
-- PECI Mode --		
Offset to TCC Activation Temp.:	-20	

↑↓ → ← :Move Enter : Select +/-: Value F10: Save ESC: Exit  
F1: General Help F9: Load Default Settings

## Using BIOS

CMOS Setup Utility - Copyright (C) 1985-2005, American Megatrends, Inc.  
Smart Fan Function

SMART Fan Control	Enabled	Help Item
SMART Fan start PWM value	28	
SMART Fan start Offset (-)	30	
CPU DeltaT	+3	
Fan1 Slope PWM value/1 Unit	5	
Fan1 Full Speed Offset (-)	10	
SMART Fan2 Control	Disabled	
		Options
		Disabled
		Enabled

↑↓ → ← : Move Enter : Select +/- : Value F10: Save ESC: Exit  
F1: General Help F9: Load Default Settings

Press <Esc> to return to the PC Health Status page.

### Shutdown Temperature (Disabled)

Enable you to set the maximum temperature the system can reach before powering down.

### System Component Characteristics

These items display the monitoring of the overall inboard hardware health events, such as System & CPU temperature, CPU & DIMM voltage, CPU & system fan speed,...etc.

- CPU Temperature
- CPU Fan Speed
- CPU Vcore
- VDIMM

Press <Esc> to return to the main menu setting page.

### Frequency/Voltage Control

This page enables you to set the clock speed and system bus for your system. The clock speed and system bus are determined by the kind of processor you have installed in your system.

CMOS Setup Utility - Copyright (C) 1985-2005, American Megatrends, Inc.  
Frequency/Voltage Control

Manufacturer: Intel Ratio Actual Value: 7 CPU Frequency : 333MHz CPU Over-clocking Func.: Disabled Auto Detect DIMM/PCI Clk Enabled Spread Spectrum Enabled		Help item <hr/> Options Disabled Enabled
--	--	---

↑↓ → ← : Move   Enter: Select   +/-: Value   F10: Save   ESC: Exit  
F1: General Help   F9: Load Default Settings

#### Manufacturer (Intel)

This item displays the information of current manufacturer of the CPU installed in your computer.

#### Ratio Actual Value (7)

These items show the Locked ratio status and the actual ratio of the CPU installed in your system.

#### CPU Frequency (333MHz)

This item indicates the current CPU frequency. Users can not make any change to this item. Please noted that the frequency will be varied with different CPU.

#### CPU Over-clocking Func. (Disabled)

This item decides the CPU over-clocking function installed in yoursystem. If the over-clocking fails, please turn off the system power. And then, hold the PageUp key (similar to the Clear CMOS function) and turn on the power, the BIOS will recover the safe default.

#### Auto Detect DIMM/PCI Clk (Enabled)

When this item is enabled, BIOS will disable the clock signal of free DIMM/PCI slots.

#### Spread Spectrum (Enabled)

If you enable spread spectrum, it can significantly reduce the EMI (Electro-Magnetic Interference) generated by the system.

Press <Esc> to return to the main menu setting page.

### ***Load Default Settings***

This option opens a dialog box that lets you install stability-oriented defaults for all appropriate items in the Setup Utility. Select <OK> and then press <Enter> to install the defaults. Select <Cancel> and then press <Enter> to not install the defaults.

### ***Supervisor Password***

This page helps you install or change a password.

CMOS Setup Utility - Copyright (C) 1985-2005, American Megatrends, Inc.  
Supervisor Password

Supervisor Password : Not Installed	Help item
Change Supervisor Password <span style="float: right;">Press Enter</span>	Install or Change the password.

↑↓←→: Move Enter: Select +/-: Value F10: Save ESC: Exit  
F1: General Help F9: Load Default Settings

#### **Supervisor Password (Not Installed)**

This item indicates whether a supervisor password has been set. If the password has been installed, *Installed* displays. If not, *Not Installed* displays.

#### **Change Supervisor Password (Press Enter)**

You can select this option and press <Enter> to access the sub menu. You can use the sub menu to change the supervisor password.

Press <Esc> to return to the main menu setting page.

### ***User Password***

This page helps you install or change a password.

CMOS Setup Utility - Copyright (C) 1985-2005, American Megatrends, Inc.  
User Password

User Password : Not Installed	Help item

↑↓←→ : Move Enter : Select +/- : Value F10: Save ESC: Exit  
F1: General Help F9: Load Default Settings

### **User Password (Not Installed)**

This item indicates whether a user password has been set. If the password has been installed, *Installed* displays. If not, *Not Installed* displays.

Press <Esc> to return to the main menu setting page.

### ***Save & Exit Setup***

Highlight this item and press <Enter> to save the changes that you have made in the Setup Utility and exit the Setup Utility. When the Save and Exit dialog box appears, select [OK] to save and exit, or select [Cancel] to return to the main menu.

### ***Exit Without Saving***

Highlight this item and press <Enter> to discard any changes that you have made in the Setup Utility and exit the Setup Utility. When the Exit Without Saving dialog box appears, select [OK] to discard changes and exit, or select [Cancel] to return to the main menu.



*If you have made settings that you do not want to save, use the “Exit Without Saving” item and select [OK] to discard any changes you have made.*

## **Using BIOS**

### *Updating the BIOS*

You can download and install updated BIOS for this motherboard from the manufacturer's Web site. New BIOS provides support for new peripherals, improvements in performance, or fixes for known bugs. Install new BIOS as follows:

- 1 If your motherboard has a BIOS protection jumper, change the setting to allow BIOS flashing.
- 2 If your motherboard has an item called Firmware Write Protect in Advanced BIOS features, disable it. (Firmware Write Protect prevents BIOS from being overwritten.)
- 3 Prepare a bootable device or create a bootable system disk. (Refer to Windows online help for information on creating a bootable system disk.)
- 4 Download the Flash Utility and new BIOS file from the manufacturer's Web site. Copy these files to the bootable device.
- 5 Turn off your computer and insert the bootable device in your computer. (You might need to run the Setup Utility and change the boot priority items on the Advanced BIOS Features Setup page, to force your computer to boot from the bootable device first.)
- 6 At the C:\ or A:\ prompt, type the Flash Utility program name and the file name of the new BIOS and then press <Enter>. Example: AMINF340.EXE040706.ROM
- 7 When the installation is complete, remove the bootable device from the computer and restart your computer. If your motherboard has a Flash BIOS jumper, reset the jumper to protect the newly installed BIOS from being overwritten. The computer will restart automatically.

This concludes Chapter 3. Refer to the next chapter for information on the software supplied with the motherboard.

## **Using BIOS**

## Chapter 4

### *Using the Motherboard Software*

---

#### **About the Software DVD-ROM/CD-ROM**

The support software DVD-ROM/CD-ROM that is included in the motherboard package contains all the drivers and utility programs needed to properly run the bundled products. Below you can find a brief description of each software program, and the location for your motherboard version. More information on some programs is available in a README file, located in the same directory as the software. Before installing any software, always inspect the folder for files named README.TXT or something similar. These files may contain important information that is not included in this manual.



1. *Never try to install all software from folder that is not specified for use with your motherboard.*

2. *The notice of Intel HD audio installation (optional): The Intel High Definition audio functionality unexpectedly quits working in Windows Server 2003 Service Pack 1 or Windows XP Professional x64 Edition. Users need to download and install the update packages from the Microsoft Download Center “before” installing HD audio driver bundled in the Driver disk. Please log on to <http://support.microsoft.com/default.aspx?scid=kb;en-us;901105#appliesto> for more information.*

#### **Auto-installing under Windows XP/Vista/7**

The Auto-install DVD-ROM/CD-ROM makes it easy for you to install the drivers and software for your motherboard.



*If the Auto-install DVD-ROM/CD-ROM does not work on your system, you can still install drivers through the file manager for your OS (for example, Windows Explorer). Refer to the Utility Folder Installation Notes later in this chapter.*

The support software DVD-ROM/CD-ROM disc loads automatically under Windows XP/Vista/7. When you insert the DVD-ROM/CD-ROM disc in the DVD-ROM/CD-ROM drive, the autorun feature will automatically bring up the install screen. The screen has three buttons on it, Setup, Browse CD and Exit.



*If the opening screen does not appear; double-click the file “setup.exe” in the root directory.*

Using the Motherboard Software

### Drivers Tab

<b>Setup</b>	Click the <b>Setup</b> button to run the software installation program. Select from the menu which software you want to install.
<b>Browse CD</b>	<p>The <b>Browse CD</b> button is the standard Windows command that allows you to open Windows Explorer and show the contents of the support disk.</p> <p>Before installing the software from Windows Explorer, look for a file named README.TXT or something similar. This file may contain important information to help you install the software correctly.</p> <p>Some software is installed in separate folders for different operating systems, such as Windows XP/Vista/7. Always go to the correct folder for the kind of OS you are using.</p> <p>In install the software, execute a file named SETUP.EXE by double-clicking the file and then following the instructions on the screen.</p>
<b>Exit</b>	The <b>EXIT</b> button closes the Auto Setup window.

### Utilities Tab

Lists the software utilities that are available on the disk.

### Information Tab

Displays the path for all software and drivers available on the disk.

### Running Setup

Follow these instructions to install device drivers and software for the motherboard:

1. Click **Setup**. The installation program begins:

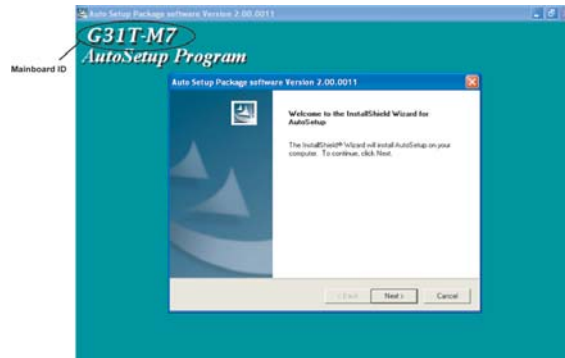

The following screens are examples only. The screens and driver lists will be different according to the motherboard you are installing.

The motherboard identification is located in the upper left-hand corner.

## Using the Motherboard Software



2. Click **Next**. The following screen appears:

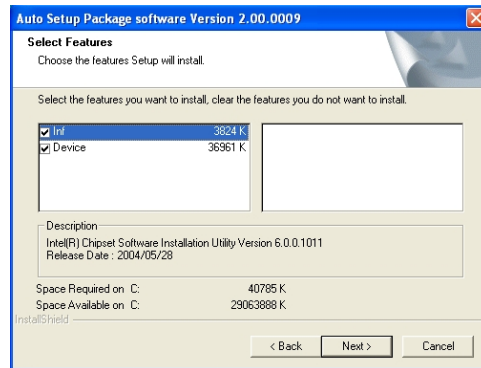

3. Check the box next to the items you want to install. The default options are recommended.
4. Click **Next** run the Installation Wizard. An item installation screen appears:



5. Follow the instructions on the screen to install the items.



Drivers and software are automatically installed in sequence. Follow the onscreen instructions, confirm commands and allow the computer to restart a few times to complete the installation.



Windows Vista/7 will appear below UAC (User Account Control) message after the system restart. You must select “Allow” to install the next driver. Continue this process to complete the drivers installation.

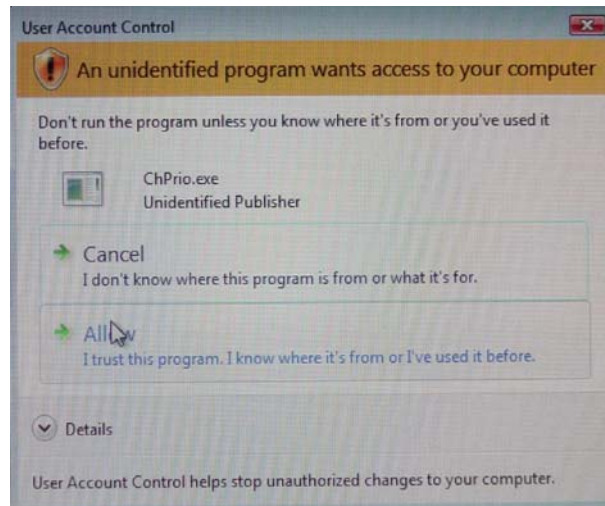

## Manual Installation

Insert the disk in the DVD-ROM/CD-ROM drive and locate the PATH.DOC file in the root directory. This file contains the information needed to locate the drivers for your motherboard.

Look for the chipset and motherboard model; then browse to the directory and path to begin installing the drivers. Most drivers have a setup program (SETUP.EXE) that automatically detects your operating system before installation. Other drivers have the setup program located in the operating system subfolder.

If the driver you want to install does not have a setup program, browse to the operating system subfolder and locate the readme text file (README.TXT or README.DOC) for information on installing the driver or software for your operating system.

## Utility Software Reference

All the utility software available from this page is Windows compliant. They are provided only for the convenience of the customer. The following software is furnished under license and may only be used or copied in accordance with the terms of the license.



*These software(s) are subject to change at anytime without prior notice. Please refer to the support disk for available software.*

This concludes Chapter 4.

## Using the Motherboard Software

## Chapter 5

### ***Trouble Shooting***

---

#### **Start up problems during assembly**

After assembling the PC for the first time you may experience some start up problems. Before calling for technical support or returning for warranty, this chapter may help to address some of the common questions using some basic troubleshooting tips.

##### ***a) System does not power up and the fans are not running.***

1. Disassemble the PC to remove the VGA adaptor card, DDR memory, LAN, USB and other peripherals including keyboard and mouse. Leave only the motherboard, CPU with CPU cooler and power supply connected. Turn on again to see if the CPU and power supply fans are running.
2. Make sure to remove any unused screws or other metal objects such as screwdrivers from the inside PC case. This is to prevent damage from short circuit.
3. Check the CPU FAN connector is connected to the motherboard.
4. For Intel platforms check the pins on the CPU socket for damage or bent. A bent pin may cause failure to boot and sometimes permanent damage from short circuit.
5. Check the 12V power connector is connected to the motherboard.
6. Check that the 12V power & ATX connectors are fully inserted into the motherboard connectors. Make sure the latches of the cable and connector are locked into place.

##### ***b) Power is on, fans are running but there is no display***

1. Make sure the monitor is turned on and the monitor cable is properly connected to the PC.
2. Check the VGA adapter card (if applicable) is inserted properly.
3. Listen for beep sounds. If you are using internal PC speaker make sure it is connected.
  - a. continuous 3 short beeps : memory not detected
  - b. 1 long beep and 8 short beeps : VGA not detected

***c) The PC suddenly shuts down while booting up.***

1. The CPU may experience overheating so it will shutdown to protect itself. Ensure the CPU fan is working properly.
2. From the BIOS setting, try to disable the Smartfan function to let the fan run at default speed. Doing a Load Optimised Default will also disable the Smartfan.

**Start up problems after prolong use**

After a prolong period of use your PC may experience start up problems again. This may be caused by breakdown of devices connected to the motherboard such as HDD, CPU fan, etc. The following tips may help to revive the PC or identify the cause of failure.

1. Clear the CMOS values using the CLR\_CMOS jumper. Refer to CLR\_CMOS jumper in Chapter 2 for Checking Jumper Settings in this user manual. When completed, follow up with a Load Optimised Default in the BIOS setup.
2. Check the CPU cooler fan for dust. Long term accumulation of dust will reduce its effectiveness to cool the processor. Clean the cooler or replace a new one if necessary.
3. Check that the 12V power & ATX connectors are fully inserted into the motherboard connectors. Make sure the latches of the cable and connector are locked into place.
4. Remove the hard drive, optical drive or DDR memory to determine which of these component may be at fault.

**Maintenance and care tips**

Your computer, like any electrical appliance, requires proper care and maintenance. Here are some basic PC care tips to help prolong the life of the motherboard and keep it running as best as it can.

1. Keep your computer in a well ventilated area. Leave some space between the PC and the wall for sufficient airflow.
2. Keep your computer in a cool dry place. Avoid dusty areas, direct sunlight and areas of high moisture content.
3. Routinely clean the CPU cooler fan to remove dust and hair.
4. In places of hot and humid weather you should turn on your computer once every other week to circulate the air and prevent damage from humidity.
5. Add more memory to your computer if possible. This not only speeds up the system but also reduces the loading of your hard drive to prolong its life span.
6. If possible, ensure the power cord has an earth ground pin directly from the wall outlet. This will reduce voltage fluctuation that may damage sensitive devices.

**Trouble Shooting**

## Basic Troubleshooting Flowchart

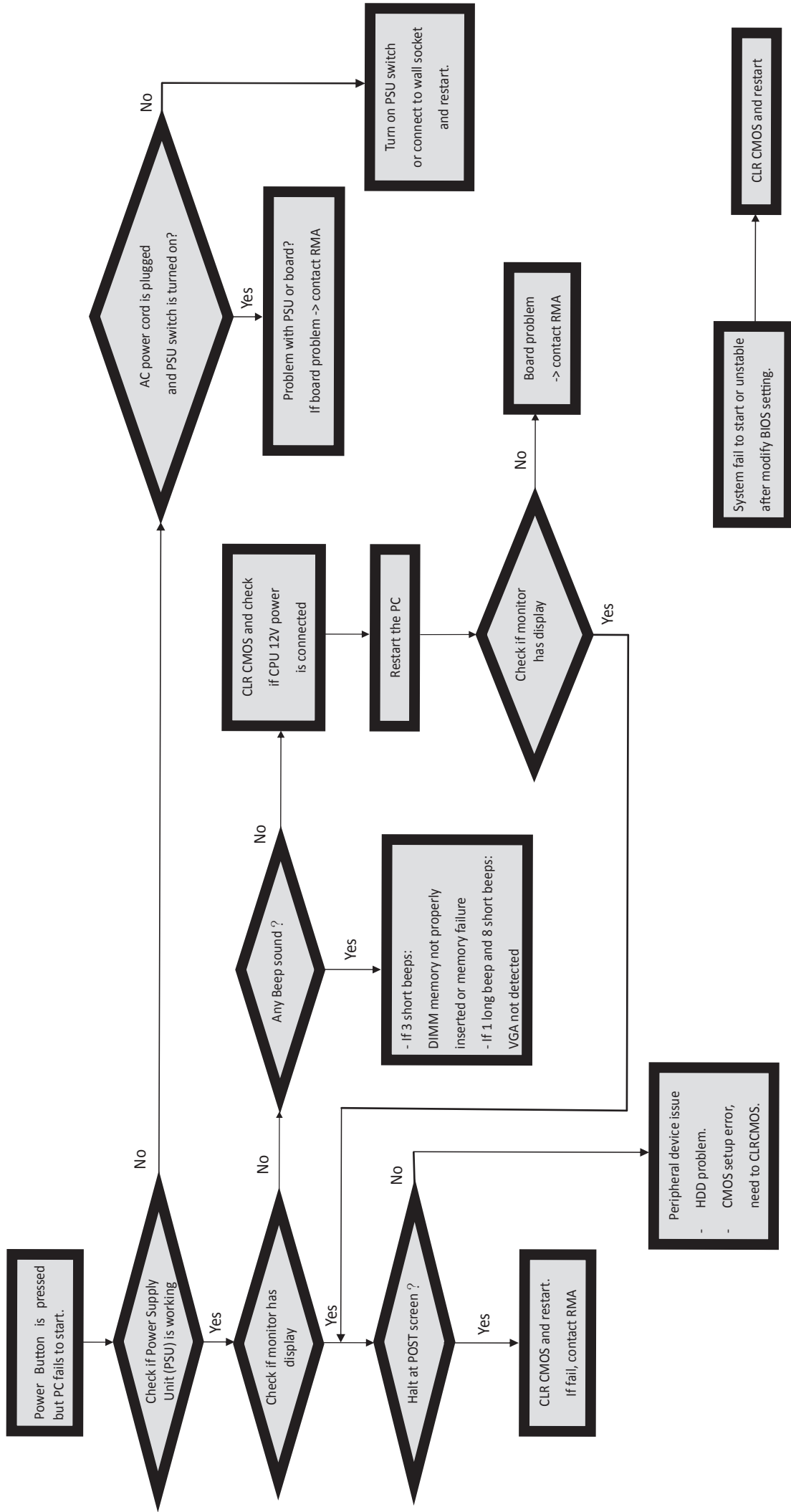

**50**

***Memo***

**Trouble Shooting**