

Super Audio CD Player

Operating Instructions



SCD-CE595

WARNING

To prevent fire or shock hazard, do not expose the unit to rain or moisture.

To avoid electrical shock, do not open the cabinet. Refer servicing to qualified personnel only.

To prevent fire, do not cover the ventilation of the apparatus with news papers, table-cloths, curtains, etc. And don't place lighted candles on the apparatus.

To prevent fire or shock hazard, do not place objects filled with liquids, such as vases, on the apparatus.



Don't throw away the battery with general house waste, dispose of it correctly as chemical waste.

NOTICE FOR THE CUSTOMERS IN THE U.S.A.

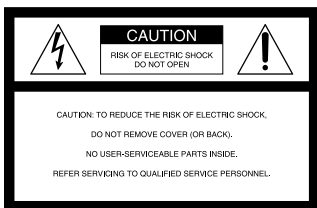

This symbol is intended to alert the user to the presence of uninsulated "dangerous voltage" within the product's enclosure that may be of sufficient magnitude to constitute a risk of electric shock to persons.



This symbol is intended to alert the user to the presence of important operating and maintenance (servicing) instructions in the literature accompanying the appliance.

CAUTION

The use of optical instruments with this product will increase eye hazard.

WARNING

This equipment has been tested and found to comply with the limits for a Class B digital device, pursuant to Part 15 of the FCC Rules. These limits are designed to provide reasonable protection against harmful interference in a residential installation. This equipment generates, uses, and can radiate radio frequency energy and, if not installed and used in accordance with the instructions, may cause harmful interference to radio communications. However, there is no guarantee that interference will not occur in a particular installation. If this equipment does cause harmful interference to radio or television reception, which can be determined by turning the equipment off and on, the user is encouraged to try to correct the interference by one or more of the following measures:

- Reorient or relocate the receiving antenna.
- Increase the separation between the equipment and receiver.
- Connect the equipment into an outlet on a circuit different from that to which the receiver is connected.
- Consult the dealer or an experienced radio/TV technician for help.

CAUTION

You are cautioned that any changes or modifications not expressly approved in this manual could void your authority to operate this equipment.

Owner's Record

The model and serial numbers are located at the rear. Record the serial number in the space provided below. Refer to them whenever you call upon your Sony dealer regarding this product.

Model No. _____

Serial No. _____

NOTICE FOR THE CUSTOMERS IN CANADA

This Class B digital apparatus complies with Canadian ICES-003.

CAUTION

The use of optical instruments with this product will increase eye hazard.

CAUTION

TO PREVENT ELECTRIC SHOCK, MATCH WIDE BLADE OF PLUG TO WIDE SLOT, FULLY INSERT.

Table of Contents

Features of the player	4
Compatible Disc Types	4
About the Super Audio CD	5
<hr/>	
Getting Started	
Inserting batteries into the remote	6
Hooking Up the Audio Components	6
<hr/>	
Playing Discs	
Playing a Disc	9
Using the Display	10
Replacing Discs While Playing a Disc	12
— Ex-Change	
Locating a Particular Point in a Track	13
Playing Tracks Repeatedly	13
— Repeat Play	
Playing Tracks in Random Order	14
— Shuffle Play	
Creating Your Own Program	14
— Program Play	
Enjoying a Multi-channel Super Audio CD	15
— Multi-channel management function	
<hr/>	
Additional Information	
Precautions	20
Notes on Discs	21
Troubleshooting	21
Specifications	22
Index to Parts and Controls	23

Features of the player

This player is designed to play back 2-channel and Multi-channel Super Audio CDs, and conventional CDs, and provides the following features:

- Mounted with a Discrete Dual Laser Optical Pickup, capable of reading a Super Audio CD or conventional CD depending on the exclusive wavelength.
- Quicker track access performance enabled by an advanced servo mechanism.
- A Multi-Channel Management function that allows you to adjust the multi-channel playback environment according to the allocation and size of your speakers.
- A Super Audio D/A Converter, which allows higher-quality sound reproduction.
- A Super Audio CD can mark up to 255 track numbers. This feature applies to SCD-CE595.
- The supplied remote is capable of controlling both the SCD-CE595 and a conventional Sony CD player.

Compatible Disc Types

You can play the following types of discs on this player.

- Super Audio CDs
- Audio CDs

This player cannot play the following discs. If you try to play them, the error message “TOC ERROR” or “NO DISC” will appear.

- CD-ROMs
- DVDs, etc.

Music discs encoded with copyright protection technologies

This product is designed to playback discs that conform to the Compact Disc (CD) standard.

Recently, various music discs encoded with copyright protection technologies are marketed by some record companies. Please be aware that among those discs, there are some that do not conform to the CD standard and may not be playable by this product.

Notes on CD-R/CD-RW playback

Discs recorded on CD-R/CD-RW drives may not be played back because of scratches, dirt, recording condition, or the drive's characteristics. Besides, the discs, which are not yet finalized at the end of recording, cannot be played back. In these cases, “READING” will remain or “TOC ERROR” will appear in the display.

Note on dts-CDs

Do not play a dts-CD on this player. If you do, severe noise will be generated.

About the Super Audio CD

Super Audio CD is a new high-quality audio disc standard where music is recorded in the DSD (Direct Stream Digital) format (conventional CDs are recorded in the PCM format). The DSD format, using a sampling frequency 64 times higher than that of a conventional CD, and with 1-bit quantization, achieves both a wide frequency range and a wide dynamic range across the audible frequency range, and so provides music reproduction extremely faithful to the original sound.

Types of Super Audio CDs

There are two types of discs, depending on the SA-CD layer and CD layer combination.

SA-CD layer: A high-density signal layer for Super Audio CD

CD layer¹⁾: A layer that is readable by a conventional CD player

Single layer disc
(a disc with a single SA-CD layer)



Hybrid disc²⁾
(a disc with an SA-CD layer and a CD layer)

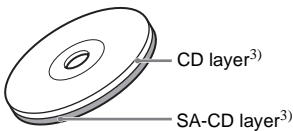

An SA-CD layer consists of the 2 channel area or the multi-channel area.

2 channel area: An area in which 2 channel stereo tracks are recorded

Multi-channel area: An area in which multi-channel (up to 5.1 channels) tracks are recorded

Example:
When the 2 channel area and the multi-channel area are recorded on an SA-CD layer of a hybrid disc

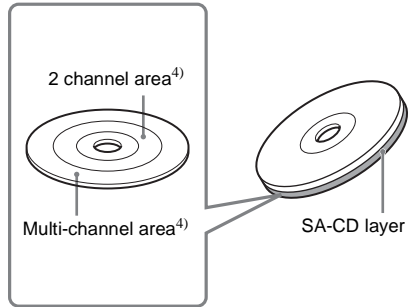

- 1) You can play the CD layer on a conventional CD player.
- 2) Since both layers are on one side, it is not necessary to turn the disc over.
- 3) Press SA-CD/CD to select the layer you want to listen to (see page 9).
- 4) In case of a disc with both areas, press MULTI/2CH to select the area you want to listen to (see page 10).

Getting Started

Inserting batteries into the remote

Insert two R6 (size-AA) batteries into the battery compartment with the + and – correctly oriented to the markings. When using the remote, point it at the remote sensor  on the player.

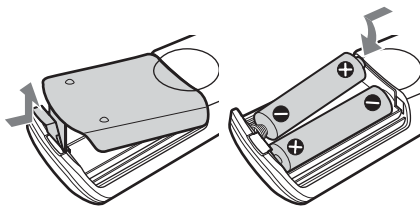

Tip

Under normal conditions, the batteries should last for about six months. When the remote no longer operates the player, replace both batteries with new ones.

Notes

- Do not leave the remote in an extremely hot or a humid place.
- Do not drop any foreign object into the remote casing, particularly when replacing the batteries.
- Do not use a new battery with an old one.
- Do not expose the remote sensor to direct sunlight or lighting apparatus. Doing so may cause a malfunction.
- If you do not intend to use the remote for an extended period of time, remove the batteries to avoid possible damage from battery leakage and corrosion.

Hooking Up the Audio Components

Connect the Super Audio CD player to an audio component. Be sure to turn off the power of all components before making connections and connect securely to prevent noise.

Connecting a multi-channel amplifier

When you have an amplifier equipped with the 5.1CH input jacks (multi-channel amplifier, AV amplifier, etc.) and connect the player and the amplifier through the ANALOG 5.1CH OUT jacks (FRONT L/R, SURR L/R, CENTER, SUB WOOFER), you can play a Multi-channel Super Audio CD and enjoy the multi-channel playback.

Use audio connecting cords for this connection. For FRONT or SURR connection, use the connecting cords (Red and White jacks) and be sure to match the color-coded pin to the appropriate jacks: white (left) to white and red (right) to red. For CENTER and SUB WOOFER connection, use the connecting cords (Black).

FRONT or SURR connection

Audio connecting cords (one cord is supplied)

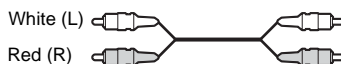

CENTER or SUB WOOFER connection

Audio connecting cords (not supplied)



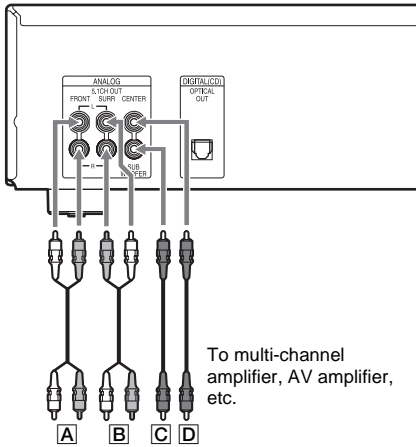

- A:** To front speaker input jacks (L/R)
- B:** To surround or rear speaker input jacks (L/R)
- C:** To sub woofer input jack
- D:** To center speaker input jack

Note

There are 5CH, 4CH, and 3CH Super Audio CD. When you play these discs, the signal does not output from all the jacks of the ANALOG 5.1CH OUT. For details of the playback, see the cover or instructions of the Super Audio CD.

Connecting a stereo amplifier or MD deck

When you connect a stereo amplifier or make an analog connection with an MD deck, connect the player and the component through the ANALOG 5.1CH OUT FRONT L/R jacks. Use an audio connecting cord for this connection. Be sure to match the color-coded pin to the appropriate jacks: white (left) to white and red (right) to red.

Audio connecting cord (supplied)

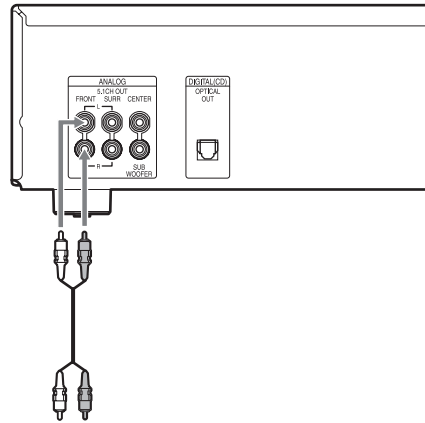
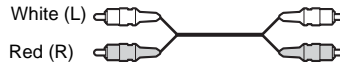

To CD (Super Audio CD) or line input jacks (L/R) on a stereo amplifier, MD deck, etc.

Note

When a disc with the 2 channel area and multi-channel area is played through the ANALOG 5.1CH OUT FRONT L/R jacks, change the default playback area to "SEL-2ch" (2 channel playback area) (see page 10). If you do not, the multi-channel playback area will be automatically played back and only the signal to the front speakers will be output. In this case, the vocals or other sounds may not be heard, depending on the disc.

Connecting a digital component

When you connect an MD deck or another digital component through the DIGITAL (CD) OPTICAL OUT connector, you can make a digital recording.

Use an optical digital cable for this connection. When connecting the optical digital cable to the DIGITAL (CD) OPTICAL OUT connector, push the cable plug in until it clicks into place. Be careful not to bend or twist the optical cable.

Optical digital cable (not supplied)

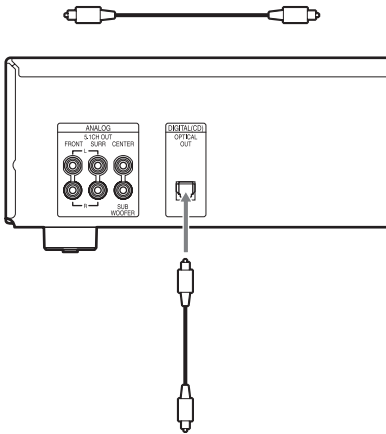

To CD optical digital input connector on an MD deck, etc.

Note

Only the audio signals of conventional CDs can be output from the DIGITAL (CD) OPTICAL OUT connector. Those of the Super Audio CD cannot be output through the DIGITAL (CD) OPTICAL OUT connector.

Connecting the AC power cord

Connect the AC power cord to a wall outlet.

When using another Sony CD player in conjunction with this player

You can set the supplied remote to be effective on this player only by changing the command mode of the remote.

To set the command mode of the remote

- If the other player's command mode can be set:
Set the CD1/2 switch of this player's remote to CD1 (factory setting), and set the other player's remote to CD2.
- If the other player's command mode cannot be set:
Set the CD1/2 switch of this player's remote to CD2.

To set the command mode of this player

- 1 Press MENU on the player.**
- 2 Turn ◀◀ AMS ▶▶ (or press ◀◀/▶▶ on the remote repeatedly) to select "CD1/2 SEL".**
- 3 Press ◀◀ AMS ▶▶ (or ENTER on the remote).**
The current command mode appears.
- 4 Turn ◀◀ AMS ▶▶ (or press ◀◀/▶▶ on the remote) to select "CD - 1" or "CD - 2", then press ◀◀ AMS ▶▶ (or ENTER on the remote).**

Playing Discs

Playing a Disc

The operations for normal play and the basic operations during play are explained below.

- 1 Turn on the amplifier. Turn down the volume level to the lowest.**
- 2 Select the player position using the input selector on the amplifier.**
- 3 Press POWER on the player to turn on the player.**
- 4 Press \triangle OPEN/CLOSE on the player to open the disc tray, and place a disc on the tray.**

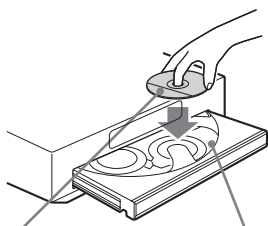

With the label side up

Disc number

- 5 To place other discs, press DISC SKIP (or DISC SKIP +/- on the remote) repeatedly and place the discs in the order you want to play.**

Each time you press the button, the disc tray turns and you can place the discs in the empty disc compartments. The player plays the disc in front of you first.

- 6 Press PLAY MODE (or CONTINUE on the remote) repeatedly to select ALL DISCS or 1DISC Continuous Play mode.**

Each time you press CONTINUE on the remote, "ALL DISCS" or "1 DISC" appears in the display.

When you select	The player plays
ALL DISCS	All discs in the player consecutively in the order of disc number
1DISC	Only the disc you have selected

- 7 Press \triangleright .**

Playback starts from the first track. If you want to start playing from a specific track, turn \lll AMS \ggg (or press \lll / \ggg) on the remote repeatedly) to select the track number before pressing \triangleright .

- 8 Adjust the volume on the amplifier.**

Basic operations during play

To	Do the following:
Stop play	Press \blacksquare .
Pause play	Press \blacksquare .
Resume play after pausing	Press \blacksquare or \triangleright .
Select a track	Turn \lll AMS \ggg (or press \lll / \ggg) on the remote repeatedly).
Select a disc	Press DISC SKIP (or DISC SKIP +/- on the remote) repeatedly. By pressing DISC 1-5 on the player, you can select a specific disc directly.
Eject a disc	Press \triangle OPEN/CLOSE on the player.

Note

During playback, increase the volume level gradually starting from the lowest level. The output from this player may contain band width that is out of the normal listening range. This may cause damage to the speakers or ears.

Selecting the playback layer

When playing a hybrid disc with an SA-CD layer and a CD layer (page 5), you can select the layer you want to listen to. Also, since both layers are on one side, it is not necessary to turn the disc over.

Press SA-CD/CD to select the desired playback layer.

To select the default playback layer

- 1 Press MENU on the player.**
- 2 Turn \lll AMS \ggg (or press \lll / \ggg) on the remote repeatedly) until "LAYER SEL" appears in the display.**

Displaying the information

TEXT discs contain information, such as the disc name or artist name, as well as the audio signals. This player can display the disc name, artist name, and current track name as TEXT information.

When the player detects a TEXT disc, "TEXT" appears in the display. If your TEXT disc has several languages, "MULTI-TEXT" appears in the display. When you want to check the information in another language, see "Displaying the information of a TEXT disc in other languages" on page 12.

If a name has 13 or more characters, the first 12 characters will remain after the name scrolls by in the display.

Before you start playing

Press TIME/TEXT repeatedly.

Each time you press the button, the disc name or artist name appears in the display. When you select the artist name, "ART." appears in the display.

Disc title*



Artist name*



Total number of tracks and total playing time

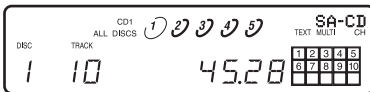

* Only for TEXT discs

While playing a disc

Press TIME/TEXT repeatedly.

When the player detects a Multi-channel Super Audio CD, the channel information appears for a few seconds after the track title appears.

Playing time of the current track



Remaining time of the current track



Remaining time of the disc¹⁾

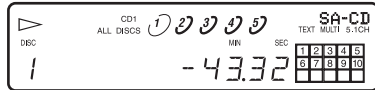

Track title²⁾

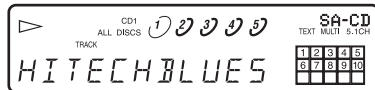

Channel information (appears only when the player detects a Multi-channel Super Audio CD)

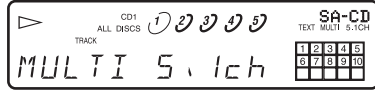

¹⁾ Only when Continuous Play is selected

²⁾ Only for TEXT discs

Notes

- The display may not show all the characters, depending on the disc.
- This player can display only the disc name, artist name, and track names from TEXT discs. Other information cannot be displayed.

Turning off the information in the display

Press DISPLAY MODE on the remote.

Each time you press the button while playing a disc, the display turns off and on alternately. Even when the display is turned off, it will turn on when certain buttons are pressed, and then turn off again after a few seconds.

Before you start playing, when you press the button to turn off the display, "DISP OFF" appears, and when you press the button to turn on the display, "DISP ON" appears.

Displaying the information of a TEXT disc in other languages

You can change the displayed language if the TEXT disc has multi language capacity. When the player detects such a TEXT disc, "MULTI-TEXT" appears in the display. Change the language according to the procedures below.

- 1 Press MENU on the player.**
- 2 Turn ◀◀ AMS ▶▶ (or press ◀◀ / ▶▶ on the remote repeatedly) until "LANGUAGE" appears in the display.**
- 3 Press ◀◀ AMS ▶▶ (or ENTER on the remote).**

The current selected language (ENGLISH, FRENCH, GERMAN, etc.) flashes.

If the player cannot display the language used in a TEXT disc, "OTHER LANG" appears in the display.

- 4 Turn ◀◀ AMS ▶▶ (or press ◀◀ / ▶▶ on the remote repeatedly) until the desired language appears in the display.**
- 5 Press ◀◀ AMS ▶▶ (or ENTER on the remote).**

After a few seconds, the information appears in the selected language.

Replacing Discs While Playing a Disc

— Ex-Change

You can open the disc tray while playing a disc so that you can check what discs are to be played next and replace discs without interrupting play of the current disc.

- 1 Press EX-CHANGE on the player.**

The disc tray opens and two disc compartments appear. Even if the player is playing a disc, it does not stop playing.
- 2 Replace discs in the compartments with new ones.**

The player plays the disc on the left side compartment after the current disc, and then the one on the right side compartment.
- 3 Press DISC SKIP (or DISC SKIP +/- on the remote).**

The disc tray turns and other two disc compartments appear.
- 4 Replace discs in the compartments with new ones.**
- 5 Press EX-CHANGE on the player.**

The disc tray closes.

Note

Do not push the disc tray to close it in Step 5, as you may damage the player.

While the disc tray is open by pressing EX-CHANGE on the player

- If the play of the current disc ends, the player stops playing. If the disc is played in 1DISC Repeat Play mode (page 13), the current disc starts playing again.
- In ALL DISCS Shuffle Play mode (page 14), tracks are reshuffled on the current disc.
- In Program Play mode (page 14), only the tracks on the current disc are played.

Locating a Particular Point in a Track

You can locate a particular point in a track during play or play pause.

Locating a point	Do the following:
While monitoring the sound (Search)	Press and hold ◀◀/▶▶ during play.
By observing the time indication (High-Speed Search)	Press and hold ◀◀/▶▶ during play pause.
By setting the start time (Time Search)	<ol style="list-style-type: none"> Turn ◀◀ AMS ▶▶ (or press ◀◀/▶▶) on the remote repeatedly) in stop mode to select the desired track. Press and hold ◀◀/▶▶ to set the time to start play while looking at the display, then press ▷.

Tip

When “OVER” appears in the display, the disc has reached its end. Press and hold ◀◀ to go back.

Note

Tracks that are only a few seconds long may be too short for monitoring. In this case, the player may not search correctly.

Playing Tracks Repeatedly

— Repeat Play

You can play an entire disc or a specific track repeatedly. This function can be used with 1DISC Shuffle Play to repeat all the tracks in random order (page 14), or with Program Play to repeat all the tracks in a program (page 14).

Press REPEAT on the remote repeatedly until “REP” or “REP1” appears in the display.

REP: For all the tracks on the disc(s).

REP1: For a single track only.

When “REP” is selected, Repeat Play changes according to the selected play mode.

When the play mode is	The player repeats
ALL DISCS Continuous Play (page 9)	All the tracks on all the discs in sequential order.
1DISC Continuous Play (page 9)	All the tracks on the current disc in sequential order.
1DISC Shuffle Play (page 14)	All the tracks on the current disc in random order.
Program Play (page 14)	All the tracks in the program in sequential order.

To cancel Repeat Play

Press REPEAT on the remote repeatedly until both “REP” and “REP1” disappear.

Notes

- Repeat All Play cannot be used with ALL DISCS Shuffle Play.
- Repeat All Play stops automatically after all the tracks have been repeated five times.
- If you turn off the player or disconnect the power cord, Repeat Play is canceled.

Playing Tracks in Random Order

— Shuffle Play

When Shuffle Play is selected, the player will play all the tracks on all the discs or on a specific disc in random order.

Shuffle Play on all discs

You can play all the tracks on all the discs in random order.

- 1 Press PLAY MODE (or SHUFFLE on the remote) repeatedly in stop mode until “ALL DISCS” and “SHUF” appear in the display.**
- 2 Press ▷.**
“” appears while the player is “shuffling” the tracks. The player will stop after playing all the tracks once.

Shuffle Play on one disc

You can play all the tracks on a specific disc in random order.

- 1 Press PLAY MODE (or SHUFFLE on the remote) repeatedly in stop mode until “1DISC” and “SHUF” appear in the display.**
- 2 Press DISC 1-5 on the player.**
“” appears while the player is “shuffling” the tracks. The player will stop after playing all the tracks once.

To resume Continuous Play

Press PLAY MODE repeatedly (or CONTINUE on the remote) in stop mode until “SHUF” and “PGM” disappear.







Note

The player does not go back to tracks which have already been played.

Creating Your Own Program

— Program Play

You can pick out the tracks that you like and specify the playback order in a program containing up to 32 steps.

- 1 Press PLAY MODE repeatedly (or PROGRAM on the remote) in stop mode until “PGM” appears in the display.**
- 2 Press DISC 1-5 on the player.**
The selected disc number appears in the display.
You can also select the desired disc number by pressing DISC SKIP (or DISC SKIP +/- on the remote) repeatedly.
To program all the tracks on a disc at once, proceed to Step 4 with “AL” displayed.
- 3 Turn  << AMS >>  (or press  / ) on the remote repeatedly) to select the desired track number.**
- 4 Press  << AMS >>  (or ENTER on the remote).**
If you entered the wrong track number
Press CLEAR on the remote. Then repeat Steps 3 and 4 to enter the correct track number.
- 5 Repeat Steps 2 through 4 to enter other tracks.**
Each time you enter a track number, the total number of program steps appears in the display.
- 6 Press ▷.**
Program Play starts.

To resume Continuous Play

Press PLAY MODE repeatedly (or CONTINUE on the remote) in stop mode until “SHUF” and “PGM” disappear.

Tip

The program remains even after Program Play ends. Press ▷ to play from the beginning of the program again. The program remains even if you stop play.

Notes

- If you turn off the player, disconnect the power cord, press OPEN/CLOSE on the player, or switch the playback layer or area, the program will be erased.
- If you switch the playback layer or area during Program Play, a single track only will be played back from its beginning, and then the program will be erased.

Checking the contents of the program

Before you start playing or while the player is playing, press CHECK on the remote repeatedly.

Each time you press the button, the disc and track numbers will appear in the display in the programmed order.

If you press CHECK on the remote while the player is playing, the programmed disc and track numbers will appear starting with the currently playing program step.

Changing the contents of the program

You can change the contents of the program in stop mode.

To	Do the following:
Erase a track	<ol style="list-style-type: none"> 1 Press CHECK on the remote repeatedly until the track number you want to erase appears. 2 Press CLEAR on the remote.
Erase from the last track in the program	<p>Press CLEAR on the remote.</p> <p>Each time you press the button, the last track of the program is erased.</p>
Add a track to the end of the program	Perform Steps 2 through 4.
Erase all tracks	Hold down CLEAR on the remote or \blacksquare (for about 2 seconds) until "PGM CLEAR" appears in the display.

Enjoying a Multi-channel Super Audio CD

— Multi-channel management function

This player is equipped with a Multi-channel management function that sets the playback mode of the Super Audio CD by the DSD-DSP (built into the player) according to the layout or size of your speaker.

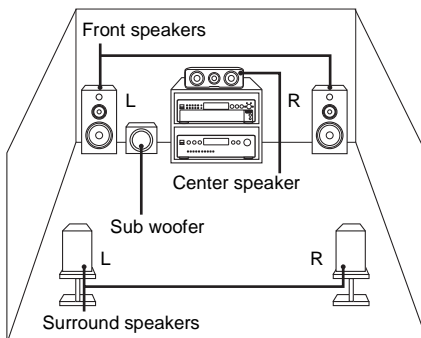

To set the Multi-channel management function, select the appropriate preset playback mode (2 channel mode or Multi-channel mode), and then adjust the output level balance for each speaker (only in the case of Multi-channel mode).

Notes

- This features only work when you play the Super Audio CD.
- You may not be able to adjust the output level balance depending on the speaker layout mode that you selected.

Selecting the playback mode

- 1 Press **MENU** on the player.
- 2 Turn **◀◀ AMS ▶▶** (or press **◀◀ / ▶▶** on the remote repeatedly) until the desired channel mode appears in the display.

2chSP MODE: To play a 2 channel Super Audio CD.

MchSP MODE: To play a Multi-channel Super Audio CD.

- 3 Press **◀◀ AMS ▶▶** (or **ENTER** on the remote).

The playback mode appears in the display.

- 4 Turn **◀◀ AMS ▶▶** (or press **◀◀ / ▶▶** on the remote repeatedly) until the desired playback mode appears in the display.

In 2 channel mode

Playback mode	F	SW
2ch DIRECT*	○	—
2ch+SW	○	○

In Multi-channel mode

Playback mode	F	C	SR	SW
Mch DIRECT*	○	○	○	○
5-LARGE+SW	L	L	L	○
5-LARGE	L	L	L	—
5-SMALL+SW	S	S	S	○
F-LARGE+SW	L	S	S	○
F-LARGE	L	S	S	—
NO-CNTR+SW	L	—	L	○
NO-CNTR	L	—	L	—

* Each signal outputs directly from each speaker.

Explanation of table symbols

F: Front speakers

C: Center speaker

SR: Surround speakers

SW: Sub woofer

○: Signal is output

—: Signal is not output

L: Large

S: Small

About “Large” or “Small” speaker

An “L” speaker is a speaker that can reproduce bass frequencies plentifully. If you select “S” for the surround speakers, the bass frequencies will come from the front speakers and/or sub woofer.

For normal use, select “Mch DIRECT” or set all the speakers to “L” (ex. “5-LARGE+SW”, “5-LARGE”, etc.). If the sound is noisy or the Multi-channel playback is not effective while playing a Multi-channel Super Audio CD, change the settings of the speakers concerned to “S”.

- 5 Press **◀◀ AMS ▶▶** (or **ENTER** on the remote).

To return to the normal display, press **MENU** on the player.

Notes

- The Multi-channel management function does not work when you select “Mch DIRECT” (you cannot set the output level balance of each speaker).
 - The front speaker setting is set to “L” automatically when you set the sub woofer to “—”.
 - When you play a track that does not contain the LFE* signal, the signal for the sub woofer does not output. Therefore, when you select “Mch DIRECT”, “5-LARGE+SW”, or “NO-CNTR+SW”, no signal outputs from the sub woofer. However, when you select “5-SMALL+SW” or “F-LARGE+SW” (when you set the speaker setting to “S”), the bass frequencies will come from the sub woofer.
- * Low Frequency Enhancement (described as “.1 CH”)
- If you select a playback mode other than “2ch DIRECT” or “Mch DIRECT” using the Multi-channel management function, the sound distribution to the speakers will change, possibly causing a decrease in overall sound volume. If this occurs, adjust the volume with the volume control on the connected amplifier.
 - If you change the playback mode while the player is in Multi-channel mode, the output level balance settings will be canceled.
 - This function cannot be used during CD playback.

Adjusting the output level balance of each speaker

You can adjust the following items in the case of Multi-channel mode:

SURR BAL

The relative output level balance between the front speakers (FRONT L/R) and the surround speakers (SURR L/R)

CNTR BAL

The relative output level balance between the front speakers (FRONT L/R) and the center speaker (CENTER)

SW BAL

The relative output level balance between the front speakers (FRONT L/R) and the sub woofer (SUB WOOFER)

Notes

- Some adjustment may not work depending on the Multi-channel mode that you selected.
- You cannot adjust the speaker level when “Mch DIRECT” is selected.

To adjust the output level balance on the front panel of the player

You can adjust the output level balance of each speaker while listening during playback. You can also adjust it while listening to the test tone during stop mode.

- 1 Press MENU.**
- 2 Turn \lll AMS \ggg until “LEVEL ADJ” appears in the display.**
- 3 Press \lll AMS \ggg .**
During playback, go to Step 6.
- 4 Turn \lll AMS \ggg until “TONE ON” appears in the display.**
- 5 Press \lll AMS \ggg .**
The test tone issues from the speakers in sequence with the speaker type appearing in the display.
- 6 Turn \lll AMS \ggg until the desired item appears in the display.**
Select the item from “SURR BAL”, “CNTR BAL”, or “SW BAL”.

Note

When you set the sub woofer to “—” in the Multi-channel mode (page 16), “SW BAL” cannot be adjusted (“NOT IN USE” appears). Similarly, “CNTR BAL” or “SURR BAL” cannot be adjusted (“NOT IN USE” appears) when you set the corresponding speaker to “—”.

- 7 Press \lll AMS \ggg .**

The balance adjustment display appears.

In stop mode, the test tone is output from the selected speaker.

Example:

When you select “SURR BAL” during stop mode, the test tone is output from the front speakers and surround speakers.

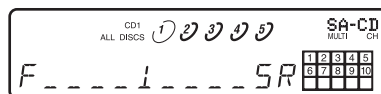

- 8 Turn \lll AMS \ggg to adjust the output level.**

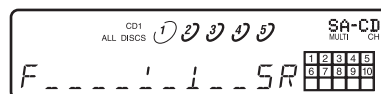

Note

The output level balance can be adjusted in up to 24 steps. Since fine adjustments can be made, it may be difficult to observe the movement of needle.

- 9 Press \lll AMS \ggg .**

The player status returns to Step 6.

Repeat Steps 6 through 9 for more adjustments.

- 10 Press MENU after you finish adjusting.**

The display returns to the normal display.

To adjust the output level from the remote

You can adjust the output level of each speaker from the listening position by using the supplied remote.

- 1 Press LEVEL ADJ during playback or stop mode.**

During playback, go to Step 4.

2 Press **◀◀/▶▶** repeatedly until **“TONE ON”** appears in the display.

3 Press **ENTER**.

The test tone issues from the speakers in sequence with the speaker type appearing in the display.

4 Press **◀◀/▶▶** repeatedly until the desired item appears in the display.

Select the item from **“SURR BAL”**, **“CNTR BAL”**, or **“SW BAL”**.

Note

When you set the sub woofer to **“—”** in the Multi-channel mode (page 16), **“SW BAL”** cannot be adjusted (**“NOT IN USE”** appears). Similarly, **“CNTR BAL”** or **“SURR BAL”** cannot be adjusted (**“NOT IN USE”** appears) when you set the corresponding speaker to **“—”**.

5 Press **ENTER**.

The balance adjustment display appears.

In stop mode, the test tone is output from the selected speaker.

Example:

When you select **“SURR BAL”** during stop mode, the test tone is output from the front speakers and surround speakers.

6 Press **◀◀/▶▶** repeatedly to adjust the output level.

Note

The output level balance can be adjusted in up to 24 steps. Since fine adjustments can be made, it may be difficult to observe the movement of needle.

7 Press **ENTER**.

The player status returns to Step 4.

Repeat Steps 4 through 7 for more adjustments.

8 Press **LEVEL ADJ** after you finish adjusting.

The display returns to the normal display.

Adjusting the speaker distance

You can adjust the speaker distance when the connected amplifier does not have the setting menu for speaker distance. If the amplifier has this function, we recommend that you set the speaker distance on the amplifier. This setting is available only for the Multi-channel Super Audio CD.

Note

When you set the speaker distance on this player and the amplifier, both of the setting may work and you may not be able to get the proper result.

FRT DIST

The distance from your listening position to the front speakers

You can adjust from 3 to 23 feet (1.0 meter to 7.0 meters) in 1 foot (0.1 meter) steps.

If both front speakers are not placed an equal distance from your listening position, set the distance to the closest speaker.

SURR DIST

The distance from your listening position to the surround speakers

You can adjust from 3 to 23 feet (1.0 meter to 7.0 meters) in 1 foot (0.1 meter) steps.

If both surround speakers are not placed an equal distance from your listening position, set the distance to the closest speaker.

CNTR DIST

The distance from your listening position to the center speaker

You can adjust from 3 to 23 feet (1.0 meter to 7.0 meters) in 1 foot (0.1 meter) steps.

SW DIST

The distance from your listening position to the sub woofer

You can adjust from 3 to 23 feet (1.0 meter to 7.0 meters) in 1 foot (0.1 meter) steps.

DIST UNIT

The unit of measure for setting distances (meter or feet)

The initial setting is **“SEL- FEET”** for the North American model and **“SEL- METER”** for the European model.

Note

Speaker distance cannot be adjusted in the following cases.

- When the player is reading the disc information of CD (or the CD area of Super Audio CD)
- When the player is reading the 2 channel area of Super Audio CD

- 1 Press MENU on the player.**
- 2 Turn ◀◀ AMS ▶▶ (or press ◀◀/▶▶ on the remote repeatedly) until "SPK DIST" appears in the display.**
- 3 Press ◀◀ AMS ▶▶ (or ENTER on the remote).**
- 4 Turn ◀◀ AMS ▶▶ (or press ◀◀/▶▶ on the remote repeatedly) until the desired item appears in the display.**

Select the item from "FRT DIST", "SURR DIST", "CNTR DIST" or "SW DIST".

Note

When you set the sub woofer to "—" in the Multi-channel mode (page 16), "SW DIST" cannot be adjusted ("NOT IN USE" appears). Similarly, "CNTR DIST" cannot be adjusted ("NOT IN USE" appears) when you set the center speaker to "—".

- 5 Press ◀◀ AMS ▶▶ (or ENTER on the remote).**

The speaker distance adjustment display appears.

Example:

When you select "SURR DIST" (with "DIST UNIT" set to "SEL-FEET").



- 6 Turn ◀◀ AMS ▶▶ (or press ◀◀/▶▶ on the remote repeatedly) to adjust the speaker distance.**



- 7 Press ◀◀ AMS ▶▶ (or ENTER on the remote).**

The player status returns to Step 4. Repeat Steps 4 through 7 for more adjustments.

- 8 Press MENU on the player after you finish adjusting.**

The display returns to the normal display.

Selecting the distance unit

In Step 4 above, select "DIST UNIT".

Turn ◀◀ AMS ▶▶ (or press ◀◀/▶▶ on the remote) to select "SEL-METER" or "SEL-FEET", then press ◀◀ AMS ▶▶ (or ENTER on the remote).

Setting speaker distances back to the default

Set all speaker distances to 10 feet (3 meters).

Additional Information

Precautions

On safety

- Caution – The use of optical instruments with this product will increase eye hazard.
- Should any solid object or liquid fall into the cabinet, unplug the player and have it checked by qualified personnel before operating it any further.
- AC power cord must be changed only at the qualified service shop.
- The unit is not disconnected from the AC power source (mains) as long as it is connected to the wall outlet, even if the unit itself has been turned off.

On power sources

- Before operating the player, check that the operating voltage of the player is identical with your local power supply. The operating voltage is indicated on the nameplate at the rear of the player.
- The player is not disconnected from the mains as long as it is attached to the mains, even if the player itself has been turned off.
- If you are not going to use the player for a long time, be sure to disconnect the player from the mains. To disconnect the mains lead, grasp the plug itself; never pull the cord.

On placement

- Place the player in a location with adequate ventilation to prevent heat build-up in the player.
- Do not place the player on a soft surface such as a rug that might block the ventilation holes on the bottom.
- Do not place the player in a location near heat sources, or in a place subject to direct sunlight, excessive dust or mechanical shock.

On operation

- If the player is brought directly from a cold to a warm location, or is placed in a very damp room, moisture may condense on the lenses inside the player. Should this occur, the player may not operate properly. In this case, remove the disc and leave the player turned on for about an hour until the moisture evaporates.
- During power on, some noise may be heard while the disc is being loaded into the Super Audio CD player. This is not a malfunction.

On adjusting the volume

Do not turn up the volume too much while listening to a portion with very low level inputs or no audio signals. If you do, the speakers may be damaged when a peak level portion is played.

On inserting a disc

You may hear a transmission or a mechanical sound from the player. This indicates that the player is automatically adjusting its internal mechanisms according to the inserted disc.

You may also hear the mechanical sound from the player when you insert a warped disc.

On cleaning

Clean the cabinet, panel, and controls with a soft cloth slightly moistened with a mild detergent solution. Do not use any type of abrasive pad, scouring powder, or solvent such as alcohol or benzine.

On transportation

- Be sure to remove the discs on the tray.
- Be sure to close the disc tray.

If you have any questions or problems concerning your player, please consult your nearest Sony dealer.

Notes on Discs

On handling discs

- To keep the disc clean, handle the disc by its edge. Do not touch the surface.
- Do not stick paper or tape on the disc.



- Use only round-shaped discs. If you use a special shaped disc (e.g., star-shaped, heart-shaped, or square-shaped, etc.), the player may be damaged.
- Do not use a disc with a seal attached on such as on a used disc or rental disc.

On keeping discs

- Do not expose the disc to direct sunlight or heat sources such as hot air ducts.
- After playing, store the disc in its case. If you put it on top of another disc without the case, the disc may be damaged.

On placing discs on the disc tray

Make sure the disc is positioned securely on the tray. If not, the player or the disc may be damaged.

On cleaning

- If the disc is dirty with fingerprints or dust, it may lessen the quality of the audio out.
- Before playing, clean the disc with a cleaning cloth. Wipe the disc from the center out.



- Clean the disc with a soft cloth slightly moistened with water, and remove moisture with a dry cloth.
- Do not use solvents such as benzine, thinner, record cleaners, or anti-static spray.

Troubleshooting

If you experience any of the following difficulties while using the player, use this troubleshooting guide to help you remedy the problem. Should any problem persist, consult your nearest Sony dealer.

There is no sound.

- Check that the player is connected securely.
- Make sure you operate the amplifier correctly.

There is no sound from the DIGITAL (CD) OPTICAL OUT connector.

- The audio signals of the Super Audio CD cannot be output from the DIGITAL (CD) OPTICAL OUT connector.

The disc does not play.

- There is no disc inside the player.
- Place the disc on the disc tray with the label side up.
- The disc is placed at an angle. Reload the disc.
- Clean the disc (see page 21).
- Moisture has condensed inside the player. Remove the disc and leave the player turned on for about an hour.
- There is an incompatible disc on the tray (see page 4).

The remote does not function.

- Remove any obstacles in the path of the remote and the player.
- Point the remote at the remote sensor on the player.
- If the batteries in the remote are weak, replace with new ones.
- Be sure that the command mode of the remote (position of the CD1/2 switch) (page 24) matches the command mode of the player (page 8).

There is no sound from the SUB WOOFER jack.

- Select a playback mode in which the sub woofer signal is output from the SUB WOOFER jack. The mode indication is displayed with "+ SW" (page 16) when such a mode is selected.
- When you play a track that does not contain the LFE signal, the signal outputs from the SUB WOOFER jack only when you select "5-SMALL+SW" or "F-LARGE+SW" for Multi-channel mode (page 16).

A disc cannot be ejected and “LOCKED” appears in the front panel display.

- Contact your Sony dealer or local authorized Sony service facility.

“REMOVE” is displayed in the front panel display.

- Remove the disc in front of you and turn off the player once, and then turn it on again.
-

After you have attempted the prescribed corrective actions

If the player still does not operate properly, or if other problems not described above occur, turn off the player, unplug it from the power outlet for a few minutes, then reinsert the plug into the power outlet.

Specifications

When a Super Audio CD is played

Playing frequency range	2 Hz to 100 kHz
Frequency response	2 Hz to 40 kHz (–3 dB)
Dynamic range	100 dB or more
Total harmonic distortion rate	

0.0035 % or less

Wow and flutter	Value of measurable limit (±0.001 % W. PEAK) or less
-----------------	--

When a CD is played

Frequency response	2 Hz to 20 kHz
Dynamic range	96 dB or more
Total harmonic distortion rate	

0.0039 % or less

Wow and flutter	Value of measurable limit (±0.001 % W. PEAK) or less
-----------------	--

Output connector

	Jack type	Output level	Load impedance
ANALOG 5.1CH OUT	Phono jacks	2 Vrms (at 50 kilohms)	Over 10 kilohms
DIGITAL (CD)	Square optical output	–18 dBm	(Light emitting wave length: 660 nm)

* Output only the audio signals of the CD

General

Laser	Semiconductor laser (Super Audio CD: $\lambda = 650$ nm) (CD: $\lambda = 780$ nm) Emission duration: continuous
Power requirements	120 V AC, 60 Hz
Power consumption	15 W
Dimensions (w/h/d)	430 × 110 × 420 mm incl. projecting parts
Mass (approx.)	5.5 kg

Supplied accessories

Audio connecting cord	Red and White × 2 (1)
Remote commander	RM-SX800 (1)
Battery	R6 (size-AA) (2)

Design and specifications are subject to change without notice.

Index to Parts and Controls

Further details are provided on the pages indicated in parentheses.

Instructions in this manual describe the controls on the player. You can also use the controls on the remote if they have the same or similar names as those on the player.

Front Panel

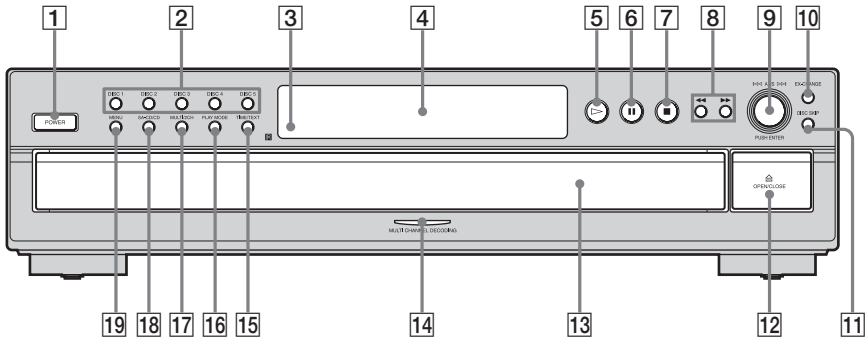

- 1 POWER switch (9)**
- 2 DISC 1-5 buttons (9, 14)**
Press to select the disc directly.
- 3 Remote sensor (6)**
- 4 Display window (10)**
- 5 ▷ button (9, 13, 14)**
- 6 || button (9)**
- 7 ■ button (9, 15)**
- 8 ◀▶ buttons (13)**
- 9 ◀◀ AMS ▶▶ dial
(AMS: Automatic Music Sensor) (8, 9, 10, 12, 13, 14, 16, 17, 19)**
- 10 EX-CHANGE button (12)**
Press to replace discs while playing a disc.
- 11 DISC SKIP button (9, 12, 14)**
Press to select the disc.
- 12 ≡ OPEN/CLOSE button (9)**
- 13 Disc tray (9)**
- 14 MULTI CHANNEL DECODING indicator**
Turns on when you turn on the player, or when the Multi-channel Super Audio CD is loaded and select the multi-channel playback area by pressing MULTI/2CH.
- 15 TIME/TEXT button (11)**
Each time you press the button, the playing time of the track, the remaining time of the disc, or TEXT information appears in the display.
- 16 PLAY MODE button (9, 14)**
Press to select the play mode.
- 17 MULTI/2CH button (5, 10)**
Press to select the playback area when a disc with the 2 channel area and the multi-channel area (page 5) is loaded.
- 18 SA-CD/CD button (5, 9)**
Each time you press the button while playing back a hybrid disc, the layer to be played back switches between the SA-CD layer and the CD layer.
- 19 MENU button (8, 9, 10, 12, 16, 17, 19)**
Press to enter the menu.
Press to exit from the menu and return to the normal display.

Remote

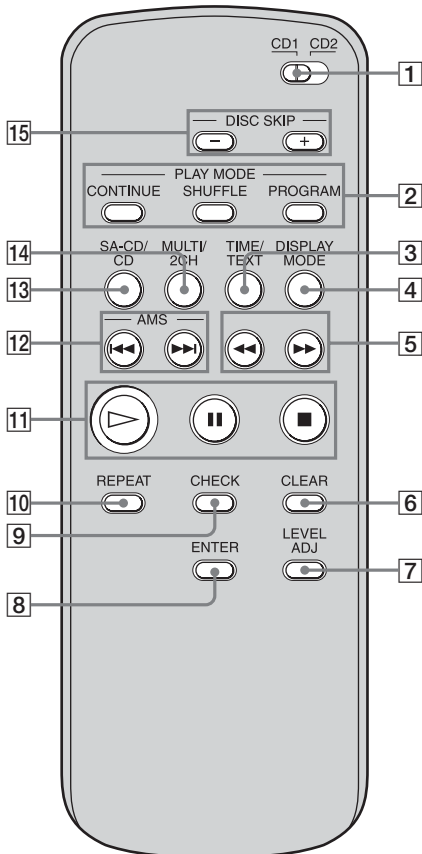

- 1 CD1/2 (command mode) switch (8)**
Select the command mode.
- 2 CONTINUE button (9, 14)**
Press to resume Continuous Play from Shuffle Play or Program Play.
SHUFFLE button (14)
PROGRAM button (14)
- 3 TIME/TEXT button (11)**
Each time you press the button, the playing time of the track, the remaining time of the disc, or TEXT information appears in the display.
- 4 DISPLAY MODE button (12)**
Press to turn the display information off or on.
- 5 ◀◀/▶▶ buttons (13)**
- 6 CLEAR button (14, 15)**
Press to delete a programmed track number.
- 7 LEVEL ADJ button (17)**
Press to adjust the output level balance for the Multi-channel management function (page 15).
- 8 ENTER button (8, 10, 12, 14, 16, 18, 19)**
- 9 CHECK button (15)**
Press to check the programmed order.
- 10 REPEAT button (13)**
- 11 ▷ button (9, 13, 14)**
|| button (9)
■ button (9, 15)
- 12 AMS I◀◀/▶▶I buttons (AMS: Automatic Music Sensor) (8, 9, 10, 12, 13, 14, 16, 18, 19)**
- 13 SA-CD/CD button (5, 9)**
Each time you press the button while playing back a hybrid disc, the layer to be played back switches between the SA-CD layer and the CD layer.
- 14 MULTI/2CH button (5, 10)**
Press to select the playback area when a disc with the 2 channel area and the multi-channel area (page 5) is loaded.
- 15 DISC SKIP +/- buttons (9, 12, 14)**
Press to select the disc.