

FL 2002 - 2 B

Halogen light generator for Fibre optic lighting systems

User Manual



These mounting instructions describes mounting and installation of the following products:

Item no.:	0121 0100	FL 2002-2 B Ø28 100W 230V
	0121 0101	FL 2002-2 B Ø9/Ø28 75W 230V
	0121 0110	FL 2002-2 B Ø28 100W 120V
	0121 0111	FL 2002-2 B Ø9/Ø28 75W 120V

1. Introduction

This manual serves you as a guideline to how the system is operated in the safest way. Following the recommendations in this guideline all contributes to:

- Enhanced functionality
- Extended lifetime of components
- Uninterrupted illumination

Your Roblon halogen light generator, type FL 2002-2 B is intended for indoor use in fibre optic lighting systems using either glass and PMMA fibres. This light generator is prepared for use in cabinets or showcases, either closed or semi closed compartments.

Contents

1. INTRODUCTION	2
2. PRODUCT OVERVIEW AND PACKING LIST	3
3. TECHNICAL INFO.....	3
4. INSTALLING THE LIGHT GENERATOR	4
5. FIXATING THE LIGHT GENERATOR TO THE SURFACE	4
6. MOUNTING OF OPTIONAL COLOUR FILTERS.	5
7. TROUBLE SHOOTING	5
8. SPARE PARTS	7
9. ACCESSORIES	7

2. Product overview and packing list

Contents of this box:

- FL 2002-2 B
- Adaptor kit Ø28 -> Ø9 (including allen key)
- User manual



3. Technical info

Light port size:	Ø28 mm. Ø9 focus with the supplied adapter
Fibre type:	PMMA/Glass
Supply voltage:	230-240 V / 50-60 Hz or 120 V / 60 Hz
Lamps:	75W Philips type 14515, 3000K. 100W Philips type 6839/25H. 3400K.
Power consumption:	75 W 69 VA 100 W 96 VA
Power cord:	Power cord
Dimming:	Leading or trailing edge.
Ballast:	Electronic
Thermal protection:	Yes, w/ auto reset.
Cooling system:	12 VDC axial fan (60x60mm)
Fan noise level:	29 db(A)
Ambient temperature:	0 - 40 °C
Lamp type:	Halogen
Lamp life time:	75W 6000 hours 100W 2500 hours
Lamp colour temp:	75W 3000K 100W 3400K
Material:	Anodised aluminium.
Dimensions:	(L x H x W) 195 x 85 x 70mm.
Weight:	600 g.
Safety approvals:	CE CB cUL _{us}

4. Installing the Light generator

1. Mount the $\varnothing 9/\varnothing 28$ adapter on the harness common end.
 2. Secure the set screw with the supplied allen key.
 3. Insert the harness' common end fully into the light port on the light generator.
 4. Tighten the finger screw at the light port.
 5. Close the lid and tighten the finger screw.
 6. Se to that the requirements of installation and ventilation are met.
 7. Connect the supply cord to the main power supply.
- (If you are using a $\varnothing 28$ harness, please disregard 1 and 2.)

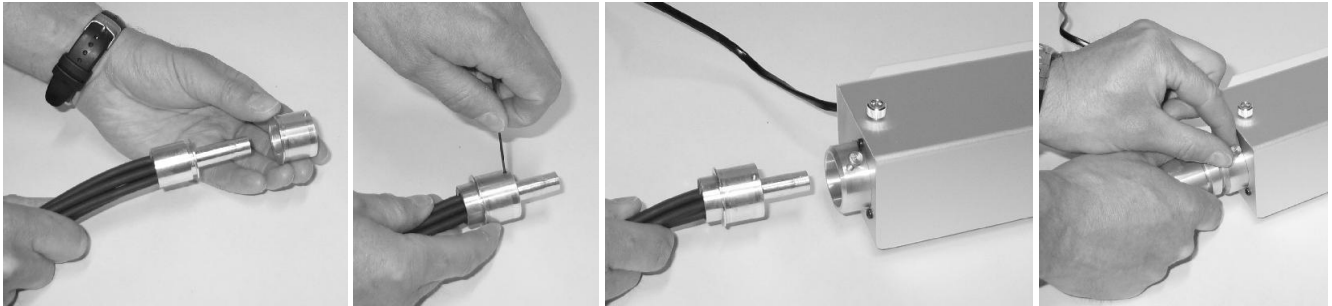

5. Fixating the light generator to the surface

1. Loosen the finger screw at the top of the light generator to open the lid.
2. Be careful not to damage the lamp. Remove it if necessary.
3. Mount the light generator with one or two screws (not included) through the holes beside the lamp.
4. Refit the lamp and close the lid again.

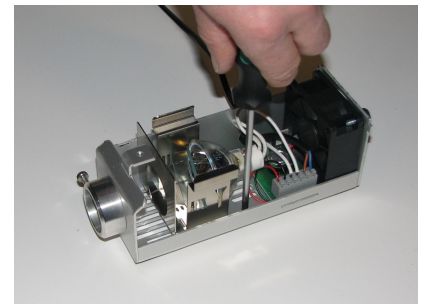
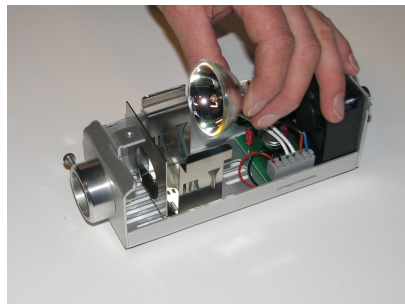
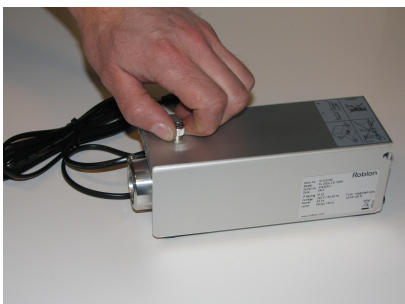

6. Mounting of optional colour filters.

(not included).

1. Loosen the finger screw and open the lid.
2. Mount the Colour filter.
3. Close the lid again and secure the finger screw.

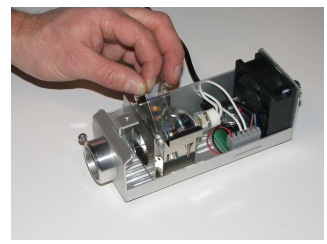
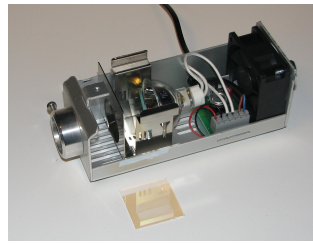
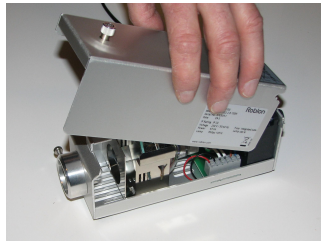
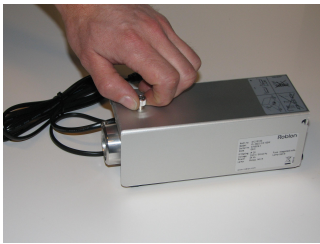

7. Trouble shooting

Symptom	Cause	Solution
No light	Is the power ON?	Turn ON the power.
	Is the power cord properly connected?	Reinsert the power cord.
	Is the light generator too hot?	Check with the installation instructions. Cool off for 10 minutes and try again.
No light, but fan is running	Is the lamp blown?	Replace lamp with new one.
Light switches ON and OFF	Is the light generator too hot while operating?	Check with installation instructions.
	Is the fan blocked?	Clear the airways.
	Is the fan broken?	Replace the fan with a new one.
The light output has diminished	Is the lamp old?	Replace the lamp with a new one.
	Are the filters dirty?	Clean the filters with a damp cloth. Finish by wiping off with a dry lint-free cloth.
	Is the fibre harness common end dirty?	Clean the harness common end with a damp cloth. Finish by wiping off with a dry lint-free cloth.

When Installing one or more light generators in a closed compartment

The light generator need to breathe to keep cool.

Ventilation holes must be made in the compartment corresponding to min. 29 cm² of air intake and min. 29 cm² of exhaust air.

When using this installation method, the air intake and exhaust of the light generator must be separated.

Use ventilation hose adapter, +78000510, for standard Ø60 mm flexible ventilation hose, to Guide the exhaust air out of the compartment.

When doing so, it is possible to install the light generator in very small compartments.

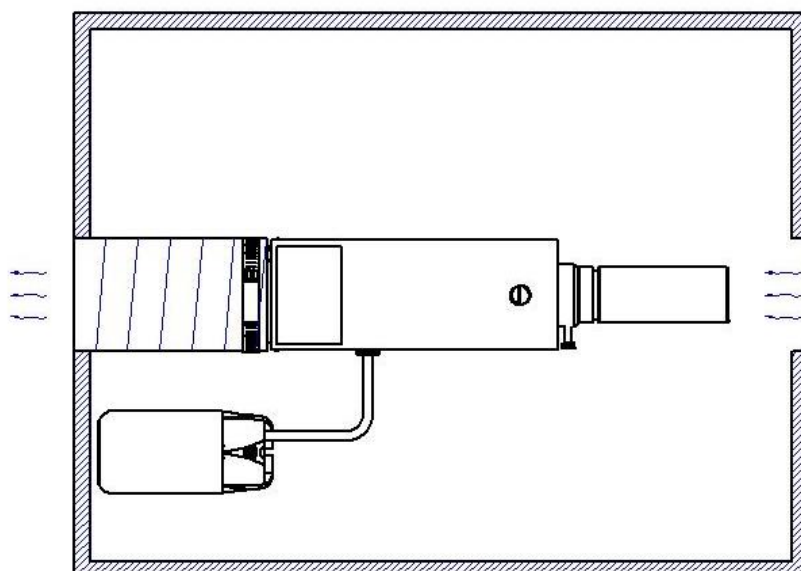



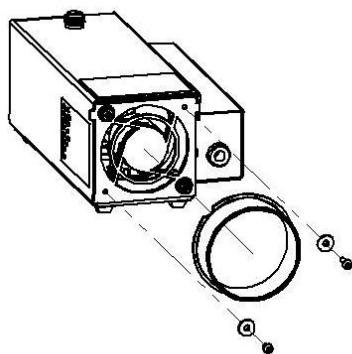

Mounting of ventilation hose adapter.



(not included)

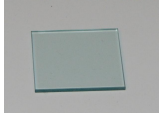

8. Spare parts

Description	Roblon item no.:	Model designation	Image
Lamp	+65127595	14515 from Philips (for 75W units)	
	+65129905	6834/25H FO from Philips (for 100W units)	
Fan	+64060122	KDE-1206PTV2 MS.A.GN from Sunon	
Heat filter	+54001000	KG-2	
Transformer	+68105020	HTM105 from Osram (for 100W European units)	
	+68105042	LET-151R from Lightech (for US units)	

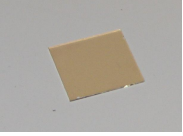
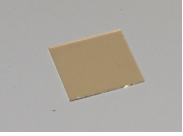
9. Accessories

Description	Roblon part no.:	Model designation	Image
Colour filter	+78000190	Colour Filter, FL 150-3/FL2002-2B, yellow	
	+78000191	Colour Filter, FL 150-3/FL2002-2B, green	
	+78000192	Colour Filter, FL 150-3/FL2002-2B, blue	
	+78000193	Colour Filter, FL 150-3/FL2002-2B, red	
CTC filter	+78000197	CTC Filter, FL 150-3/FL2002-2 B, -500K	
	+78000198	CTC Filter, FL 150-3/FL2002-2 B, -1200K	
	+78000199	CTC Filter, FL 150-3/FL2002-2 B, -900K	
Ventilation hose adapter	+78000510	For connecting light generator to Ø60 mm flexible ventilation hose.	

Roblon

Roblon Lighting Tel: +45 9620 3366
Nordhavnsvej 1 Fax: +45 9620 3396
9900 Frederikshavn info@roblon.com
Denmark

Roblon accepts no responsibility for possible errors in printed and electronic material. Roblon reserves the right to alter or discontinue products without notice.
©2012, Roblon A/S