

LMG500

Precision Power Analyzer

1 to 8 Channels • DC - 10 MHz • Accuracy 0.025 %



To develop, test and optimize
E-machines, frequency inverters, transformers,
power electronics, power supplies, lighting

- Base accuracy of power 0.025 %
0.015 % of reading + 0.01 % of range
- Bandwidth from DC and 0.05 Hz up to 10 MHz
- Absolutely gapless sampling
- All samples being processed to capture all inrush currents, signal spikes or drop-outs
- Harmonics and interharmonics of up to 50 kHz in realtime, up to 1 MHz post processed

LMG – A Synonym for Precision Power Measurement

Precision Power Meters (German: Präzisions-LeistungsmessGeräte) of the series **LMG** by **ZES ZIMMER** – **LMG95** for single phase, **LMG450** and **LMG500** for multiphase measurements – are well known world-wide and have been proved invaluable in industrial applications, R&D and education. The character string **LMG** has thus become a synonym for precise and wideband measurement of electrical power. All variables linked with electrical power like current, voltage, harmonics, flicker and energy are also precisely determined for optimizing products in efficiency, reliability, electromagnetic compatibility (EMC), and life-cycle costs.

The **LMG500** is best-in-class for measurements at:

- Devices, e.g. E-machines, frequency inverters, transformers
- Installations and parts of those

- Power grids and consumers to determine interactions
- Components, e.g. ferrite cores, semiconductors, capacitors

Another application field are CE compliance tests on devices, analyzing the feedback of harmonics and flicker (load variations) and standby power consumption.

The most important features of the **LMG500** are:

- Wide dynamic measuring range from 3V to 1000V/3200Vpeak, 20mA to 32A/120Apeak in direct measurement only by a single pair of sockets for each voltage and current input
- Modular with 1 to 8 power measuring channels
- Measuring accuracy at 45 to 65 Hz 0.015% of reading plus 0.01% of range

- 3MSample/s per channel, absolutely gapless sampling with the evaluation of all sampling values
- Capturing transients and fast signal changes by event triggering in parallel to the ongoing measurement
- Group delay between voltage and current measuring input <3 ns as standard to ascertain very precise measurements at low $\cos\phi$ and/or high frequencies
- Harmonics and interharmonics up to 50kHz internally, and up to 1MHz with an external PC
- Flicker, interactions between network and load
- Ergonomic user interface for easy, intuitive use of the power analyzer
- Real-time evaluation of the measurements in numeric tables and diagrams
- Data communication interfaces with high transfer rates (RS232, USB, IEEE488.2, Ethernet)

Easy device settings and intuitive results display



Global settings, shown here is the star-to-delta conversion

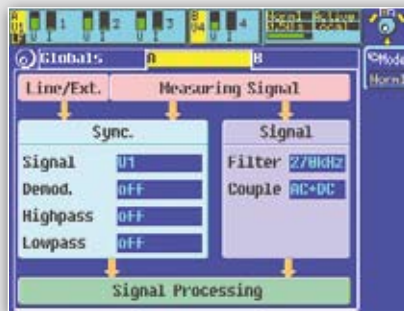

Independent setup of synchronization filter and measurement path filter

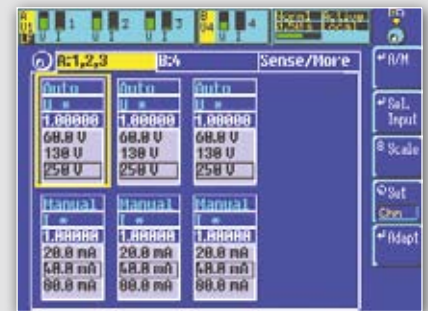

Selection of input, scaling and measurement range

Different display modes for result in numerical and graphical formats

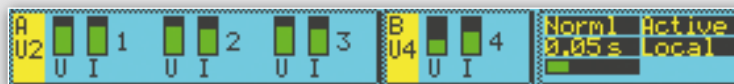

Status bar for overviewing the running measurement

- A status bar is permanently displayed in all menus
- Measurement display for one or four power channels, alternatively with six or 20 values, 40 values and more with scroll bars
- Global settings
- Two independent filter sets for the synchronization and the measurement path
- Choice of manual or automatic setting of the measurement ranges



Measurement display with six values



Measurement display with 20 values

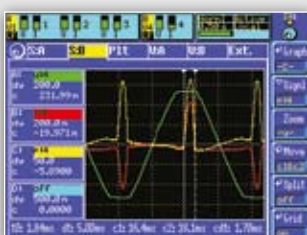

Graphical display for wave form



Line plot (trend display)



Vector diagram

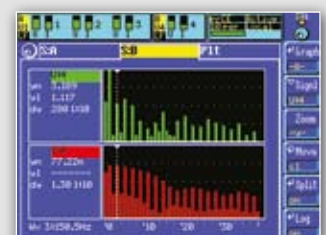

Parallel display of harmonics as bar graphs

Measuring inputs for ultimate requirements



- Current inputs I^* , wide dynamic range: 20 mA to 32 A / 120 A_{peak} by only one socket pair.
- Separated HF current inputs I_{HF}^* : 150 mA to 1.2 A / DC to 10 MHz
- No need for changing external shunts!



- Voltage inputs U^* : 3 V to 1000 V / 3200 V_{peak}
- Measuring with external sensors: Inputs I_{Sensor} and U_{Sensor} 30 mV to 4 V / DC to 10 MHz
- Auxiliary voltage ± 15 V and identification of external sensors

- Up to 8 power measuring channels with the compact 8-channel meter LMG500-8 or with two linked LMG500-4. In both cases all channels are sampled gaplessly and synchronously with 3 MSamples/s.
- All input sockets are touch-proof, and isolated against each other and against earth (max. 1000 V / CAT III).
- High bandwidth of 10 MHz, hence very short pulses are measured precisely
- Very low capacity of measurement inputs against earth <30 pF, thus no distortion of measured signals

LMG-CONTROL – the LMG in your PC

LMG-CONTROL is the complementary PC software for **ZES ZIMMER** power analyzers to configure the instrument and to display, log and analyze the measuring values.

Modifications to the setup of the **LMG** are immediately active. The multi-window implementation permits displaying the measurement in multiple ways at the same time.

Saving and loading of the instrument configuration along with the software settings in a single project file permits easy repeating of a measuring task.

On demand **LMG-CONTROL** creates a report with the configuration settings and the current measuring values. This status report is particularly useful for remote diagnosis for the user and the **ZES ZIMMER** support team.

The wave form analysis module (order-no. **LMG-Control-WA**) extends the **LMG** with valuable features like frequency analysis and harmonics of up to 1 MHz as well as the calculation of electrical values within an adjustable frame and the display of transients with a resolution down to 330 ns.



LMG500 – Versatile and Flexible for Many Applications

High base accuracy – wide dynamic range

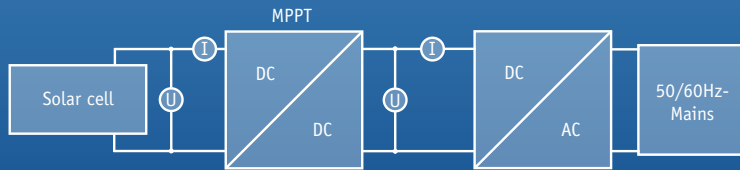

The high nominal accuracy of 0.025% allows for correct measuring of very low currents in the 32A range. This is essential in test environments which do not allow for measuring gaps which inevitably occur when changing the measuring range.

To operate a solar generator at its power generating optimum the maximum power point tracker (MPPT) varies the input resistance of the MPPT converter unit matching the inner resistance of the photovoltaic cell. The resistance is continuously changed by a small fraction optimizing the energy production under changing weather conditions. The **LMG500** tracks such changes precisely.

Solar technology

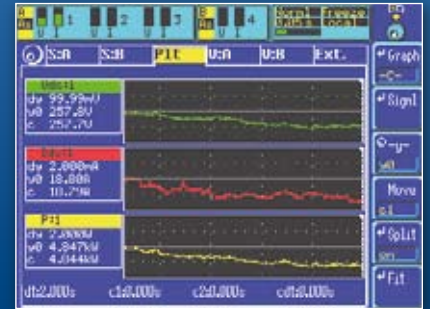

Voltage, current and effective power highly precise without range switching

High-frequency signals exactly determined

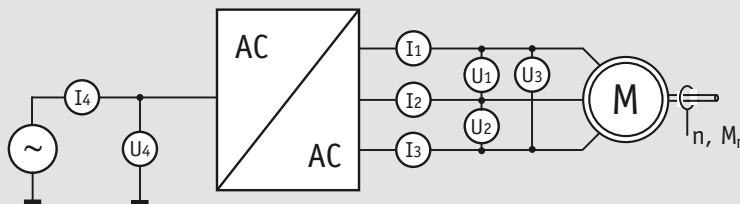

Power electronics
Inverters



Extra-high current peaks at simultaneous switching edges

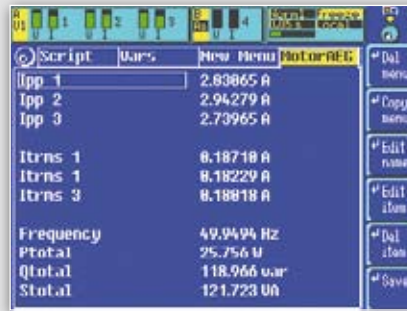

Custom display with Ipp and Itrms

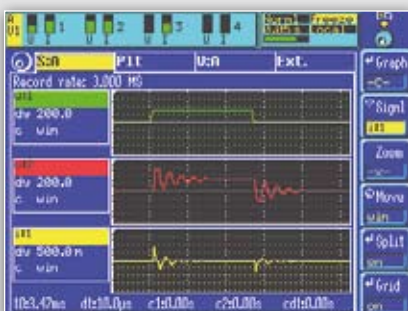

Voltage at inverter output as well as voltage and current at motor with long connection cables

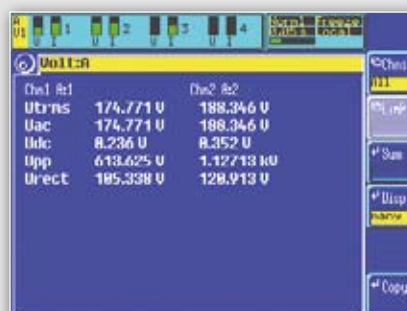

Easy to recognize: The peak value Upp doubles

Due to the high bandwidth of 10 MHz, high-frequency current peaks at the frequency inverter output can be successfully sampled. The combination of 4 measuring channels exactly determines the efficiency of an inverter. Each switching edge is the cause for a transient current peak, being conducted through the coil capacitance. The custom display shows that Ipp is a magnitude higher than Itrms.

Voltage peaks through reflection may occur on long connection cables between frequency inverter and motor. They attain up to the two-fold of the transmitted voltage pulse and put additional strain on the cable isolation.

Precise measurements at low power factors

Chokes
Transformers
Ultrasound



To increase the efficiency of contemporary PWM frequency inverters, fast switching semiconductors are used for minimizing the switching losses in the output stage. However, the extremely steep voltage edges cause capacitive currents that stress bearings and isolation of the motors – this causes unnecessary wearing and possibly an early break down.

Motor filters (e.g. du/dt-filters) attenuate the voltage edges in rise and fall, but generate power losses by the filters' transient oscillations (typ. >100kHz).

Power measurement up to 10MHz demands that current and voltage channels are designed in a way that the delay between each other is very small. With the **LMG500** this delay is less than 3 ns, or equal to an angle error <1 μrad at 50Hz. Due to this feature the **LMG500** is best suited to measure the power losses of trans-

formers, chokes, capacitors and ultrasonic generators at very low power factors. The instrument with the standard factory settings is already fully sufficient for this kind of measurements. Additional options or adjustments are not necessary. If needed, however, a calibration protocol (order no. **KR-L50-LPF**) to confirm the measurement accuracies at power factors in the range of 0.01 is available on request.

Usually current or voltage transducers are used for measuring power transformers. The phase angle error of these transducers can be compensated in the delay time menu (see p.9) improving the accuracy of the measurement.

A number of standards, like IEC 60076-1, define the calculation of the corrected power. With the build-in formula editor this is easily being performed.

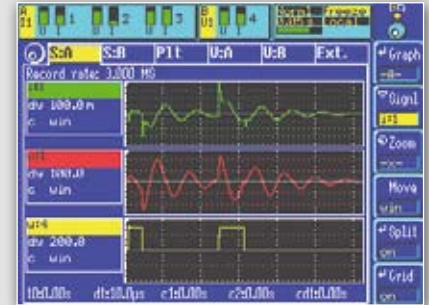

L-L voltage U4 before the filter, voltage U1 across the filter and filter input current I1

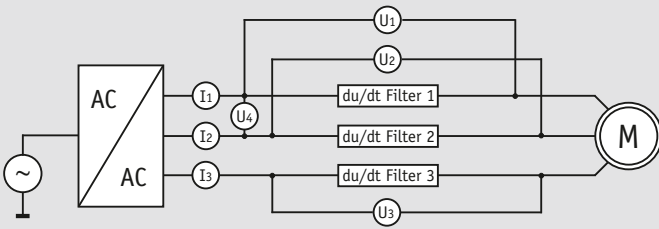

Power loss by measurement across the filter

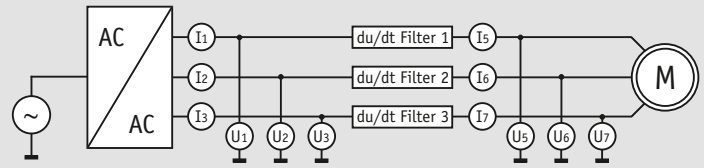

Power loss by difference measurement before and behind the filter

Ground capacitance <30pF

Lighting technology



Due to the low ground capacitance of the LMG500 measuring inputs <30pF pulsed currents and voltages can be measured directly and displayed distortion-free. The figures below show the 70 kHz pulses (U_{pp} = 2.5 kV, I_{pp} = 2.7 A) required for maintaining the plasma of the gas

discharge flat lamp (light tile). Because of the very small group delay between the voltage and current channel, the power consumption is calculated correctly despite these challenging signals.



Wave forms of current and voltage



Script	Vars	New Menu	Planon
Hfg			Planon lamp 05
U rms			0.93333 kU
U pk pos			1.99425 kU
U pk neg			-674.919 U
U pp			2.66917 kU
I rms			8.44644 A
I pk pos			1.81365 A
I pk neg			-8.89948 A
P			8.88723 kW
Q			8.88744 kvar
PF			0.99936
F			66.8865 kHz

Custom menu with numerical results

LMG500 – Compact with up to 8 Channels

For some complex measuring situations 4 power measuring channels do not suffice and therefore the LMG500 with its up to 8 channels is the superior choice. Regardless whether you use the compact 8-channel analyzer LMG500-8 or connect two LMG500-4 to collaborate like one device, all channels operate always with gapless, synchronized sampling at 3 Msamples/s for each channel. The examples below demonstrate characteristic measuring tasks which require 8 power measuring channels.

Determination of efficiency in complex systems

UPS
Wind generators

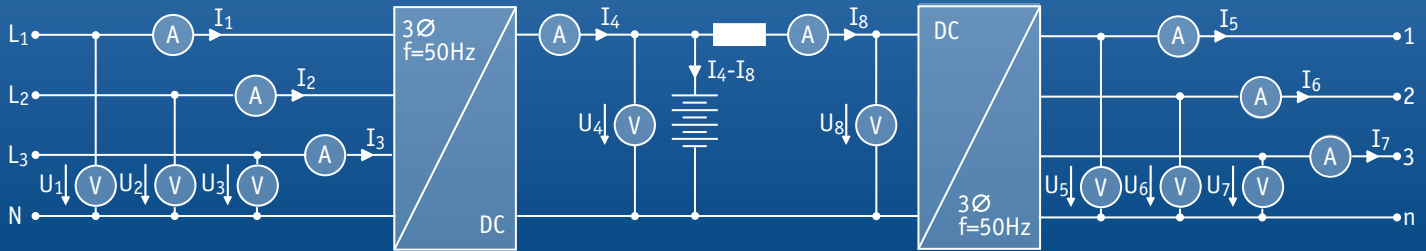

Uninterruptible power supply with intermediate DC link

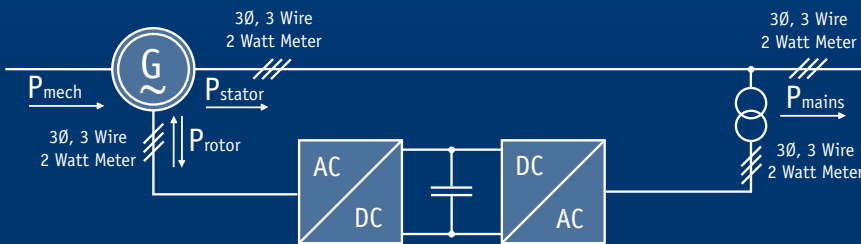

Stator power, rotor power, mains power, and mains specific inverter power each measured with the two watt meters (Aron circuit)

Wind generators without gear-box and extended range for the revolution speed: By keeping the frequency for the stator fixed and by varying the rotor frequency, the double fed asynchronous generator works with high efficiency at very different wind speeds.

Measurements with defined phase references

Three-winding
Transformers



A three-winding transformer with two output coils electrically shifted by 30° feeds two 6-pulse rectifiers. In doing so the primary winding suppresses harmonics, e. g. the 5th, 7th, 17th and 19th.

The power measurement channels are configured as two groups with channels 1 and 5 in parallel. This defines for all measurement channels the same phase reference and allows precise measurements for these kinds of special rectifier transformers with (n×30°) shifted phase angles.

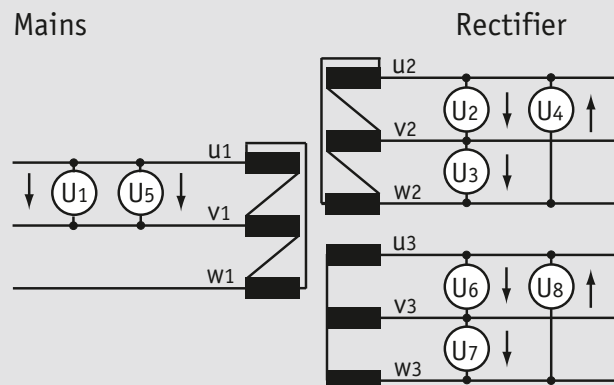

8-channel measurement at 12-pulse rectifier transformer



8 power measurement channels plus auxiliary inputs for rotation and torque

Optimization of the energy management of hybrid automotive drives by analyzing the power flow in various operation modes and conditions:

1. The car is moved by the combustion engine with or without receiving an additional boost from the inverter-fed 3-phase electrical machines M1 and M2

2. Recuperation of the braking energy back into the battery

3. Recharging of the battery by the combustion engine

An LMG500-8 with its 8 power measurement channels and the process signal interface for torque and speed captures all data synchronously to precisely determine the efficiency

of each component. Additional trigger inputs and outputs (not shown in the diagram) allow the synchronization with other instruments in large test environments.

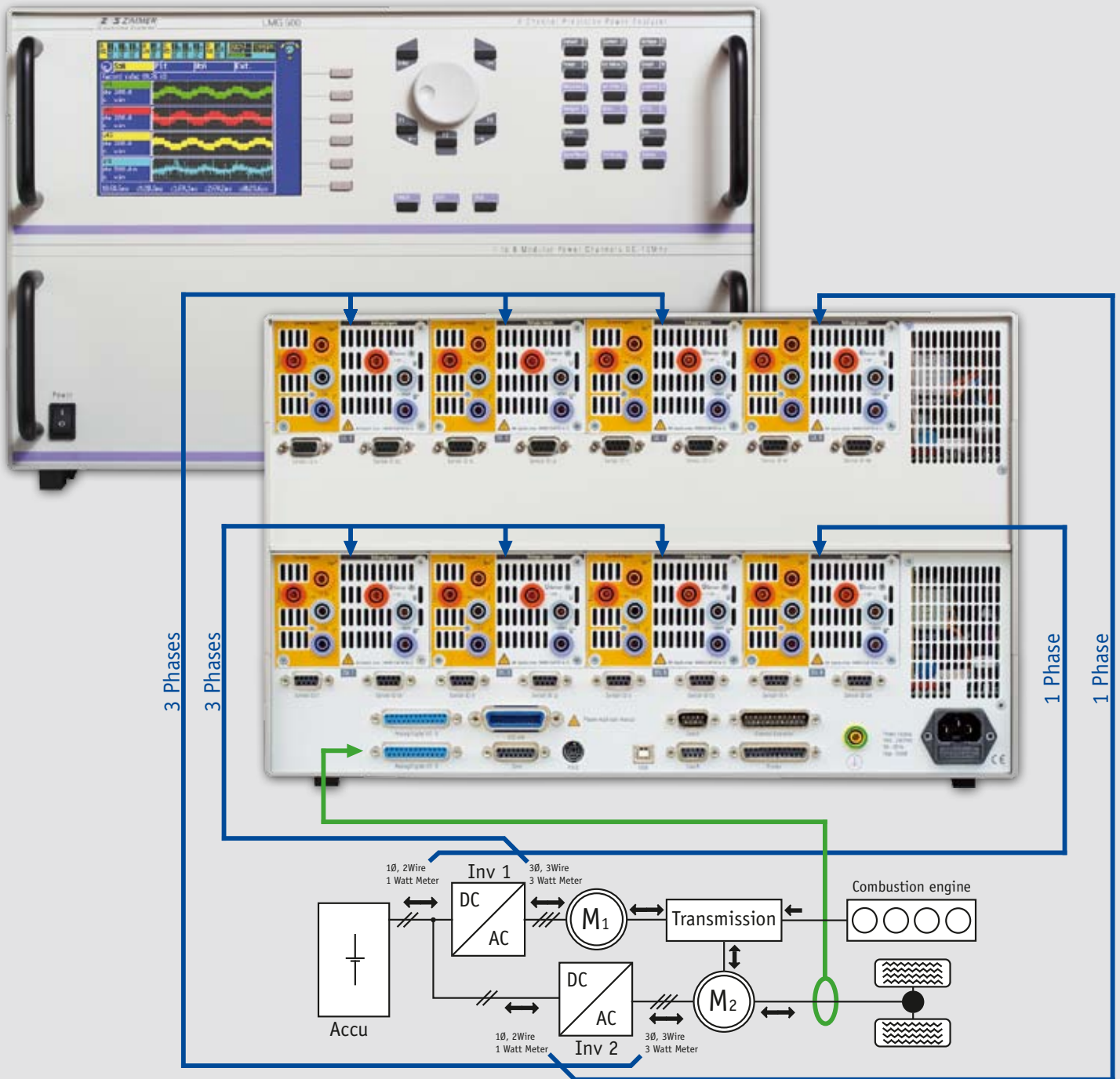

Measuring different drive modes in a hybrid car

LMG500 – Supplementary Features for Versatile Operations

Gapless data acquisition for long-term measurements

Benchmarks like SPECpower_ssj2008 and software suites as the Intel® Energy Checker have been set up to relate the power consumption of PCs and servers to their computing power. The LMG500 is one amongst only a few power meters being registered for both tests. Standby consumption of domestic appliances is covered by standards like IEC 62301. Depending on the product, parameters like efficiency, consumption and standby performance have to be measured. For example, minimum energy efficiency is set for electric motors and lamps.

For television sets and refrigerators, the maximum power input is defined depending on the size of the screen or the cooling capacity. Such tests require test times of several hours and demand absolutely gapless data acquisition. The high base accuracy allows for sufficiently precise measurements even at the low end of a measurement range, without switching to the next range (see also application note no. 102 "Measurement of standby power and energy efficiency" available for download at www.zes.com).

SPECpower
Energy label



Scripting for automated calculation

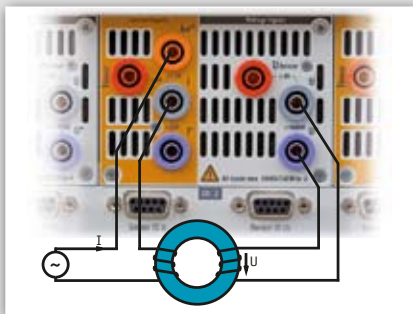

Circuitry

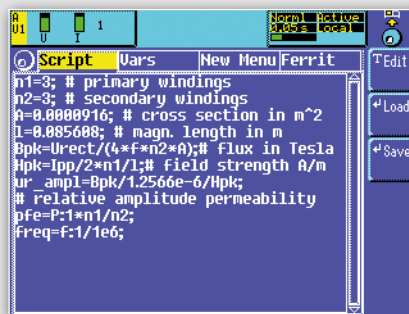

Script editor

Magnetic materials

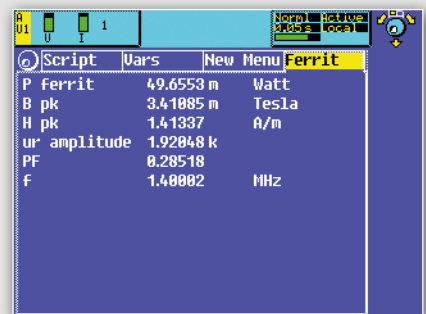

Custom menu with numerical results

Scripting gives users the opportunity to calculate within the power analyzer own additional values and shows them in a customized menu. The script can either be edited in the device, with or without an attached PS/2 keyboard, or more conveniently written on a PC and downloaded with the aid of **LMG-CONTROL**.

A good example is the measurement of the characteristics of magnetic cores. The power

measured with the exciting current I and the induced voltage U at the sensor winding (core magnetization voltage) directly yields the core losses depending on frequency of up to 10 MHz without the copper losses. With the rectified value of the sensor voltage U – a measure for the voltage-time area and therefore the induced flux – the exciting current I and the geometric core data, the characteristic curves $P(Bpk)$ and

$Bpk(Hpk)$ can be generated. With the high-performance script editor the respective curve points are calculated measuring cycle by measuring cycle.

Please refer also application note no. 108 „Programmer's Guide“ and no. 109 „Measurement of magnetic characteristics of transformer cores and coil materials“ at www.zes.com.

Monitoring Harmonics with LMG-CONTROL

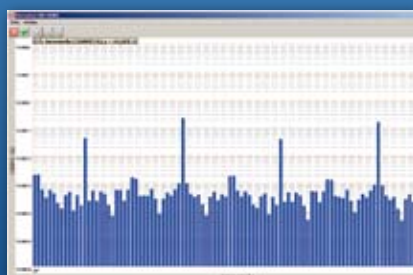

Harmonic analysis by ZES ZIMMER software LMG-CONTROL

The spectral analysis of currents and voltages from DC to 1 MHz is supported by the **ZES ZIMMER** application software **LMG-CONTROL**. The results can also be exported as tables, e. g. into MS Excel for further processing. Harmonic analysis with **LMG-CONTROL** ranges up to 1 MHz. The fundamental can be user-defined from 0.07 Hz to 1 MHz.

Avionics



The on-board power supplies of modern large scale aircraft use power distribution systems with frequencies of up to 800 Hz. Basic standards like EUROCAE ED-14D and ABD0100.1.8 have been created to define limit values. Fundamental frequencies from 360 Hz to 800 Hz must be assessed by their harmonics in ranges up to 150 kHz.

Clustered measurement channels – each with independent synchronization

Up to eight power measurement channels, each of them sampling absolutely synchronously with 3 MSamples/s, are possible with

- a coupled second device or
- the compact 8-channel meter **LMG500-8**.

The current and the voltage paths of the power measurement channels are all isolated against each other and against earth. The channels are arranged in up to 4 groups (see table): channels 1 to 4 (device 1) into groups A and B and channels 5 to 8 (device 2) into groups C and D. The synchronization source internal, external or "line" and the setup are for each group independently configurable.

Channel no.	1	2	3	4	5	6	7	8
Group formation	A		B		C		D	
Possible wiring in the groups A to D	4Ø 4Wire				4Ø 4Wire			
	4Ø 5Wire				4Ø 5Wire			
	1Ø 2L	1Ø 2L	1Ø 2L	1Ø 2L	1Ø 2L	1Ø 2L	1Ø 2L	1Ø 2L
	3Ø 3Wire			1Ø 2L	3Ø 3Wire			1Ø 2L
	3Ø 4Wire				3Ø 4Wire			
	4Ø 4Wire				4Ø 4Wire			
	3Ø 3L (Aron)/2Ø 3L		3Ø 3L (Aron)/2Ø 3L		3Ø 3L (Aron)/2Ø 3L		3Ø 3L (Aron)/2Ø 3L	
3Ø 3L (Aron)/2Ø 3L		1Ø 2L	1Ø 2L	3Ø 3L (Aron)/2Ø 3L		1Ø 2L	1Ø 2L	

The settings of groups A and B for certain wirings are independent to the settings of groups C and D. By the 4 groups 4 independent harmonic analyses can be performed.

Menu to compensate the delay time of external sensors

Currents >30A are measured with external sensors. For currents of more than 100 A, wideband (>100 kHz) current transducers, e.g. of the type **PSU**, are used. The error caused by the group delay of the current transducer can be compensated with the assistance of the delay time menu by inserting the necessary time adjustment. By doing so the precision of the power measurement can be kept on a very high level especially at low power factors.

An outstanding tool with an easy-to-use menu.

	dU/ns	dI/ns	P/W	PF
1	0	10	0.0403 kW	0.04799
2	0	3	0.0452 kW	0.05418
3	0	7	0.0379 kW	0.04831
4	0	0	0.0000 kW	0.00000
5	0	0	-----	-----
6	0	0	-----	-----
7	0	0	-----	-----
8	0	0	-----	-----

Delay time menu with compensation values for I in phase 1, 2 and 3



CE-Test61k test system in a compact 19" cabinet

CE-compliance test systems

Standby power

The **ZES ZIMMER CE-Test-Standby** test software in combination with the **LMG500** offers monitoring the power consumption in standby mode of home appliances, IT devices and similar equipment in accordance to IEC/EN 62301. The results are finally presented in a test protocol.

Testname	Status	Details
Stabilität der Leistung	Läuft	warte auf minimale Dauer (14:56:014 verbleiben)
Leistungsgrenzwert	Läuft	warte auf minimale Dauer (14:56:014 verbleiben)
• Versorgungsspannung	Fehl	
Effektivwert der Spannung	Fehl	219.98 V < 227.70 V
Spannungsfrequenz	Ok	50.00 Hz (50.00 Hz ± 1%)
minimaler Crestfaktor	Ok	1.38 > 1.34
maximaler Crestfaktor	Ok	1.38 < 1.49
Klirrfaktor (THD) der Spannung	Ok	1.88% < 2.00%
• Aussteuerung der Kanäle	Ok	
Aussteuerung des Spannungskanals	Ok	2% < 81.80% < 100%
Aussteuerung des Stromkanals	Ok	2% < 50.65% < 100%
maximale Testdauer	Ok	00:00:03.386 (max. 03:00:00.000)
überwachte Werte	Ok	

CE-Test-Standby, display of a test in progress

Harmonics and flicker

The compliance test system **CE-Test61k** allows to test product interferences towards the power distribution system caused by current harmonics and flicker in accordance with EN 61000-3-2/-12 and EN 61000-3-3/-11.

CE-Test61k

System characteristics:

- harmonics analyzer
 - according to EN 61000-4-7 up to 2 kHz
 - according to EN 61000-4-7 annex B from 2 kHz to 9 kHz
- flicker meter according to EN 61000-4-15

Valuation:

- harmonic analysis for currents up to 16 A in compliance with EN 61000-3-2
- harmonic analysis for currents from 16 A to 75 A in compliance with EN 61000-3-12
- flicker (voltage fluctuation) for currents up to 16 A in compliance with EN 61000-3-3
- flicker (voltage fluctuation) for currents up to 75 A in compliance with EN 61000-3-11

The system consists of:

- **ZES ZIMMER** power analyzer **LMG500**
- AC source, optionally the customer may use own sources
- reference impedance (for EN 61000-3-3)
- standards-compliant measuring and analysis software
- PC or notebook

Delivery turnkey in a 19" cabinet or as hardware/software package for system integration by the customer.

Please refer to the detailed product description for both products at www.zes.com.

Options and Accessories for the LMG500

IEEE488 interface (order no. L50-01): Interpretation of the complete SCPI, as well as the LMG500 specific command set. The data transfer rate is up to 1 MByte/s.

USB interfaces (order no. L50-02USB): Front side USB-A interface for the connection of a memory stick and back side USB-B interface for data transfer and remote control software.

Processing signal interface, digital and analog in- and outputs (order no. L50-03): For monitoring additional process parameters like rotation speed, torque etc. With assistance of the script

editor, variables like e.g. the efficiency can be calculated and output as control values to other devices.

Flicker meter (order no. L50-04): Compliant to EN 61000-4-15. Evaluates voltage fluctuations induced by currents of up to 16 A in compliance with EN 61000-3-3, or by currents of up to 75 A in compliance with EN 61000-3-11.

Harmonics up to 99th for U, I, P, Q und S (order no. L50-08): Current, voltage and power are analyzed up to 50 kHz with a fundamental between 0.1 Hz and 1.2 kHz. Evaluation of

interharmonics is made possible by dividing the given fundamental to a lower one using it as reference. For the harmonic analysis up to 1 MHz an external PC is required.

CE harmonics (order no. L50-09): Compliant to measurement device standard EN 61000-4-7, up to the 40th harmonic, for currents up to 16 A in compliance with EN 61000-3-2, and for currents from 16 A to 75 A in compliance with EN 61000-3-12.

DSP modules (order no. L50-010): Required for some other options.

Event triggering (order no. L50-05)

Set trigger conditions are evaluated during the normal measuring mode. When a trigger condition is met the scope display will be "frozen" (shown as "Finish" in the status bar). The normal measuring proceeds without any interruption and continues to evaluate all sample values. For the sample values u, i, p from different measuring channels, up to four trigger conditions (T1, T2, T3, T4) can be defined and

logically linked. A trigger condition can be that a value is larger or smaller than a limit, or inside/outside of a window, for an event duration of 330 ns up to 10 s. The fast sampling captures all peaks and dips. For pre- and post-event analysis up to 2 million samples around the event can be transmitted via the data interface and processed with external software.



Condition menu for event triggering

Star-to-delta conversion for 3phase-3wire systems (order no. L50-06)

In 3phase-3wire systems usually only the line-to-line voltages U_{12} , U_{23} and U_{31} and the line currents I_1 , I_2 and I_3 are available for measurement.

With the star-to-delta conversion option the line-to-line voltages can be converted to the not directly available phase voltages (line-to-neutral voltages of the star-connected load) and the related active powers can be revealed. Likewise the line currents can be converted into the „linked“ currents (line-to-line currents of a delta-connected load). From those calculated „linked“ values, other magnitudes like the harmonics are deduced.

The star-to-delta conversion works correctly even under circumstances such as unbalances of grid or load and distorted wave forms.

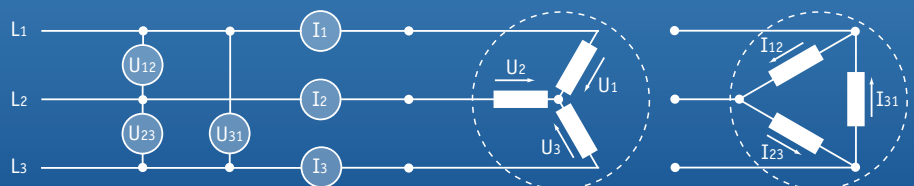

3phase-3wire system: measurement of line-to-line voltages and line currents



Calculated values (linked values) of the star-connected windings (wiring: 3+1, $U_{\Delta} I^* \rightarrow U^* I^*$)



Calculated values (linked values) of the delta-connected windings (wiring: 3+1, $U_{\Delta} I^* \rightarrow U_{\Delta} I_{\Delta}$)

Adapter for incremental rotary encoder (order no. L50-Z18)

Pulses of an incremental rotary encoder (signal u2 in cyan) are transformed into a proportional voltage with the adapter **L50-Z18** (positive/negative voltage for forwards/backwards) and are connected to the **LMG500** measuring input, here the I_{sensor} input.

In the example on the right, the status bar shows the status "Finish", signaling that the set event has triggered. Also shown are the motor voltage

(u1 - red) and the motor current (i1 - yellow). The latter rises with the electrical time constant of the rotor.

About 0.7 ms after applying current to the motor, the rotation starts and is shown by the rise of the analog, revolution-proportional adapter output signal (i2 - green). 3.5 ms after the startup of the motor current, the rotational speed of 126 U/min is already determined. It is noteworthy that the rotor has so far turned only 8°.



Rotary encoder output via adapter L50-Z18 connected to a measurement channel to record a fast motor start with high resolution

Technical Data (Summary) ‡

Voltage measuring ranges U*																
Nominal value /V	3	6	12,5	25	60	130	250	400	600	1000						
Maximum trms value /V	3,6	7,2	14,4	30	66	136	270	560	999	1001						
Maximum peak value for full scale /V	6	12	25	50	100	200	400	800	1600	3200						
Input impedance	>4,5MΩ <3pF															
Current measuring ranges I*																
Nominal value /A	20m	40m	80m	150m	300m	600m	1,2	2,5	5	10	20	32	Current measuring ranges IHF*			
Maximum trms value /A	37m	75m	150m	300m	600m	1,25	2,5	5,0	10	20	32	32	150m	300m	600m	1,2
Maximum peak value for full scale /A	56m	112m	224m	469m	938m	1,88	3,75	7,5	15	30	60	120	225m	450m	900m	1,8
Input impedance	710mΩ			84mΩ			27mΩ			8,4mΩ			100mΩ			
Sensor inputs USensor, ISensor																
Nominal value /V	30m	60m	120m	250m	500m	1	2	4								
Maximum trms value /V	37m	75m	150m	300m	600m	1,2	2,5	5								
Maximum peak value for full scale /V	62m	125m	250m	500m	1	2	4	8								
Input impedance	100kΩ 34pF															

Measuring accuracy	± (% of measuring value+ % of measuring range)									
	DC	0.05Hz...45Hz	45Hz...65Hz	65Hz...3kHz	3kHz...15kHz	15kHz...100kHz	100kHz...500kHz	500kHz...1MHz	1MHz...3MHz	3MHz...10MHz
Voltage U*	0.02+0.06	0.02+0.03	0.01+0.02	0.02+0.03	0.03+0.06	0.1+0.2	0.5+1.0	0.5+1.0	3+3	f/1MHz*1.2 + f/1MHz*1.2
USensor	0.02+0.06	0.015+0.03	0.01+0.02	0.015+0.03	0.03+0.06	0.2+0.4	0.4+0.8	0.4+0.8	f/1MHz*0.7 + f/1MHz*1.5	f/1MHz*0.7 + f/1MHz*1.5
Current I* (20mA ... 5A)	0.02+0.06	0.015+0.03	0.01+0.02	0.015+0.03	0.03+0.06	0.2+0.4	0.5+1.0	0.5+1.0	f/1MHz*1 + f/1MHz*2	-
I* (10A ... 32A)					0.1+0.2	0.3+0.6	f/100kHz*0.8 + f/100kHz*1.2	-	-	-
IHF*					0.03+0.06	0.2+0.4	0.5+1.0	0.5+1.0	f/1MHz*1 + f/1MHz*2	-
ISensor					0.03+0.06	0.2+0.4	0.4+0.8	0.4+0.8	f/1MHz*0.7 + f/1MHz*1.5	f/1MHz*0.7 + f/1MHz*1.5
Power U* / I* (20mA ... 5A)	0.032+0.06	0.028+0.03	0.015+0.01	0.028+0.03	0.048+0.06	0.24+0.3	0.8+1.0	0.8+1.0	f/1MHz*3.2 + f/1MHz*2.5	-
U* / I* (10A ... 32A)					0.104+0.13	0.32+0.4	f/100kHz*1 + f/100kHz*1.1	-	-	-
U* / IHF*					0.048+0.06	0.24+0.3	0.8+1.0	0.8+1.0	f/1MHz*3.2 + f/1MHz*2.5	-
U* / ISensor					0.048+0.06	0.24+0.3	0.72+0.9	0.72+0.9	f/1MHz*3 + f/1MHz*2.3	f/1MHz*1.5 + f/1MHz*1.4
USensor / I* (20mA ... 5A)		0.024+0.03		0.024+0.03	0.048+0.06	0.32+0.4	0.72+0.9	0.72+0.9	f/1MHz*1.4 + f/1MHz*1.8	-
USensor / I* (10A ... 32A)					0.104+0.13	0.40+0.5	f/100kHz*1 + f/100kHz*1	-	-	-
USensor / IHF*					0.048+0.06	0.32+0.4	0.72+0.9	0.72+0.9	f/1MHz*1.4 + f/1MHz*2	-
USensor / ISensor					0.048+0.06	0.32+0.4	0.64+0.8	0.64+0.8	f/1MHz*1.12 + f/1MHz*1.5	f/1MHz*1.12 + f/1MHz*1.5
Additional measurement uncertainty	in the ranges from 10A to 32A: ±(Itrms)²·30µA/A²									
Accuracies based on:	1. sinusoidal voltage and current 2. ambient temperature (23 ± 3) °C 3. warm up time 1h						4. definition of power range as the product of current and voltage range, 0 ≤ λ ≤ 1 (λ=power factor=P/S) 5. calibration interval 12 months			
Other values	All other values are derived from the current, voltage and active power values. Accuracies for derived values depend on the functional relationship (e.g. S = I * U, ΔS/S = ΔI/I + ΔU/U)									

Isolation	All current and voltage inputs isolated against each other, against remaining electronic and against earth max. 1000V/CAT III resp. 600V/CAT IV
Synchronization	The measurement is synchronized on the signal period. There is a choice to determine the period from "line", "extern", u(t), i(t) as well as their envelopes, combined with settable filters. By this very stable readings are achieved, even at signals of pulse width modulated frequency inverters and amplitude modulated electronic ballasts.
Harmonic analysis for CE compliance (option L50-09)	Measuring of current and voltage with evaluation in full compliance with EN 61000-3-2/-12, measurement according to EN 61000-4-7
Harmonic analysis up to 99th harmonic (option L50-08)	Analysis of current, voltage (incl. phase angle) and power up to 99th harmonic, in total 100 harmonics including DC component. Fundamental in the range from 0.1Hz to 1.2 kHz. Analysis up to 10kHz (50kHz without antialiasing filter). By integer divider (1...128) a new reference fundamental can be created to detect inter-harmonics. Externally on PC up to 1MHz with LMG-CONTROL software.
Flicker measuring (option L50-04)	Flicker meter according to EN 61000-4-15 with evaluation in full compliance with EN 61000-3-3/-11
Transients (option L50-05)	Detecting and recording of transients >330ns
Scope function (standard)	Graphical representation of sample values versus time
Plot function (standard)	Time (trend) diagram of max. 4 readings, minimal resolution 50ms, respectively 10ms in 50Hz-half-wave (flicker) mode
Computer interfaces	RS232 (standard) und IEEE488.2 (option L50-01), additional USB 2.0 Type B (option L50-02USB), Ethernet, RJ45 (option LMG50-02ETH). Only one interface can be used at the same time
Remote control	All functions can be remote-controlled, keyboard lock for measuring parameters
Output data	Output of all readings, data formats BIN/ASCII, SCPI command set
Transfer rate	RS232: max. 115200 Baud, IEEE488.2: max. 1MByte/s
Processing signal interface (option L50-03)	2 x 25 pin SUB-D socket with: • 8 analog inputs for process data (24Bit, ±10V) (24Bit, ±10V), 8 analog outputs (14Bit, ±10V) • 8 digital inputs, 8 digital outputs • 2 inputs for frequency (0.05Hz...6MHz) and rotation direction In- and outputs are isolated against other electronics (test voltage 500V).
Other data	
Dimensions / weight	• Bench case 1 to 4 channels W 433 mm x H 148 mm x D 506 mm / about 12 kg • Bench case 1 to 8 channels W 433 mm x H 283 mm x D 506 mm / about 23 kg • Accessories: brackets for 19" rack, 84 PU, 3 HU, D 464 mm
Protection class	EN 61010 (IEC 61010, VDE 0411), protection class I / IP20 in accordance to EN 60529
Electromagnetic compatibility	EN 61326
Operating / storage temperature	0 ... 40 °C / -20 ... 50 °C
Climatic class	Normal environment conditions according to EN 61010
Power supply	100 ... 240V, 50 ... 60Hz, max. 150W (4-channel device) respectively max. 300W (8-channel device)

‡ Please refer to the LMG500 user manual for all technical data.

Measurement Accessories and Extensions

„Plug N'Measure“ current sensors for extended current ranges up to 5000 A

For detailed specifications please refer to the „ZES Sensors and Accessories“ manual.

(1) Precision current transducer	0.02 %	DC to	1 MHz	0.8 A to 5000 A
(2) Precision AC current transformer	0.02 %	15 Hz to	5 kHz	5 A to 1500 A
(3) Clamp-on current sensor	0.15 %	2 Hz to	50 kHz	0.3 A to 3000 A
(4) Wideband current transformer	0.25 %	30 Hz to	1 MHz	10 A to 1000 A
(5) Hall effect current sensor	0.30 %	DC to	200 kHz	0.3 A to 2000 A



Example to (1):
Precision current transducers PSU700-L50 for 700 A



Example to (2):
Precision AC current transformer LMG-Z502 for 1500 A



Example to (3):
Clamp-on current sensor L45-Z06 for 40 A, 5 Hz to 20 kHz



Example to (4):
Wideband current transformer LMG-Z601 for 100 A, 30 Hz to 1 MHz



Example to (5):
Hall effect current sensors L50-Z29-Hall for 50 A to 1000 A

Precision high voltage divider

for 3/6/9/12 kV, DC to 300 kHz, base accuracy 0.05 %
Negligible phase error, therefore best suited for wideband power measuring.

- 1-channel HST for single ended voltages
- 2-channel HST for floating voltages (difference measuring)
- 3-channel HST for three phases systems (inverters)



Adapter for 3-phase measurements

Order no. LMG-MAK3

- Socket for supplying the meter LMG500/LMG450
- 4mm safety sockets as measuring access to current and voltage
- Safety acc. IEC 61010: 300V/CAT III
- CEE-Plug, 5 pins, 16 A, 2 m supply cord
- CEE-Socket, 5 pins, 16 A, for EUT



M-n motor torque software

Order no. L50-016

Torque and speed directly calculated from the current and voltage at a motor compliant to the IEC standard that is powered by a frequency inverter or directly by a 3-phase net. Accuracy better than 2% of nominal value of torque respectively rotation speed. Configurable with plugin in software LMG-CONTROL.

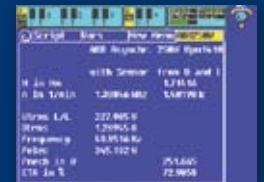

PC software

Order no. LMG-CONTROL-B

To configure power analyzers, recording and storage of samples, to visualize data as list or diagram. Status report for the system diagnostics. The basic version is free of cost.

Order no. LMG-CONTROL-WA

Additional module for LMG-CONTROL, logging and analysis of sample values of the LMG, frequency spectrum and harmonic analysis up to 1 MHz, frame analyzer, logging of transients.



Calibration

Order no. KR-L50-B, KR-L50-CHN

Calibration with certificate, traceable according to ISO9000, basis package and in addition for each power channel.

Calibration and service package for extended warranty

Order no. L50-KSP

With the purchase of the calibration and service package, the warranty can be extended every year for further 12 months. A prerequisite is the calibration traceable according to ISO9000 at first delivery of the device. Every 12 months the device has to be sent back to ZES ZIMMER for a further calibration and if necessary for adjustment. Along with the calibration the appropriate maintenance work is carried through. During the warranty period and extended warranty period all incidental repairs are free of charge. Repairs of failures by abrasion and faulty handling are excepted from the warranty.

Kalibrierschein Calibration Certificate



ZES ZIMMER Electronic Systems
Tabaksmühlenweg 30
D-61140 Oberursel, FRG
Tel. +49 (0)6171 62 57 50
Fax +49 (0)6171 520 86

Das unten angegebene Maßgerät wurde gemäß dem nachfolgenden Messprotokoll kalibriert und entspricht den Herstellerangaben. Das Kalibrierintervall beträgt 12 Monate.
ZES bestätigt, dass die verwendeten Referenzgeräte und Normale der Physikalisch-Technischen Bundesanstalt (PTB) direkt oder des Deutschen Kalibrierinstituts (DKD) nachweisbar sind. Diese Kalibrierung erfüllt die Anforderungen der ISO9000. Der Kalibrierschein erfüllt die Kriterien der EN45001.
The below instrument has been calibrated like shown in the following calibration protocol and meets the manufacturer specifications. The recalibration interval is 12 months.
ZES confirms, that the used reference devices are traceable to the national standard laboratory Physikalisch-Technische Bundesanstalt (PTB) or the german calibration service (DKD). This calibration sheet meets the requirements of ISO9000 and the EN45001.

Gegenstand/Objekt: Leistungsmessgerät II
Hersteller/Manufacturer: ZES ZIMMER Electronic Systems GmbH
Typ/Model: LMG505

© 2011 - ZES ZIMMER Electronic Systems GmbH - subject to technical changes, especially to improve the product, at any time without prior notification.

ZES ZIMMER

Germany (headquarter)

ZES ZIMMER Electronic Systems GmbH
Tabaksmühlenweg 30 • D-61140 Oberursel
sales@zes.com • +49 6171 628750
www.zes.com

United States (subsidiary)

ZES ZIMMER, Inc.
44 Grandville Ave. SW • Suite 360
Grand Rapids • MI 49503-4064
usa@zes.com • +1 760 550 9371