



★ ★ ★ ★ ★ ★ **HELLO KITTY** ★ ★ ★ ★ ★ ★

© 1976, 2012 SANRIO CO., LTD.

## 19" LCD TELEVISION



**USER MANUAL**  
**KT2219**





**⚠ CAUTION: THIS IS NOT A TOY!**

Electrically Operated Product - Please use care when plugging into AC outlet.

# SAFETY INSTRUCTIONS AND WARNINGS

TO PREVENT FIRE OR SHOCK HAZARD, DO NOT USE THIS PLUG WITH AN EXTENSION CORD, RECEPTACLE OR OTHER OUTLET UNLESS THE BLADES CAN BE FULLY INSERTED TO PREVENT BLADE EXPOSURE. TO PREVENT FIRE OR SHOCK HAZARD, DO NOT EXPOSE THIS APPLIANCE TO RAIN OR MOISTURE.

 <p>The lightning flash and arrow head within the triangle is a warning sign alerting you of "dangerous voltage" inside the product.</p>	<p><b>CAUTION</b> <b>RISK OF ELECTRIC SHOCK</b> <b>DO NOT OPEN</b></p> <p>CAUTION: TO REDUCE THE RISK OF ELECTRIC SHOCK DO NOT REMOVE COVER (ON BACK), NO USER SERVICEABLE PARTS INSIDE. REFER SERVICING TO QUALIFIED SERVICE PERSONNEL.</p>	 <p>The exclamation point within the triangle is a warning sign alerting you of important instructions accompanying the product.</p>
---	--	---

Caution Markings are located at rear enclosure of the apparatus

## IMPORTANT SAFETY INSTRUCTIONS

1. Read these instructions.
2. Keep these instructions.
3. Heed all warnings.
4. Follow all instructions.
5. Do not use this apparatus near water.
6. Cleaning - Unplug this product from the wall outlet before cleaning. Do not use liquid cleaners or aerosol cleaners. Clean only with dry cloth.
7. Do not block any ventilation openings. Install in accordance with the manufacturer's instructions.
8. Do not place this product on an unstable cart, stand, tripod, bracket, or table. The product may fall, causing serious injury to a child or adult, and serious damage to the product. Use only with a stand, or bracket, recommended by the manufacturer, or sold with the product. Any mounting of the product should follow the manufacturer's instructions, and should use a mounting accessory recommended by the manufacturer. A product and cart combination should be moved with care-quick stops, excessive force and uneven surfaces may cause the product and cart combination to overturn.
9. Do not install near any heat sources such as radiators, heat registers, stoves, or other apparatus (including amplifiers) that produce heat.
10. Do not defeat the safety purpose of the polarized or grounding-type plug. A polarized plug has two blades with one wider than the other. A grounding type plug has two blades and a third grounding prong. The wide blade or the third prong is provided for your safety. If the provided plug does not fit into your outlet, consult an electrician for replacement of the obsolete outlet.
11. Protect the power cord from being walked on or pinched particularly at plugs, convenience receptacles, and the point where they exit from the apparatus.



12. Only use attachments/accessories specified by the manufacturer.
13. Unplug this apparatus during lightning storms or when unused for a long periods of time.
14. Refer all servicing to qualified service personnel. Servicing is required when the apparatus has been damaged in any way, such as power-supply cord or plug is damaged, liquid has been spilled or objects have fallen into the apparatus, the apparatus has been exposed to rain or moisture, does not operate normally, or has been dropped.
15. This appliance shall not be exposed to dripping or splashing water and that no object filled with liquids such as vases shall be placed on the apparatus.
16. Main plug is used as disconnect device and it should remain readily operable during intended use. In order to disconnect the apparatus from the mains completely, the mains plug should be disconnected from the mains socket outlet completely.
17. Batteries of the remote shall not be exposed to excessive heat such as sunshine, fire or the like. Do not mix old and new or different types of batteries. Remove batteries when the unit is not used for long time.
18. Do not overload wall outlet. Use only power source as indicated.
19. Use replacement part as specified by the manufacturer.
20. The product may be mounted to a wall by following instructions from the manufacturer.
21. Upon completion of any service or repairs to this product, ask the service technician to perform safety checks.
22. Power Sources - This product should be operated only from the type of power source indicated on the marking label. If you are not sure of the type of power supply to your home, consult your product dealer or local power company. For products intended to operate from battery power, or other sources, refer to the operating instruction.
23. Object and Liquid Entry - Never push objects of any kind into this product through openings as they may touch dangerous voltage points or short-out parts that could result in a fire or electric shock. Never spill liquid of any kind on the product.
24. Damage Requiring Service - Unplug this product from the wall outlet and refer servicing to qualified service personnel under the following conditions:
  - a) When the power-supply cord or plug is damaged,
  - b) If liquid has been spilled, or objects have fallen into the product,
  - c) If the product has been exposed to rain or water,
  - d) If the product does not operate normally by following the operating instructions. Adjust only those controls that are covered by the operating instructions as an improper adjustment of other controls may result in damage and will often require extensive work by a qualified technician to restore the product to its normal operation.
  - e) If the product has been dropped or damaged in any way, and
  - f) When the product exhibits a distinct change in performance - this indicates a need for service.
25. Wall or Ceiling Mounting – The appliance should be mounted to a wall or ceiling only as recommended by the manufacturer.
26. Power Lines – An outdoor antenna should be located away from the power lines.
27. Outdoor Antenna Grounding – If an outside antenna is connected to the TV receiver, be sure the antenna system is grounded so as to provide some protection against voltage surges and built up static charges.

Section 810 of the National Electric Code, ANSI/NFPA No. 70-1984, provides information with respect to proper grounding of the mast and supporting structure, grounding of the lead-in wire to an antenna discharge unit, size of grounding connectors, location of antenna discharge unit, connection to grounding electrodes and requirements for the grounding electrodes. See figure below:

## EXAMPLE OF ANTENNA GROUNDING

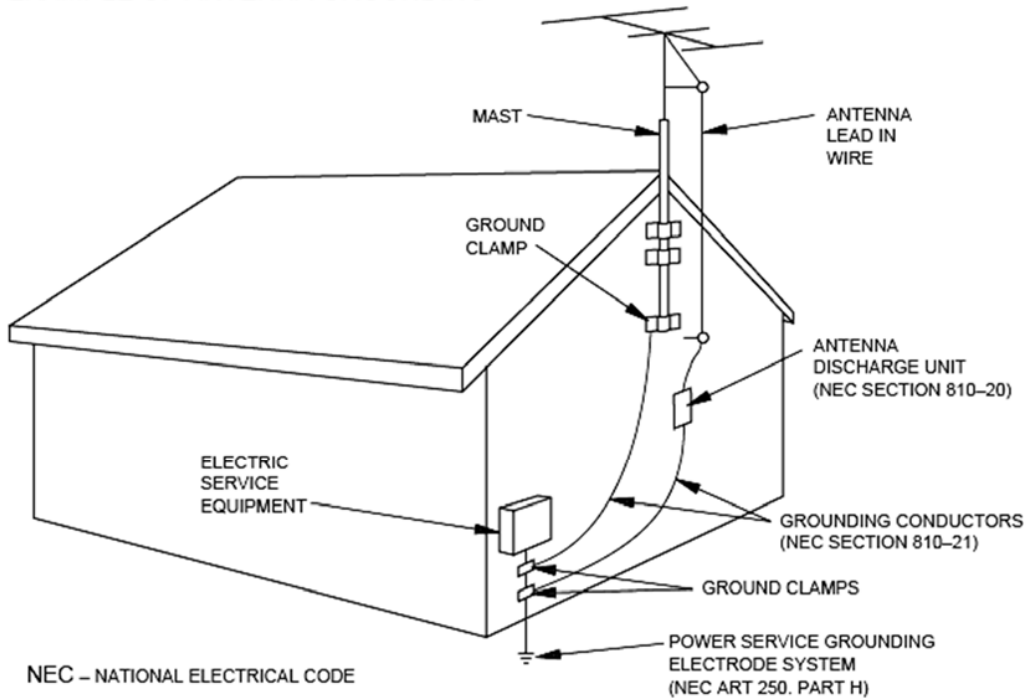

**⚠ CAUTION:**  
TO PREVENT ELECTRIC SHOCK,  
MATCH WIDE BLADE OF AC PLUG TO WIDE SLOT.  
FULLY INSERT.

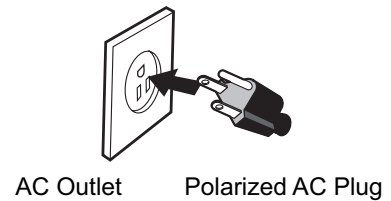

This symbol indicates that this product incorporates double insulation between hazardous mains voltage and user accessible parts.

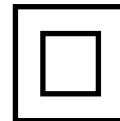

# SAVE THESE INSTRUCTIONS

## COMPLIANCE WITH FCC REGULATIONS

### FCC Declaration of Conformity

Trade Name: Hello Kitty  
Responsible Party: Spectra Merchandising International, Inc  
4230 North Normandy Avenue  
Chicago IL 60634, USA  
Hotline: 1-800-777-5331



Declaration of Conformity for Products Marked with FCC Logo, United States Only

This device complies with Part 15 of the FCC Rules. Operation is subject to the following two conditions:

- (1) This device may not cause harmful interference, and
- (2) This device must accept any interference received, including interference that may cause undesired operation.

This equipment has been tested and found to comply with the limits for a Class B digital device, pursuant to Part 15 of the FCC Rules. These limits are designed to provide reasonable protection against harmful interference in a residential installation. This equipment generates, uses and can radiate radio frequency energy and, if not installed and used in accordance with the instructions, may cause harmful interference to radio communications. However, there is no guarantee that interference will not occur in a particular installation. If this equipment does cause harmful interference to radio or television reception, which can be determined by turning the equipment off and on, the user is encouraged to try to correct the interference by one or more of the following measures:

- Reorient or relocate the receiving antenna
- Increase the separation between the equipment and receiver.
- Connect the equipment into an outlet on a circuit different from that to which the receiver is connected.
- Consult the dealer or an experienced radio technician for help.

#### **WARNING:**

Changes or modifications to this unit not expressly approved by the party responsible for compliance could void the user's authority to operate the equipment.

#### Cables -

Connections to this device must be made with shielded cables with metallic RFI/EMI connector hoods to maintain compliance with FCC Rules and Regulations.

#### Canadian notice -

This Class B digital apparatus meets all requirements of the Canadian Interference-Causing Equipment Regulations.

#### Avis Canadien -

Cet appareil numérique de la classe B respecte toutes les exigences du Règlement sur le matériel brouilleur du Canada.

## PROTECT YOUR FURNITURE!!

This system is equipped with non-skid rubber 'feet' to prevent the product from moving when you operate the controls. These 'feet' are made from non-migrating rubber material specially formulated to avoid leaving any marks or stains on your furniture. However certain types of oil based furniture polishes, wood preservatives, or cleaning sprays may cause the rubber 'feet' to soften, and leave marks or a rubber residue on the furniture.

To prevent any damage to your furniture we strongly recommend that you purchase small self-adhesive felt pads, available at hardware stores and home improvement centers everywhere, and apply these pads to the bottom of the rubber 'feet' before you place the product on fine wooden furniture.

## WELCOME TO THE WORLD OF HELLO KITTY

We have taken great care to make sure that your Digital Television was in perfect working order when it left our factory. It has been designed to give you many years of enjoyment and trouble free operation. Read this manual before operating this unit to become familiar with its features and obtain the performance that will bring you continued enjoyment for many years.

### Customer's Record:

The serial number of this product is found on its bottom. You should note the serial number of this unit in the space provided as a permanent record of your purchase to aid in identification in the event of theft or loss.

**Model Number:** KT2219

Serial Number: \_\_\_\_\_

Selecting fine audio equipment such as the item you've just purchased is only the start of your musical enjoyment. Now it's time to consider how you can maximize the fun and excitement your equipment offers. This manufacturer, the Consumer Electronics Association (CEA) and the American Speech-Language-Hearing Association (ASHA) want you to get the most out of your equipment by playing it at a safe level – a level that lets the sound come through clearly without annoying blaring or distortion and, most importantly, without damaging your sensitive hearing.

Sound can be deceiving. Over time, your hearing "comfort level" adapts to higher volumes of sound, so what sounds "normal" can actually be loud and harmful to your hearing. Guard against this by setting your equipment at a safe level BEFORE your hearing adapts.

### TO ESTABLISH A SAFE LEVEL:

- Set your volume control to the lowest level where you can hear the music comfortably and clearly. Once the volume is set, leave it there. Prolonged exposure to anything over 85 decibels can cause gradual hearing loss.
- See if your music player has a volume limiter that allows you to set a safe listening level by establishing a maximum volume level on your player. This is a great solution for parents to ensure their children listen at a safe level.
- Limit listening time to give your hearing "quiet breaks."



### BE SURE TO OBSERVE THE FOLLOWING GUIDELINES WHEN WEARING YOUR HEADPHONES OR EARBUDS:

- Do not turn up the volume so high that you can't hear sounds around you.
- Do not use headphones or earbuds while operating a motorized vehicle; it may create a traffic hazard and is illegal in many areas.

# CONTENTS

<b>SAFETY INSTRUCTIONS AND WARNINGS</b>	<b>1</b>
<b>COMPLIANCE WITH FCC REGULATIONS</b>	<b>4</b>
<b>PROTECT YOUR FURNITURE</b>	<b>5</b>
<b>WELCOME TO THE WORLD OF HELLO KITTY</b>	<b>5</b>
<b>CONTENTS OF YOUR BOX</b>	<b>7</b>
<b>SPECIAL NOTES</b>	<b>7</b>
<b>PREPARATIONS</b>	<b>8</b>
<b>CONTROL FUNCTIONS AND TERMINALS</b>	<b>9</b>
<b>GETTING STARTED</b>	<b>12</b>
USING THE REMOTE CONTROL	12
CONNECTING THE TV TO AC POWER	13
ANTENNA CONNECTION	13
CONNECTING TO A DEVICE USING THE COMPOSITE VIDEO AND STEREO AUDIO INPUT TERMINALS	14
CONNECTING TO A DEVICE USING THE COMPONENT VIDEO AND STEREO AUDIO INPUT TERMINALS	15
CONNECTING TO A DEVICE USING THE HDMI INPUT TERMINAL	16
CONNECTING TO A PC USING THE PC VIDEO (VGA) AND PC AUDIO INPUT TERMINALS	16
CONNECTION TO A HOME THEATER AUDIO SYSTEM	17
PUTTING THE UNIT ON A PROPER SURFACE	18
TURNING THE TV ON FOR THE FIRST TIME	18
SOURCE SELECT	18
CHANNEL MENU	19
PICTURE MENU	20
SOUND MENU	21
TIME MENU	22
SETUP MENU	23
LOCK MENU	24
<b>MEDIA</b>	<b>25</b>
<b>DISPLAY MODES</b>	<b>26</b>
DIGITAL VIDEO FORMATS	26
PC VIDEO FORMATS	26
<b>CLEANING</b>	<b>27</b>
<b>TROUBLESHOOTING</b>	<b>27</b>
<b>SPECIFICATIONS</b>	<b>28</b>
<b>V-CHIP TV RATING EXPLANATIONS</b>	<b>29</b>
<b>MPAA US MOVIE RATING EXPLANATIONS</b>	<b>30</b>
<b>GLOSSARY</b>	<b>31</b>
<b>WARRANTY INFORMATION</b>	<b>33</b>

## CONTENTS OF YOUR BOX

19" LCD TV	x 1 set
TV Stand	x 1 set
Remote Control	x 1 set
AAA Batteries	x 2 pcs
Mounting Screws of the TV Stand	x 4 pcs
Screwdriver	x 1 pc
Instruction Manual	x 1 set

## SPECIAL NOTES

### CARE AND MAINTENANCE

Do not use in hot and cold rooms and/or locations.

- When the unit is used in rooms and/or locations with low temperature, the picture may leave trails or appear slightly delayed. This is not a malfunction, and the unit will recover when the temperature returns to normal.
- Do not leave the unit in a hot or cold location. Also, do not leave the unit in a location exposed to direct sunlight or near a heater, as this may cause the cabinet to deform and the TV to malfunction.
- Recommended storage temperature range : 32°F to 122°F.
- Recommended working temperature range : 41°F to 104°F

### PANEL PROTECTION

The LCD display panel used in this TV is made of glass.

Therefore, it can break when the product is harshly dropped or impacted upon by other hard objects. Be careful not to be injured by broken glass pieces in case the display panel breaks.

### ABOUT AFTER-IMAGE

The extended use of fixed image program material can cause a permanent after-image on the screen.

This background image is viewable on normal programs in the form of a stationary fixed image. This type of irreversible screen deterioration can be limited by observing the following steps:

- Reduce the brightness/contrast setting to a minimum viewing level.
- Do not display fixed images for extended periods of time.
- Turn the power off when not in actual use.

### IMPORTANT INFORMATION REGARDING DISPLAY OF VIDEO GAMES, COMPUTERS, CAPTIONS OR OTHER FIXED IMAGES.

- Do not allow a still picture to be displayed for an extended period, as this can cause a permanent after-image to remain on the screen.  
Examples of still pictures include station logos, video games, computer images, text and images displayed in 4:3 mode.
- The permanent after-image on the screen resulting from abovementioned fixed images is not an operating defect and as such is not covered by the warranty.
- This TV is not designed to display fixed images for extended periods of time. Do not let images display in 4:3 mode for extended periods of time.

### PIXEL DEFECT

The LCD display panel is a high tech part capable of reproducing high definition images. In rare cases, a few non-active pixels may appear on the screen as a fixed point of blue, green or red. Please note that this does not affect the performance of your product.



## PREPARATIONS

### ATTACHING THE BASE STAND

#### TO ATTACH THE STAND:

- Place the TV set on a stable flat surface covered with a soft mat.
- Insert and tighten the 4 screws (included) with the screwdriver (included) as shown in the circled area to fix the BASE STAND securely.

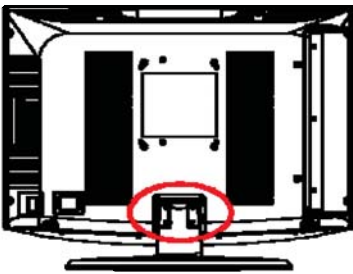

#### TO REMOVE THE BASE STAND:

(If you want to repack the TV unit for transit, storage or change to wall mounting)

- Place the TV set on a stable flat surface covered with a soft mat.
- Remove the 4 screws affixed to the neck of the BASE STAND to separate the STAND from the TV body.

### WALL MOUNTING

This unit is VESA-compliant, and is designed to be wall-mounted with a VESA-compliant (100mm x 100mm or 4-15/16" X 4-15/16") mounting kit designed for flat-panel TVs (not included). Mount the TV unit according to the instructions included in the mounting kit.

Length of wall mounting screws affixing the TV set should not exceed 8 mm (0.3").

#### NOTE

Remove the base stand before mounting the unit on the wall

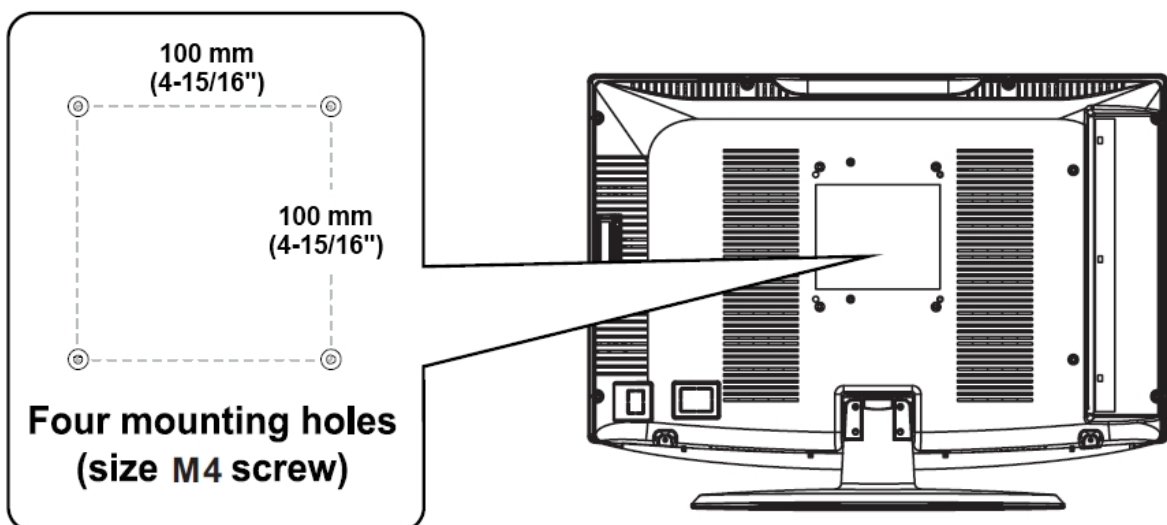

## CONTROL FUNCTIONS AND TERMINALS

### TV UNIT

#### FRONT PANEL CONTROL

STANDBY SOURCE MENU CH- CH+ VOL- VOL+



NO.	CONTROL BUTTON	FUNCTION DESCRIPTION
1	STANDBY	Press this button to turn the unit ON from STANDBY mode. Press it again to turn the set back to STANDBY.
2	SOURCE	To access the INPUT SOURCE menu.
3	MENU	Press this button to access the main menu page.
4	CH+/-	Press these two buttons to directly change the TV channel. In menu operations, these buttons serve as up/down buttons.
5	VOL+/-	Press the VOL+ or VOL - button to directly increase or decrease the sound volume level. In menu operations, these buttons serve as right/left buttons.

**NOTE:**

Functions of CH+/-, VOL+/-, MENU, SOURCE and STANDBY are also provided on the remote control. This user manual provides a description of remote control operating functions.

## SIDE PANEL CONNECTORS



NO.	NAME OF INPUT/OUTPUT	TYPE OF CONNECTOR	FUNCTION DESCRIPTION
1	DIGITAL AUDIO OUT (COAXIAL)	RCA jack	Connect to the coaxial digital audio input of an external AV amplifier with Dolby Digital (AC3) decoding capacity. Color code: orange
2	HEADPHONE	3.5mm stereo jack	Connect to a pair of stereo headphones with a 3.5mm stereo plug for private listening.
3	ANTENNA/CABLE	75-ohm F connector	Connect to a 75-ohm coaxial cable to receive signal from an outdoor antenna, cable or cable box.
4	AUDIO INPUT FOR COMPONENT & COMPOSITE VIDEO	RCA jacks x 2	Audio input: Connect to the Video Audio output jack of DVD. Color codes: white for LEFT and red for RIGHT
5	VIDEO INPUT (COMPOSITE)	RCA	Connect to a device with the composite video output jack, such as a DVD or VCR. Color code: yellow
6	COMPONENT VIDEO	RCA jacks x 3	Connect to a device with the <b>Y Pb Pr</b> output jack, such as a DVD or VCR. Color codes: green for <b>Y</b> , blue for <b>Pb</b> & red for <b>Pr</b> .
7	PC AUDIO INPUT	3.5mm stereo jack	Connect to the audio output from a PC or a DVI video device.
8	PC VIDEO INPUT (VGA)	D-sub (15-pin)	Connect to the VGA output from a PC or notebook using a VGA cable. Be sure to connect your audio cable as well if you want to hear sound from the VGA source.
9	HDMI INPUT	HDMI female connector	Connect to a device that uses HDMI cable, such as Blu-ray, HD cable / satellite box or videocam. This connection port receives pure digital audio and high definition video signals through one single cable. This port also can accept a HDCP video device for video.
10	USB PORT	Type –A USB connector	Connect to a USB flash drive for playing music and viewing picture files up to 4GB. Only FAT16 or FAT32 formatted flash drives are supported.

## REMOTE CONTROL

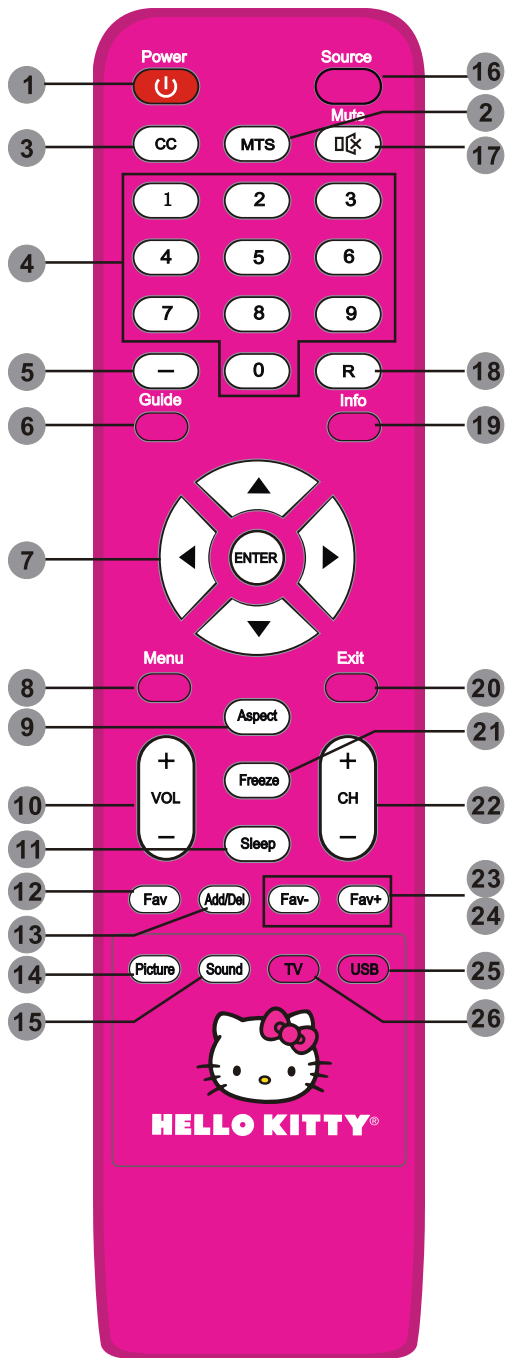

No.	FUNCTION	DESCRIPTION
1	POWER	Turn the TV on or off.
2	MTS	Select stereo/mono or second audio programming.
3	CC	Cycle between different closed captioning modes.
4	NUMBERS	Press 0-9 to select a TV channel directly when you are watching TV. The channel will change after 2 seconds.
5	-	Insert the dash for selecting digital channels directly.
6	GUIDE	Open the current digital channel information guide (antenna only).
7	THUMBSTICK	(▲/▼/◀/▶/ENTER): Allows you to navigate the on-screen menus and system settings to your preference.
8	MENU	Bring up the main TV menu on the screen.
9	ASPECT	Select different viewing modes of the TV and external video inputs.
10	VOL +/-	Press the VOL buttons to increase or decrease the sound level.
11	SLEEP	Select amount of time to let your TV turn off automatically.
12	FAVORITE (FAV)	Show your list of favorite channels.
13	ADD/DEL	Press to add/delete your favorite programs.
14	PICTURE	Select various preset picture settings.
15	SOUND	Select various preset sound settings.
16	SOURCE	Press this button to cycle through the INPUT sources.
17	MUTE	Turn the sound off from the TV. To unmute either press VOL(+) or press the MUTE button again.
18	RETURN (R)	Return to the previous channel.
19	INFO	Show the display information.
20	EXIT	Exit the main TV menu on the screen.
21	FREEZE	Freeze the TV picture.
22	CH +/-	Press the CH buttons to go through the channel list.
23	FAV-	Press this button to change to the previous favorite channel.
24	FAV+	Press this button to change to the next favorite channel.
25	USB	Launch the USB reader function for pictures and music.
26	TV	Select the source: TV.

## GETTING STARTED

### USING THE REMOTE CONTROL

#### TO INSTALL BATTERIES

1. Open the battery door.
2. Insert 2 "AAA" batteries.

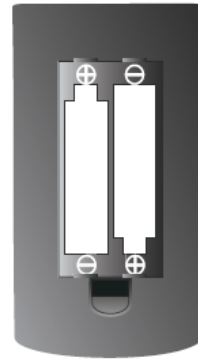

#### BATTERY REPLACEMENT

When the batteries become weak, the operating distance of the remote control is greatly reduced and you will need to replace the batteries.

#### BATTERY CARE

- Be sure that the batteries are installed correctly. Wrong polarity may damage the unit.
- (a) Do not mix old and new batteries.
- (b) Do not mix alkaline, standard (carbon-zinc) or rechargeable (nickel-cadmium) batteries.
- If the unit is not to be used for an extended period of time, remove the batteries. Old or leaking batteries can cause damage to the unit and may void the warranty.
- Never attempt to recharge "Non-rechargeable" batteries.
- Do not dispose of batteries in fire, batteries may explode or leak.
- Batteries should be changed by adults.

Use the remote control by pointing it towards the remote sensor window of the set. Objects between the remote control and sensor window may prevent proper operation.

#### CARE OF REMOTE CONTROL

- Do not expose the remote control to shock. In addition, do not expose the remote control to liquids, and do not place in an area with high humidity.
- Do not place the remote control under direct sunlight. The heat may cause deformation of the unit.
- The remote control may not work properly if the remote sensor window of the main unit is under direct sunlight or strong lighting. In such a case, change the angle of the lighting or the TV set, or operate the remote control closer to the remote sensor window.



## CONNECTING THE TV TO AC POWER

Insert the AC POWER PLUG fully into a household 120V~ 60Hz AC socket outlet. If the power plug is loosened, it could generate electric sparks and cause a fire.

### ⚠ WARNINGS

- Ensure that the AC POWER PLUG is easily accessible.
- Ensure the earth pin on the AC POWER PLUG is securely connected to prevent electric shock.
- Do not touch the AC POWER PLUG with a wet hand to prevent an electric shock.
- Do not change the power cord other than that provided with this TV to prevent fire or electric shock.
- Do not damage the power cord. A damaged cord may cause fire or electric shock.
- Do not move the TV with the cord plugged in the power outlet.
- Do not place a heavy object on the cord or place the cord near a high temperature object.
- Do not twist the cord, bend it excessively or stretch it.
- Do not pull on the cord. Grip the AC POWER PLUG body when disconnecting the power cord.
- Do not use a damaged power plug or AC power outlet.

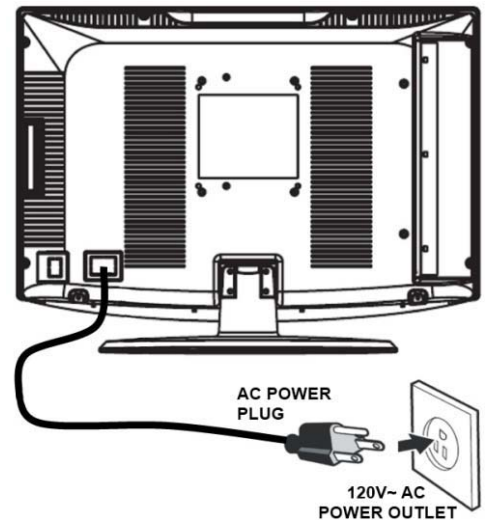

## ANTENNA CONNECTION

INSTALL the unit in a room where direct light will not fall upon the screen. Total darkness or a reflection on the picture screen may cause eyestrain. Soft and indirect lighting is recommended for comfortable viewing.

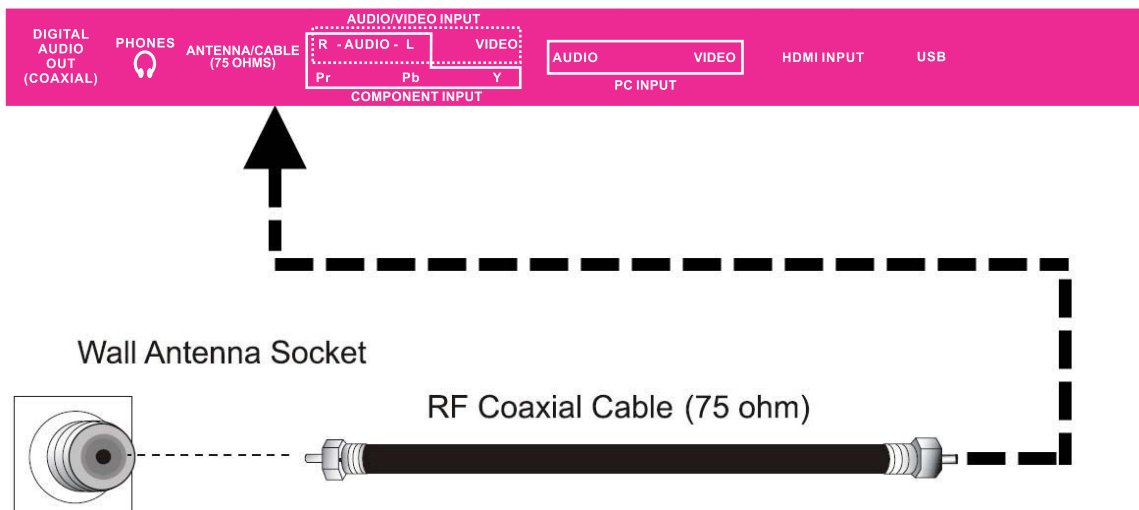

Optimum reception of color requires a good signal and will generally mean that an outdoor antenna must be used. The exact type and position of the antenna will depend upon your particular area.

### NOTE:

- It is recommended that the 75-ohm coaxial cable be used to eliminate interference and noise which may occur due to radio wave conditions.
- The antenna cable should not be bundled with the power cord and the like.
- If the antenna is not installed properly, contact your dealer for assistance.

## CONNECTING TO A DEVICE USING THE COMPOSITE VIDEO AND STEREO AUDIO INPUT TERMINALS

How to connect:

Connect the AUDIO (L/R) and VIDEO jacks on the TV to the corresponding color-coded output jacks on the device, such as a VCR, using a good quality Audio/Video cable (not included) as shown below :

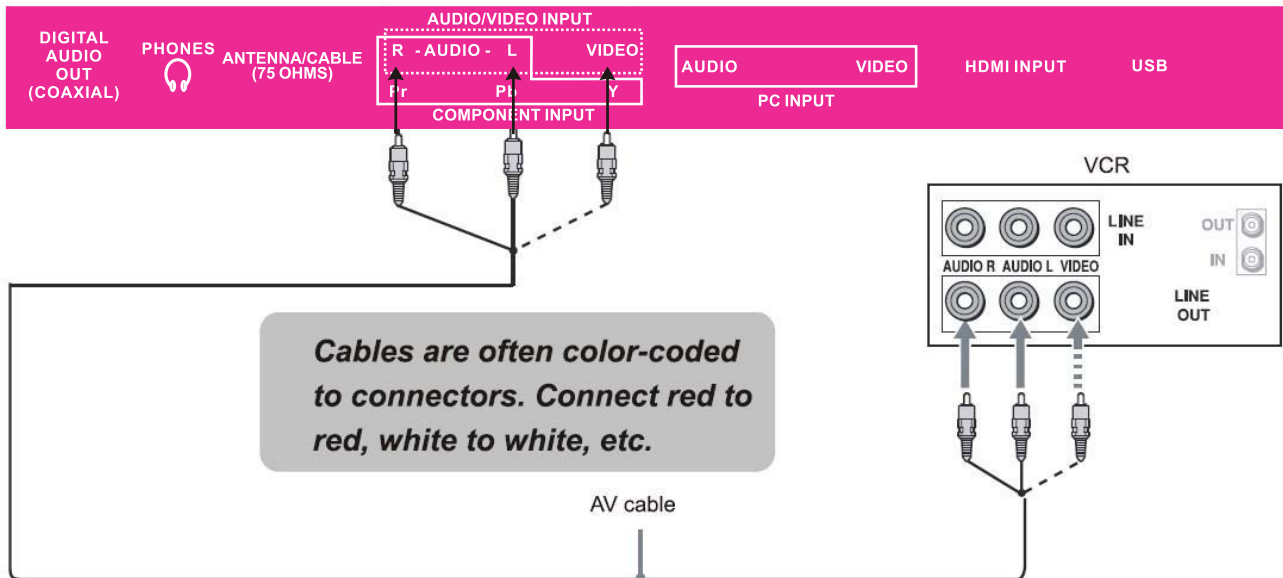

To play the VCR:

1. Turn on your TV, then press SOURCE button. The INPUT SOURCE menu opens.
2. Press ▲ or ▼ to select AV, then press ENTER to confirm.
3. Turn on your VCR , insert a videotape and press the Play button.

## CONNECTING TO A DEVICE USING THE COMPONENT VIDEO AND STEREO AUDIO INPUT TERMINALS

How to connect:

1. Connect the Y, Pb, Pr input jacks on the TV to the corresponding color coded output jacks on the device, such as a DVD player, using a good quality Component Video cable (not included) as shown below.
2. Connect the AUDIO (L/R) input jacks on the TV to the corresponding color coded output jacks on the device using a good quality Audio cable (not included).

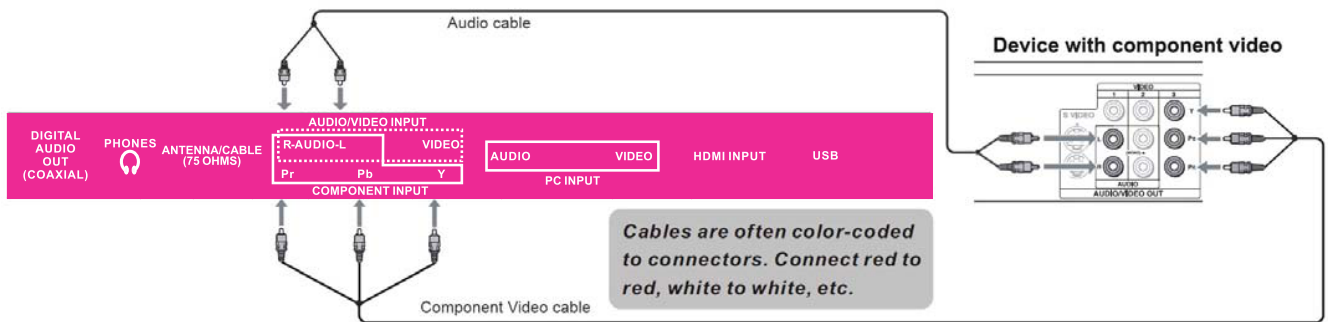

To play component video from a DVD player:

1. Turn on your TV, then press SOURCE button. The INPUT SOURCE menu opens.
2. Press ▲ or ▼ to select Component, then press ENTER to confirm.
3. Turn on your DVD player and set it to the correct video output mode. See the device's user guide for more information.



## CONNECTING TO A DEVICE USING THE HDMI INPUT TERMINAL

How to connect:

Connect the HDMI connector on the TV to the HDMI connector on the device, such as a Blu-ray disc player, using a good quality HDMI cable (not included) as shown below :

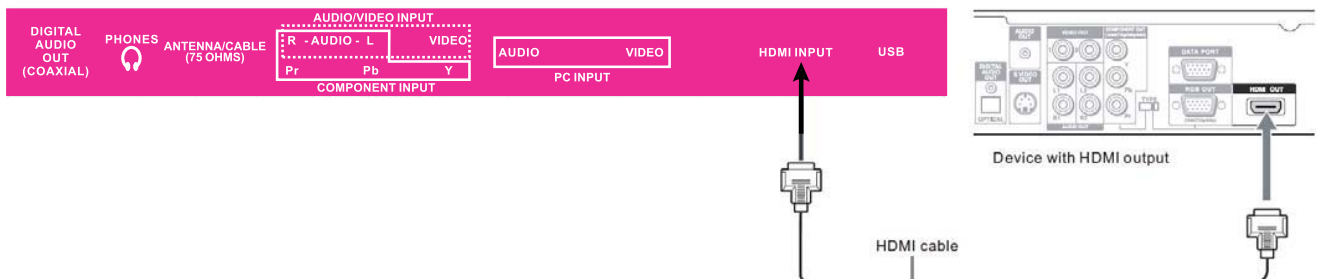

To play a Bu-ray disc player:

1. Turn on your TV, then press SOURCE button. The INPUT SOURCE menu opens.
2. Press ▲ or ▼ to select HDMI, then press ENTER to confirm.
3. Turn on your Blu-ray disc player and set it to the correct video output mode. See the device's user guide for more information.

### NOTE:

If the external device has DVI output only, use a DVI to HDMI adapter cable (not included) to connect to the HDMI terminal. Connect the audio cable to the PC AUDIO INPUT jack on the TV.

## CONNECTING TO A PC USING THE PC VIDEO (VGA) AND PC AUDIO INPUT TERMINALS

How to connect:

1. Connect the PC VIDEO (VGA) connector on the TV to the corresponding VGA connector on the PC using a good quality VGA cable (not included) as shown below.
2. Connect the PC AUDIO input jack on the TV to the corresponding output jack on the PC using a good quality Audio cable with 3.5mm stereo plugs (not included).

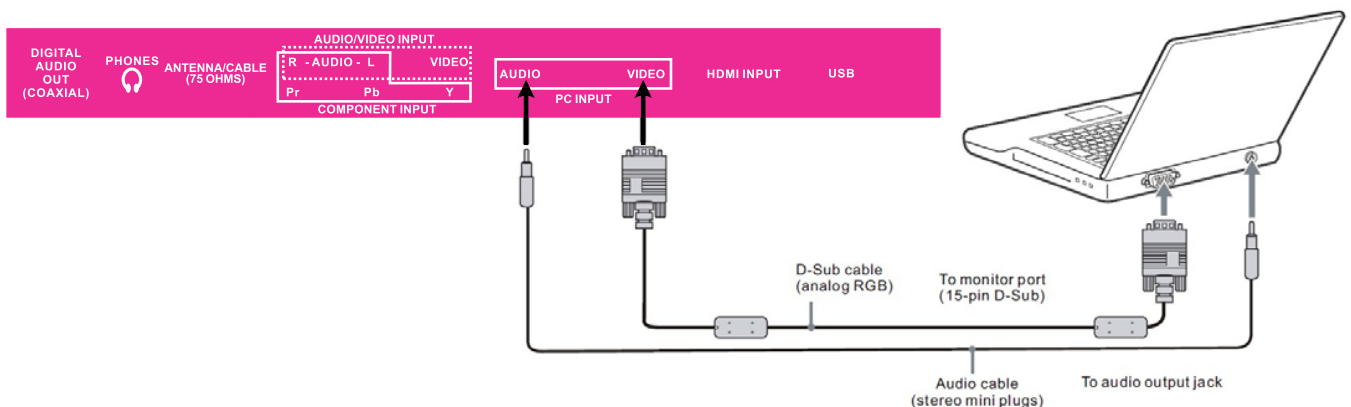

To play video from a PC:

1. Turn on your TV, then press SOURCE button. The INPUT SOURCE menu opens.
2. Press ▲ or ▼ to select VGA, then press ENTER to confirm.
3. Turn on your PC and adjust the display properties as required. Please also see the PC Video Format Table under the DISPLAY MODES section for more information.

## CONNECTION TO A HOME THEATER AUDIO SYSTEM

### For BEST Audio Performance

Connecting to a Home Theater System:

Dolby Digital can deliver optimal 2 channel stereo or surround sound with five discrete full range channels plus a sixth channel for a subwoofer.

Enjoy optimal sound reproduction from your system with a Dolby Digital amplifier that incorporates a digital coaxial input. Connect an optional digital cable directly to the television's Coax audio output to listen through all inputs except VGA.

**NOTE:** The VGA does not support digital audio.

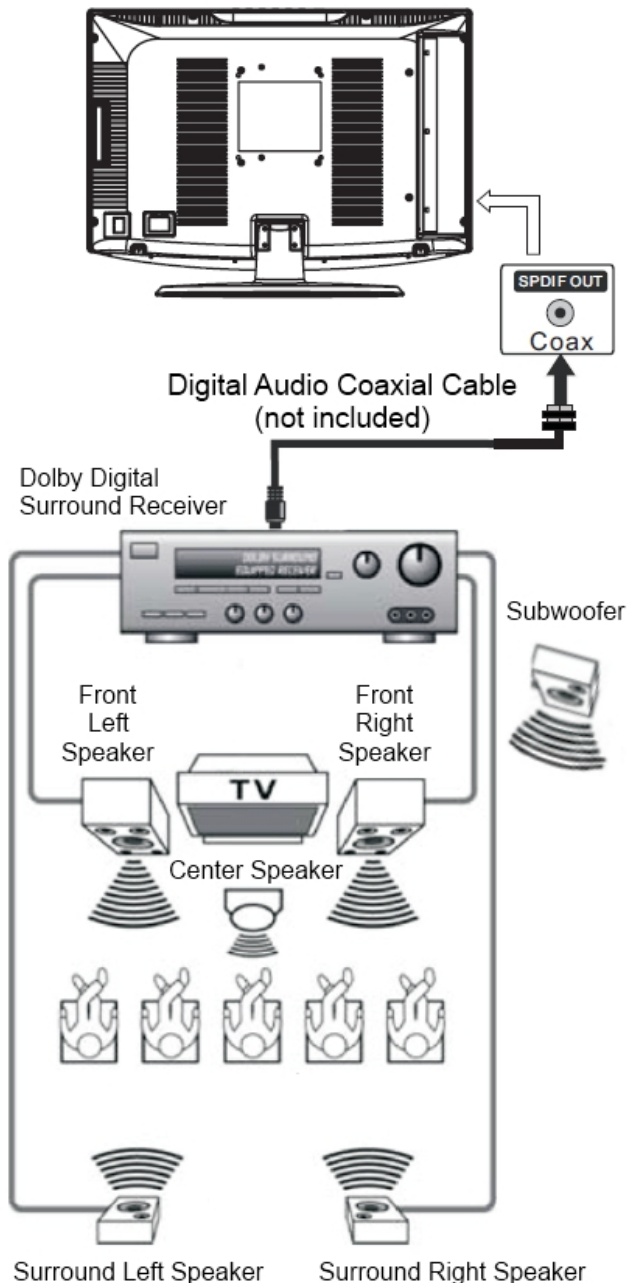

### How to Setup Digital Output

Press the MENU button on the remote control.

Press the right ► arrow button to select SOUND

Press the down ▼ arrow button to highlight SPDIF type right ► Raw or PCM.



\* NOTE: refer to the user manual of your Home Theater System for recommended audio settings.

## PUTTING THE UNIT ON A PROPER SURFACE

When you turn on your television set for the first time, be sure to place it on a solid stable, surface.

To avoid danger, do not expose the TV to water, or a heat source (i.e. lamp, candle, radiator).

Do not obstruct the ventilation grid at the rear and be sure to leave sufficient gaps around the unit.

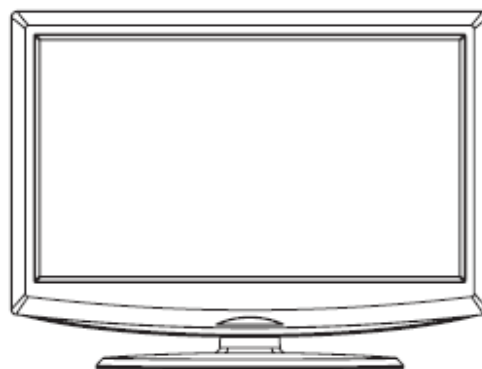

## TURNING THE TV ON FOR THE FIRST TIME

After you have initially connected your TV antenna or cable, press POWER button to turn the television ON.

A screen will display asking you to run a Channel Auto Scan to search and receive available local digital channels.

It is here where you will select antenna options and run Channel Auto Scan.

Channels will then be stored in the TV tuner.

Press the MENU button on the remote control.  
Using the ◀ / ▶ buttons, scroll to highlight channel mode.  
Press the ▼ button to highlight AIR/CABLE.



## SOURCE SELECT

1. Press the SOURCE button on the remote control.
2. Use the ▲ or ▼ button to select the options: TV, AV, Component, HDMI, PC and Media.
3. Select any of them using the ENTER button and the screen will change to your desired source.

### NOTE:

Before attempting to watch TV, please make sure all necessary cables and devices are connected.

If the unit cannot detect a valid video signal on the selected input source, it will return to standby mode automatically in 15 minutes for energy saving.

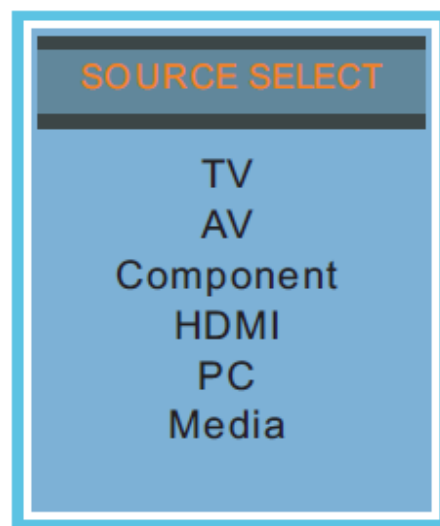

## CHANNEL MENU

Press MENU button to display the main menu.

Press ◀ / ▶ button to select CHANNEL in the main menu. It will highlight the first option.



### AIR / CABLE

This feature allows you to switch between air (such as using antenna) and cable.

### AUTO SCAN

This feature searches channels automatically for you.

### FAVORITES

This feature gives the favorite list of channels added by you.

### CHANNEL LIST

This feature shows the list of stored channels.

### SHOW / HIDE

This feature tells you if you have chosen for channel to be skipped.

### CHANNEL NUMBER

This feature tells you what channel you are currently on.

### CHANNEL LABEL

This feature changes the name of the channel.

### NOTE:

The channel options are only available when you select TV as your SOURCE. When you open the OSD menu on other sources (HDMI, AV, Component, PC, Media) these options will be grayed out.

## PICTURE MENU

Press MENU button to display the main menu.

Press ◀ / ▶ button to select PICTURE in the main menu. It will highlight the first option.



### PICTURE MODE

This feature changes various color modes for the TV

### BRIGHTNESS

This feature changes the picture's detail in dark colors.

### CONTRAST

This feature changes the difference between dark and bright objects.

### COLOR

This feature changes the amount of color in the picture.

### TINT

This feature changes the white balance of the color.

### SHARPNESS

This feature changes the picture quality.

### COLOR TEMPERATURE

This feature adjusts the color temperature of the TV, giving Warm, Normal, and Cool options.

### ADVANCED SETTINGS

#### (a) ASPECT RATIO

This feature changes the various aspects of the TV's video, giving Wide, Zoom, Cinema and Normal options.

#### (b) NOISE REDUCTION

This feature reduces general pixilation by blurring them, giving Medium, High, Off and Low options.

#### (c) DYNAMIC CONTRAST

This feature allows the TV to automatically adjust the contrast of the TV depending on the picture you are viewing.

## SOUND MENU

Press MENU button to display the main menu.

Press ◀ / ▶ button to select SOUND in the main menu. It will highlight the first option.



### EQUALIZER SETTINGS

This feature enables the internal equalizer of the speakers.

You can adjust the settings individually or use the presets (Standard, Music, Movie, Sports and User).

### MTS

This feature adjusts the second audio programming in analog channels, giving Mono, Stereo and SAP options.

### AUDIO LANGUAGE

This feature adjusts the digital second audio programming in digital channels.

### DIGITAL AUDIO OUTPUT

This feature adjusts the digital audio output, giving PCM, Raw and Off options.

### SURROUND SOUND

This feature adjusts the dimensional surround effect On or Off (for built-in speakers only).

### AVL

This feature adjusts the auto volume leveler enabling volume protection from excessively loud commercials.

### NOTE:

AUDIO LANGUAGE and MTS are dependent on the broadcasting station's support and are only available under the source TV.

## TIME MENU

Press MENU button to display the main menu.

Press ◀ / ▶ button to select TIME in the main menu. It will highlight the first option.



### SLEEP TIMER

This timer automatically turns off the TV at the designated time. Options are Off, 5, 10, 15, 30, 60, 90, 120, 180 and 240 minutes.

### TIME ZONE

This option adjusts the global time zone for the TV, giving Pacific, Alaska, Hawaii, Samoa, Newfoundland, Atlantic, Eastern, Central and Mountain options.

### DAYLIGHT SAVING TIME

This option toggles the daylight saving time feature On or Off.

### TIME FORMAT

This option adjusts the display format for the time. (i.e. Under 24 hour format 1:00PM would display as 13:00).

### AUTO CLOCK

This option enables the TV to sync time with the antenna.

(Put it on AUTO if you have an antenna attached to the TV. If you have CABLE or SATELLITE or anything else please make sure AUTO CLOCK is turned off)

### CLOCK

This option allows you to adjust the date and time of the TV manually. You need to disable AUTO CLOCK in order to use this function.

### NOTE:

The TIME function will keep accurate time only if the TV remained plugged into a live AC power source. If the TV is unplugged or the power strip is turned off, the TV's time may not be accurate. Please set up the correct date and time manually if necessary.

## SETUP MENU

Press MENU button to display the main menu. Press ◀ / ▶ button to select SETUP in the main menu, it will highlight the first option.



### MENU LANGUAGE

This feature changes the language of the TV's OSD menu, giving English, Français and Español options.

### TRANSPARENT

This feature changes the transparency of the menu allowing background TV images to show through, giving 0, 25%, 50%, 75% and 100% options.

### OSD TIMEOUT

This feature changes the time which the TV's OSD menu automatically goes off, giving 5, 15, 30, 45 and 60 seconds.

### CLOSED CAPTION

This option displays words on the TV, giving optional settings for CC mode, Analog CC and Digital CC.

### INPUT LABEL

This option changes the source names to your personal preference.

### OTHER SETTINGS

It provides the AUDIO ONLY option which turns off the screen while the audio is still playing.

### RESTORE DEFAULT

This option restores all the personal settings in the OSD menu back to the default factory settings.

### SETUP WIZARD

This option enables the TV to show you the setup wizard of the TV again.

### NOTE:

Closed captioning is only available under AV and TV ports.

Closed captioning depends on your TV program's support. Sometimes due to the TV channel or the signal, closed captioning will not be available.

In the United States, closed captioning under analog signals is CC1 and digital signal is Service1.



## LOCK MENU

Press MENU button to display the main menu.

Press ◀ / ▶ button to select LOCK in the main menu. It will highlight the first option.

Press "0000" for the default unlock password.

The Input Block down to Reset RRT options will appear only after the System Lock option is set to On.

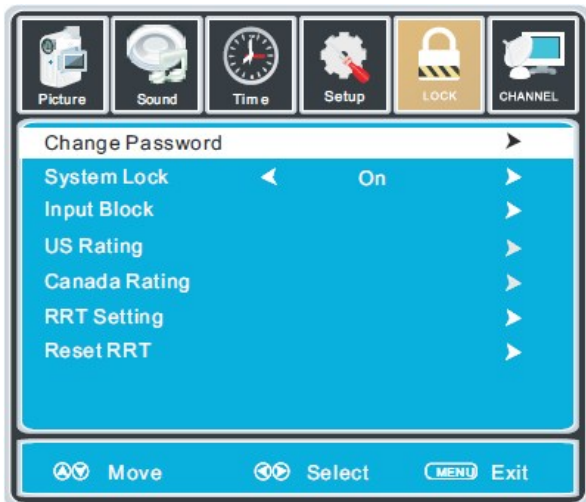

### CHANGE PASSWORD

This option allows you to change the LOCK menu password.

### SYSTEM LOCK

This option enables parental locking and filtering for the TV.

### INPUT BLOCK

This option disables the connection ports of your choice, i.e. If the DVD player is connected to HDMI and you use INPUT BLOCK to block HDMI, you will not be able to see anything from HDMI.

### US RATING

This option filters US TV programming and movies.

### CANADA RATING

This option filters CANADA TV ratings.

### RRT SETTING

This feature is a downloadable rating filter based on TV broadcasts. With the transition of TV broadcasts to digital, future changes, and enhancements in how TV shows are rated for content are possible.

### RESET RRT

This option resets the RRT5 settings.

### NOTE:

Please refer to V-CHIP TV RATING EXPLANATIONS and MPAA US MOVIE RATINGS EXPLANATIONS sections for more information on ratings definitions.

Downloadable rating and clear downloadable data might be grayed out depending on the TV station's support.

RRT5 options are based on TV broadcasts. If it is grayed out, then it is not available in your region.

## MEDIA

The TV has a USB port on its side panel as shown below.

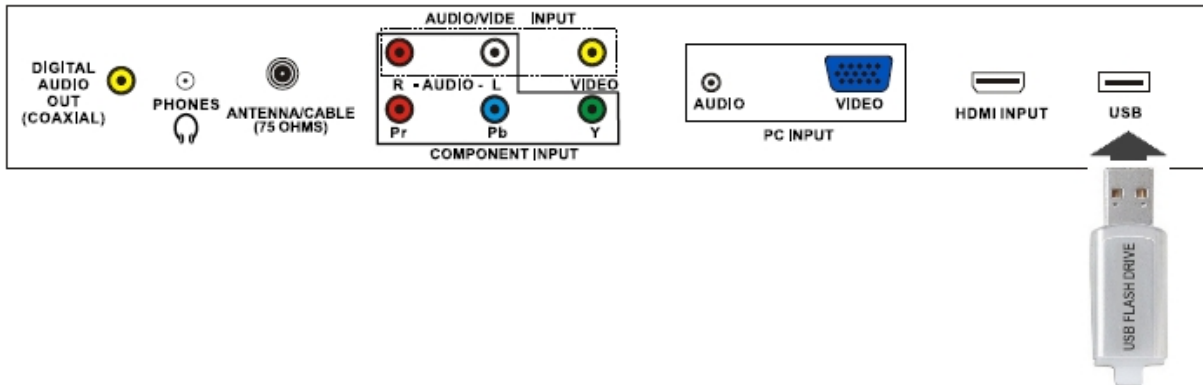

It can access USB flash drive and display pictures or playback MP3 songs contained in it. Simply connect a USB flash drive to the USB port and press the USB button to start browsing for music and pictures.

### Browsing Music and Photo:

In the USB function, select Music or Photo. Use the ▲/▼/◀/▶ button to select the folder or file you want and press the ENTER button to play the file. Use the EXIT button to exit a folder and return to the previous menu.

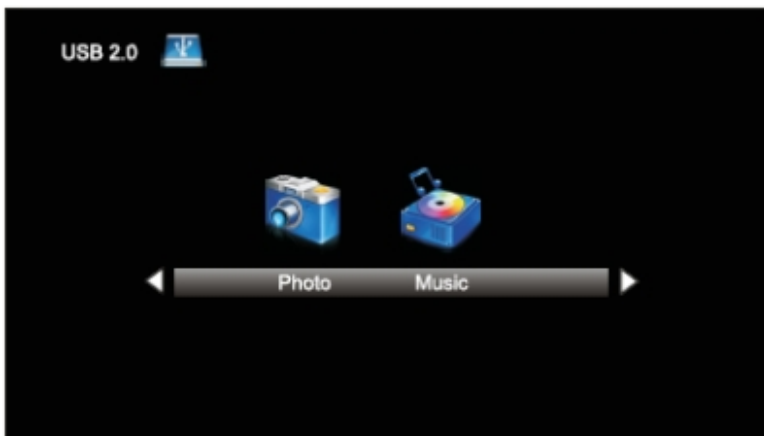

### Technical Limitations:

- The USB port also supports a USB 2.0 SD card reader but does not support a USB hub.
- The USB flash drive supports FAT32 and FAT16 file systems only.
- The biggest file size is 4 GB in FAT32 file system.
- The Photo function only supports JPEG files (baseline only, progressive is not supported).
- The Music function only supports MP3 files having a sampling rate of 32 - 48kHz and data rate of 32 - 320 kbps.
- All USB functions are operated by the remote control. None of the buttons physically located on the TV will respond to USB functions.

## DISPLAY MODES

### DIGITAL VIDEO FORMATS

<b>SUPPORTED COMPONENT AND HDMI INPUT MODES</b>			
Resolution	Horizontal Scanning Frequency (kHz)	Vertical Scanning Frequency (Hz)	Format
720 x 480	31.47	59.94	480i
720 x 480	15.734	59.94	480p
1280 x 720	37.50	50.00	720p
1280 x 720	45.00	60.00	720p
1920 x 1080	31.25	50.00	1080i
1920 x 1080	33.75	60.00	1080i
1920 x 1080	27.00	24.00	1080p
1920 x 1080	56.25	50.00	1080p
1920 x 1080	67.50	60.00	1080p

**NOTE:**

The above listed formats are also related to the AV devices you are about to connect with. Before you connect this TV with other devices, please read all instructions carefully and make sure all necessary cables are properly connected. This TV may not be compatible with some other formats that do not meet the above conditions.

### PC VIDEO FORMATS

<b>SUPPORTED PC INPUT MODES</b>			
Resolution	Horizontal Scanning Frequency (kHz)	Vertical Scanning Frequency (Hz)	Format
640 x 480	31.50	60.00	DOS
800 x 600	35.10	56.20	VESA
800 x 600	37.90	60.00	VESA
1024 x 768	48.40	60.00	VESA
1366 x 768	47.70	60.00	VESA

**NOTE:**

This product does not support the display mode if it is not listed above. For best display effect, select from the display mode input signals listed. The output signal varies depending on the display driver and may cause interference, which can be adjusted with the "AUTO" button on the PC menu.

## CLEANING

- To clean this unit, wipe with a soft, dry and lint-free cloth.
- If the surfaces are extremely dirty, wipe gently with a soft cloth moistened (never wet) in a soap and water solution or a weak detergent solution.
- Use only good quality cleaner specifically formulated to clean the LCD panel to remove stubborn dirt from the TV screen surface.
- Never use alcohol, paint thinner or other organic solvents to clean this unit. They can cause permanent damage to your TV parts and finishing.
- Before using a chemically treated cloth, read the instructions that came with the cloth carefully.

## TROUBLESHOOTING

SYMPTOM	CAUSE / REMEDY
TV does not power ON	<ul style="list-style-type: none"> <li>- Make sure power cord is securely connected.</li> <li>- Unplug power cord from the outlet. Wait one minute and reconnect.</li> </ul>
TV is ON but no picture or sound	<ul style="list-style-type: none"> <li>- Make sure the TV mode is selected.</li> <li>- Try a new channel to check for possible station trouble.</li> <li>- Make sure the antenna or audio/video source is connected and working properly.</li> <li>- Make sure all cables are firmly connected.</li> <li>- Check for sources of local interference.</li> </ul>
Distorted picture when first turning on the power	<ul style="list-style-type: none"> <li>- May be caused by very short interval of time between the TV being powered OFF. and then ON again. Unplug the power to the TV and then plug in again.</li> </ul>
Bad TV Picture (snow, multiple images, distortion, blurry) (For analog TV reception only)	<ul style="list-style-type: none"> <li>- Check the location of the antenna and adjust if necessary.</li> <li>- Make sure the antenna cable is firmly connected.</li> <li>- Make sure all input cables from all devices are firmly connected.</li> </ul>
Only getting black and white picture on the screen	<ul style="list-style-type: none"> <li>- Check the PICTURE setting within the PICTURE menu.</li> <li>- Make sure the program you are watching is indeed being broadcast in color.</li> </ul>
TV is ON and has picture but no sound	<ul style="list-style-type: none"> <li>- Check to see the volume is not set to "0" and increase the volume to desired level.</li> <li>- Check whether the mute function has been activated.</li> <li>- Check to see that all cables are properly connected.</li> </ul>
TV is ON and has picture but sound quality is poor	<ul style="list-style-type: none"> <li>- Check that all sounds settings are done correctly.</li> <li>- If sound is coming from just one speaker, adjust sound balance control to the center.</li> </ul>
Top and/or Screen of TV are warm to the touch after several hours of continuous use	<ul style="list-style-type: none"> <li>- This is due to normal power dissipation of the working electrical parts inside the TV and is not a defect in the product. To prevent potential overheating, make sure the ventilation slots are not blocked.</li> </ul>
Remote control is not working properly	<ul style="list-style-type: none"> <li>- Make sure batteries are installed properly.</li> <li>- Replace batteries if they are weak.</li> <li>- Clean the remote control and TV sensor lens.</li> <li>- Make sure there is no object between remote control and TV.</li> </ul>
Unable to select a certain channel	<ul style="list-style-type: none"> <li>- The channel may have been skipped during auto tuning setup. Choose the desired channel by directly selecting the channel using the number keys on the remote control.</li> </ul>
Panel function key does not respond correctly	<ul style="list-style-type: none"> <li>- Reset the TV by unplugging the AC cord for 5 minutes or more and then reconnecting.</li> </ul>
Problem with HDMI devices	<ul style="list-style-type: none"> <li>- If the TV does not recognize a certain HDMI device and no picture is displayed, try switching from one device to another and then back again.</li> <li>- If there are audio issues, check that output settings of the HDMI device are set properly.</li> </ul>
Problem with computer image on the TV	<ul style="list-style-type: none"> <li>- Check that your PC uses the supported resolution and format available with this TV</li> <li>- Try other picture formats by pressing the ASPECT button repeatedly.</li> </ul>
Unusual dots appear on the screen	<ul style="list-style-type: none"> <li>- In rare case, black dots and bright spots may appear on the LCD screen. This is a structural property of the LCD panel and not considered as a defect unless those dots appear in a cluster of two or three together.</li> </ul>

## SPECIFICATIONS

<b>PANEL</b>	Panel Type	LCD Panel
	Diagonal Size	18.5 inches
	Screen Format	16:9
	Resolution	1366 (H) x 768 (V)
	Brightness	250 nits
	Contrast	1000:1
	View Angle	170° (H) / 170° (V)
	Response Time	5 ms
	Color Depth	16.7 million colors
<b>SYSTEMS</b>	Digital TV Tuner	ATSC
	Digital TV Video System	MPEG-2 MP@HL
	Digital TV Sound System	AC-3
	Analog TV Video System	NTSC
	Analog TV Sound System	M / MTS
	Number of Channels	AIR : 69 CABLE : 135
	Audio Output Power	2 x 3W
<b>INPUTS &amp; OUTPUTS</b>	Antenna Input	75Ω F type female connector
	HDMI Input	HDMI connector Video formats supported: 480i, 480p, 720p, 1080i & 1080p Audio: 2-channel LPCM 32 - 44.1 & 48kHz, 16, 20 and 24 bits
	Component Video Input	RCA jacks (Green / Blue / Red) Y: 1.0 Vp-p (75Ω), 0.3 V negative sync Pb: 0.7 Vp-p (75Ω) Pr: 0.7 Vp-p (75Ω)
	Composite Video Input	RCA jack (Yellow) 1.0 Vp-p (75Ω)
	PC - RGB Input	D-sub 15pin socket R: 0.7 Vp-p (75Ω) G: 0.7 Vp-p (75Ω) B: 0.7 Vp-p (75Ω)
	Digital Audio Output	RCA jack (Orange) 500 mVp-p (75Ω)
	Stereo Audio Input	RCA jacks (White / Red) for; - L/R Audio (CVBS/Component inputs) - PC Audio 500 mVrms (20kΩ)
	Headphone Output	3.5 mm 100-150 mV
	USB Input	A-type female connector Max. file size: 4 GB File systems supported: FAT16 or FAT32 File types supported: JPEG image and MP3 audio
	<b>POWER</b>	Power Requirements
Power Consumption		28 W
<b>OTHERS</b>	Operating Temperature	41°F (5°C) to 104°F (40°C)
	Storage Temperature	32°F (0°C) to 122°F (50°C)

**NOTE:** Specifications are subject to update without prior notice.

## V-CHIP TV RATING EXPLANATIONS

### US V-Chip TV Rating System:

**TV-MA (Mature Audience Only)** - Specifically designed to be viewed by adults and may be unsuitable for children under 17. It contains one or more of the following content themes: crude indecent language (L), explicit sexual activity (S), or graphic violence (V).

**TV-14 (Parents Strongly Cautioned)** - Contains some material that many parents would find unsuitable for children under 14. Parents are strongly urged to exercise greater care in monitoring this program and are cautioned against letting children under the age of 14 watch unattended. This program contains one or more of the following content themes: intensely suggestive dialogue (D), strong coarse language (L), intense sexual situations (S), or intense violence (V).

**TV-PG (Parental Guidance Suggested)** - Contains material that parents may find unsuitable for younger children. Many parents may want to watch it with their younger children. The program contains one or more of the following content themes: some suggestive dialogue (D), infrequent coarse language (L), some sexual situations (S), or moderate violence (V).

**TV-G (General Audience)** - Most parents would find this program suitable for all ages. It contains little or no sexual dialogue (D) or situations (S), no strong language (L), and little or no violence (V).

**TV-Y7 (Directed to Children 7 years and older)** - Designed for children ages 7 and above. It may be more appropriate for children who have acquired the developmental skills needed to distinguish between make believe and reality. Themes and elements in this program may include mild fantasy violence (FV) or comedic violence, or may frighten children under the age of 7.

**TV-Y (All Children)** - Themes and elements in this program are designed for a young audience, including children ages 2-6. It is not expected to frighten younger children.

### Canadian English V-Chip TV Rating System:

**18+ (Adult)** - Programming intended for adults 18 and older. It may contain elements of violence, language, and sexual content which could make it unsuitable for viewers under 18. Violence Guidelines: May contain violence integral to the development of the plot, character or theme, intended for adult audiences. Other Content Guidelines: May contain graphic language and explicit portrayals of nudity and/or sex.

**14+ (Viewer 14 and over)** - Programming contains themes or content which may not be suitable for viewers under the age of 14. Parents are strongly cautioned to exercise discretion in permitting viewing by pre-teens and early teens. Violence Guidelines: May contain intense scenes of violence. Could deal with mature themes and societal issues in a realistic fashion. Other Content Guidelines: May contain scenes of nudity and/or sexual activity. There could be frequent use of profanity.

**PG (Parental Guidance)** - Programming intended for a general audience but which may not be suitable for younger children (under the age of 8). Parents may consider some content inappropriate for unsupervised viewing by children aged 8-13. Violence Guidelines: Depictions of conflict and/or aggression will be limited and moderate; may include physical, fantasy, or supernatural violence. Other Content Guidelines: May contain infrequent mild profanity, or mildly suggestive language. Could also contain brief scenes of nudity.

**G (General Audience)** - Programming considered acceptable for all ages groups. While not designed specifically for children, it is understood younger viewers may be part of the audience. Violence Guidelines: Will contain very little violence, either physical or verbal or emotional. Will be sensitive to themes which could frighten a younger child, will not depict realistic scenes of violence which minimize or gloss over the effects of violent acts. Other Content Guidelines: There may be some inoffensive slang, no profanity and no nudity.

**C8+ (Children 8 and older)** - Programming generally considered acceptable for children 8 years and over to watch on their own. Violence Guidelines: Violence will not be portrayed as the preferred, acceptable, or only way to resolve conflict or encourage children to imitate dangerous acts which they may see on television. Any realistic depictions of violence will be infrequent, discreet, of low intensity and will show the consequences of the acts. Other Content Guidelines: There will be no profanity, nudity or sexual content.

**C (Children)** - Programming intended for children under age 8. Violence Guidelines: Careful attention is paid to themes which could threaten children's sense of security and well being. There will be no realistic scenes of violence. Depictions of aggressive behavior will be infrequent and limited to portrayals that are clearly imaginary, comedic or unrealistic in nature. Other Content Guidelines: There will be no offensive language, nudity or sexual content.

### Canadian French V-Chip TV Rating System:

**18+ (Adult)** - Programming is for adults only. This program contains sustained violence or extremely violent scenes.

**16+ (Viewer 16 and over)** - Programming is not suitable for those under age 16. This program contains frequent scenes of violence or intensely violent scenes.

**13+ (Viewer 13 and over)** - Programming may not be suitable for children under the age of 13. This program either contains several violent scenes or one or more scenes that are violent enough to affect them. Viewing in the company of an adult is therefore strongly recommended for children under the age of 13.

**8+ (Viewer 8 and over)** - Not recommended for young children. This program is suitable for most audiences, but it contains mild or occasional violence that could upset young children. Viewing in the company of an adult is therefore recommended for young children (under the age of 8) who do not distinguish between reality and imagination.

**G (General Audience)** - This program is suitable for audiences of all ages. It contains no violence, or any violence that it does contain is either minimal or is presented in a humorous manner, as a caricature, or in an unrealistic way.

## MPAA US MOVIE RATING EXPLANATIONS



**G — General Audiences. All Ages Admitted.** A G-rated motion picture contains nothing in theme, language, nudity, sex, violence or other matters that, in the view of the Rating Board, would offend parents whose younger children view the motion picture. The G rating is not a "certificate of approval," nor does it signify a "children's" motion picture. Some snippets of language may go beyond polite conversation but they are common everyday expressions. No stronger words are present in G-rated motion pictures. Depictions of violence are minimal. No nudity, sex scenes or drug use are present in the motion picture.

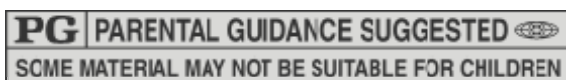

**PG — Parental Guidance Suggested. Some Material May Not Be Suitable For Children.** A PG-rated motion picture should be investigated by parents before they let their younger children attend. The PG rating indicates, in the view of the Rating Board, that parents may consider some material unsuitable for their children, and parents should make that decision. The more mature themes in some PG-rated motion pictures may call for parental guidance. There may be some profanity and some depictions of violence or brief nudity. But these elements are not deemed so intense as to require that parents be strongly cautioned beyond the suggestion of parental guidance. There is no drug use content in a PG-rated motion picture.



**PG-13 — Parents Strongly Cautioned. Some Material May Be Inappropriate For Children Under 13.** A PG-13 rating is a sterner warning by the Rating Board to parents to determine whether their children under age 13 should view the motion picture, as some material might not be suited for them. A PG-13 motion picture may go beyond the PG rating in theme, violence, nudity, sensuality, language, adult activities or other elements, but does not reach the restricted R category. The theme of the motion picture by itself will not result in a rating greater than PG-13, although depictions of activities related to a mature theme may result in a restricted rating for the motion picture. Any drug use will initially require at least a PG-13 rating. More than brief nudity will require at least a PG-13 rating, but such nudity in a PG-13 rated motion picture generally will not be sexually oriented. There may be depictions of violence in a PG-13 movie, but generally not both realistic and extreme or persistent violence. A motion picture's single use of one of the harsher sexually-derived words, though only as an expletive, initially requires at least a PG-13 rating. More than one such expletive requires an R rating, as must even one of those words used in a sexual context. The Rating Board nevertheless may rate such a motion picture PG-13 if, based on a special vote by a two-thirds majority, the Raters feel that most American parents would believe that a PG-13 rating is appropriate because of the context or manner in which the words are used or because the use of those words in the motion picture is inconspicuous.



**R — Restricted. Children Under 17 Require Accompanying Parent or Adult Guardian.** An R-rated motion picture, in the view of the Rating Board, contains

some adult material. An R-rated motion picture may include adult themes, adult activity, hard language, intense or persistent violence, sexually-oriented nudity, drug abuse or other elements, so that parents are counseled to take this rating very seriously. Children under 17 are not allowed to attend R-rated motion pictures unaccompanied by a parent or adult guardian. Parents are strongly urged to find out more about R-rated motion pictures in determining their suitability for their children. Generally, it is not appropriate for parents to bring their young children with them to R-rated motion pictures.



■ **NC-17 — No One 17 and Under Admitted.** An NC-17 rated motion picture is one that, in the view of the Rating Board, most parents would consider patently too adult for their children 17 and under. No children will be admitted. NC-17 does not mean "obscene" or "pornographic" in the common or legal meaning of those words, and should not be construed as a negative judgment in any sense. The rating simply signals that the content is appropriate only for an adult audience. An NC-17 rating can be based on violence, sex, aberrational behavior, drug abuse or any other element that most parents would consider too strong and therefore off-limits for viewing by their children

**X – Matured Audience Only.** (non MPAA rating) Only adults are allowed to watch these motion pictures.

## GLOSSARY

### **Aspect Ratio**

The ratio between the width and height of the TV picture on the screen. In a normal TV set, the aspect ratio is 4 to 3 (4:3). The new aspect ratio in HDTV is 16:9 which resembles the aspect ratio in a movie theatre (Widescreen). New TV systems support both 4:3 and 16:9 aspect ratio and can automatically switch between them.

### **ATSC (Advanced Television Systems Committee)**

Formed to establish technical standards for advanced television systems, including digital high definition television (HDTV).

### **Audio/Video (A/V)**

A term often used when discussing a channel on a TV receiver or on video equipment, which has been especially designed to accept audio-video signals. This channel automatically activates special circuitry within the TV set to prevent picture distortion and skewing. It is also used for audio-video processors, which handle both types of signals.

### **Component Video Input (Y Pb Pr)**

Component Video Input is a type of connection that uses a cinch-type connector to allow set top boxes or analog DVD players to connect a signal to the TV. By offering the cinch-type input (Y Pb Pr) the primary colors, red, green and blue are connected from a cable box directly into the TV allowing for the signal to display on the screen.

### **CVBS (Composite Video Baseband Signal)**

In broadcast television this refers to the video signal, including the color information and syncs.

### **Digital Tuner**

A digital tuner serves as the decoder required to receive and display digital broadcasts. It can be included inside TV sets or via a cable box.

### **DOLBY Digital**

The system developed by Dolby Laboratories to compress digital sound. It offers stereo sound (2 channel) or multi-channel audio (the six-channel digital audio standard that is part of the U.S. digital television standard; also called AC-3 or Digital 5.1). The channels consist of front left, front right, front center, surround or rear left, surround or rear right, and a separate subwoofer.

### **DTV (Digital television)**

Generic term that refers to all digital television formats, including high-definition television (HDTV) and standard-definition television (SDTV).



**HDMI (High-Definition Multimedia Interface)**

Interface that supports all uncompressed, digital audio / video formats including a cable box, Blu-ray / DVD recorder or digital television, over a single cable.

**HDTV**

The generally agreed upon definition of HDTV is approximately twice the vertical and horizontal picture resolution of today's NTSC TV, which essentially makes the picture twice as sharp. HDTV also has a screen ratio of 16:9 as compared with most of today's TV screens, which have a screen ratio of 4:3. HDTV offers reduced motion artifacts (i.e. ghosting, dot crawl), and offers 5.1 independent channels of CD-quality stereo surround sound, (also referred to as AC-3).

**NTSC (National Television System Committee)**

The organization that developed the analog television standard currently in use in the U.S., Canada, and Japan. Now generally used to refer to that standard. The NTSC standard combines blue, red, and green signals modulated as an AM signal with an FM signal for audio.

**Progressive Scan**

In Progressive Scanning all the horizontal scan lines are scanned on to the screen at one time. The Digital TV and HDTV Standards accept both Interlaced Scan and Progressive Scan broadcast and display methods.

**Resolution**

A measurement of the finest (smallest) detail that is visible in a video image. TV resolution may be expressed as number of pixels in an image, or more commonly, as total number of horizontally scanned lines used to create the image.

Standard Digital TV Resolutions:

SDTV - 480i - The picture is 704x480 pixels, 480p - The picture is 704x480 pixels.

HDTV - 720p - The picture is 1280x720 pixels

1080i - The picture is 1920x1080 pixels with interlaced scanning.

1080p - The picture is 1920x1080 pixels with progressive scanning.

**SAP (Secondary Audio Program)**

Second-audio channel delivered separately from main-audio channel.

This audio channel is used as an alternate in bilingual broadcasting.

**SPDIF (Digital Audio format)**

SPDIF (Sony and Philips Digital Interconnect Format) is highly recommended for high quality digital sound output.

## 90 DAY LIMITED WARRANTY AND SERVICE VALID IN THE U.S.A. ONLY

SPECTRA MERCHANDISING INTERNATIONAL, INC. warrants this unit to be free from defective materials or factory workmanship for a period of 90 days from the date of original customer purchase and provided the product is utilized within the U.S.A. This warranty is not assignable or transferable. Our obligation under this warranty is the repair or replacement of the defective unit or any part thereof, except batteries, when it is returned to the SPECTRA Service Department, accompanied by proof of the date of original consumer purchase, such as a duplicate copy of a sales receipt.

You must pay all shipping charges required to ship the product to SPECTRA for warranty service. If the product is repaired or replaced under warranty, the return charges will be at SPECTRA's expense. There are no other express warranties other than those stated herein.

This warranty is valid only in accordance with the conditions set forth below:

1. The warranty applies to the SPECTRA product only while:
  - a. It remains in the possession of the original purchaser and proof of purchase is demonstrated.
  - b. It has not been subjected to accident, misuse, abuse, improper service, usage outside the descriptions and warnings covered within the user manual or non-SPECTRA approved modifications.
  - c. Claims are made within the warranty period.
2. This warranty does not cover damage or equipment failure caused by electrical wiring not in compliance with electrical codes or SPECTRA user manual specifications, or failure to provide reasonable care and necessary maintenance as outlined in the user manual.
3. Warranty of all SPECTRA products applies to residential use only and is void when products are used in a nonresidential environment or installed outside the United States.

This warranty gives you specific legal rights, and you may also have other rights which vary from state to state. TO OBTAIN SERVICE please remove all batteries (if any) and pack the unit carefully and send it freight prepaid to SPECTRA at the address shown below. IF THE UNIT IS RETURNED WITHIN THE WARRANTY PERIOD shown above, please include a proof of purchase (dated cash register receipt) so that we may establish your eligibility for warranty service and repair of the unit without cost. Also include a note with a description explaining how the unit is defective. A customer service representative may need to contact you regarding the status of your repair, so please include your name, address, phone number and email address to expedite the process.

IF THE UNIT IS OUTSIDE THE WARRANTY PERIOD, please include a check for \$100.00 to cover the cost of repair, handling and return postage. All out of warranty returns must be sent prepaid.

It is recommended that you contact SPECTRA first at 1-800-777-5331 or by email at [custserv@spectraintl.com](mailto:custserv@spectraintl.com) for updated information on the unit requiring service. In some cases the model you have may be discontinued, and SPECTRA reserves the right to offer alternative options for repair or replacement.

SPECTRA MERCHANDISING INTERNATIONAL, INC.  
4230 North Normandy Avenue,  
Chicago, IL60634, USA.  
1-800-777-5331

To register your product, visit the link on the website below to enter your information.  
<http://www.spectraintl.com/wform.htm>

0812

Printed in China



**HELLO KITTY®**  
*by Sanrio®*

©1976, 2012 SANRIO CO., LTD.  
Used Under License.  
[www.sanrio.com](http://www.sanrio.com)



SIL-34037