



DA-5900

DIGITAL AUDIO CD RECORDER

**USER
MANUAL**



4X HIGH SPEED RECORDING TO AUDIO CD-R AND CD-RW DISCS

- DUB YOUR MUSIC
- RECORD FROM EXTERNAL SOURCES
- ANALOG AND DIGITAL INPUTS AND OUTPUTS
- FULL FUNCTION REMOTE CONTROL



Important Safety Instructions

This product has been designed and manufactured according to FCC regulations (title 21, CFR, chapter 1, subchapter J), and is classified as a class 1 laser product. This unit doesn't emit hazardous laser radiation during operation, because laser radiation is confined entirely in protective housings.

At the date of manufacture, this product complies with DHHS rules 21 CFR subchapter J.

Warning

- DO NOT REMOVE THE PROTECTIVE HOUSING.
- USE OF CONTROLS OR ADJUSTMENTS OTHER THAN THOSE SPECIFIED HERE MAY RESULT IN HAZARDOUS RADIATION EXPOSURE.
- IF THIS PRODUCT DEVELOPS TROUBLE, CONTACT THE DEALER FROM WHOM YOU BOUGHT IT. DO NOT USE THE UNIT IF IT SEEMS TO BE MALFUNCTIONING.

Caution

This equipment has been tested and found to comply with the limits for a Class B digital device, pursuant to Part 15 of the FCC Rules. These limits are designed to provide reasonable protection against harmful interference in a residential installation. This equipment generates, uses and can radiate radio frequency energy and, if not installed and used in accordance with the instructions, may cause harmful interference to radio communications. However, there is no guarantee that interference will not occur in a particular installation. If this equipment does cause harmful interference to radio or television reception, which can be determined by turning the equipment off and on, the user is encouraged to try to correct the interference by one of the following measures:

- Reorient or relocate the receiving antenna.
- Increase the separation between the equipment and receiver.
- Connect the equipment into an outlet on a circuit different from that to which the receiver is connected.
- Consult the dealer or an experienced radio/TV technician for help.

Any unauthorized changes or modifications to this equipment would void the user's authority to operate this device.

This device complies with Part 15 of the FCC Rules. Operation is subject to the following two conditions: (1) This device may not cause harmful interference, and (2) this device must accept any interference received, including interference that may cause undesired operation.



TO REDUCE THE RISK OF ELECTRIC SHOCK, DO NOT REMOVE COVER OR BACK. NO USER-SERVICABLE PARTS INSIDE.

Laser Diode Properties

Material: Ga-Al-As

Wavelength: 765-815nm (25°C) (play), 780-786nm (25°C) (record)

Laser Output: Continuous wave max. 5mW (play) Continuous wave max. 40mW (record)

Safety and Care Instructions

- **WATER AND MOISTURE:** Keep away from water and moisture. Avoid showers, bathtubs, sinks, swimming pools, open windows, rain, wet basements, etc.
- **HEAT:** Keep away from heat sources such as radiators, heat registers, stoves, amplifiers or similar devices.
- **TEMPERATURE AND HUMIDITY:** The nominal temperature should be between 5°C and 35°C (41°F and 95°F). This recorder is more sensitive to temperature extremes than play-only CD players. Relative humidity should be 30-90% non-condensing.
- **POWER SOURCES:** The product should be connected to a power supply only of the type described in the operating instructions or as marked on the product. The voltage supplied to the unit should match the voltage as printed on the rear panel. If you are in any doubt regarding this matter, consult an electrician.
- **GROUNDING OR POLARIZATION:** This product may be equipped with a polarized AC line plug (with one blade wider than the other), which fits into the outlet only one way. Do not defeat the safety purpose of this polarized plug.
- **LIGHTNING:** For added protection, unplug this unit during lightning storms.
- **VENTILATION:** Allow airflow to the system. Don't place on a closed bookcase or rack without proper ventilation. Do not place on top of a receiver or amplifier.
- **OBJECT AND LIQUID ENTRY:** Do not let objects fall into the system obstructing use. Avoid spilling liquids on the system.
- **POWER CORD PROTECTION:** Place power cords so that they are not stepped on, pinched, squeezed or pulled. Unplug the system if not in use for long periods of time.
- **ACCESSORIES:** Do not place this unit on an unstable cart, stand, tripod, bracket or table. The product may fall causing serious injury or death to a child or adult. Use only mounting accessories recommended by the manufacturer.
- **CLEANING:** Unplug the system from the power source and clean with a damp cloth. Do not use liquid or aerosol cleaners. To keep the laser pickup clean, do not touch it, and do not forget to close the disc tray.
- **SERVICING:** Do not service the system yourself. Servicing should be done by qualified personnel. For additional assistance call the dealer from whom you purchased the unit.
- **MOVING THE UNIT:** You should never move the unit while there is a disc inside one of the trays. Never move the unit until discs have been removed from both trays.

Table of Contents

DISC COMPATIBILITY & CARE	4
CONNECTIONS	5
REMOTE CONTROL	6
PLAYER BUTTON FUNCTIONS	7
REMOTE CONTROL BUTTON FUNCTIONS	8
PLAYBACK	9
REPEAT PLAYBACK	10
SHUFFLE PLAYBACK & INTRO CHECK	11
PROGRAMMED PLAYBACK	12
BEFORE RECORDING	13
DUBBING	14, 15
BASIC RECORDING	15
ADVANCED RECORDING	16, 17
FINALIZING DISCS	18
TIME DISPLAYS	19
PLAYER DISPLAY MESSAGES	20
ERROR MESSAGES	20
TROUBLESHOOTING	21
FRENCH DA-5900 USER MANUAL	25
SPANISH DA-5900 USER MANUAL	49

Disc Compatibility and Care

IMPORTANT CD RECORDING INFORMATION



This unit plays all audio CDs. For recording, the unit uses special audio-only CD-R or CD-RW discs. CD-R OR CD-RW DISCS DESIGNED FOR COMPUTER USE WILL NOT RECORD IN THIS UNIT.



Only discs bearing the CD-R Digital Audio or CD-RW Digital Audio logo can be recorded in this unit.

The last step in making a recording is the finalization process. Unless this step is completed, the disc will not work in other players or the DA-5900's TRAY I. Once finalized, CD-R discs will play in virtually any CD player. CD-RW discs will play in this unit and other CD-RW compatible players. Check the specifications of your CD player if you have questions about compatibility with CD-RW discs.

Once a CD-R disc has been finalized, it cannot be unfinalized. A finalized CD-RW disc can be unfinalized, allowing you to erase or add songs.

DISC CARE

- Always place the disc in the disc tray with the label facing up. (Compact discs can be played or recorded only on one side.)
- Never touch the recording (non-label) side of a disc. Recording requires a clean surface. Fingerprints, dust, grease, etc. can cause errors.
- If the disc surface becomes dirty, wipe it in an outward motion with a soft, dry cloth.
- Never use chemicals such as record sprays, anti-static sprays, benzine or thinner to clean a disc.
- To avoid dust and scratches that could cause skips, discs should be returned to their cases after use.
- Do not expose discs to direct sunlight or high humidity and temperatures for extended periods.
- CD-R and CD-RW discs are sensitive to the effects of heat and ultraviolet rays. It is important that they are not stored in a location where direct sunlight will fall on them, and which is away from sources of heat such as radiators or heat-generating electrical devices.
- Do not stick papers or protective sheets on the discs and do not use any protective coating spray.
- If you wish to label a CD-R/RW, only write on the label side, and use a soft-tip pen. Never use a ball-point or hard-tip pen.
- Never use a stabilizer. Using commercially available CD stabilizers with this unit will damage the mechanisms.
- Do not use irregularly shaped CDs (octagonal, heart-shaped, etc.).

Connections

The DA-5900 features a variety of audio inputs and outputs. For ideal sound quality, digital connections should be used for playback and recording.

You will want to connect your TDK Audio CD Recorder to an external device that will amplify the DA-5900's sound output. This device may be a receiver, a mini-system or a boombox, for example.

If your receiver or mini-system has audio output jacks, you may want to use it as an audio source for recording into your TDK Audio CD Recorder. You can also connect many devices, including most CD players and MiniDisc players directly to the DA-5900's inputs for recording. You CANNOT connect a turntable directly to your CD Recorder unless the turntable has a built-in preamplifier. (See the Advanced Recording section for more information on recording from a turntable.)

NOTE: Turn off the power of all your audio equipment before making connections.

For audio recording, connect a coaxial digital cable between the DA-5900's coaxial digital in jack and the coaxial digital out jack on a source device such as a MiniDisc player or a stereo receiver. Or connect an optical digital cable between the DA-5900's optical digital in jack and the optical digital out jack on a source device such as a MiniDisc player or stereo receiver. Note that the unit can only receive input through one jack (optical or coaxial) at a time.

[C] AC POWER CORD

Plug the power cord into an AC wall outlet.

HEADPHONE LISTENING

To listen through headphones, plug headphones into the unit's front-panel jack.

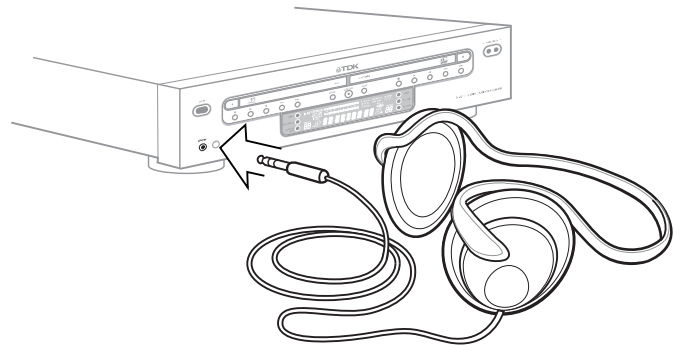
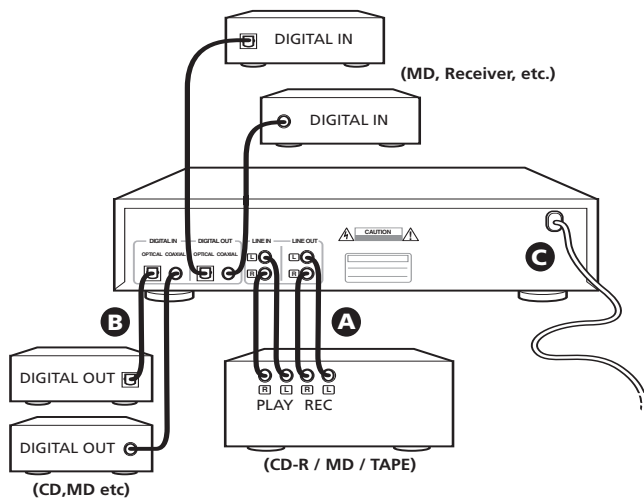

[A] LINE IN/LINE OUT

These analog jacks can be used for playback and recording. For audio playback, connect an analog cable (RCA type) between the DA-5700's line out jacks and the line in jacks on an amplification device such as a receiver. For audio recording, connect an analog cable (RCA type) between the DA-5900's line in jacks and the line out jacks on a source device such as a receiver or a tape deck.

[B] DIGITAL IN/OUT

The DA-5900 has optical and coaxial digital jacks for playback and recording. Both types of digital connections offer perfect signal transfer for the highest quality audio.

For audio playback, connect a coaxial digital cable between the DA-5900's coaxial digital out jack and the coaxial digital in jack on an amplification device such as a receiver. Or connect an optical digital cable between the DA-5900's optical digital out jack and the optical digital in jack on a playback device such as a receiver.

Remote Control

The supplied remote control allows the DA-5900 to be operated from a distance. When operating the remote control, point it towards the unit. Make sure nothing is blocking the recorder's display panel, behind which its remote control sensor is located.

BATTERY INSTALLATION

1. Remove the battery compartment cover.
2. Insert two AA batteries. Make sure that the batteries are inserted with their positive (+) and negative (-) poles positioned correctly.
3. Close the cover.

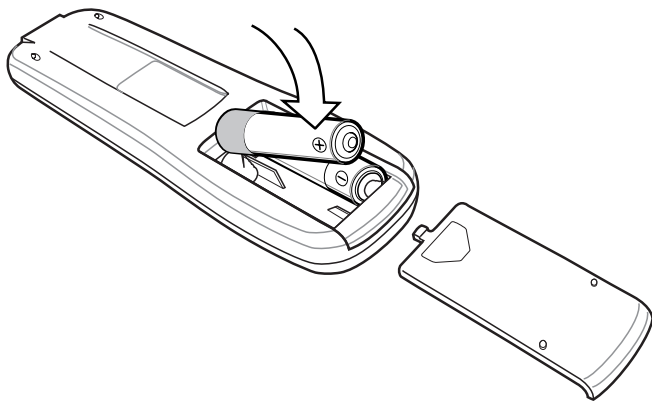

BATTERY REPLACEMENT

If you have to get closer than normal to the DA-5900 in order for the remote control to operate the unit, the batteries need to be replaced.

BATTERY PRECAUTIONS

- Never use different types of batteries together.
- Rechargeable or non-rechargeable batteries can be used separately.
- When the remote control will not be used for a long time (more than a month), remove the batteries to prevent leakage.
- If the batteries leak, use a cloth to wipe away the liquid inside the battery compartment and replace the batteries with new ones.
- Do not heat or disassemble batteries, and never dispose of old batteries by throwing them in a fire. Dispose of batteries according to the laws where you live.

Player Button Functions

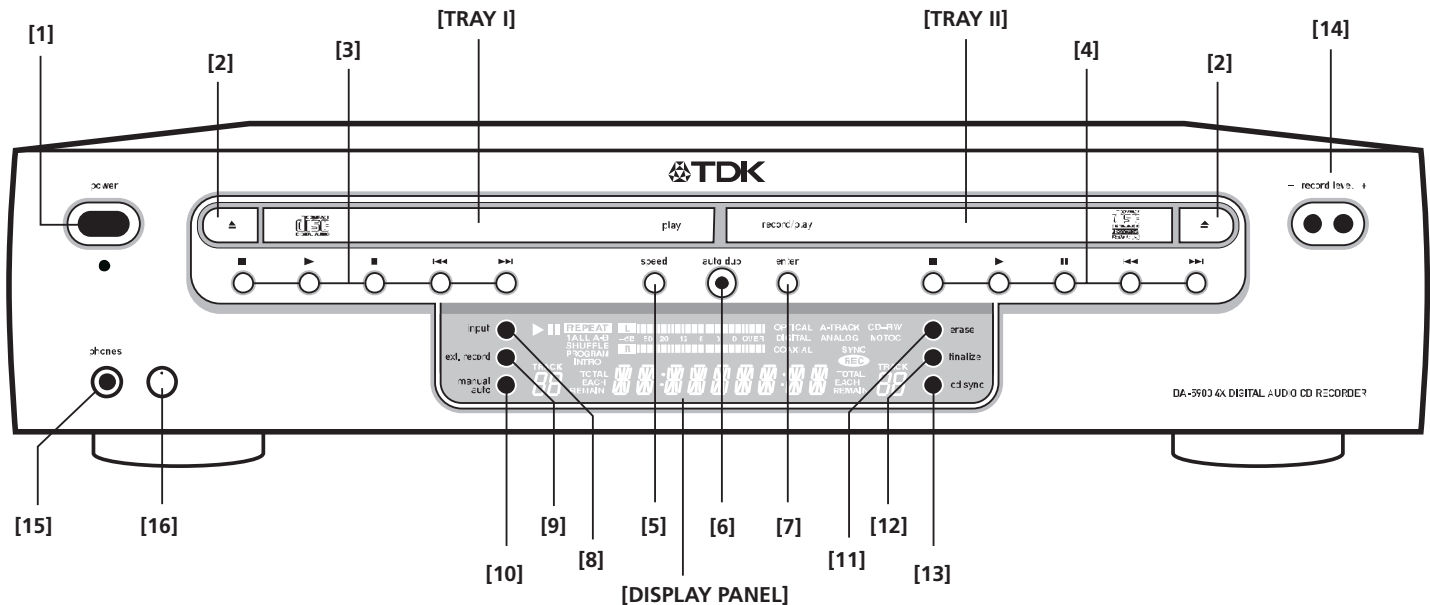

[1] POWER

Press to turn the power ON or OFF.

[2] TRAY OPEN/CLOSE (TRAY I AND TRAY II)

Press to open or close TRAY I or TRAY II.

[3] TRAY I PLAYBACK CONTROLS

STOP: [■]
Press to stop playback.

PLAY: [▶]
Press to start playback.

PAUSE: [⏸]
Press to pause playback.

TRACK SKIP: [⏮][⏭]
Press to skip tracks. Or press and hold down to scan forward or backwards within a track.

[4] TRAY II PLAYBACK CONTROLS

STOP: [■]
Press to stop playback or recording.

PLAY: [▶]
Press to start playback, recording, finalizing or erasing.

PAUSE: [⏸]
Press to pause playback or recording.

TRACK SKIP: [⏮][⏭]
Press to skip tracks. Or press and hold down to scan forward or backwards within a track.

[5] SPEED

Press to select the dubbing speed.

[6] AUTO DUB

Press to enter record pause mode. (Recording is armed, but does not start.)

[7] ENTER

Press to begin the recording process. (if recording has been armed).

[8] INPUT

Press to select the input (analog, coaxial digital or optical) through which you wish to record.

[9] EXTERNAL RECORD

Press to select recording from an external source.

[10] MANUAL / AUTO

Press to select automatic or manual track division.

[11] ERASE

Press to erase or unfinalize a disc. (Only CD-RW discs can be unfinalized.)

[12] FINALIZE

Press to finalize a CD-R or CD-RW disc.

[13] CD SYNC

Press to set up synchronized recording with an external digital source.

[14] RECORD LEVEL

Adjust to set the recording level from external sources.

[15] HEADPHONE JACK

Connect headphones for private listening.

[16] HEADPHONE VOLUME

Adjusts volume of headphone output.

Remote Control Button Functions

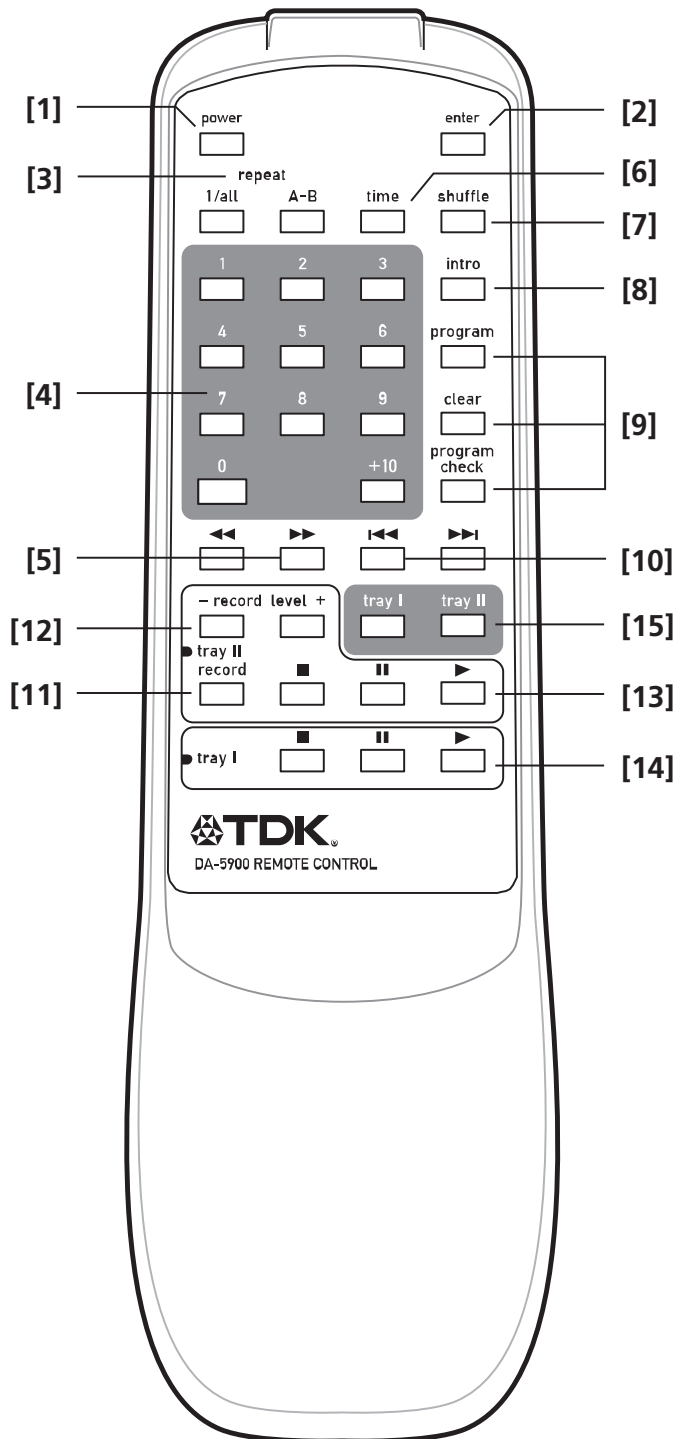

- [1] **POWER**
Press to power unit ON or OFF.
- [2] **ENTER**
Press to begin the recording process (if recording has been armed).
- [3] **REPEAT 1/ALL, A-B**
Press to set a repeat mode.
- [4] **NUMERIC BUTTONS**
Press to select track numbers.
- [5] **SEARCH [<<] [>>]**
Hold down to scan through a track.
- [6] **TIME**
Press to change the time display.
- [7] **SHUFFLE**
Press to set shuffle playback.
- [8] **INTRO**
Press to turn on INTRO CHECK function. The beginning of each track is played for 10 seconds when this mode is ON.
- [9] **PROGRAM, CLEAR, PROGRAM CHECK**
These buttons are used for programmed playback.
- [10] **TRACK SKIP [<<<] [>>>]**
Press to skip tracks.
- [11] **RECORD**
Press to enter record pause mode. (Recording is armed, but does not start.)
- [12] **RECORD LEVEL**
Adjust to set the recording level.
- [13] **TRAY II PLAYBACK CONTROLS**
 - PLAY [▶]
Press to start playback, recording, finalizing or erasing.
 - PAUSE [⏸]
Press to pause playback or recording.
 - STOP: [■]
Press to stop playback or recording.
- [14] **TRAY I PLAYBACK CONTROLS**
 - PLAY [▶]
Press to start playback.
 - PAUSE [⏸]
Press to pause playback.
 - STOP: [■]
Press to stop playback.
- [15] **TRAY I / TRAY II SELECTOR CONTROLS**
These buttons are used to select TRAY I or TRAY II. Before pressing the remote control's **TRACK SKIP** [<<<] [>>>], **MUSIC SEARCH** [<<] [>>] or numeric buttons, press either the **TRAY I** or **TRAY II** button to select which tray those buttons will control.

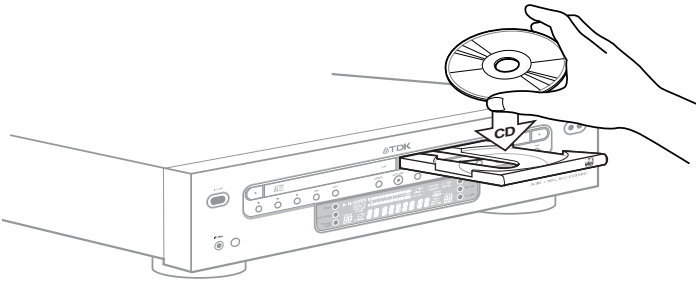

TRAY II can play back standard audio CDs, CD-R and CD-RW discs. TRAY I can play back standard audio CDs and finalized CD-R/CD-RW discs. Note that CD-R and CD-RW discs that haven't been finalized cannot be played in TRAY I.

1. Press the **POWER** switch to turn the unit ON.
The display briefly shows READING. When no disc is inserted, NO DISC DISC NO is shown on the display.
2. Press the **OPEN/CLOSE** [▲] button of TRAY I or TRAY II.
3. Place a disc in the tray, label side up.
4. Press the **OPEN/CLOSE** [▲] button of TRAY I or TRAY II. When a disc is loaded into the unit, the display shows READING as it determines the contents of the disc. When the TOC has been read, the display will show the following information:

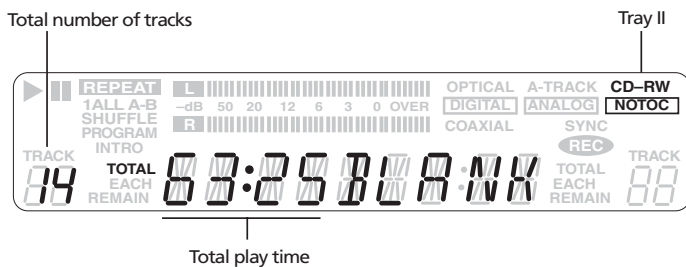

When a blank disc is placed in TRAY II, the display will show BLANK.

Here are other messages the display will show when a disc is placed in TRAY II:

- CD:** When a commercial pre-recorded CD or a finalized CD-R is inserted
- CD-R, NO TOC:** When a CD-R that hasn't been finalized is inserted
- CD-RW, NO TOC:** When a CD-RW that hasn't been finalized is inserted
- CD-RW:** When a finalized CD-RW is inserted
- BLANK:** When an unrecordable audio disc or no disc is inserted

5. Press the **PLAY** [▶] button of TRAY I or TRAY II to start playback.

To stop playback:
Press **STOP** [■].

To temporarily suspend playback:
Press **PAUSE** [⏸].

To resume playback where it was paused:
Press **PAUSE** [⏸] or **PLAY** [▶].

To restart playback at the beginning of a track that's currently playing:
Press the **TRACK SKIP BACK** [◀◀] button.

To return to the beginning of the previous track while a track is playing:
Quickly press the **TRACK SKIP BACK** [◀◀] button twice.

When using the remote control, remember to select TRAY I or TRAY II before using the **TRACK SKIP** [◀◀][▶▶] buttons.

To scan (search) through a track during playback:
If operating the unit from its front-panel:

Hold down the tray's **TRACK SKIP** [◀◀][▶▶] button until the section you want to hear is found.

If operating the unit from its remote control:

Select TRAY I or TRAY II, then press and hold the **SEARCH** [◀◀][▶▶] button.

DIRECT TRACK SELECT

1. Using the remote, press the I or II button to select the tray.
2. Enter the desired track number on the numeric keypad.
Playback will start from the selected track.
Note: To play tracks 1 through 9, simply press the appropriate button (1 through 9) on the remote's numeric keypad. To play a track numbered higher than 9, press the +10 button, followed by a numeric button.

If you press the numeric button while the unit is paused, the deck enters pause mode at the beginning of the selected track.

If a track number which doesn't exist on the disc is selected during TOC reading, the last track of the disc will be played.

Direct track selection isn't possible during shuffle playback and program playback.

Repeat Playback

Repeatedly pressing the remote control's REPEAT 1/ALL button changes the mode as follows:

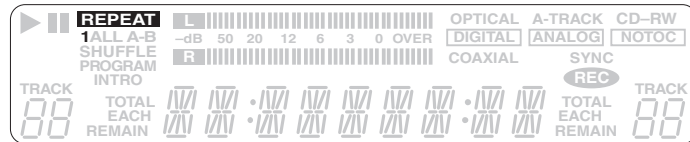

REPEAT 1

During playback, press the remote's **REPEAT 1/ALL** button, selecting REPEAT 1.

- The current track will play repeatedly.
- If you select another track while in REPEAT 1 mode, the track you select will be played repeatedly.

It is also possible to set REPEAT 1 mode while playback is stopped:

1. Press the **REPEAT 1/ALL** button.
2. Using the remote's numeric buttons, select the track number to play.

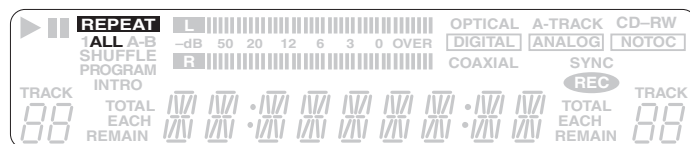

REPEAT ALL

During playback, press the remote's **REPEAT 1/ALL** button until REPEAT ALL is selected.

- All tracks on the disc will be played repeatedly.
- During program playback, only programmed tracks will be played repeatedly.
- When discs are in TRAY I and TRAY II, the unit will repeat all tracks on each disc for five cycles before stopping.

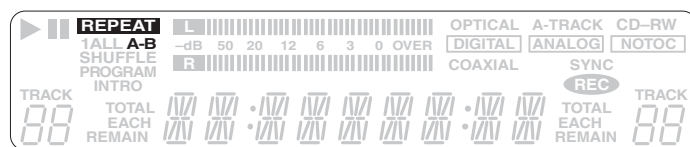

REPEAT A-B

This mode repeats a designated section of music. This mode cannot be used with unfinalized CD-R or CD-RW discs.

1. Start playback.
 2. When the beginning of the section of music you wish to repeat is reached, press the remote's A-B button.
 3. When the end of the section of music you wish to repeat is reached, press the remote's A-B button again.
- The selected section of music will now repeat.
 - Repeat A-B start and end points must be selected within the same track.
 - After designating point A, the remote's **SEARCH FORWARD [>>]** button can be used to fast-forward to where you want to set point B.

The following buttons will cancel REPEAT A-B mode:

- A-B
- STOP [■]
- OPEN/CLOSE [△]
- POWER

Shuffle Playback & Intro Check

SHUFFLE PLAYBACK

To activate this mode, press the remote's **SHUFFLE** button during playback.

- The tracks will be played randomly until every track has been played.
- If playable discs are in both trays, shuffle will randomly play all tracks from both discs.
- If you press **TRACK SKIP FORWARD** [▶▶] during SHUFFLE playback, the next randomly selected song will be played.
- If you press **TRACK SKIP BACKWARD** [◀◀] during SHUFFLE playback, the current track will replay from its beginning.
- To cancel SHUFFLE playback, press the **SHUFFLE** button.

INTRO CHECK

To activate this mode when playback is stopped, press the remote's **INTRO** button, then the **PLAY** [▶] button.

- The beginning of each track will play for 10 seconds.
- When a track you want to hear begins, press the **INTRO** button again, and the entire track will play.
- During program playback, the programmed tracks will be played for 10 seconds each.
- When all the tracks of both discs have been checked, intro check stops.
- To cancel the intro check mode, press the **INTRO** button again.
- If **INTRO** is pressed more than 10 seconds after playback of a song has begun, **INTRO CHECK** will start from the next track.

Programmed Playback

1. Press the remote's **PROGRAM** button. STEP 01 and PROGRAM will appear in the display and the track number 1 will blink.
2. Select the disc tray by pressing the remote's I or II button, then select a track by pressing the numeric buttons or the **TRACK SKIP** [◀◀][▶▶] buttons. If you make a mistake, press the numeric buttons again.
3. Press the **PROGRAM** button. The track is programmed, and the next step (STEP 02) is ready to be programmed.
4. Repeat items 2 and 3 to program additional tracks.
5. When you've finished adding tracks, press **STOP** [■].
6. Press **PLAY** [▶] to begin programmed playback.
7. After playback has stopped, additional tracks can be added by pressing **PROGRAM** and repeating items 2 and 3.

- The program list is kept in memory even if **STOP** [■] has been pressed.
- If the **PROGRAM** button is pressed without selecting a track number, the first song on the disc will be programmed.
- Up to 32 tracks from 2 discs can be programmed in the desired order. PGM FULL will appear when no more tracks can be programmed.
- Shuffle playback does not work during program playback.

To check the programmed track order:

When playback is stopped, repeatedly press the remote's **PROGRAM CHECK** button. The track numbers and program numbers will be shown on the display.

To change the program:

1. When playback is stopped, press **PROGRAM CHECK** until the program number you wish to change is selected.
2. Select a new track number by pressing the numeric buttons, then press the **PROGRAM** button to overwrite the program.

To delete a track:

1. When playback is stopped, repeatedly press the remote's **PROGRAM CHECK** button until the program number you wish to delete is displayed.
2. Press the **CLEAR** button to delete the track.

To clear the program:

- Press the **STOP** [■] button, then the **CLEAR** button.
- Or if playback is stopped, press the **CLEAR** button.
- Or press the **OPEN/CLOSE** [⏏] button.

Before Recording

Before you start recording, note the following points:

- The unit requires Digital Audio CD-R or Digital Audio CD-RW media for recording. Computer CD-R or CD-RW discs do not work with this unit. Only discs with the following logos can be recorded:



- Once you have recorded on a CD-R disc, the data cannot be erased from it.
- You can add tracks to an unfinalized CD-R or CD-RW disc. Once finalized, a CD-R disc cannot be changed. Finalized CD-RW discs, however, can be erased and re-recorded.
- Due to technical restrictions of CDs, a track cannot be less than four seconds in length, and there can be a maximum of 99 tracks on an audio CD.
- When the recording is finished, PMA WRITE and COMPLETE are displayed for a few seconds, then the unit stops. Make sure the unit doesn't vibrate during recording.
- If the end of a disc is reached during recording, the unit will do a fade-out over a few seconds. When the fade-out has finished, the unit will automatically finalize the disc and stop.
- When the number of tracks exceeds 99 during recording, the unit stops recording.
- The recording time of a track may slightly differ from that of the original one.
- Discs with HDCD logo will be recorded in the standard CD format.
- If you record a track with the Repeat 1 function enabled, the track number may not be incremented correctly.

ABOUT THE SERIAL COPY MANAGEMENT SYSTEM

This unit complies with the Serial Copy Management System (SCMS) standard. This standard was created to restrict digital-to-digital copying to only the first generation. The basic rules governing this system are as follows:

1. A digital recording can be made through a digital input connection from a digital source such as a CD, DAT or MD onto a recordable Audio CD-R, Audio CD-RW, MD or DAT. However, second and later generation copies cannot be recorded digitally.
2. When an analog source such as an FM broadcast is digitally recorded by using a CD-R, CD-RW, MD or DAT, this recorded source can be digitally recorded on another CD-R, CD-RW, MD or DAT. However, further digital copying is prohibited.

Dubbing

This section describes how to make a copy of a disc in TRAY I to an audio CD-R or CD-RW in TRAY II.

The DA-5900 has a convenient **AUTO DUB** button that makes it very easy to copy audio discs.

To Auto Dub an Entire Audio CD at 4X Speed:

1. Press **POWER** to turn the unit ON.
2. Place the disc to be dubbed in TRAY I, and put a recordable audio CD-R/RW disc in TRAY II.
3. Close both trays.
 - When the blank disc is inserted and TRAY II is closed, the display will show a **BLANK** message.
4. Press and hold in the **AUTO DUB** button for about three seconds.
 - The unit will dub the CD at 4X speed, then will automatically finalize your newly recorded disc.

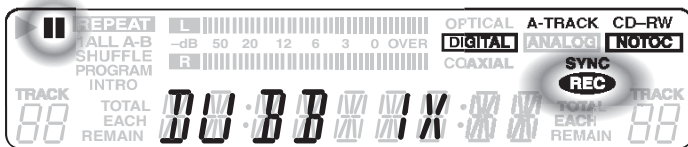
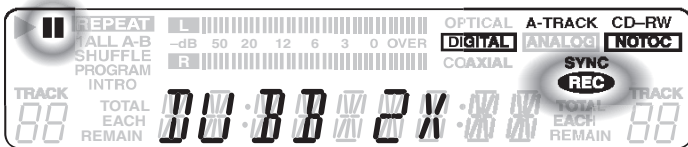
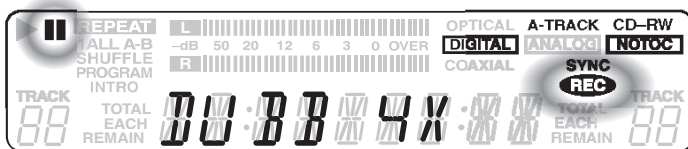

To Auto Dub an Entire Audio CD at 1X, 2X or 4X Speed:

1. Press **POWER** to turn the unit ON.
2. Place the disc to be dubbed in TRAY I, and put a recordable audio CD-R/RW disc in TRAY II.
3. Close both trays.
 - When the blank disc is inserted and TRAY II is closed, the display will show a **BLANK** message.
4. Press and quickly release the **AUTO DUB** button.
5. Press the **SPEED** button to select 1X, 2X or 4X dubbing speed.
 - Every time **SPEED** is pressed, the dubbing speed is changed.

DUBB 4X: records four times as fast as the normal playback speed
DUBB 2X: records twice as fast as the normal playback speed
DUBB 1X: records at normal playback speed

6. Press **ENTER**. The unit will dub the CD
7. Finalize your newly recorded disc.

To finalize a disc:

1. Load an unfinalized disc in TRAY II.
2. With playback stopped, press and hold in the **FINALIZE** button for three seconds.
 - Finalization will take about 60 seconds.

- If for some reason you wish to cancel the finalize process, press **STOP** [■].
- When the operation is finished, **COMPLETE** will appear briefly on the display, then the display will return to its track/time display mode.

NOTE: If the unit detects copy-prohibit signals when you're attempting dubbing, **SCMS** appears on the display, then the unit automatically dubs the disc in analog mode at 1X speed. The disc will be automatically finalized.

If the CD-R/RW disc in TRAY II doesn't have enough space to dub the entire disc in TRAY I, **NOSPACE:D2** and **DUBB 1/2/4X** will alternately appear on the display. Even if this happens, you can still dub most of the disc.

- To dub as much of the disc as possible, press the **ENTER** button when **DUBB 1/2/4X** is displayed.
- When the disc nears the end of its available recording space, the unit will do a fade-out over a few seconds.
- When the fade-out has finished, the unit will finalize the disc and automatically stop.
- Pressing **STOP** [■] will stop the dubbing process.
- When dubbing is stopped by pressing **STOP** [■], the disc will not be finalized.
- During dubbing, only the **STOP** [■] buttons of TRAY I and II will work.
- Track numbers are incremented automatically. During dubbing, you cannot add track numbers manually.
- Note that the unit is more tolerant of disc errors at slower dubbing speeds. If you're using low quality audio CD-R or CD-RW discs (or if your source disc is scuffed), and you're experiencing problems, record at 1X.
- If you intend to monitor the sound during high speed dubbing, turn the volume of your amplifier down low to prevent possible damage to your system.
- During high speed (2X or 4X) dubbing, **SYNC ALL** is selected automatically. You cannot select **SYNC 1**. During 1X speed dubbing, **SYNC ALL** is selected automatically. If you want to select **SYNC 1**, see the **ADVANCED RECORDING** section of the manual.

TRACK-BY-TRACK DUBBING

Instead of dubbing the entire source disc at once, this mode lets you dub one track at a time. This can be handy for making mixed CDs from several different source CDs.

1. Press **POWER** to turn the unit on.
2. Place the disc to be dubbed in TRAY I, and put a recordable audio CD-R/RW disc in TRAY II.
3. Close both trays.
 - When the blank disc is inserted and TRAY II is Closed, the display will show a **BLANK** message.
4. Press the **AUTO DUB** button.
5. Press the **SPEED** button to select 1X, 2X or 4X dubbing speed.
 - Every time **SPEED** is pressed, the dubbing speed is changed.
6. Select the track you want to record.
7. Press **ENTER**.
8. Finalize the disc after you've finished adding tracks.

To finalize a disc:

1. Load an unfinalized disc in TRAY II.
2. With playback stopped, press and hold in the **FINALIZE** button for three seconds.

PROGRAM PLAYLIST DUBBING

This mode lets you program a playlist for a disc in TRAY I, then dub the tracks-in the order of the playlist-to a disc in TRAY II.

1. Program a playlist.
(For more information, see the PROGRAMMED PLAYLISTS section.)
2. Press **AUTO DUB**.
3. Press **ENTER**.
 - Recording will stop when the playlist has been recorded.
4. Finalize the disc.

To finalize a disc:

1. Load an unfinalized disc in TRAY II.
2. With playback stopped, press and hold in the **FINALIZE** button for three seconds.

RECORDING FROM AN EXTERNAL SOURCE

To record from an ANALOG external source:

1. Connect the source device's analog outputs to the DA-5900's analog inputs.
2. Power ON both units.
3. Place a recordable audio disc (CD-R or CD-RW) label side up in TRAY II.
4. Close TRAY II.
 - When a blank disc is placed in TRAY II, the display will show BLANK.
5. Repeatedly Press **INPUT** until ANALOG appears on the display.
6. Select the desired mode of track division (track number assignment) by pressing the **MANUAL/AUTO** button (see the ADVANCED RECORDING section for more information).
7. Press the player's **EXT. RECORD** or the remote's **RECORD** button to arm recording.
8. Press TRAY II's **PLAY [▶]** button to start recording.
9. Play the source to be recorded.
10. If MANUAL track division was selected, press **ENTER** whenever you want to create a new track. If AUTOMATIC track division was selected, a new track will be created whenever three seconds of silence is received from the source device. (The unit stops recording if there is 20 seconds of silence.)
11. Finalize your newly recorded disc.

To finalize a disc:

1. Load an unfinalized disc in TRAY II.
2. With playback stopped, press and hold in the **FINALIZE** button for three seconds.

To record from a DIGITAL external source:

1. Connect the source device's coaxial digital output to the DA-5900's coaxial digital input. Or connect the source device's optical digital output to the DA-5900's optical digital input.
2. Power ON both units.
3. Place a recordable audio disc (CD-R or CD-RW) label side up in TRAY II.
4. Close TRAY II.
 - When a blank disc is placed in TRAY II, the display will show BLANK.
5. Repeatedly press **INPUT** until OPTICAL or COAXIAL appears on the display. (Select OPTICAL if the source device is connected to the

DA-5900's optical digital input; select COAXIAL if the source device is connected to the DA-5900's coaxial digital input.)

6. Press the **CD SYNC** button to select SYNC 1 track or SYNC ALL tracks (see the ADVANCED RECORDING section for more information).
7. Press the player's **EXT. RECORD** button or the remote's **RECORD** button to arm recording.
8. Press **ENTER** to confirm.
9. Press the source device's **PLAY** button to start recording.
10. Finalize your newly created disc.

To finalize a disc:

1. Load an unfinalized disc in TRAY II.
2. With playback stopped, press and hold in the **FINALIZE** button for three seconds

To stop recording:

- Press the **STOP [■]** button

To temporarily pause recording:

- Press the **PAUSE [⏸]** button.

NOTE: During digital recording, if the input signal stops for 5 seconds, recording will stop.

NOTE: During digital recording from an external source, if the unit detects copy-prohibit signals, SCMS appears on the display, and the unit records the disc in analog mode at 1X speed.

NOTE: Every time recording is paused or stopped, a new track number will be assigned.

Advanced Recording

This section covers advanced recording methods.

When the **MANUAL/AUTO** button is pressed, the track division mode used during recording changes.

- The A-TRACK indicator lights when the automatic track division mode is enabled.
- When the unit is in manual track division mode (A-TRACK indicator not lit), the track number on the disc you're recording is only increased when the **RECORD** button is pressed during recording.
- When the A-TRACK indicator is lit, the track number is increased when three seconds of silence is detected or when **RECORD** is pressed.

ABOUT MANUAL TRACK NUMBERING

It is possible to manually divide the CD-R or CD-RW disc into tracks while recording.

- While recording is taking place, press the **RECORD** button. The current track number will be increased by one.
- Manual track division cannot be used when dubbing a disc from TRAY I to a disc in TRAY II.
- Manual track division can be used when A-TRACK (automatic track division) is OFF or ON.

ABOUT AUTOMATIC TRACK NUMBERING

During dubbing:

A-TRACK (automatic track division) is always ON. When three seconds of silence is detected, the unit will automatically increase to the next track number. You cannot add track numbers manually.

When recording through a digital input from an external source:

- When A-TRACK is ON, and three seconds of silence is detected, the unit will automatically increase to the next track number.
- If the source doesn't contain silence between the tracks, A-TRACK does not work at all.
- If that's the case, add track numbers by pressing the **RECORD** button during recording.

When recording through the analog inputs from an external source:

- If A-TRACK is ON, the unit will automatically increase to the next track number when three seconds of silence is detected.
- If A-TRACK is OFF, the track number will only be increased manually by pressing **RECORD** during recording.
- Even when A-TRACK is ON, you can also add track numbers by pressing the **RECORD** button during recording from an external source.

INCREMENT LEVEL

The increment level setting affects when the DA-5900 will start recording during DIGITAL SYNCHRONIZED mode recording.

AND

When the unit will add a new track number during A-TRACK mode recording.

The settings options are:

- 60 dB
- 50 dB
- 40 dB

(A decibel (dB) is a measure of sound volume.)

The unit defaults to the -60 dB setting.

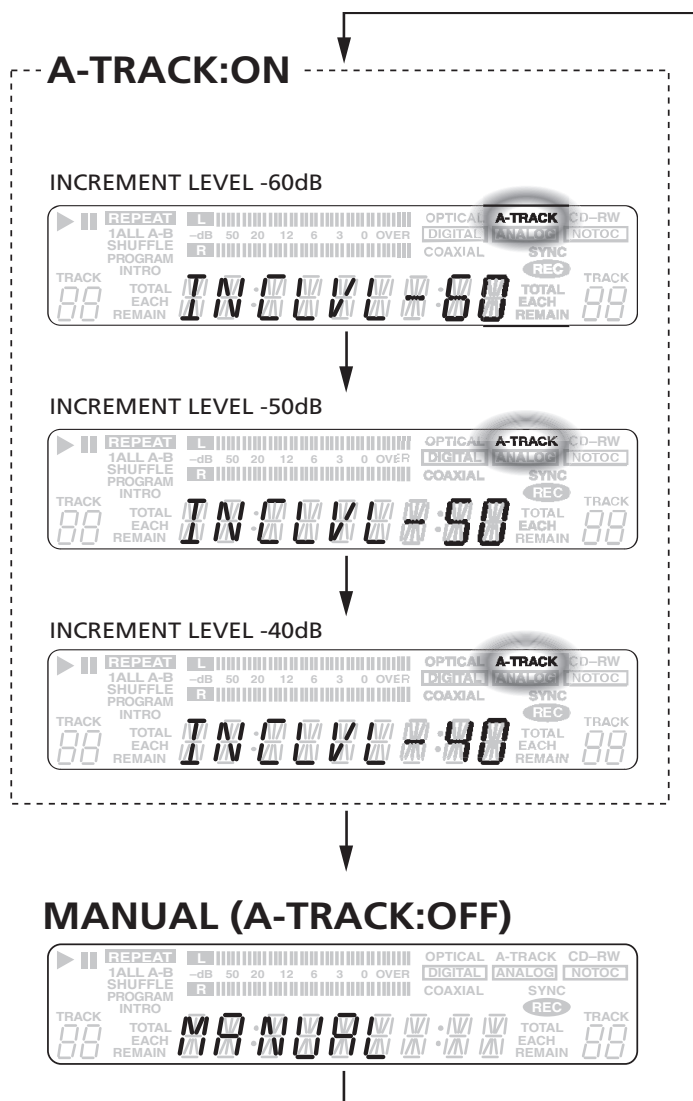

Advanced Recording

A higher setting such as -40 dB means that:

- During digital SYNCHRONIZED mode recording, a relatively loud input signal will be required to trigger the start of recording.
- During A-TRACK mode recording, a fairly silent passage-with some background hiss-will trigger an increase to the next track number on the disc being recorded.

A lower setting such as -60 dB means that:

- During digital SYNCHRONIZED mode recording, a relatively quiet input signal will trigger the start of recording.
- During A-TRACK mode recording, a very silent passage-with little or no background hiss-will be required to trigger an increase to the next track number on the disc being recorded.

ABOUT DIGITAL SYNCHRONIZED RECORDING

In Digital Synchronized Recording mode, recording automatically begins when signal from an external source is received. Recording automatically ends when the signal from an external source ends. Digital synchronized recording is only possible when recording through a digital input from an external source such as a CD player or MiniDisc deck.

Note that the INCREMENT LEVEL setting (discussed in the previous section of this manual) affects how loud an input signal must be in order to trigger recording.

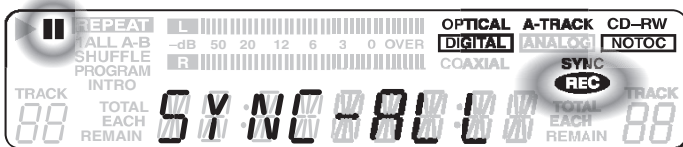
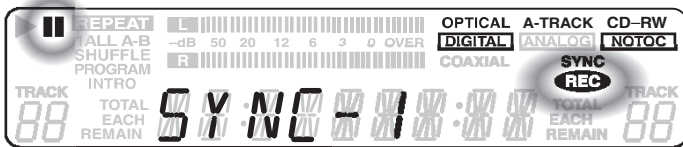

ABOUT RECORDING FROM YOUR TURNTABLE

This section explains how to connect your turntable to the DA-5900 for recording. These guidelines apply ONLY when recording from a turntable into the DA-5900.

Some turntables have a built-in preamplifier. If yours does, connecting will be quite simple as illustrated below:



If your turntable doesn't have a built-in preamplifier (most don't), the turntable can be connected to a separate preamplifier that's connected to the DA-5900's inputs.



Some AV receivers have a built-in phono preamp. If yours does, you can connect as follows:



Finalizing Discs

The last step in making a recording is the finalization process. Unless this step is completed, the disc will not work in other players or the DA-5900's TRAY I. Once finalized, CD-R discs will play in virtually any CD player. CD-RW discs will play in this unit and other CD-RW compatible players. Check the specifications of your CD player if you have questions about compatibility with CD-RW discs.

Once a CD-R disc has been finalized, it cannot be unfinalized. A finalized CD-RW disc can be unfinalized, allowing you to erase or add songs.

Unfinalized CD-R and CD-RW discs can only be played in the DA-5900's TRAY II. Unfinalized discs will not play in the unit's TRAY I.

To finalize a disc:

1. Load an unfinalized disc in TRAY II.
2. With playback stopped, press and hold in the **FINALIZE** button for three seconds.
 - Finalization will take about 60 seconds.
 - If for some reason you wish to cancel the finalize process, press **STOP** [■].
 - When the operation is finished, **COMPLETE** will appear briefly on the display, then the display will return to its track/time display mode.
 - During the finalization process, all buttons are disabled. Never turn the power off or unplug the power cord.

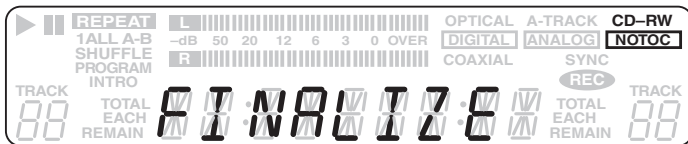

UNFINALIZING AND/OR ERASING A CD-RW

The following information only applies to CD-RW type discs. It does not apply to CD-R discs.

- It is possible to erase the last recorded track. It is also possible to erase a whole disc.
- Erase procedures are possible only on an unfinalized CD-RW disc. If a CD-RW disc has been finalized, it must be unfinalized before it can be erased.

To unfinalize a CD-RW:

1. Load a finalized CD-RW into TRAY II.
2. Press the **FINALIZE** button.

To erase an entire CD-RW:

1. Load a recorded CD-RW into TRAY II.
2. Press and hold in the **ERASE** button for three seconds.
 - If the disc was finalized, it will be automatically unfinalized and erased. If the disc wasn't finalized, it will still be erased.

To erase the last track on a CD-RW:

1. Load a recorded CD-RW into TRAY II.
2. If the disc is finalized, press **ERASE** to unfinalize the disc.
3. Press **ERASE** to erase the last track on the disc.
4. Repeat step 3 until as many tracks as desired have been erased.

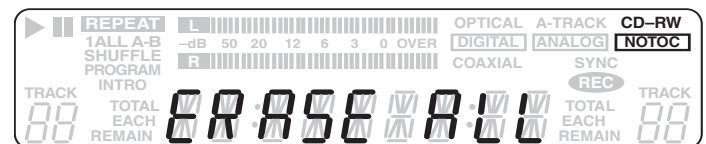

Erase all the tracks.

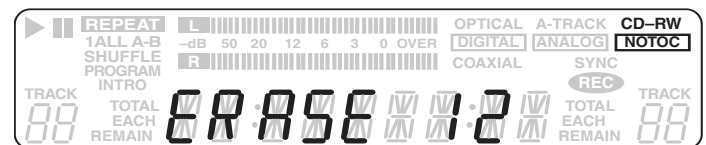

Erase the last track. In this example, track 12 is the disc's last track.

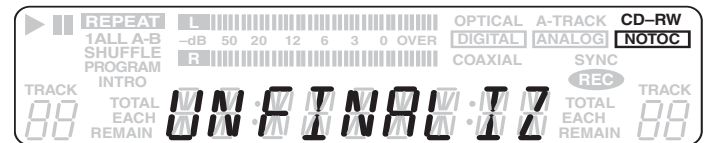

Unfinalize the disc.

Time Displays

Press the **TIME** button on the remote control to switch the displayed mode of time. Each instance the **TIME** button is pressed, the mode changes as follows:

IN THE PLAY/PAUSE MODE:

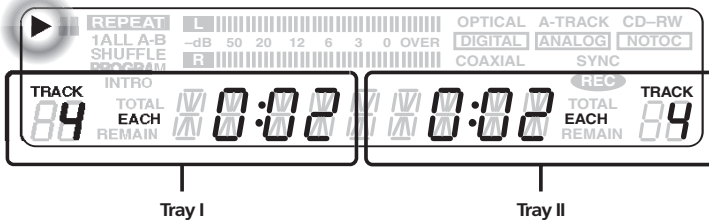

1. Elapsed time of the current track being played.

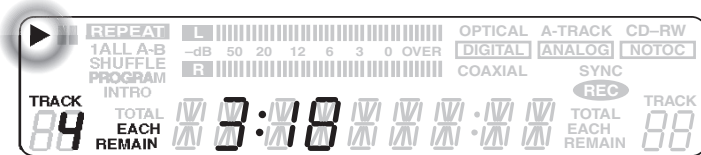

2. Remaining time of the current track being played.

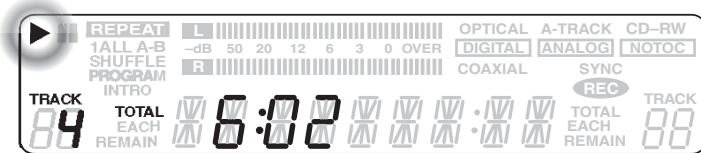

3. Elapsed play time of all tracks.

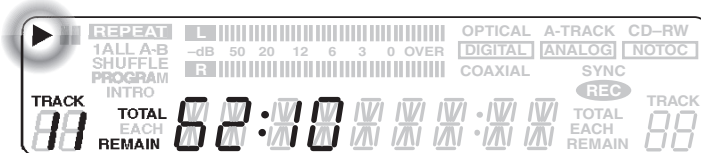

4. Remaining play time of all tracks.

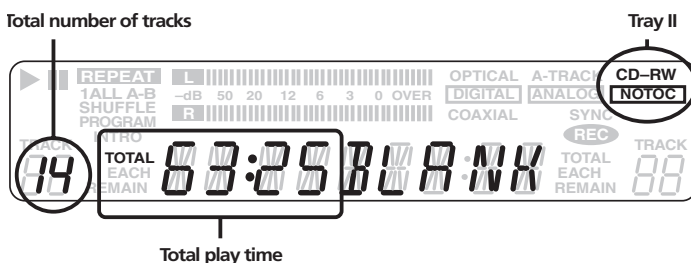

5. The total play time and the number of tracks.

IN THE STOP MODE:

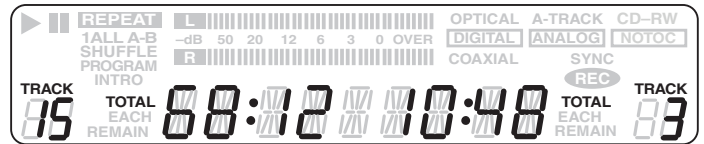

1. The total play time and the number of tracks.

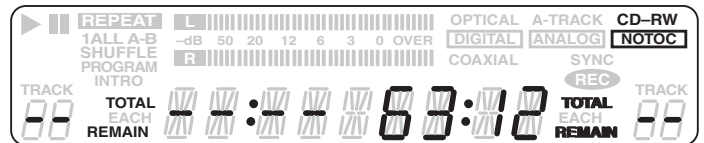

2. Remaining recording time on the disc.

IN RECORDING MODE:

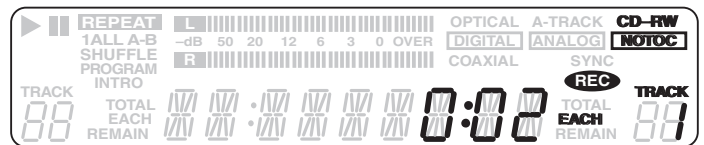

1. Elapsed recording time of the current track.



2. Remaining recording time on the disc.

Player Display Messages

The following are the various messages that the DA-5900 will display during operation.

ANALOG: Lights when a coaxial or optical connection is made; lights when a analog copy is being made.

BLANK: A blank CD-R/RW disc is loaded in the tray.

CLOSE: Close the disc tray.

COMPLETE: Dubbing, recording, finalizing or erasing has been completed.

DIGITAL: Lights when a coaxial or optical connection is made; lights when a digital copy is being made.

DUBB 1X: Normal speed dubbing from TRAY I to II.

DUBB 2X: 2X speed dubbing from TRAY I to II.

DUBB 4X: 4X speed dubbing from TRAY I to II.

ERASE **: Erase the last track of the CD-RW disc.

ERASE ALL: Erase all the tracks of the CD-RW disc.

FINALIZE: Finalize the disc.

INCLVL **: Increment level.

MANUAL: Auto track division is off.

NO DISC: No disc is loaded in the tray.

NO TOC: Lights when a disc without a table of contents is loaded.

OPEN: Open the tray.

PMA WRITE: Write programmed material on the disc.

READING: The unit is reading the disc.

REC **DB:D2: Recording level

STEP **: Program number

SYNC-1: Record one track using synchronized recording.

SYNC-ALL: Record all the tracks using synchronized recording.

UNFINALIZ: Unfinalize the CD-RW disc.

(** represents a variable. will be shown as actual number.)

ERROR MESSAGES: When an error message is displayed, press the STOP button and try to determine its cause.

Error Message	Cause	What To Do
CAN'T REC- Cannot record, erase or finalize the disc	<ol style="list-style-type: none"> 1. The disc is full. 2. CD-RW is finalized. 3. CD-R is finalized. 4. CD-R discs cannot be erased. 	<ol style="list-style-type: none"> 1. Change the disc. 2. If the CD-RW disc is finalized, unfinalize the disc. 3. Make sure that you are using Audio CD-RW or CD-R discs for audio recording. Do not use Data discs.
D-UNLOCK- Digital input is selected, but you cannot record.	<ol style="list-style-type: none"> 1. A digital source is not connected. 2. The source unit's power is off. 	<ol style="list-style-type: none"> 1. Connect an external unit using digital connections (coaxial, optical). 2. Turn the external unit's power ON.
DISC FULL	<ol style="list-style-type: none"> 1. There is no space on the disc. 2. No tracks are available on the disc. 	<ol style="list-style-type: none"> 1. Insert a new blank disc. 2. Erase unwanted tracks (CD-RW only), then record new tracks. 3. A maximum of 99 tracks can be recorded per disc.
NOCD-DA:D2- DATA Discs designed for computer systems cannot be used for audio recording on the DA-5700.	<ol style="list-style-type: none"> 1. A Data disc is being used. 	<ol style="list-style-type: none"> 1. Use discs bearing the "DIGITAL AUDIO" logo.
NO SPACE:D2	<ol style="list-style-type: none"> 1. The CD-R/RW disc placed in TRAY II does not have enough space to dub the entire disc in TRAY I. 	<ol style="list-style-type: none"> 1. Use a CD-R/RW of a larger capacity. 80-minute discs are largest.
PGM FULL	<ol style="list-style-type: none"> 1. 32 tracks have been programmed. 	<ol style="list-style-type: none"> 1. You can only program a total of 32 tracks. 2. Clear the program, then program 32 new tracks.
COPY	<ol style="list-style-type: none"> 1. You are trying to digitally record a "second-generation" digital copy. 	<ol style="list-style-type: none"> 1. Due to SCMS restrictions, you may only make 1st generation digital copies. In other words, you cannot copy a copied CD. If you would like to make more backups of a copied disc, you can do so in analog mode.

Troubleshooting

If you are having problems with the DA-5900, please take the time to read this section before contacting your dealer or TDK Technical Services.

No power.

Check the connection to the AC power supply.

The CD-R or CD-RW I recorded only plays in TRAY II.

You didn't finalize the disc. Only finalized discs can be played in TRAY I and other CD players.

The CD-RW I recorded doesn't play in my other CD player.

Your other CD player may not be compatible with CD-RW discs. Try using a CD-R instead.

Can't dub an entire disc faster than 1x.

If the source disc is a commercial music CD, or has been copied digitally, the display may show an SCMS message when high-speed dubbing is attempted. If you see this message, due to SCMS restrictions, you can only dub at 1X speed. SCMS might be detected for each track on the audio disc.

I can't record my turntable through the DA-5900's inputs.

The signal from your turntable must be passed through a phono preamplifier before it is routed into the DA-5900. (Unless your turntable has a built-in preamplifier, it cannot be connected directly to the DA-5900.)

Here's how you must connect if your turntable doesn't have a built-in preamplifier:

Some turntables have a built-in preamplifier.

If yours does, connecting will be quite simple as illustrated below:



If your turntable doesn't have a built-in preamplifier (most don't), the turntable can be connected to a separate preamplifier that's connected to the DA-5900's inputs.



Some AV receivers have a built-in phono preamp. If yours does, you can connect as follows:



No sound from speakers.

- Check the connection to the stereo system.
- Make sure a disc has been inserted.

The sound is noisy or distorted.

The unit is too close to a TV set or similar appliance. Move the unit away from appliances, or turn appliances off.

Remote control doesn't work.

- Make sure you have fresh batteries.
- The remote control has a range of 5m./15ft. Point remote control at the front panel of the DA-5900.
- Clear any obstacle between the remote control and the DA-5900.
- Interference from fluorescent lights can cause the DA-5900 to function improperly. Turn fluorescent lights off.
- Other appliances near the unit or remote control that use infrared light may interfere with operation of the DA-5900.

Cannot play audio.

- Insert disc with label side up.
- If the disc is dirty, clean the surface of the disc.
- A blank disc has been inserted. Insert a disc that has music on it.

Sound skips.

- Place the unit on a stable surface to avoid vibration and shock.
- If the disc is dirty, clean the surface of the disc.
- Don't use scratched, damaged or warped discs.

Recording is not possible.

- A commercial music CD or finalized disc has been inserted into the unit. Use a recordable (Audio CD-R) or rewritable (Audio CD-RW) audio disc.
- A digital copy cannot be made of a copied disc due to SCMS restrictions. Please use analog mode to make additional copies of a copied disc.
- The disc does not have any more free space. Use another disc.
- The recording level is too low. Adjust the incoming recording level on the DA-5900.
- Check that all external components are properly connected.

NOTE: Some new commercial audio CDs are copy protected. This may prevent making digital copies of the discs.

If normal operation freezes or the unit cannot function normally, push the power switch OFF, unplug the power cord from the outlet, then plug it in again. Push the power switch back ON.

Beware of condensation

When the unit is moved in from a cold place, or used after a sudden temperature change, there is a danger of condensation; vapor in the air could condense on the internal mechanism, making normal operation impossible. To prevent this, or if this occurs, leave the unit on for one to two hours. The unit should eventually stabilize at the temperature of its surroundings.

TDK Warranty

ONE YEAR LIMITED WARRANTY.

TDK Electronics Corporation ("TDK") warrants to the end-user customer that this digital audio CD recorder will be free from defects in material and workmanship for a period of one (1) year from date of purchase. If TDK receives notice of any such defects during the warranty period, TDK will, at its option, either repair or replace the Product it finds to be defective at no charge (except for shipping and insurance). Repair of defective Product may be with either new or rebuilt replacement parts that will be warranted for the remainder of the original warranty period. Any exchanged parts under this warranty will become the property of TDK. Replacement Product may be either new or reconditioned. If the Product is discontinued and no longer available, then it may be replaced with Product determined by TDK to be of similar value and performance. TDK does not warrant that the operation of the Product will be uninterrupted or error free. This Limited Warranty does not apply to defects resulting from (1) acts of God, accident, misuse, abuse, negligence, abnormal, or unusually heavy use; (2) improper installation, operation, testing or maintenance; (3) power failure or connection to improper voltage supply; or (4) attempted repair by any party other than TDK. This Limited Warranty does not apply when the malfunction results from the use of the Product in conjunction with other products, software or accessories, or where it is determined by TDK that there is no fault with the Product itself. This Limited Warranty is invalid if the factory-applied serial number has been altered or removed from the Product. This Limited Warranty extends only to the original end-user customer and is not transferable to any subsequent purchaser. This Limited Warranty is valid only within the United States. For areas outside the United States, contact the authorized dealer from whom you purchased the Product to determine what warranty, if any, applies. In order to obtain warranty service, you must deliver the Product to TDK freight prepaid, in either its original package or packaging providing a degree of protection equivalent to that of the original packaging, along with proof of purchase. (Please contact TDK at the number listed below or in the manual for further information.) TDK MAKES NO OTHER WARRANTIES, EXPRESS OR IMPLIED, INCLUDING BUT NOT LIMITED TO THE WARRANTIES OF MERCHANTABILITY OR FITNESS FOR A PARTICULAR PURPOSE. TO THE EXTENT THAT ANY IMPLIED WARRANTIES APPLY, DESPITE THEIR EXCLUSION UNDER THIS LIMITED WARRANTY, SUCH WARRANTIES SHALL BE LIMITED TO THE DURATION OF THE EXPRESS WARRANTIES PROVIDED HEREUNDER. THE REMEDIES PROVIDED UNDER THIS LIMITED WARRANTY ARE THE SOLE AND EXCLUSIVE REMEDIES. TDK'S LIABILITY UNDER ANY LEGAL THEORY FOR ANY LOSS OR DAMAGE IN ANY WAY RELATED TO THE PRODUCT SHALL IN NO EVENT EXCEED THE PURCHASE PRICE OF THE PRODUCT. IN NO EVENT SHALL TDK BE LIABLE FOR ANY INCIDENTAL OR CONSEQUENTIAL DAMAGES RESULTING FROM THE USE OF THE PRODUCT. Some states do not allow limitations on how long an implied warranty lasts or any exclusion or limitation of incidental or consequential damages, so the above limitations or exclusions may not apply to you. This warranty gives you specific legal rights, and you may have other rights that vary from state to state.

U.S.A.:

TDK Electronics Corporation
901 Franklin Avenue
Garden City, NY 11530, U.S.A.

For On-line support or to contact Technical support, please visit:

<http://www.tdk.com/support>

For registration of product, please visit:

<http://www.tdk.com/registration>

Canada:

AVS Technologies Inc.
2100 Trans Canada Highway South
Montreal, Quebec H9P 2N4, Canada

Mexico:

Electronics & Digitals de Mexico, S.A.
Cerro de San Miguel No. 148
Col. Rincon del Valle Tlalnepantla, EDO Mexico
Phone number - 53 66 0004

Sign up for the Customer Appreciation Newsletter at www.tdk.com, The Digital Sweetspot™.

FRENCH COVER