

# Heyinovo

---

## **Hot Biopsy Forceps User Manual**

**Technical Publications**

**Document No: WR-RD-13-DG02, Rev. D**



Copyright By Wilson Instruments (SHA) Co., Ltd.

## ***Regulatory Requirement***

This product complies with regulatory requirements of the following European Directive 93/42/EEC concerning medical devices.



## ***Revision History***

| REV    | DATE        | Complied by        | Approved by    |
|--------|-------------|--------------------|----------------|
| Rev. A | Apr-02-2007 | Mr. Yao dong, Wang | Mr. Xin, Huang |
| Rev. B | Jun-18-2009 | Mr. Yao dong, Wang | Mr. Xin, Huang |
| Rev. C | Oct-08-2013 | Ms. Xiaoping, Qian | Mr. Xin, Huang |
| Rev. D | Nov-28-2013 | Ms. Xiaoping, Qian | Mr. Xin, Huang |

**Wilson Instruments (SHA) Co., Ltd.  
25D, He Yi Business Plaza, No. 420,  
Jiang Ning Rd., Shanghai 200041,  
P.R.China**

---

## **Certifications**

- General Electric Medical Systems is ISO 9001 and ISO 13485 certified.

## **Original Documentation**

- The original document was written in English.

## **Attention**

This manual contains necessary and sufficient information to operate the system safely. Advanced equipment training may be provided by a factory trained Applications Specialist for the agreed-upon time period.

Read and understand all instructions in this manual before attempting to use the Hot Biopsy Forceps.

Keep this manual with the equipment at all times for ready use. Periodically review the procedures for operation and safety precautions.

If any queries about the content of this manual, feel free to contact us.

## **Conformance Standards**

International Electrotechnical Commission (IEC).

- IEC/EN 60601-1 Medical Electrical Equipment, Part 1 General Requirements for Safety
- Medical electrical equipment -Part 2-2: Particular requirements for the safety of high frequency surgical equipment

# Table of Contents

|   |         |
|---|---------|
| Regulatory Requirement - - - - -                                    | Page 2  |
| Revision History- - - - -   | Page 2  |
| Certification- - - - -  | Page 3  |
| Original Documentation- - - - -                                     | Page 3  |
| Attention - - - - -   | Page 3  |
| Conformance Standards - - - - -                                     | Page 3  |
| <b>Chapter 0 —Notice upon Use of Product</b>                        |         |
| Product Description - - - - -                                       | Page 5  |
| User Qualification - - - - -  | Page 6  |
| Accessories - - - - -   | Page 6  |
| Repair and Modification - - - - -                                   | Page 6  |
| Marking and labels - - - - -  | Page 6  |
| Important Notes - - - - -   | Page 7  |
| <b>Chapter 1 —Checking Items in the package</b>                     | Page 8  |
| <b>Chapter 2 —Name, Function, and Specifications of the Product</b> | Page 9  |
| Component Name and Function - - - - -                               | Page 9  |
| Model and specification - - - - -                                   | Page 9  |
| Classification- - - - -   | Page 10 |
| Operating environment - - - - -                                     | Page 10 |
| <b>Chapter 3 —Preparation, Inspection and Operation</b>             | Page 11 |
| Preparation - - - - -   | Page 11 |
| Inspection - - - - -  | Page 12 |
| Operation - - - - -   | Page 15 |
| <b>Chapter 4 —Cleaning, Disinfection, and Sterilization</b>         | Page 19 |
| General - - - - -   | Page 19 |
| Apparatus for cleaning, disinfection, and sterilization - - - - -   | Page 20 |
| Cleaning - - - - -  | Page 21 |
| Lubrication - - - - -   | Page 21 |
| Assembly - - - - -  | Page 21 |
| Sterilization - - - - -   | Page 21 |
| <b>Chapter 5 —Storage</b>   | Page 22 |
| Inspection before Storage- - - - -                                  | Page 22 |
| Storage - - - - -   | Page 22 |
| <b>Chapter 6 —Disposal of waste</b>                                 | Page 23 |
| <b>Chapter 7 —Service Information</b>                               | Page 23 |

# Chapter 0

## Notice upon Use of Product

### 0.1 Product Description

The hot biopsy forceps are used for cutting and coagulation in the alimentary canal. They are used together with various types of endoscopes, connected to high frequency surgical generator, transfer heat to conduct cutting or coagulation operation on polyp tissue. The obtained tissue can be used for biopsy. Please do not use them for other purposes.

### 0.2 User Qualification

The qualified operator of the equipment should be a physician or medical professional staff under the supervision of the physician. The operator must have received sufficient training on clinical endoscope technology. Therefore, the manual will not explain or discuss any clinic endoscope technology.

### 0.3 Accessories

Make sure the equipment is compatible with the apparatus in use. The use of apparatus that is incompatible with the equipment may lead to the injury of the patient or damage of the equipment. The equipment is compatible with OLYMPUS high frequency electrosurgery apparatus (PSD-10, UES-10, PSD-20, UES-20) and WILSON HF surgical equipment (UES-30).

Recommended electrosurgery apparatus devices output frequency: 400KHZ.

### 0.4 Repair and Modification







All the components of the equipment should not be repaired by the user.











Please do not disassemble, refit or repair the equipment, or it may lead to the injury of the patient or the operator and the damage of the equipment.

For the loss incurred by the above practice, our company will not take any responsibility.

### 0.5 Marking and labels

**Table 2, Marking and labels**

|   |  |
|---|--|
|  | CE Mark: Indicates that the device conforms to Council Directive 93/42/EEC concerning medical devices. |
|  | Temperature limitation   |
|  | Keep away from sunlight  |
|  | Keep dry   |
|  | Consult instructions for use   |
|  | Do not resterilize   |

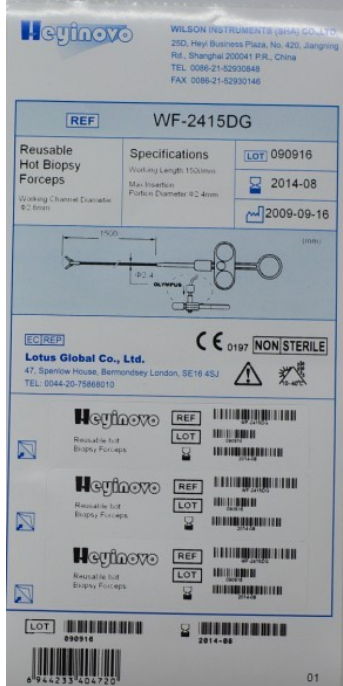
|   |  |
|---|--|
|    | Do not use if package is damaged   |
|    | Manufacturer   |
|    | Do not reuse   |
|    | Date of manufacture  |
|    | Used by  |
|    | Authorized Representative of European community'   |
|    | Sterilization using ethylene oxide   |
|    | Batch code   |
|    | Symbol for Attention, consult accompanying documents   |
|   | Symbol for 'Type BF applied part'  |
|  | Symbol for 'Environment Protection-Waste electrical products should be disposed of with household waste. Please recycle where facilities exist. Check with your local Authority or retailer for recycling advice.' |
|  | Product marking  |

## 0.6 Important Notes

Before using the product, please read carefully this instruction to fully understand all warnings, cautions and attentions incorporated herein:

- 1), In order to avoid incompatibility and unsafe operation, please use suitable cables, accessories, active and neutral electrodes and HF surgical equipment set with suitable maximum allowed h.f peak voltage;
- 2) The entire area of the neutral electrode should be reliably attached to the patient's body and as close to the operating field as possible;
- 3) The patient should not come into contact with metal parts which are earthed or which have an appreciable capacitance to earth (for example operating table supports, etc.). The use of antistatic sheeting is recommended for this purpose;
- 4) Skin-to-skin contact (for example between the arms and body of the patient) should be avoided, for example by insertion of dry gauze;
- 5) When HF surgical equipment and physiological monitoring equipment are used simultaneously on the same patient, any monitoring electrodes should be placed as far as possible from the surgical electrodes. Needle monitoring electrodes are not recommended. In all cases, monitoring systems incorporating high frequency current-limiting devices are recommended.
- 6) The cables to the surgical electrodes should be positioned in such a way that contact with the patient or other leads is avoided. Temporarily unused active electrodes should be stored so that they are isolated from the patient.
- 7) For surgical procedures where the h.f. current could flow through parts of the body having a relatively small cross-sectional area, the use of bipolar techniques may be desirable in order to avoid unwanted coagulation;
- 8) The output power selected should be as low as possible for the intended purpose;
- 9) Apparent low output or failure of the HF surgical equipment to function correctly at the normal operating settings may indicate faulty application of the neutral electrode or poor contact in its connections. In this case, the application of the neutral electrode and its connections should be checked before selecting a higher output power.
- 10) The use of flammable anaesthetics or oxidizing gases such as nitrous oxide (N<sub>2</sub>O) and oxygen should be avoided if a surgical procedure is carried out in the region of the thorax or the head, unless these agents are sucked away. Non-flammable agents should be used for cleaning and disinfection wherever possible. Flammable agents used for cleaning or disinfecting, or as solvents of adhesives, should be allowed to evaporate before the application of h.f. surgery. There is a risk of pooling of flammable solutions under the patient or in body depressions such as the umbilicus, and in body cavities such as the vagina. Any fluid pooled in these areas should be mopped up before HF surgical equipment is used. Attention should be called to the danger of ignition of endogenous gases. Some materials, for example cotton, wool and gauze, when saturated with oxygen may be ignited by sparks produced in normal use of the HF surgical equipment;
- 11) For patients with cardiac pacemakers or other active implants, a possible hazard exists because interference with the action of the pacemaker may occur, or the pacemaker may be damaged. In case of doubt, approved qualified advice should be obtained.
- 12) Interference produced by the operation of h.f surgical equipment may adversely influence the

operation of other electronic equipment;

13) Regularly to inspect the accessories. In particular, electrode cables and endoscopic used accessories should be checked for possible damage to the insulation.

14) This electrodes used with H.F surgical generator can radiate radio frequency energy. The equipment may cause radio frequency interference to other medical and non-medical devices and radio communications. Please provide reasonable protection against such interference.

# Chapter 1

## Checking Items in the package

Check the items in the package according to the table below and whether any of the items damaged. If any questions on the damage or missing of the items, please contact WISLON in time.

The product (repeatable packing) does not undergo sterilization process before delivery. Please clean, disinfect, and sterilize the product before initial use and then assemble the equipment according to the user manual.

The product (disposable packing) has undergone sterilization process. Use it after unpacking, and no refit needed. Before unpacking, make sure the package is not damaged, or else the equipment should not be used.

**Table 3, Repeatable Electrode Packing List**

| External sheath | Internal sheath | Handle | User manual | Remark |
|-----------------|-----------------|--------|-------------|--------|
| 1               | 1               | 1      | 1           | ----   |



# Chapter 2

## Name, Function, and Specifications of the Product

### 2.1 Component Name and Function

#### 1) Main unit:

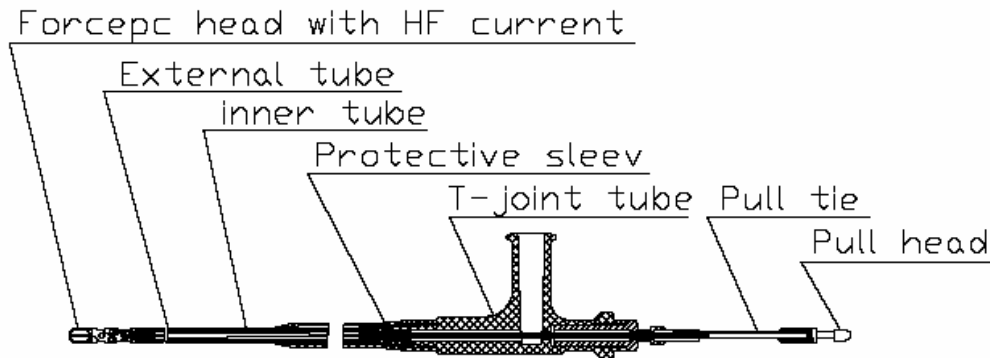

**Fig 4 Component diagram (DG)**

#### 2) General use handle

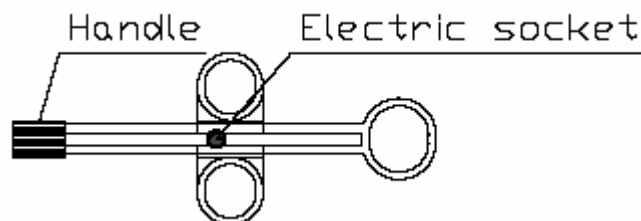

**Fig 7 General use handle diagram**

### 2.2 Model and specification

The table below lists all of our company's electrode products. In addition, we will continuously extend our product range. Please contact our company for detailed information,

#### CAUTION

The internal sheath, external sheath, and handle of the electrode can only be used together with the apparatus suggested by WILSON, or else the patient or operator may be injured, and the function of the equipment may be abnormal or damaged.

#### CAUTION

Please do not use the equipment when the voltage exceeds the rated voltage listed below, or else the patient, operator, or assistant may be injured, such as burned, and the endoscope and equipment may be damaged.

**The product type and specification description:**

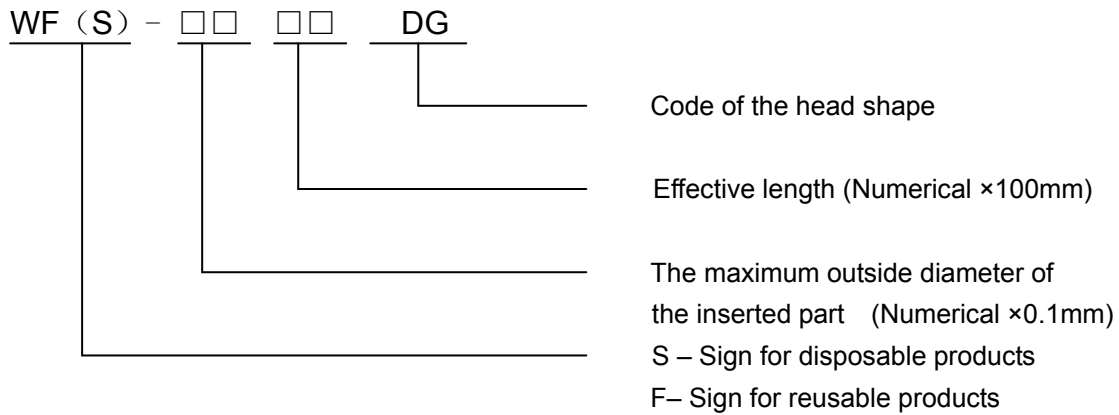

**Table 4. Model list**

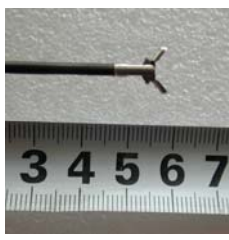
| Electrode head shape | Figure   | Model  | Weight (g) | Max diameter of the inserted part (mm) | Effective length(mm) | Rated voltage  |
|----------------------|--|--------|------------|--|----------------------|--|
| Forceps electrode    |  | 1807DG | 40         | 1.8                                    | 700                  | Cutting mode:<br>1600Vp,<br>3200Vp-p<br>Coagulation mode:<br>2900Vp,<br>5800Vp-p |
|                      |  | 1810DG | 43         |  | 1000                 |  |
|                      |  | 1815DG | 49         |  | 1500                 |  |
|                      |  | 2415DG | 54         | 2.4                                    | 1500                 |  |
|                      |  | 2417DG | 58         |  | 1700                 |  |
|                      |  | 2421DG | 64         |  | 2100                 |  |
|                      |  | 2423DG | 66         |  | 2300                 |  |

Note: 1), 18 Series is fit for the endoscopes whose forceps aperture diameter  $\geq 2.0$  mm;  
 2), 24 Series is fit for the endoscopes whose forceps aperture diameter  $\geq 2.8$  mm.

**2.3 Classification:**

**MDD 93/42/EEC classification:** Class II b

**Model of operation:** Continuous Operation

**Degree of protection against electric shock:** Type BF Applied part

**Electric shock protection grade:** The electric shock protection grade of the product depends on the connected high frequency electrosurgery (generator) apparatus. Please refer to the user manual of the high frequency apparatus.

**2.4 Operating environment:**

**Ambient temperature:** 10-40°C (50-104°F)

**Relative humidity:** 30-85%

**Atmospheric pressure:** 700 to 1060hPa(0.7 to 1.1kgf/cm<sup>2</sup>) (10.2 to15.4 psia)

**Rating voltage:** 1600Vp (3200Vp-p) for cutting mode  
 2900Vp (5800Vp-p) for electrode coagulation mode

# Chapter 3

## Preparation, Inspection and Operation



Please do not use the equipment on the patients who have implanted pacemaker. Or the interference of the high frequency signals and spark discharge may lead to ventricular fibrillation or the damage of the pacemaker's electronic components, and finally incur lethal injury.

CAUTION

Follow below instructions to prepare and check the equipment before use.

CAUTION

The damage of apparatus or equipment or the deviation of their function may endanger the safety of the patient or the operator, leading to perforation, bleeding, mucosal lesion, and tissue causalgia or burning, and the severe damage of the apparatus or equipment.

CAUTION

The equipment (repeatability) does not undergo sterilization process before delivery. Please clean, disinfect, and sterilize it before use.

CAUTION

Please do not use the equipment that has not been cleaned and sterilized, or it may lead to infection and tissue rankling.

CAUTION

Do not coil the Insertion Portion with a diameter of less than 15 cm, or the inserted part may be damaged.

CAUTION

Do not use the equipment with excessive force, or it may be damaged.

### 3.1 Preparation

#### Apparatus and personal protection tools

Prepare all the tools used together with the equipment according to respective manual. Proper personal protection tools include safety goggles, mask, water-proof clothing, chemical protective gloves, and etc.

#### Apparatus backup

Backup apparatus should be prepared.

#### Devices for cleaning, disinfecting and sterilizing

Prepare utensils for cleaning, disinfecting and sterilizing so that the equipment can be cleaned in time after use.

## 3.2 Inspection

Wear personal protection tools according to the regulations. Follow below steps to check the equipment before use. If there is anything abnormal, please change to backup apparatus. Meanwhile, have a thorough check on the backup apparatus before use.

### 3.2.1 Sterile packaging inspection (Disposable product)

Check if the sterile packaging is broken, loose or wet. If there is anything abnormal, the sterile packaging has been damaged, so it should be changed by backup apparatus.

### 3.2.2 Appearance inspection

If anything abnormal is detected when you follow below steps, please do not use the equipment. Use the backup apparatus instead.

#### Sheath inspection

Please make sure the front sheath of the inserted part does not have sharp protuberance, pointed edge, or other damages;

- 1), Touch the surface of the inserted part with your fingers, make sure it is not smashed, over bending or has other damages;
- 2), Make sure the joint of the core has not dropped or become loose;
- 3), Check the general handle;
- 4), Make sure the handle has not any cracks.

#### Handle inspection

Please check there is no crack on the handle

CAUTION

That before each use ,the outer surface of the portions of th endoscope and any ehdoscopically -used accessories which are intended to be inserted into a patient should be checked to ensure there are no unintended rough surfaces, sharp edges or protrusion which may cause a safety hazard.

### 3.2.3 Connection and check the joint

CAUTION

Do not connect any equipment or check any joint when the HF surgical equipment is turned on, or the operator or his assistant may be burnt.

CAUTION

Do not pluck the cable when you pull out the joint cable, or the cable or the joint of the apparatus may be damaged.



Advice concerning selection of a monitoring NE with respect to compatibility with the operator's available contact quality monitor.

If anything abnormal is detected when you follow below steps, please do not use the equipment. Use the backup apparatus instead.

**1). Connect the handle to the electric forceps and check the connection.**

1. Circumvolve the retaining ring of the general handle until the blue mark appears (see fig. 3.1)
2. Move the sliding handle to the retaining ring (see fig. 3.1)

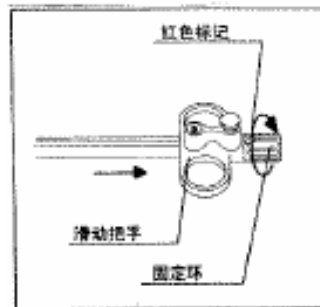

**Fig 3.1**

3. Press the button on the sliding handle; insert the core joint of the electrode into the retaining ring (see fig 3.2)

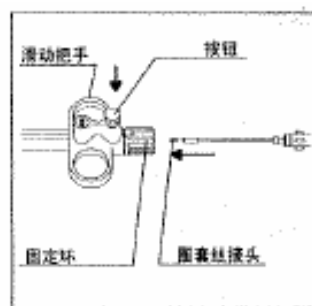

**Fig 3.2**

4. Loosen the button until the internal sheath joint can no longer be inserted in.
5. Push and pull the sliding handle, make sure the core joint is firmly connected.
6. Adjust the four protuberances at the end of the sheath to the four grooves within the retaining ring, and then insert the lock into the retaining ring. (See fig. 3.3)

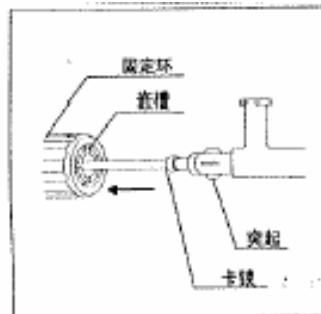

**Fig 3.3**

7. When the lock can not insert any longer, circumvolve the retaining ring for 180 degrees (See fig.3.4)

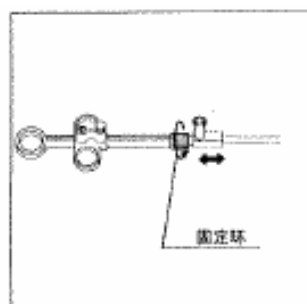
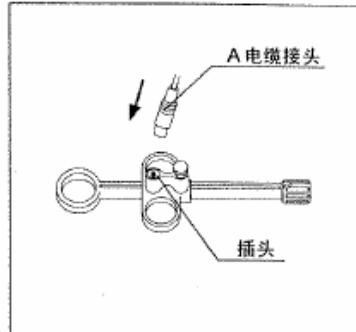

**Fig 3.4**

8. Check the joints between the handle and the core, and the core and the sheath. Make sure the retaining ring and the lock are firmly connected (See fig.3.4)

**2). Connect the general handle to the electric forceps and check the connection.**

1. Insert cable connector A into the plug until you hear the snap sound (see fig. 3.5);



**Fig3.5**

2. Make sure cable connector A is firmly connected;

3. Pull out cable connector A.

**3) Check the operation**

If anything abnormal is detected when you follow below steps, please do not use the equipment and use the backup apparatus instead.

Pull the sliding handle. Make sure the front part of the ring can be taken into the sheath tube.

**4) Check the forceps electrode DG(see fig. 3.6);**

1. Hold the equipment and the general handle, form the inserted part into a 20cm-diameter ring.
2. Slide the sliding handle to and fro, and make sure the forceps can fold and unfold flexibly.
3. The angle of the forceps should be no less than 90 degrees when it is open, and the forceps should be insulated when they are closed.

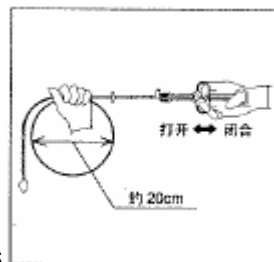

**Fig 3.6**

**3.2.4 Inspecting the System**

Please check the connection of device and handle cable as instructed in the electrosurgery apparatus unit instruction manual. If there were any unusual ,please do not use the equipment in question. If there were any question on electrosurgery apparatus, please refer to the instructions on checking the contents of the steps.

**3.3 Operation**

The qualified operator of the equipment should be a physician or medical workers under the supervision of the physician. The operator must have received sufficient training on clinical endoscopic technology. Therefore, the manual does not explain or discuss any clinic endoscopic technology, but only introduces the basic operation and notices of the equipment.

**CAUTION**

We should be equipped with proper personal protection tools while using the equipment, or the patient's blood, grume, and other potential infective substances may lead to infection. Appropriate personal protection tools include safety goggles, mask, water-proof clothing, and chemical protective gloves.

**CAUTION**

Only when the eyeshot of the endoscope is crystal clear can the electrode product be inserted into the endoscope. If the front of the inserted part cannot be seen in the endoscope's eyeshot, please do not use the equipment, or it may lead to perforation, bleeding, mucosal lesion of the patient, and the severe damage of the apparatus or equipment.

**CAUTION**

When the front of the inserted part protrudes from the front of the endoscope, please do not swerve in the endoscope's curvy part or operate the elevator. Or else the patient may perforate, bleed, or have mucosal lesion.

**CAUTION**

Do not poke the patient's celom tissue with the front of the inserted part, or it may lead to perforation, bleeding, or mucosal lesion of the patient.

**CAUTION**

Do not use other accessories when the equipment is used together with a big double-channel endoscope. Or else the patient, the operator or his assistant may be burnt

**3.3.1 Connect the electrode plate**

Connect the electrode plate to the patient.

**3.3.2 Insert the endoscope****CAUTION**

Please do not insert the electrode into the endoscope when it has not been taken back to the sheath completely (closed), or the front of the inserted part may protrude suddenly from the front of the endoscope. This may lead to perforation, bleeding, or mucosal lesion of the patient, and probably the damage of the endoscope or electrode.

Hold the sliding handle firmly when insert the electrode into the endoscope or the electrode may throw open and extrude from the endoscope all of a sudden, which may lead to perforation, bleeding, or mucosal lesion of the patient, and probably the damage of the endoscope or electrode.

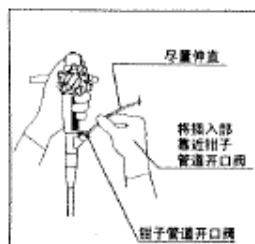
**Fig 3.7**

## CAUTION

Do not insert the electrode by force when it meets great resistance. Instead, the angle of the endoscope should be monitored or the elevator should be lowered until the electrode can smoothly pass through. Inserting by force may damage the endoscope or the electrode, and lead to perforation, bleeding, or mucosal lesion of the patient as well.

## CAUTION

Please do not abruptly push or pull the electrode, or it may lead to perforation, bleeding, or mucosal lesion of the patient, and the damage of the endoscope or electrode.

## CAUTION

Keep the inserted part close to the open-ended valve of the forceps channel and try to keep it straight when insert the electrode into the endoscope, or the inserted part may be damaged, hitch or touch tissue



Do not throw open the sliding handle, or the sudden extrusion of the electrode may lead to perforation, bleeding, or mucosal lesion of the patient.



Do not use excessive force when you hitch, forceps or touch the tissue, or the patient may bleed or have mucosal lesion.

## CAUTION

The ring electrodes in WILSON include that can be circumvented and those cannot. Please pay attention to the type when use it. The equipment may be damaged if circumvented by force.

- 1), Pull the sliding handle and open the electrode.
- 2), Adjust the inserted angle according to demand, push the electrode to the disease part.
- 3), Use the electrode product to cut or coagulation the target tissue.

### 3.3.3 Cutting or coagulation

Absorb the liquid sticking to the electrode and celom tissue. If electrosurgical is conducted with the liquid sticking to, the patient may perforate, bleed, mucosal lesion or tissue burnt.

When use the high frequency apparatus of the endoscope, try your best to take the minimum output value and the shortest time required by the operation. Excessive output will lead to perforation, bleeding, or mucosal lesion of the patient.

Do not knot cable A or tie it together with other cables for medical equipment, or the high frequency signals and the interference of the spark discharge during the electrosurgery may cause the function of other medical equipment abnormal and incur bad consequences to the patient. It may also make the output of the electrosurgery equipment abnormal and lead to perforation, bleeding and mucosal lesion of the patient.



While operating, make sure the electrode is electrified. Operating without electricity may cause bleeding or mucosal lesion of the patient.

When endoscopic equipment is used with other medical electrical equipment advice on the avoidance of potential safety hazards caused by their use together shall also be given.



Failure of the HF SURGICAL EQUIPMENT could result in an unintended increase of out put power.

A statement of compatibility with specific MONITORING NE, A warning that ,unless a compatible MONITORING NE is used with a CONTACT QUALITY MONTIOR, loss of safe contact between the NE and the patient will not result in an auditory alarm.

CAUTION

Do not use the equipment when the power supply exceeds the rated voltage, or the patient, operator, or his assistant may get hurt, and the electrode may be damaged.

Do not connect any equipment when the electrosurgery apparatus is turned on, or the operator or his assistant may get burnt.

When high frequency electric current is required, do not turn on the electrode when it touches with the normal coelom tissue, or it may burn the non-target tissue.

If the bowel is dilated with air, nonflammable gases can replace it, or air dilatation will cause burning or explosion, and the patient's tissue may get burnt.

Avoidance of a safety hazard in the event of explosive gas concentrations being present in the area of use of HF endoscopically -used accessories.

To prevent healthy tissue from getting burnt, please do not turn on the electrode when it touches non-target tissue.

When any part of the target tissue (such as polypus head) touches non-target tissue, please do not turn on output, or the non-target tissue may get burnt.

When the front part of the endoscope is close to or touches the celom tissue, please do not turn on output, or the tissue may get burnt and the endoscope may be damaged.

When the front metal part of the endoscope touches or is close to the electrode, please do not turn on the output.

When the skin of the patients touches one another, please do not turn on the output, or the patient may get burnt.

When the clothes of the patient are wet, please do not turn on the output, or the patient may get burnt.

When the patient touches the operating desk or the metal parts of other equipment, please do not turn on the output, or the patient, operator, or assistant may get burnt.

While putting out, please do not touch cable connector A or let others touch it, or the patient, operator, or assistant may get burnt.

When pull out cable connector A, please do not pluck the cable, or cable connector A may be damaged.

- 1) Connect the equipment and connect the cable of the device.
- 2) Turn on the electrosurgery apparatus
- 3) Depress the foot switch to start the output.
- 4) Pull the sliding handle, and remove the target tissue or freeze petechiae.
- 5) Turn off the electrosurgery apparatus
- 6) Remove the cable from the electrosurgery apparatus and device handle.

#### **3.3.4 Draw out the electrode from the endoscope**



Please do not draw out the electrode with a fast speed, or the blood, grume, or other chipping may spatter, and infection may occur.

#### **CAUTION**

When the electrode is not closed or has not totally draw back into the sheath, please do not withdraw it from the endoscope, or the endoscope or the electrode may be damaged.

#### **CAUTION**

Please do not draw out the electrode when the elevator stretches up, or the electrode will be damaged.

1. If the elevator is in the endoscope, lower the elevator.
2. Draw out the electrode from the endoscope.

#### **3.3.5 Withdraw the electrode from the handle**

1. Circumvolve the retaining ring on the handle to 180 degree until you see the blue mark clearly.
2. Press the button on the handle, and pull out the connector of the electrode from the handle.

# Chapter 4

## *Cleaning, Disinfection, and Sterilization*

The equipment (repeatabe packing) does not undergo sterilization process before delivery. Please clean, disinfect, and sterilize the product before use.

The equipment (disposable packing) has undergone sterilization process. Use it after unpacking, and there is no need to refit. Before unpacking, make sure the package is not damaged, or else the equipment should not be used.

Please clean, disinfect, sterilize, and store the equipment after use. Any improper or incomplete operation during the processes of cleaning, disinfecting, and sterilizing may lead to infection, and the damage of the equipment or its performance.



This chapter does not apply to the equipment (disposable packing).

The equipment (repeatabe packaging) has not undergone sterilization process before delivery. Please follow the instructions of this chapter to clean, disinfect, and sterilize the product before initial use.



The equipment (disposable packaging) has undergone sterilization process before delivery, so it can be used directly (except when the seal is broken). Dispose it in time after use, and cleaning and disinfecting it for a second use is not permitted.

### **4.1 General**

The person in charge of cleaning, disinfection and sterilization should fully understand and abide by all the regulations and policies of the state and the local hospital.

Endoscope room should have specially assigned person to clean, disinfect and sterilize the endoscope equipment. And training of backup staff will be preferred.

All the staff in charge of cleaning, disinfection, and sterilization should understand the items as below fully:

- a), The procedures of cleaning, disinfection and sterilization of the hospital should including:  
Occupational health and safety regulations;
- b), Provisions and policies of the state and local hospital;
- c), The regulations of this user manual;
- d), The mechanical knowledge of the endoscope equipment;
- e), Signs and explanations related to sterile agents.

2.0%-3.2% glutaraldehyde solution may be used to sterilize the accessories of WILSON endoscope, but normal biological monitoring can not be conducted when glutaraldehyde solution is used. Therefore, it is better not to use glutaraldehyde solution on the repeatabe equipment when

other sterilization methods (such as gas sterilization) which can have biological monitoring are applicable.



Improper cleaning and sterilization of the equipment after use may endanger the safety of the patient. The equipment may touch the mucosa. To lower the cross infection among the patients, the equipment should undergo thorough cleaning and sterilization after use



If the equipment is not completely cleaned, it can not be sterilized effectively. Therefore, before sterilization, it must be cleaned thoroughly to eliminate animalcule or organism which can lower the sterilization effect.



The chipping of the patient and the chemical preparations used in cleaning, disinfection, and sterilization are dangerous things. Wearing personal protective tools can prevent the operator from being endangered by dangerous chemical preparations. Appropriate personal protective tools must be put on during the cleaning and sterilization processes. Before leaving the sterilization area, the protective clothing should be taken off.



Follow the cleaning, disinfection and sterilization processes according to the manual on the day the equipment is used. If the processes are delayed, the remaining tissue chippings will coagulation, so it will be hard to conduct effective cleaning, disinfection, and sterilization for the equipment.

#### **Sterilization Procedure**

Water cleaning → soaked in diluted enzyme solution and scrubbing → ultrasonic cleaning (15min) → immersed in 2.0% glutaraldehyde solution (10 hours) →sterile water cleaning → keep for future use.

Pressure vapor sterilization can also be adopted.

#### **4.2 Apparatus for Cleaning, Disinfection and Sterilization**

Put on appropriate personal protective tools according to the instructions below.

1), Prepare below utensils. The amount of detergent, lubricant, and other utensils depends on the number of electrode products that need cleaning, disinfecting, and sterilizing.

2), Inpour detergent and lubricant into the cleaning utensils according to the temperature and concentration suggested by the manufacturer. Inpour cleansing solution that is suitable for ultrasonic cleaners into the later.

##### a), Protective tools

Appropriate personal protective tools include safety goggles, mask, water-proof clothing, and chemical protective gloves.

**b), Utensil for cleansing solution**

The utensil should be deep and big enough so that the electrode can be thoroughly immersed in, and the diameter should not be less than 15cm.

**c), Cleaning solution for immersing**

Use neutral and low foam medical cleansing solution.

**d), Ultrasonic cleaner**

Use medical ultrasonic cleaner with a frequency range between 38-47 kHz, and it should have sufficient depth and diameter so that the electrode can be totally immersed, and its diameter should not be less than 15cm.

**e), Cleaning solution for ultrasonic cleaning**

Use neutral, low foam, non-abrasive medical cleansing solution

**f), Lubricant**

Use emulsive lubricant of medical water solubility or low viscosity. Lubricant of high viscosity is hard to be injected into the entrance of the equipment for cleaning, disinfection, and sterilization.

**g), Utensil for lubricant****h), Cloth without fine hair****i), 70% ethanol or cymene****j), High temperature and pressure sterilizer****4.3 Cleaning**

Not to touch the liquid or the cleansing solution flowing from the inserted part while cleaning, or it may cause infection or skin irritation.

**CAUTION**

While cleaning, disinfecting, and sterilizing, do not coil the Insertion Portion with a diameter of less than 15 cm or the electrode may be damaged.

Brushing in the Diluted Enzyme Solution



Immerse the electrode product in enzyme solution right after use, or it may be impossible to conduct effective cleaning, disinfection and sterilization, and the performance of the electrode will be lowered as well.

1. Disassemble the handle from the electrode.
2. Immerse the handle and the electrode in the enzyme solution for a time period suggested by the manufacturer. If the period is not provided, then immerse them for 5 minutes to 3 hours.

Ultrasonic cleaning.

1. Immerse the handle and the electrode in the ultrasonic cleaner with cleansing solution.
2. Ultrasonic cleaning for 15 minutes. For detailed information on ultrasonic cleaning, please refer to the user manual.

3. Take out the electrode and the handle.
4. Clean the electrode and the handle with clean water, wiping out the remains of the cleansing solution.
5. Disinfection and Sterilization



If electrolytic ionized water is used to disinfect the equipment, please make sure the PH value of the ionized water is between 2.5-2.7, and the immersing time should be strictly controlled as well. The equipment will be damaged if the PH value is too low or the immersing time is too long.

Applicable sterilization methods for our product:

- 1), Immersed in 2% glutaraldehyde solution (disinfection: 20-30 min; sterilization: 10 hours);
- 2), Sterilize in high pressure steam cleaner with a 126°C temperature for 20-30 minutes. After high temperature sterilization, let the equipment cool down to the room temperature. An abrupt change of the temperature will damage the equipment.

## Chapter 5

### Storage



Do not store the electrode product in a damp environment with a high temperature, or the equipment will be infected by bacteria, so the patient may be infected and the tissue will rankle.

#### 5.1 Check before storage

Follow below steps to check the sterile packaging before storage.

1. Make sure the sterile packaging of the electrode product (disposable packaging) is not broken or tightly sealed.
2. Make sure the electrode product (disposable packaging) is water proof.

#### 5.2 Storage requirement

Put the sterile packaging of the equipment in a dry and clean place. And it should avoid direct sunshine. Make sure the packed equipment not be pressed by surrounding objects. Meanwhile, please abide by the additional storage conditions suggested by the sterile packaging manufacturer.

#### 5.3 Storage conditions:

|                       |  |
|-----------------------|--|
| Ambient Temperature:  | -40°C to 70°C;   |
| Relative Humidity:    | 10% to 95%;  |
| Atmospheric Pressure: | 700hPa-1060hPa (0.7 to 1.1kgf/cm <sup>2</sup> ) (10.2 to15.4 psia) |

# Chapter 6

## Disposal of waste



The used disposable electrode products and the discarded repeatable ones should be controlled and disposed together, or they may cause pollution to the environment and the public, and cause bad consequences.

### 6.1 Waste control

The used disposable electrode products and the discarded repeatable ones should be collected together and closed off. They should never be stored at will.

### 6.2 The Disposal of the waste

The waste of the electrode products should be destroyed and disposed according to related local law and regulatory requirements of the state or area. Randomly cast off is strictly forbidden.

# Chapter 7

## Service information

If you have any questions about any information in these instructions, please contact our by the following information



**WILSON INSTRUMENTS (SHA) CO., LTD.**

**25D, He Yi Business Plaza No.420, Jiang Ning Rd. Shanghai, China. (200041)**

**Tel:+0086-21-66311471**

**Fax:+0086-21-66311472**



**EC Representative**

**Company: Lotus Global Co., Ltd.**

**Address: 15 Alexandra Road, London, NW80DP, United Kingdom**

**Contact Person: Peter**

**Tel: +0044-20-75868010**

**Fax: +0044-20-79006187**