

Muskoka®

Clairemont

ELEGANT ELECTRIC FIREPLACE
with corner option

FOYER ÉLÉGANT
avec coin facultatif

CHIMENEA ELEGANTE
con opción para poner en rincon

Assembly Instructions
Instructions d'assemblage
Instrucciones de montaje



MEF2822CWG

SAVE THESE INSTRUCTIONS
CONSERVER CES INSTRUCTIONS
GUARDE ESTAS INSTRUCCIONES

REV04



TIPS FOR THE ASSEMBLY OF YOUR NEW MANTEL

- Before you begin assembly, locate the instructions and hardware. Take out all the parts and compare them to the diagrams below. Be sure you have all the parts and can identify them.
- A helping hand is always good. Assemble your mantel with an adult assistant if possible. Some pieces are heavy and will need to be held by a helper. Assembly time will take approximately 30-60 minutes.

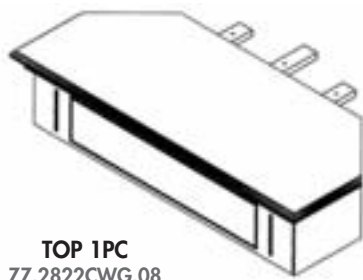

TOP 1PC
ZZ.2822CWG.08

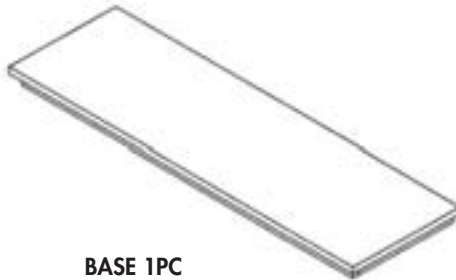

BASE 1PC
ZZ.2822CWG.01

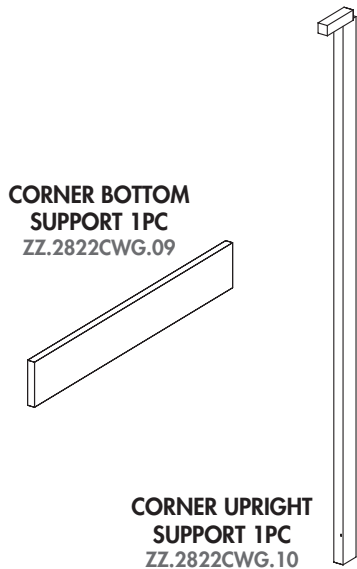

CORNER BOTTOM SUPPORT 1PC
ZZ.2822CWG.09

CORNER UPRIGHT SUPPORT 1PC
ZZ.2822CWG.10

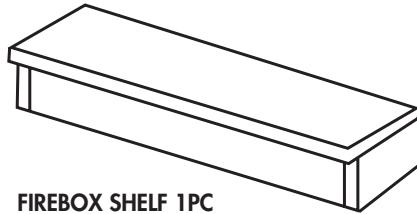

FIREBOX SHELF 1PC
ZZ.2822CWG.11

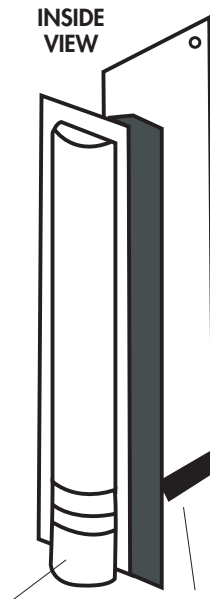

LEFT FRONT PANEL 1PC
ZZ.2822CWG.05

LEFT SIDE PANEL 1PC
ZZ.2822CWG.03

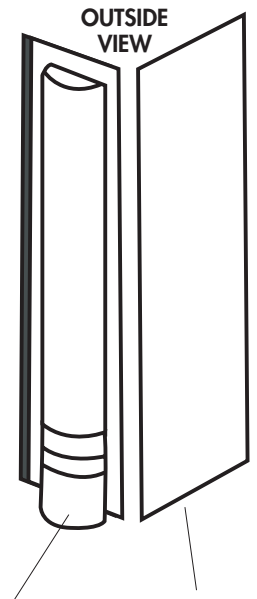

RIGHT FRONT PANEL 1PC
ZZ.2822CWG.04

RIGHT SIDE PANEL 1PC
ZZ.2822CWG.02

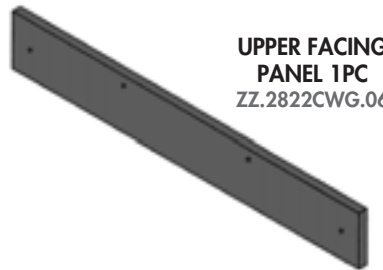

UPPER FACING PANEL 1PC
ZZ.2822CWG.06



LOWER FACING PANEL 1PC
ZZ.2822CWG.07



CORNER ATTACHMENT 1PC
ZZ.2822CWG.08-1

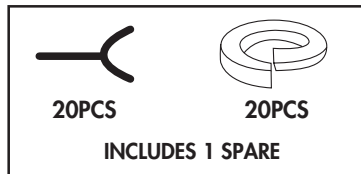

WINGNUT AND LOCK WASHER

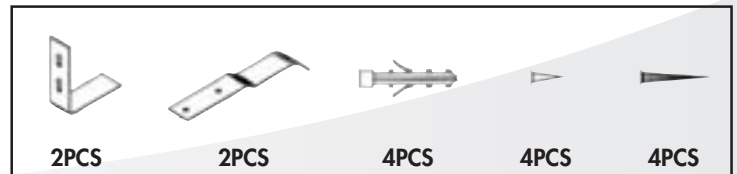

ANTI-TIP DEVICE 2 SETS

GET READY TO START

Before assembly, use scissors to unwrap the parts from the packaging. DO NOT use a box cutter or exacto-knife as you may cut into the mantel pieces inside the box and damage the finish. Check for the hardware bag which is red and located inside the packaging, taped to the top box. Be sure you DO NOT discard any pieces.

Step 1

Locate the base and place it on the floor. Do not put it up against the wall at this point in the assembly, as you need to get in behind the mantel to insert several wingnuts, lock washers and firebox screws.

Step 2

Locate the left side panel and the left front panel. Facing the front of the base, take the left side panel, positioning it so the holes in the blocks on the bottom line up with the holes on the base. Position the left front panel next to the left side panel, lining up the holes in the blocks with the holes on the base. Attach the left front and side panel to the base by inserting and tightening 1 wingnut and 1 lock washer to each piece. Attach the left side and front panels together by inserting and tightening 3 wingnuts and 3 lock washers.

Step 3

Repeat Step 2, but with the right side panel and the right front panel.

Step 4

Locate the lower facing panel and the firebox shelf. Attach the lower facing panel by placing the granite side to the front then line up the holes on each side and insert 1 wingnut and 1 lock washer into each. Place the firebox shelf in behind, right up against the lower facing panel.

Step 5

Locate the granite upper facing panel that will be attached to the left and right legs and will sit above the firebox. Position this panel with the granite side facing the front of the mantel. Line up the holes on each side and insert and tighten 1 wingnut and 1 lock washer on each side.

Step 6

Get your assistant and locate the top of your mantel. This top is very heavy. It will take 2 people to lift and position it in place. Ensure the top goes over the positioning guide located on the header. The top must go over this guide to be positioned correctly. Line up the holes on the top of the mantel, insert and tighten 5 wing nuts and lock washers.

Step 1

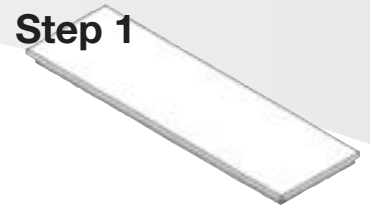

Step 2



Step 4

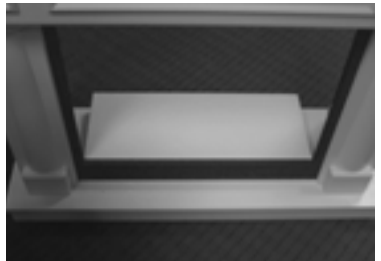

Step 5



Step 6



Step 7

If you are using this mantel in a corner application, locate the triangular piece of wood which attaches to the mantel to create the corner unit. You must attach this piece for all corner applications. Slide the corner bottom support into the channel located at the middle of the back of the hearth base. Place the top corner attachment on the floor upside down. Protect it from damage. Attach the corner upright support to the corner attachment by lining up the hole in the corner upright with hole in the corner top insert with 1 nut and 1 lock washer. Simply take the triangle and slide the brackets with the holes onto the pins which are already attached to the mantel. Once the triangle is attached, push it up so it is level with the mantel and lock it into place. To lock it into place simply turn the horizontal wooden blocks attached to the underside of the mantel into a vertical position to support the weight of the corner triangle. Now attach the corner bottom support to the corner upright support by insert and tightening 1 wing and 1 lock washer.

Step 8

Take your electric firebox out of its packaging and position it between the 2 legs of the mantel. Once you are close to the wall, plug the firebox into the nearest outlet.

The firebox comes with 3 metal brackets and 20 black screws. These metal brackets must be attached to both the sides of the firebox and the mantel to ensure that your firebox does not move around as you use it. 2 of the brackets have 2 large holes on one side. These large holes line up with 2 screws on the side of the firebox. The other screws provided must be inserted into the holes at the other end of the bracket and into the firebox. The other side of each bracket attaches to the mantel.

The 3rd bracket has no holes on 1 side. That side should go up against the firebox top but should not be attached as the heater sits right underneath the bracket. Only the mantel side should be attached.

If you have any questions about the firebox please reference the installation instructions that come with the firebox. Please reference the Quick Tips section of that instruction manual.

NOTE: Some fireboxes come with pre-attached trims

Step 9

You are now ready to position your mantel against the wall. This step requires 2 people to move the unit.

Anti-tipping device

At this point you must attach the anti-tipping device to your mantel and your wall. This device is a safety feature that will prevent your mantel from tipping over if a weight is applied which can unbalance the unit.

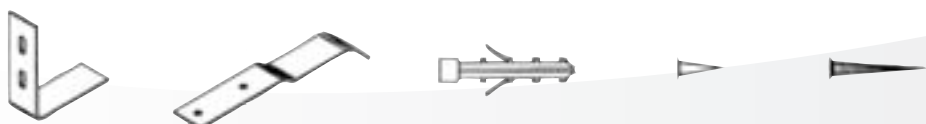
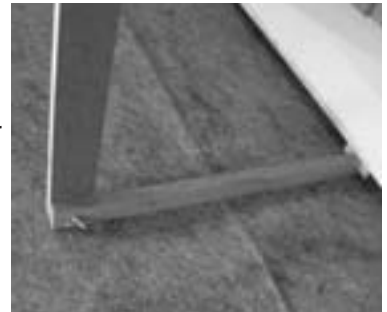

WARRANTY

Greenway Home Products is pleased to offer in-home warranty repairs. Please refer to your Firebox Use and Care Guide for warranty information on your Firebox.

DO NOT RETURN THIS PRODUCT TO THE STORE:

Please contact Customer Service at: **1-866-253-0447**

Monday to Thursday from 8:30AM to 5:00PM (EST), Friday from 8:30AM to 4:00PM (EST)

Web: www.greenwayhp.com

Email: support@greenwayhp.com

Canada: 400 Southgate Dr., Guelph, Ontario, Canada, N1G 4P5

USA: 6507 Fairfield Dr., Northwood, Ohio, USA, 43619

Limited Warranty Definitions:

Greenway Home Products:

(Greenway) Manufacturer.

Mantel: Mantel manufactured by Greenway Home Products.

Purchaser: Purchaser of the Mantel

Distributor: Facility authorized to sell Greenway Home Products.

Warranty Card Greenway Home Products Limited Warranty Registration Card identifying the Purchaser and product model.

Greenway Limited Warranty:

Greenway warrants to the Purchaser that the Mantel is free from defects in material and workmanship, under normal use and service, for 1 year (1 year limited parts) from the date of purchase.

All warranty repairs must be preauthorized by Greenway Home Products. Greenway will, at its' option, replace or repair free of charge any defective part, which the Purchaser shall notify their Distributor or Greenway Home Products within the warranty period. The obligation of Greenway Home Products under this warranty, is expressly limited to such replacement or repairs.

The provisions of this limited warranty shall not apply to the following:

1. Accidents.
2. Unauthorized repairs or alterations.
3. Normal maintenance.
4. Changes made to other units manufactured after this mantel was manufactured.
5. Incidental damages caused by failure of the mantel such as inconvenience or loss of use.
6. Improper installation.

The provisions of this limited warranty shall not apply to deterioration due to wear and exposure beyond the following limitations:

1. For 180 days from the date of purchase for exterior finished surfaces.

Due to the properties of natural wood, Greenway Home Products makes no warranty against mineraling of wood components.

Greenway Limited Warranty is void unless the following conditions are adhered to:

1. Warranty registration must be completed and returned to a Greenway Home Products.
2. All warranty repairs must be preauthorized by a Greenway repair facility.
3. Greenway reserves the right to inspect defective parts that have been replaced under warranty. Dealer is expected to hold defective parts for 60 days.
4. Only parts and accessories and other material, available through Greenway Home Products are to be used in the performance of warranty service.
5. Purchasers are responsible for presenting/notifying their Distributor as soon a problem exists. The warranty repairs should be completed in a reasonable amount of time from the date of authorization. Not to exceed 30 days past notification.

This limited warranty is expressly in lieu of any other expressed or implied warranty, including any implied warranty or merchantability or fitness for a particular purpose and of any obligations or liabilities on Greenway Home Products which neither assumes nor authorizes any other person to assume for it any other liability in connection with the Mantel manufactured by it.

The warranty is null and void if used in commercial or industrial applications.

