

# EDAN

## M3B

Vital Signs Monitor

Release 1.0



## **About this Manual**

P/N: 01.54.455380-10

Release Date: July 2011

© Copyright EDAN INSTRUMENTS, INC. 2011. All rights reserved.

## **Statement**

This manual will help you understand the operation and maintenance of the product better. It is reminded that the product shall be used strictly complying with this manual. User's operation failing to comply with this manual may result in malfunction or accident for which EDAN INSTRUMENTS, INC. (hereinafter called EDAN) can not be held liable.

EDAN owns the copyrights of this manual. Without prior written consent of EDAN, any materials contained in this manual shall not be photocopied, reproduced or translated into other languages.

Materials protected by the copyright law, including but not limited to confidential information such as technical information and patent information are contained in this manual, the user shall not disclose such information to any irrelevant third party.

The user shall understand that nothing in this manual grants him, expressly or implicitly, any right or license to use any of the intellectual properties of EDAN.

EDAN holds the rights to modify, update, and ultimately explain this manual.

## **Responsibility of the Manufacturer**

EDAN only considers itself responsible for any effect on safety, reliability and performance of the equipment if:

Assembly operations, extensions, re-adjustments, modifications or repairs are carried out by persons authorized by EDAN, and

The electrical installation of the relevant room complies with national standards, and

The instrument is used in accordance with the instructions for use.

Upon request, EDAN may provide, with compensation, necessary circuit diagrams, and other information to help qualified technician to maintain and repair some parts, which EDAN may define as user serviceable.

## Terms Used in this Manual

This guide is designed to give key concepts on safety precautions.

### **WARNING**

A **WARNING** label advises against certain actions or situations that could result in personal injury or death.

### **CAUTION**

A **CAUTION** label advises against actions or situations that could damage equipment, produce inaccurate data, or invalidate a procedure.

### **NOTE**

A **NOTE** provides useful information regarding a function or a procedure.

# Table of Contents

<b>Chapter 1 Intended Use and Safety Guidance .....</b>	<b>1</b>
1.1 Intended Use.....	1
1.2 Safety Guidance .....	1
1.2.1 Environment.....	1
1.2.2 Power Source Requirements .....	1
1.2.3 Grounding the Monitor .....	1
1.2.4 Equipotential Grounding.....	2
1.2.5 Condensation.....	2
1.2.6 Safety Precautions.....	2
1.2.7 Explanation of Symbols on the Monitor .....	5
<b>Chapter 2 Installation of Monitor .....</b>	<b>7</b>
2.1 Opening the Package and Checking.....	7
2.2 Connecting the Power Cable.....	7
2.3 Powering on the Monitor .....	7
2.4 Connecting Sensor to Patient .....	8
2.5 Checking the Recorder.....	8
<b>Chapter 3 Introduction.....</b>	<b>9</b>
3.1 General Information .....	9
3.2 Screen Display .....	10
3.3 Button Functions .....	14
3.4 Interfaces.....	16
3.5 Built-in Rechargeable Battery.....	18
<b>Chapter 4 System Menu .....</b>	<b>20</b>
4.1 Patient Setup.....	20
4.2 Default Setup.....	21
4.3 System Setup.....	21
4.4 Selection.....	22
4.5 Deleting Data .....	25
4.6 Version.....	26
4.7 Time Setup .....	26
4.8 CO <sub>2</sub> Setup.....	27
4.9 Alarm Setup.....	28
4.10 Maintenance .....	29
4.11 Data Storing.....	31
4.12 Sleep Mode.....	34
<b>Chapter 5 Alarm.....</b>	<b>36</b>
5.1 Alarm Modes.....	36
5.1.1 Alarm Level.....	36
5.1.2 Alarm Modes.....	36

5.1.3 Alarm Setup.....	40
5.2 Alarm Cause.....	41
5.3 Silence.....	41
5.4 Parameter Alarm.....	41
5.5 When an Alarm Occurs.....	42
5.6 Testing Alarms.....	42
<b>Chapter 6 Trend and Recording.....</b>	<b>43</b>
6.1 General Information on Recording.....	43
6.2 Recorder Operations.....	43
<b>Chapter 7 Maintenance/Cleaning.....</b>	<b>45</b>
7.1 System Check.....	45
7.2 General Cleaning.....	45
7.3 Sterilization.....	46
7.4 Disinfection.....	46
7.5 Replacement of Fuse.....	47
7.6 Cleaning Battery and Battery Compartment Cover.....	47
<b>Chapter 8 SpO<sub>2</sub> Monitoring.....</b>	<b>48</b>
8.1 What is SpO <sub>2</sub> Monitoring.....	48
8.2 Precautions During SpO <sub>2</sub> /Pulse Monitoring.....	49
8.3 Monitoring Procedure.....	49
8.4 Limitations for Measurement.....	50
8.5 Alarm Setup Menu.....	50
8.6 Alarm Description.....	51
8.7 Maintenance and Cleaning.....	53
<b>Chapter 9 CO<sub>2</sub> Monitoring.....</b>	<b>54</b>
9.1 General Information.....	54
9.2 Preparing for CO <sub>2</sub> Monitoring.....	55
9.3 CO <sub>2</sub> Setup Menu.....	59
9.3.1 CO <sub>2</sub> Setup.....	59
9.3.2 CO <sub>2</sub> Alarm Setup.....	61
9.4 Alarm Information and Prompt.....	64
9.5 Maintenance and Cleaning.....	65
<b>Chapter 10 Other Functions.....</b>	<b>66</b>
10.1 Nurse Call.....	66
10.2 Wireless Network.....	66
<b>Chapter 11 Accessories and Ordering Information.....</b>	<b>67</b>
<b>Chapter 12 Warranty and Service.....</b>	<b>71</b>
12.1 Warranty.....	71
12.2 Contact Information.....	71
<b>Appendix I Specifications.....</b>	<b>72</b>
A1.1 Classification.....	72

A1.2 Specifications .....	72
A1.2.1 Size and Weight.....	72
A1.2.2 Environment.....	72
A1.2.3 Display .....	73
A1.2.4 Battery .....	73
A1.2.5 Recorder .....	74
A1.2.6 Review.....	74
A1.2.7 SpO <sub>2</sub> .....	74
A1.2.8 CO <sub>2</sub> .....	75
A1.2.9 Wireless Network.....	76
<b>Appendix II EMC Information.....</b>	<b>77</b>
A2.1 Electromagnetic Emissions - for all EQUIPMENT and SYSTEMS .....	77
A2.2 Electromagnetic Immunity - for all EQUIPMENT and SYSTEMS .....	77
A2.3 Electromagnetic Immunity-for EQUIPMENT and SYSTEMS that are not LIFE-SUPPORTING.....	79
A2.4 Recommended Separation Distances .....	80

# Chapter 1 Intended Use and Safety Guidance

## 1.1 Intended Use

The M3B Vital Signs Monitor (hereinafter called monitor) is intended to be used for non-invasive continuous monitoring of SpO<sub>2</sub> (oxygen saturation of the blood) and CO<sub>2</sub>.

The monitor is intended to be used only under regular supervision of clinical personnel. It is applicable to adult, pediatric, and neonatal usage in a hospital environment and intra-hospital moves.

The monitor is equipped with alarms that indicate system faults (such as loose or defective electrodes), physiologic parameters that have exceeded the limits set by the operator, or both.

## 1.2 Safety Guidance

### 1.2.1 Environment

Follow the instructions below to ensure a completely safe electrical installation. The environment where the monitor will be used should be reasonably free from vibration, dust, corrosive or explosive gases, extremes of temperature, humidity, and so on. For a cabinet mounted installation, allow sufficient room at the front for operation and sufficient room at the rear for servicing with the cabinet access door open.

The monitor operates within specifications at ambient temperatures between 5°C and 40°C. Ambient temperatures that exceed these limits could affect the accuracy of the instrument and cause damage to the modules and circuits. Allow at least 2 inches (5cms) clearance around the instrument for proper air circulation.

### 1.2.2 Power Source Requirements

Refer to *Appendix I*.

### 1.2.3 Grounding the Monitor

To protect the patient and hospital personnel, the cabinet of the monitor must be grounded. Accordingly, the monitor is equipped with a detachable 3-wire cable which grounds the instrument to the power line ground (protective earth) when plugged into an appropriate 3-wire receptacle. If a 3-wire receptacle is not available, consult the hospital electrician.

Connect the grounding wire to the equipotential grounding terminal on the mains system. If it is not evident from the instrument specifications whether a particular instrument combination is hazardous or not, for example due to summation of leakage currents, the user should consult the manufacturers concerned or an expert in the field, to ensure that the necessary safety of all instruments concerned will not be impaired by the proposed combination.

## 1.2.4 Equipotential Grounding

Protection class 1 instruments are already included in the protective grounding (protective earth) system of the room by way of grounding contacts in the power plug. For internal examinations on the heart or the brain, the monitor must have a separate connection to the equipotential grounding system. One end of the equipotential grounding cable (potential equalization conductor) is connected to the equipotential grounding terminal on the instrument rear panel and the other end to one point of the equipotential grounding system. The equipotential grounding system assumes the safety function of the protective grounding conductor if ever there is a break in the protective grounding system. Examinations in or on the heart (or brain) should only be carried out in medically used rooms incorporating an equipotential grounding system. Check each time before use that the instrument is in perfect working order. The cable connecting the patient to the instrument must be free of electrolyte.

---

### **WARNING**

If the protective grounding (protective earth) system is doubtful, the monitor must be supplied by internal power only.

---

## 1.2.5 Condensation

Make sure that during operation, the instrument is free of condensation. Condensation can form when equipment is moved from one building to another, thus being exposed to moisture and differences in temperature.

## 1.2.6 Safety Precautions

**WARNING** and **CAUTION** messages must be observed. To avoid the possibility of injury, observe the following precautions during the operation of the instrument.

---

### **WARNING**

- 1 This monitor is not a device for treatment purpose.
  - 2 The monitor is provided for the use of qualified physicians or personnel professionally trained. And they should be familiar with the contents of this user manual before operation.
  - 3 Only qualified service engineers can install this equipment. And only service engineers authorized by EDAN can open the shell.
  - 4 **EXPLOSION HAZARD**-Do not use the device in a flammable atmosphere where concentrations of flammable anesthetics or other materials may occur.
  - 5 Always keep the battery away from fire.
  - 6 **SHOCK HAZARD**- the power receptacle must be a three-wire grounded outlet. A hospital grade outlet is required. Never adapt the three-prong plug from the monitor to fit a two-slot outlet.
  - 7 When the monitor and electrosurgical device are used together, the user (physician or nurse) should guarantee the safety of patient.
-



---

---

**WARNING**

---

---

- 8 If liquid is inadvertently splashed on the equipment or its accessories, or may enter the conduit or inside the monitor, contact local Customer Service Center.
  - 9 Do not attempt to connect or disconnect a power cord with wet hands. Make certain that your hands are clean and dry before touching a power cord.
  - 10 Accessory equipment connected to the analog and digital interfaces must be certified according to the respective IEC/EN standards (e.g. IEC/EN60950 for data processing equipment and IEC/EN60601-1 for medical equipment). Furthermore all configurations shall comply with the valid version of the system standard IEC/EN60601-1-1. Everybody who connects additional equipment to the signal input connector or signal output connector configures a medical system, and is therefore responsible that the system complies with the requirements of the valid version of the system standard IEC/EN 60601-1-1. If in doubt, consult our technical service department or your local distributor.
  - 11 The simultaneous use of cardiac pacemaker and other patient-connected equipment may cause safety hazard.
  - 12 The equipment can provide protective means to prevent the patient from being burned when used with HF SURGICAL EQUIPMENT.
  - 13 Do not unplug the USB storage during storing data. If the damaged data caused by unplugging the USB storage during data storing can not be deleted on the monitor, the user can delete it on the PC.
  - 14 Do not solder the leading wire and the battery terminal directly.
  - 15 If liquid leaking from the battery gets into your eyes, onto your skin or clothes, do not rub your eyes. Wash them well with clean water and go to see a doctor immediately.
  - 16 Only patient cable and other accessories supplied by EDAN can be used. Or else, the performance and electric shock protection can not be guaranteed, and the patient may be injured.
  - 17 Do not use a battery with serious scar or deformation.
  - 18 Stop using the battery if abnormal heat, odor, discoloration, deformation or abnormal condition is detected during use, charge, or storage. Keep it away from the monitor.
  - 19 Do not sterilize the monitor, recorder or any accessories.
  - 20 Do not touch the patient, bed or instrument during defibrillation.
  - 21 Please set the alarm according to the individual status of patient to avoid delaying treatment. Ensure there will be alarm audio prompt when alarming.
  - 22 Devices connecting with monitor should be equipotential.
  - 23 The monitor is equipped with a wireless AP via network interface to receive RF electromagnetic energy. Therefore, any other equipment complies with CISPR radiation requirements may also interfere with the wireless communication and make it interrupted.
  - 24 Wireless LAN equipment contains an intentional RF radiator that has the potential of interfering with other medical equipment, including patient implanted devices.
  - 25 Please disinfect timely to prevent cross infection between patients.
- 
-

---

---

**WARNING**

---

---

- 26 During monitoring, if the power supply is off and there is no battery for standby, the monitor will be off, and only the patient information and alarm settings can be saved. After reconnecting the power supply, the user should turn on the monitor for monitoring.
  - 27 CO<sub>2</sub> module shall be avoided from crash and vibration.
- 
- 

---

---

**CAUTION**

---

---











- 1 Federal law restricts this device to sale by or on the order of a physician.
  - 2 **Electromagnetic Interference-** Ensure that the environment in which the monitor is installed is not subject to any sources of strong electromagnetic interference, such as radio transmitters, mobile telephones, etc.
  - 3 The device is designed for continuous operation and is “ordinary” (i.e. not drip or splash-proof).
  - 4 Do not immerse transducers in liquid. When using solutions, use sterile wipes to avoid pouring fluids directly on the transducer.
  - 5 Remove a battery whose life cycle has expired from the monitor immediately.
  - 6 The device and accessories are to be disposed of according to local regulations after their useful lives. Alternatively, they can be returned to the dealer or the manufacturer for recycling or proper disposal.
  - 7 Keep the environment clean. Avoid vibration. Keep it far from corrosive medicine, dust area, high-temperature and humid environment.
  - 8 Avoid liquid splash and excessive temperature. The temperature must be kept between 5°C and 40°C while working. And it should be kept between -20°C and 55°C during transportation and storage.
  - 9 Before use, the equipment, patient cable and sensor should be checked. Replacement should be taken if there is any evident defectiveness or aging symptom which may impair the safety or performance.
  - 10 If the monitor gets damp, put it in dry circumstance to dry it until it can work normally. If liquid pours on the monitor, please contact the service personnel authorized by EDAN.
  - 11 Setting alarm limits to extreme values can render the alarm system useless.
  - 12 A potential hazard can exist if different alarm presets are used for the same or similar equipment in any single area.
- 
- 



**NOTE:**

- 1 Position the device in a location where the operator can easily see the screen and access the operating controls.
- 2 This equipment is not intended for family usage.
- 3 If the device is discolored or damaged, then discontinue the use of the device.
- 4 The equipment can protect against the effects of the discharge of a defibrillator.

- 5 The monitor can only be used on one patient at a time.
- 6 The equipment is calibrated to display functional oxygen saturation.
- 7 The pictures and interfaces in this manual are for reference only.

### 1.2.7 Explanation of Symbols on the Monitor

	<p>This symbol indicates that the instrument is IEC/EN60601-1 Type BF equipment. The unit displaying this symbol contains an F-Type isolated (floating) patient applied part providing a high degree of protection against shock, and is suitable for use during defibrillation.</p>
	<p>Caution</p>
	<p>Consult Instructions for Use</p>
	<p>Equipotentiality</p>
	<p>Stand-by. It designates that the switch or switch position which one part of the monitor has been switched on, while the monitor is at the status of stand-by.</p>
	<p>Serial number</p>
	<p>The symbol indicates that the device complies with the European Council Directive 93/42/EEC concerning medical devices.</p>
	<p>Authorised representative in the European community</p>
	<p>Date of manufacture</p>
	<p>Manufacturer</p>

<b>P/N</b>	Part Number
	Recycle
	The symbol indicates that the device should be sent to the special agencies according to local regulations for separate collection after its useful life.
<b>Rx only</b>	Federal (US) law restricts this device to sale by or on the order of a physician.
	With respect to electrical shock, fire and mechanical hazards only in accordance with UL 60601-1 and CAN/CSA C22.2 No. 601.1

## Chapter 2 Installation of Monitor

### NOTE:

To ensure that the monitor works properly, please read Chapter 1 **Intended Use and Safety Guidance**, and follow the steps before using the monitor.

### 2.1 Opening the Package and Checking

Open the package and take out the monitor and accessories carefully. Keep the package for possible future transportation or storage. Check the components according to the packing list.

- Check for any mechanical damage.
- Check all the cables, modules and accessories.

If there is any problem, contact the manufacturer or local representative immediately.

### 2.2 Connecting the Power Cable

Connection procedure of the AC power line:

- Make sure the AC power supply complies with following specification: 100V-240V~, 50Hz/60Hz.
- Apply the power line provided with the monitor. Plug the power line to input interface of the monitor. Connect the other end of the power line to a grounded 3-phase power output.

### NOTE:

Connect the power line to the jack special for hospital usage.

- Connect to the ground line if necessary. Refer to Chapter **1.2 Safety Guidance** for details.

### NOTE:

When the battery configuration is provided, after the device is transported or stored, the battery must be charged. Switch on AC power supply can charge the battery no matter if the monitor is powered on.

### 2.3 Powering on the Monitor

Power on, LOGO information will be displayed on the screen.

---

#### **WARNING**

Do not use it on any patient if any sign of damage is detected, or the monitor displays some error messages. Contact biomedical engineer in the hospital or Customer Service Center immediately.

---

**NOTE:**

- 1 Check all the functions of the monitor and make sure that the monitor is in good status.
- 2 If rechargeable batteries are provided, charge them after using the monitor every time to ensure the electric power is enough.
- 3 The interval between double presses of **ON/OFF** button should be more than 1 second.
- 4 After continuous 168-hour runtime, please restart the monitor to ensure the monitor's steady performance and long lifespan.

## 2.4 Connecting Sensor to Patient

Connect all the necessary patient sensors between the monitor and the patient.

**NOTE:**

For information on correct connection, refer to related chapters.

## 2.5 Checking the Recorder

If your monitor is equipped with a recorder, open the recorder door to check if paper is properly installed in the slot. If no paper present, refer to Chapter 6 **Trend and Recording** for details.

## Chapter 3 Introduction

### 3.1 General Information

The monitor integrates the function of parameter measurement modules, display, recording and output to compose a compact, portable device. Its built-in replaceable battery provides convenience for patient movement. On the LCD display screen, SpO<sub>2</sub> waveform, CO<sub>2</sub> waveform and all the monitoring parameters can be displayed clearly.

The monitor is a user-friendly device with operations conducted by a few buttons on the front panel. Refer to 3.3 **Button Functions** for details.



Figure 3-1 M3B Vital Signs Monitor

The monitor can monitor:

- SpO<sub>2</sub>: Arterial oxygen saturation (SpO<sub>2</sub>);
  - Pulse Rate (PR);
  - SpO<sub>2</sub> PLETH (Plethysmogram);
- CO<sub>2</sub>: End Tidal CO<sub>2</sub> (EtCO<sub>2</sub>);
  - Fraction of inspired CO<sub>2</sub> (FiCO<sub>2</sub>);
  - Air Way Respiration Rate (AwRR).

The monitor provides extensive functions as visual and audible alarm, net connection, nurse call, recording and storage for trend data, SpO<sub>2</sub>/CO<sub>2</sub> measurements review, net connection, nurse call, alarm events and so on. Recording and mobile storage are optional functions for monitor.

## 3.2 Screen Display

The monitor is equipped with LCD. The patient parameters, waveforms, alarm messages, bed number, time, monitor status and other data can be reflected from the screen.

The screen is divided into three areas:

- 1 Information area ① ④
- 2 Parameter area ②
- 3 Waveform/Trend table/Alarm list area ③

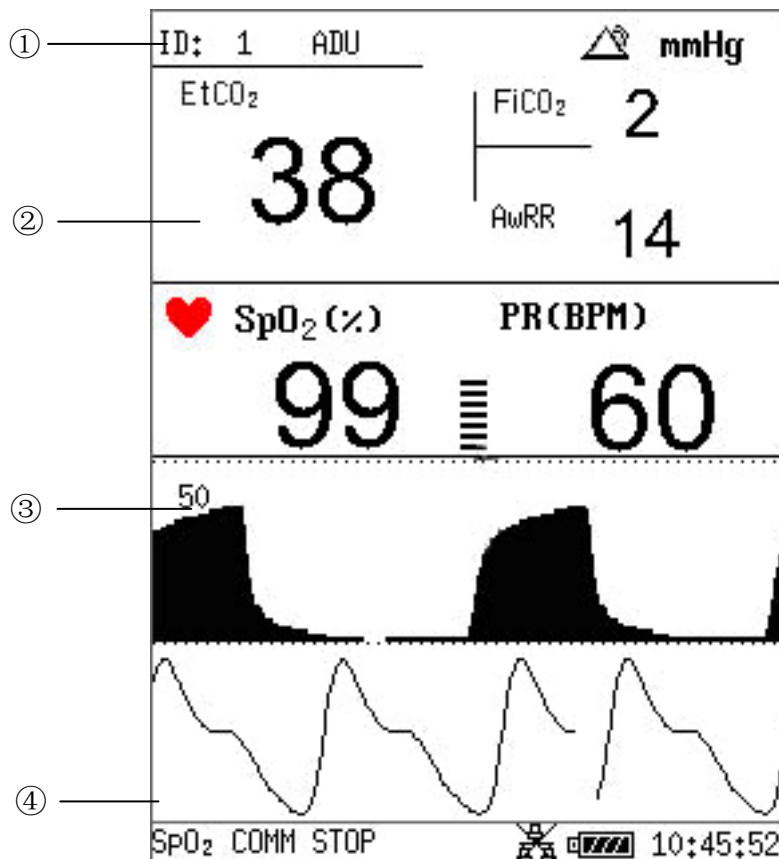

Figure 3-2 Main Display with Waveform



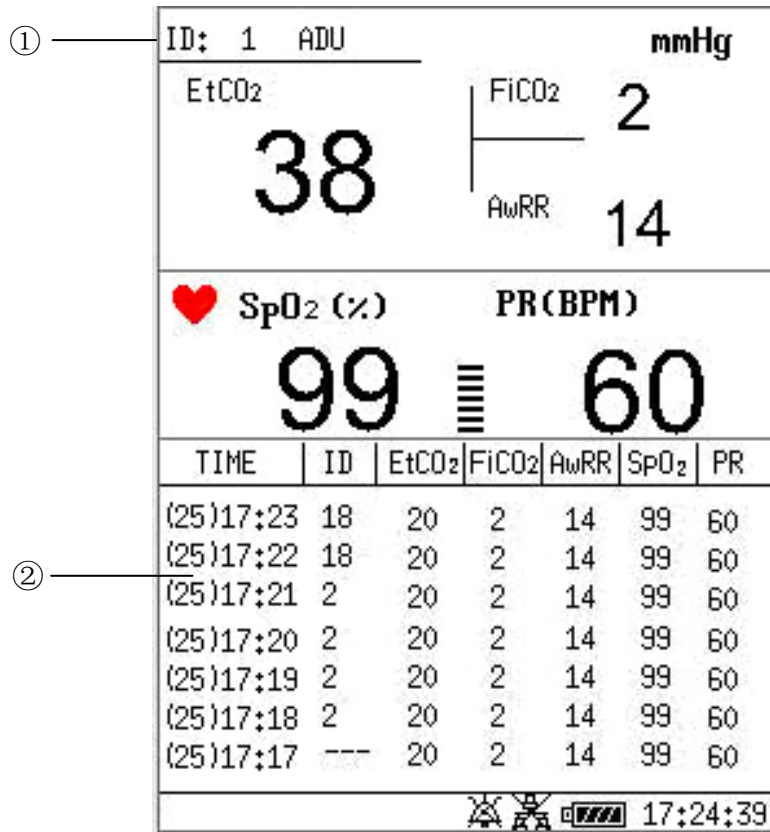

Figure 3-3 Main Display with List

The display on the screen can be changed to a trend graph as follows:

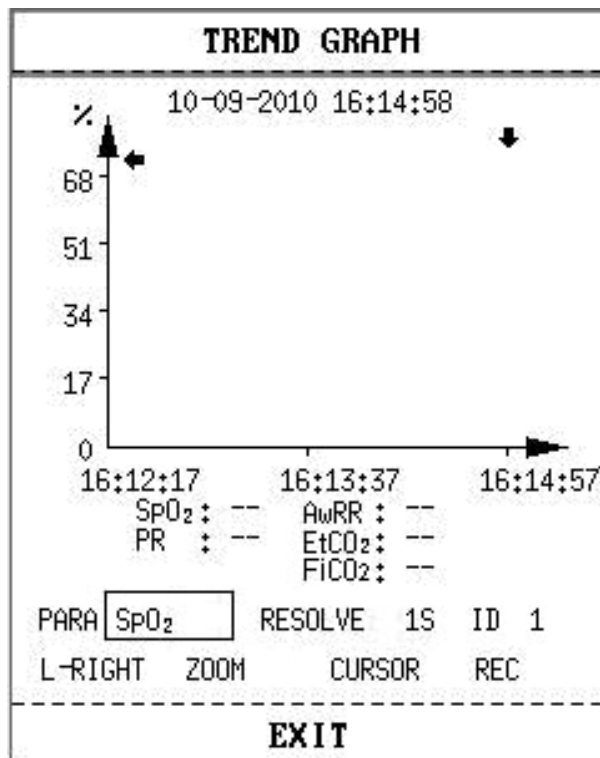











Figure 3-4 Display Trend Graph

The icons on the interface and their meanings are as follows:

	Battery status indicator
	Connected to mains power supply
	Network connection
	Network connection off
	Medium/Low alarm icon
	High alarm
	Audio system off
	Alarm silenced
	Parameter alarm off
<b>ADU</b>	Patient type: ADU
<b>PED</b>	Patient type: PED
<b>NEO</b>	Patient type: NEO
	Heart beat
<b>ID</b>	Current patient ID
<b>10: 45: 52</b>	Current time

### Information Area (① ④)

The Information areas are to display operating status of the monitor and condition of the patient, including the following data:

- Patient ID;
- Signs indicating the net connection status;
- Signs indicating the battery or mains power supply status;
- Current time;
- Signs indicating the sensor off or alarm off.

### Parameter Area (②)

Parameter area is on the right of Waveform area, and parameters are displayed:

SpO<sub>2</sub>:

- SpO<sub>2</sub> (Unit: %)
- PR (Pulse Rate, unit: BPM)

CO<sub>2</sub>:

- EtCO<sub>2</sub> (unit: mmHg, kPa or %)
- FiCO<sub>2</sub> (unit: mmHg, kPa or %)
- AwRR (Unit: times/minute)

### **Waveform Area/Trend Table/Alarm List (③)**

It can display SpO<sub>2</sub> and CO<sub>2</sub> waveform, Trend graph, Trend tab or Alarm list. You can select it in **SELECTION** of **SYSTEM MENU**.

### **Alarm Indicator and Alarm Status**

Under normal status, the alarm indicator does not light.

When an alarm is generated, the alarm indicator lights or flashes. The color of light represents the alarm level. Refer to Chapter 5 **Alarm** for details.

Refer to the relevant content of parameters for alarm information and prompt.

### **Charge Indicator and Charge Status**

To indicate the status of charging: when the battery is being charged, the light turns to yellow; after the charge is finished, the light will be off.

### 3.3 Button Functions

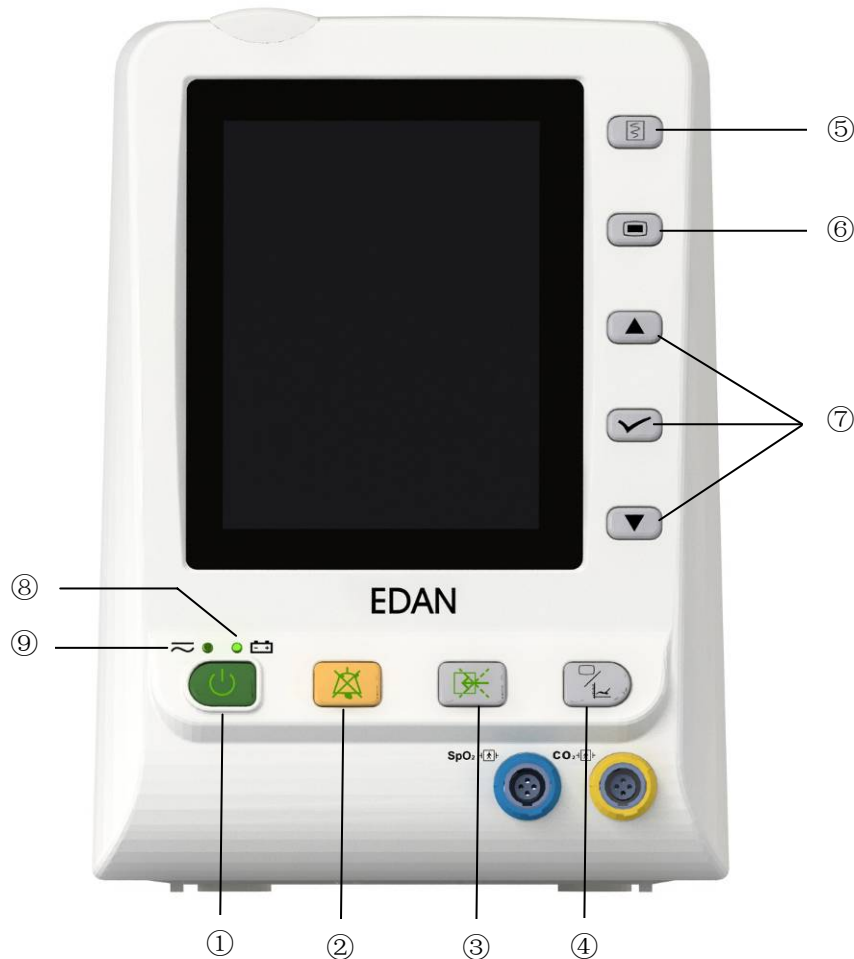





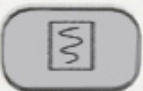







Figure 3-5 Buttons

All the operations to the monitor can be finished by several buttons. They are:

①	<p><b>ON/OFF</b></p> 	<p>When the monitor is off, press this button to switch on the monitor. When the monitor is on, press this button and hold for 2s to switch off the monitor; press this button for less than 1s, the monitor will enter the sleep mode.</p>
②	<p><b>SILENCE</b></p> 	<p>Press this button for less than 2s to silence the audible alarm, then the icon  appears and a message “SILENCE XXX S” shows in the information area. Repress it or wait until the pause time is over, and the audible alarm resumes to the normal monitoring status. You can set the duration for silencing the audible alarm to <b>60s</b>, <b>120s</b> or <b>180s</b>. For more information, please refer to <i>4.10 Maintain</i>.</p> <p>Press this button for more than 2s to turn off the audio system, including audible alarm, key volume and pulse tone.</p>

		Then the icon  displays in the information area. Pressing the button again can resume the audio system.
③	<b>CO<sub>2</sub> START/STOP</b> 	Press to start the CO <sub>2</sub> measuring. During the measuring process, press the button to stop measuring.
④	<b>TREND/WAVEFORM</b> 	Press this button to switch between waveform, trend table and trend graph display.
⑤	<b>RECORD</b> 	Press to print out the currently displayed trend graph, trend table or alarm list.
⑥	<b>MENU</b> 	Press to call up the <b>SYSTEM MENU</b> . Refer to Chapter <b>SYSTEM MENU</b> for details.
⑦	 <b>UP</b>  <b>OK</b>  <b>DOWN</b>	Use the <b>UP/DOWN</b> button to select items in menu, and decrease or increase the items. Confirm the selection by <b>OK</b> button.

The icons on the front panel:

⑧	<b>CHARGE Indicator</b> 	The LED besides this icon indicates the charging status. When the battery is being recharged, the LED is bright.
⑨	<b>POWER Indicator</b> 	The LED besides this icon indicates the power status. When the monitor connects to the mains power supply, the LED is bright.

## 3.4 Interfaces

For the convenience of operator, interfaces of different function are in different sites of the monitor. There is a USB port on rear panel for Data storing function.

### Left side of the monitor

At the left side of the monitor there is the recorder's paper inlet cover (①).



Figure 3-6 Front Panel and Left Panel

### Sensor port on the front panel

Connectors for cables and sensors are as shown in Figure 3-6.

1. SpO<sub>2</sub> sensor connector (②)
2. CO<sub>2</sub> sensor connector (③)

---

### **WARNING**

Only connect the device to EDAN supplied or recommended accessories.

---

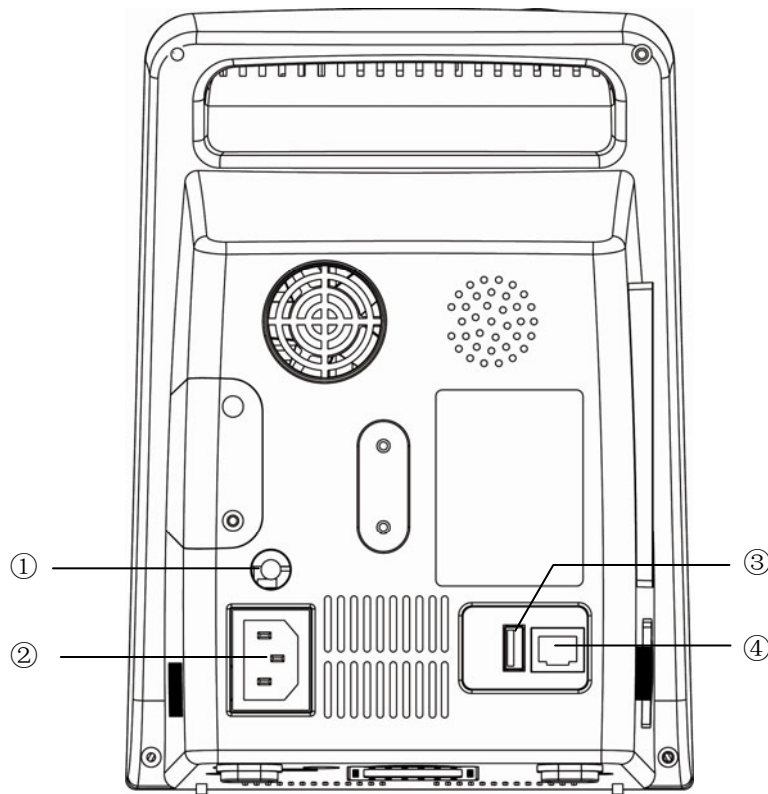

Figure 3-7 Rear Panel of M3B

Sockets on the rear panel are shown in Figure 3-7,

- ① Equipotential grounding terminal for connection with the hospital's grounding system.
- ② Power supply socket: 100V-240V~, 50Hz/60Hz.
- ③ USB connecting port for USB storage.
- ④ Network Interface: Standard RJ45 Socket, for connecting to MFM-CMS of EDAN.

### Bottom panel

There are battery compartment and fuse box at the bottom panel.

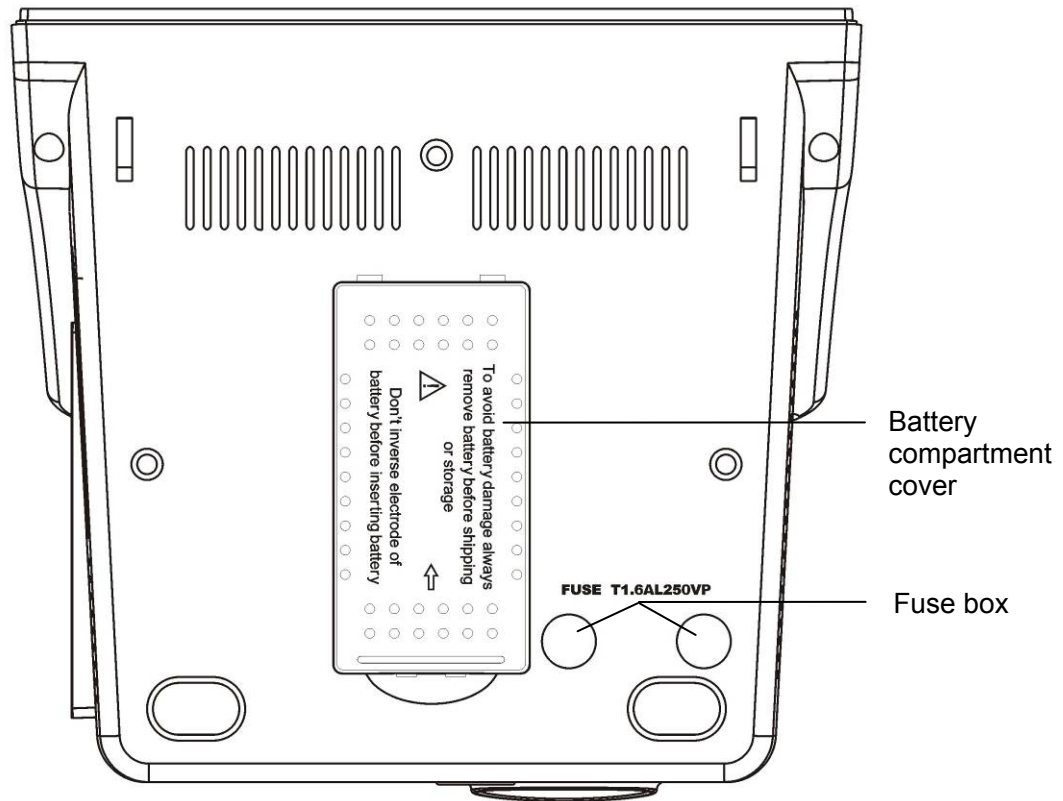







Figure 3-8 Bottom Panel

### 3.5 Built-in Rechargeable Battery

The monitor is equipped with a built-in rechargeable battery. When switching on AC power supply, the battery will be recharged automatically until full electric energy. There is a sign  or  in the lower right corner of screen.

- When the monitor is working with AC mains power, and it has no battery or the battery has full electric energy, it displays .
- When the monitor is working with AC mains power, and the battery is being recharged, this icon flashes .
- When the monitor is working with battery, it displays .

If the monitor is off, you can see charging status from the charger indicator. Battery status light is yellow when charging, off when full.

The battery is 90% to 100% charged after 300min of charging.

#### Replace Battery

During monitoring state or communication state, when the electric energy of battery is low, the icon for indicating battery state will display and flash.

When the lifespan of battery is over, or foul odor and leakage has been detected, please contact the manufacturer or local distributor for replacement of battery.



---

---

**WARNING**

---

---

- 1 Do not unplug the battery when monitoring.
  - 2 The unexpected power supply off can not impact the monitor normal working, if it has battery for standby.
  - 3 Stop using the battery if abnormal heat, odor, discoloration, deformation or abnormal condition is detected during use, recharge, or storage. Keep it away from the monitor.
  - 4 Make sure the monitor is used in the appointed range of voltage so that the effect of power supply can not be noticed.
  - 5 Before using the rechargeable lithium-ion battery (hereinafter called battery), be sure to read the user manual and safety precautions thoroughly.
  - 6 Do not place battery in the monitor with the (+) and (-) in the wrong way around.
  - 7 Do not connect the positive (+) and negative (-) terminals with metal objects, and do not put the battery together with metal objects, which can result in short circuit.
  - 8 Do not heat or throw battery into fire.
  - 9 Do not use, leave battery close to fire or other places where temperature may be above 60°C.
  - 10 Do not immerse, throw, and wet battery in water/seawater.
  - 11 Do not destroy the battery; do not pierce battery with a sharp object such as a needle; do not hit with a hammer, step on or throw to cause strong shock; do not disassemble or modify the battery.
  - 12 Take out the battery before cleaning or delivering.
  - 13 Please take out the battery before storing the monitor for more than 1 month.
- 
-

## Chapter 4 System Menu

The monitor features in flexible configurations. You can configure various aspects of the monitor, including the parameters to be monitored, audio signal volume, and output content.

Press the **MENU** button on the front panel to call up **SYSTEM MENU**. You can perform the following operations in this menu.

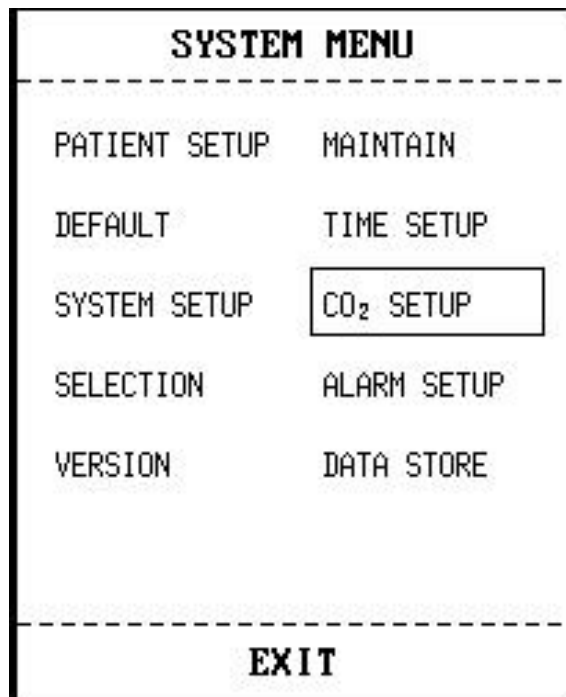

Figure 4-1 System Menu

### 4.1 Patient Setup

Pick **PATIENT SETUP** in **SYSTEM MENU** to open the following menu.

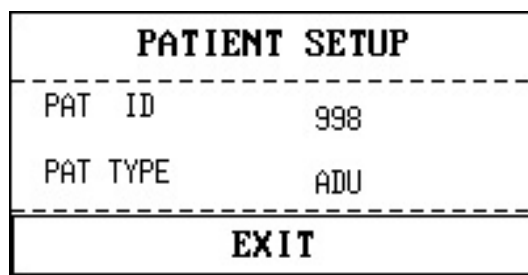

Figure 4-2 Patient Setup

You can set the following patient information:

- **PAT ID:** Patient ID, 1-1000;
- **PAT TYPE:** Patient type; **ADU**, **PED**, or **NEO**.

Press the **UP/DOWN** button to select the items; then press the **OK** button to confirm.

Pick **EXIT** to return to the previous menu.

## 4.2 Default Setup

**NOTE:**

Select any item in this submenu to cancel the current setup and use the selected default setup.

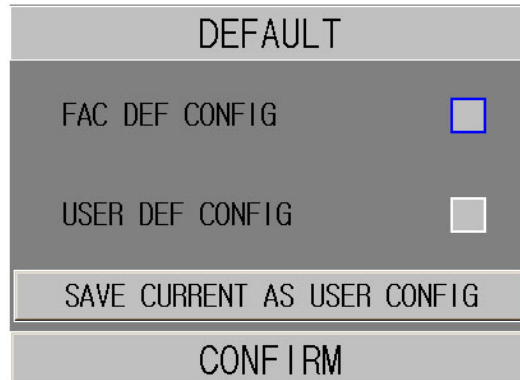

Figure 4-3 Default Menu

- **FAC DEF CONFIG:** factory default configuration.
- **USER DEF CONFIG:** user-defined default configuration.
- **SAVE CURRENT AS USER CONFIG:** Save the current setup as user default configuration.
- **CONFIRM:** Confirm your choice, exit this submenu, and return to the previous menu.

## 4.3 System Setup

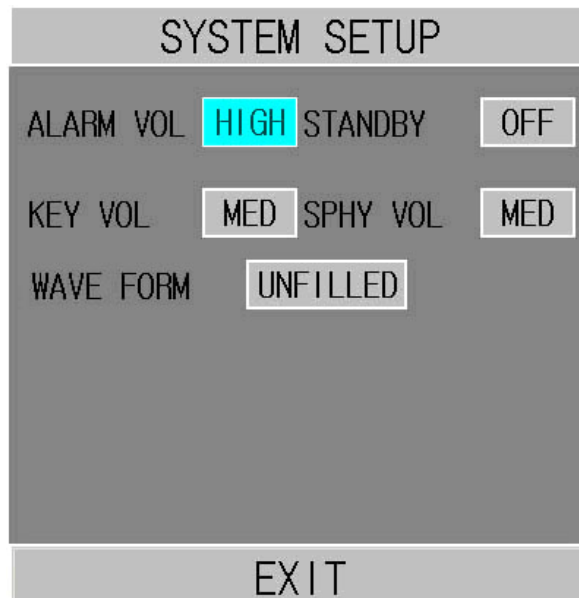

Figure 4-4 System Setup

- **ALARM VOL:** Set alarm volume for high, medium or low level, **HIGH**, **MED** or **LOW** are selectable.
- **STANDBY:** Set it to **ON** or **OFF** to turn on or off the Sleep Mode (Refer to 4.12 for details).

- **KEY VOL:** Set key volume to **HIGH, MED, LOW** or **OFF**.
- **SPHY VOL:** Set sphygmic volume to **HIGH, MED, LOW** or **OFF**.
- **WAVE FORM:** Set displayed waveforms to **UNFILLED** or **FILLED**.
- **EXIT:** Select it to return to the previous menu.

### 4.4 Selection

Select **SELECTION** in **SYSTEM MENU** to access the following submenu, in which five selections are available: **CO<sub>2</sub> TREND TAB**, **SpO<sub>2</sub> TREND TAB**, **ALARM LIST**, **PARAMETER TAB** and **TREND GRAPH**. Only one item can be selected to display information in the lower part of the interface.

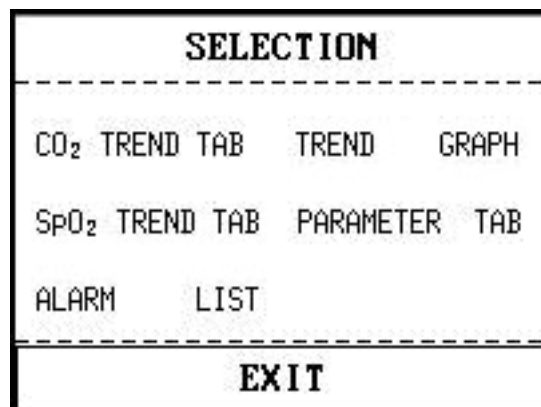

Figure 4-5 Selection

- **CO<sub>2</sub> TREND TAB:** to display CO<sub>2</sub> trend table:

ID: 18 ADU		mmHg		
EtCO <sub>2</sub>		FiCO <sub>2</sub>	2	
<b>20</b>		AwRR	14	
SpO <sub>2</sub> (%)		PR (BPM)		
<b>99</b>		<b>60</b>		
TIME	ID	EtCO <sub>2</sub>	FiCO <sub>2</sub>	AwRR
(18)13:55	18	20	2	14
(18)13:54	18	20	2	14
(18)13:53	2	20	2	14
(18)13:52	2	20	2	14
(18)13:51	2	20	2	14
(18)13:50	2	20	2	14
(18)13:49	---	---	---	---
				13:55:22

Figure 4-6 CO<sub>2</sub> Trend Table

- **SpO<sub>2</sub> TREND TAB:** to display SpO<sub>2</sub> trend table;

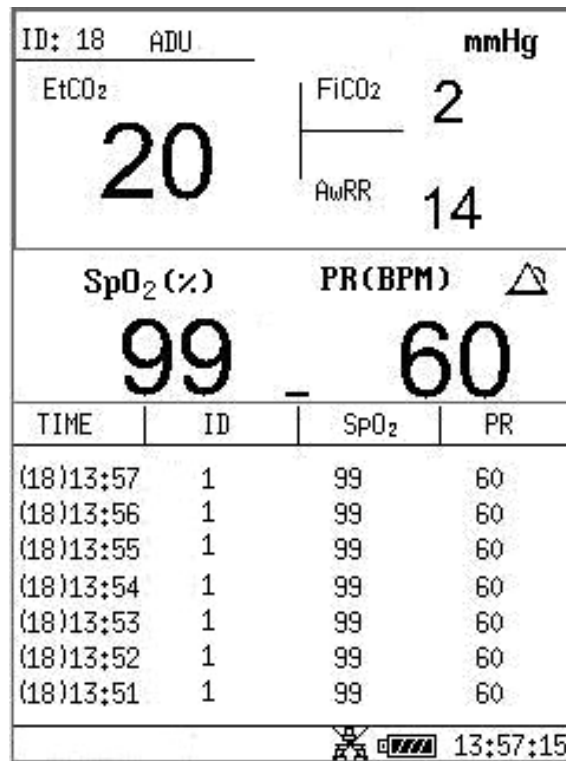

Figure 4-7 SpO<sub>2</sub> Trend Table

- **PARAMETER TAB:** to display parameters trend list of SpO<sub>2</sub> and CO<sub>2</sub> in this area;

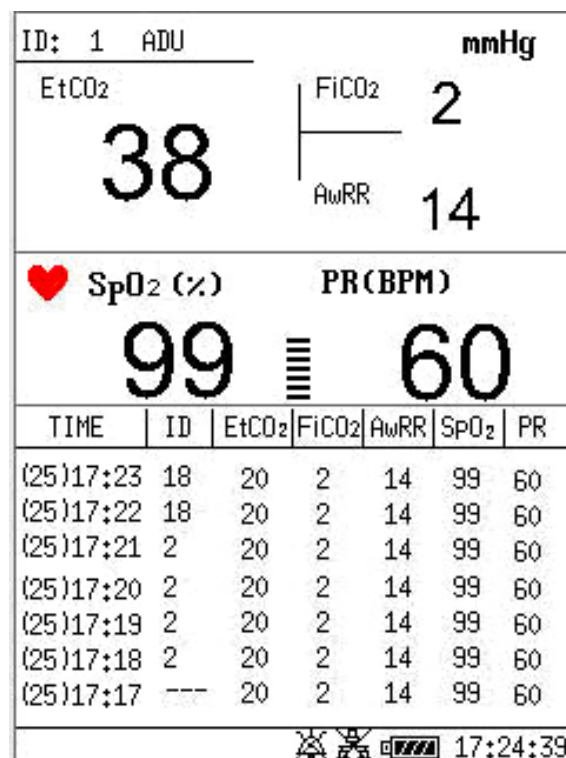

Figure 4-8 Parameter Table

- **ALARM LIST:** to display alarm trend list.

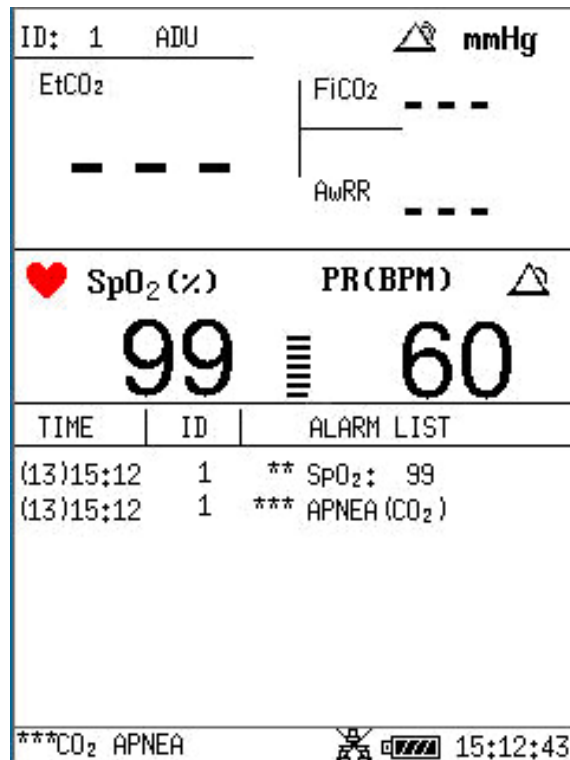

Figure 4-9 Alarm List

- **TREND GRAPH:** select this item to display the trend graph:

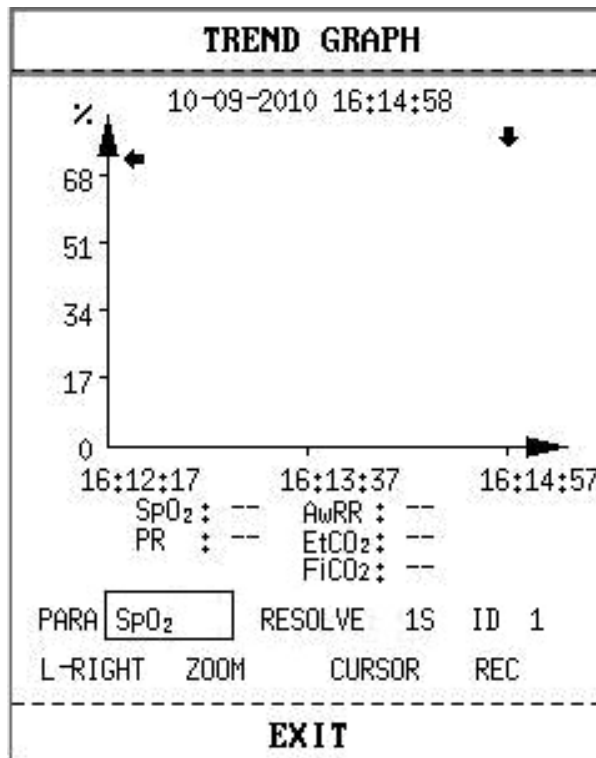

Figure 4-10 Trend Graph

Press **TREND/WAVEFORM** to change the trend list or trend graph to waveform display. The waveform displays as shown in the following figure:

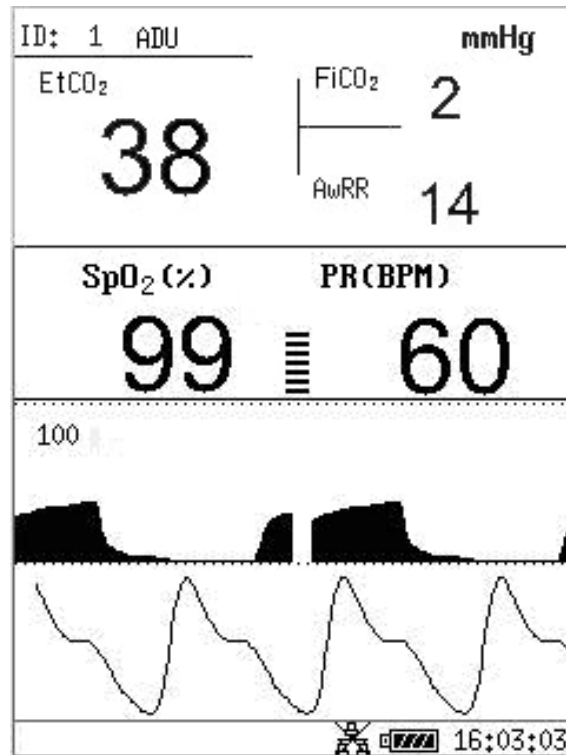

Figure 4-11 Waveform Display

## 4.5 Deleting Data

If you press the button  when a trend list or an alarm list is displayed onscreen, the following menu will pop up:

Figure 4-12 Delete Data

**DELETE ID:** Entirely delete the trend and alarm data of the current monitored patient.

**DELETE ALL DATA:** Entirely delete the trend and alarm data of all the monitored patients.

Select **YES** to make the operation effective; select **NO** to cancel the operation.

## 4.6 Version

Select **VERSION** in **SYSTEM MENU** to see the version of the monitor or the module details.

## 4.7 Time Setup

Select **TIME SETUP** in **SYSTEM MENU** menu to access the submenu of **TIME SETUP** as shown below. System time is in format of **Y-M-D**, **M-D-Y**, **D-M-Y**. users can set the year, month, day, hour, minute and second. Pick the item you want to modify and confirm it using **OK**. Select **EXIT** item to save the setup and return to the previous menu. If you want to exit the menu without saving it, press the **MENU** button on front panel.

<b>TIME SETUP</b>			
FORMATE	<input type="text" value="Y-M-D"/>		
YEAR	2008	HOUR	9
MONTH	2	MINUTE	14
DAY	29	SECOND	38
<b>EXIT</b>			

Figure 4-13 Time Setup



## 4.8 CO<sub>2</sub> Setup

Select **CO<sub>2</sub> SETUP** in **SYSTEM MENU** menu to open the following menu:

CO <sub>2</sub> SETUP	
WAVE SCALE	LOW
BARO PRESS	760mmHg
O <sub>2</sub> COMPENS	16%
ANE AGENT	0.0%
BALAN GAS	ROOM AIR
APNEA ALM	20S
ZERO CAL	
EXIT	

Figure 4-14 CO<sub>2</sub> Setup

- **WAVE SCALE:** Adjust full scale size of CO<sub>2</sub> waveform display area with **LOW** or **HIGH** selectable. The default value is **LOW**.
- **BARO PRESS:** Set the barometric pressure value.
- **O<sub>2</sub> COMPENS:** Adjust the O<sub>2</sub> compensating concentration as per the selection of the user.
- **ANE AGENT:** Adjust the anesthetic compensating concentration as per the selection of the user.
- **BALAN GAS:** Balance the gas compensating operations.
- **APNEA ALM:** After selecting the alarm time for **APNEA** alarm (having 7 levels, which are **10S, 15S, 20S, 25S, 30S, 35S** and **40S**), the **CO<sub>2</sub> APNEA** information will appear on the screen after the corresponding selected time. The alarm level is **HIGH**.
- **ZERO CAL:** Perform CO<sub>2</sub> model zero calibration.

### WARNING

Connect the CO<sub>2</sub> module to the monitor, press the **CO<sub>2</sub> START/STOP** button, then select the **ZERO CAL** in menu to start the zero calibration.

See the function details of the items in Chapter9 **CO<sub>2</sub> Measuring**.

## 4.9 Alarm Setup

Press **ALARM SETUP** in **SYSTEM MENU** menu to open **ALARM SETUP** submenu as shown below, in which the user may turn on or off alarm or set the upper alarm limit or lower alarm limit.

If **ALM** is **ON**, by pressing the **SILENCE** button on the front panel, you can silence the audible alarm or turn off the audio system. If the **ALM** is **OFF** in this submenu, the monitor will not give an alarm when alarm condition is active.

By configuring **ALM REC**, you may also enable the automatic outputting of the alarm information in case of any physiological alarm. For more information, please refer to *5.1.3 Alarm Setup*.

ALARM SETUP			
	ALM	ALM HI	ALM LO
EtCO <sub>2</sub>	<input type="checkbox"/> ON	<input type="text" value="100"/>	<input type="text" value="8"/>
FiCO <sub>2</sub>		<input type="text" value="2"/>	
AwRR		<input type="text" value="20"/>	<input type="text" value="8"/>
SpO <sub>2</sub>	<input type="checkbox"/> ON	<input type="text" value="100"/>	<input type="text" value="90"/>
PR		<input type="text" value="120"/>	<input type="text" value="50"/>
ALM REC		<input type="checkbox"/> OFF	
ALM REC TIME		<input type="text" value="8s"/>	
<input type="button" value="EXIT"/>			

Figure 4-15 Alarm Setup

### **WARNING**

If user set **ALM** to **OFF**, the monitor will not give alarm prompt when alarm condition is active, users should use this function cautiously.

## 4.10 Maintenance

Select **SYSTEM MENU > MAINTAIN** to open **ENTER MAINTAIN PASSWORD** dialog box as shown below, in which you can enter password and then customize maintenance settings. Factory maintenance function is only available for the service engineers of EDAN or representative authorized by EDAN.

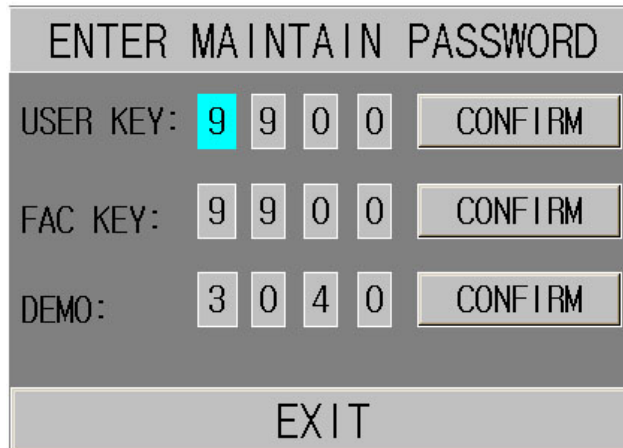

ENTER MAINTAIN PASSWORD					
USER KEY:	9	9	0	0	CONFIRM
FAC KEY:	9	9	0	0	CONFIRM
DEMO:	3	0	4	0	CONFIRM
EXIT					

Figure 4-16 Enter Maintain Password

### User Maintain

Input the password **9981** in the **USER KEY** box and press **OK** button, the **USER MAINTAIN** menu will pop up, in which you can set the following items.



USER MAINTAIN	
BED No.	1
LANGUAGE	ENGLISH
NURSE CALL	ON
SERVER IP	202 114 4 119
SERVER PORT	AUTO
PRES UNIT	mmHg
SpO <sub>2</sub> SETUP	
COLOR SELECT	ALARM SETUP
EXIT	

Figure 4-17 User Maintain

**BED No.:** set the bedside number to a value between 1 and 64.

**LANGUAGE:** set the displayed language.

**NOTE:**

Users should restart the monitor after changing the language.

**NURSE CALL:** turn on or off the nurse call. When the parameter alarm condition is active, the monitor gives 3s nurse call alarm prompt; if the audio alarm or the audio system is off, the monitor can also give the nurse call alarm in abnormal condition.

Normally open relay contacts between pin7 and pin8 of RJ45 connector. Contacts closed when any alarm is audible.

**SERVER IP:** The default server IP is 202.114.4.119; it can be changed by the user according to the IP of PC installed with MFM-CMS of EDAN.

**SERVER PORT:** set server port.

**PRES UNIT:** Set the pressure unit to **mmHg**, **kPa** or **%**.

**SpO<sub>2</sub> SETUP:**

Access **SpO<sub>2</sub> SETUP** and you can see the menu as follows:



Figure 4-18 SpO<sub>2</sub> Setup

◆ **SpO<sub>2</sub> ALARM LEV**

You can configure the alarm level for **SpO<sub>2</sub> SENSOR OFF** to **HIGH** or **LOW**.

◆ **SENSITIVITY**

The SpO<sub>2</sub> reading is the average of data collected within a specific time. You can set **Sensitivity** to **HIGH**, **MED** or **LOW** via the menu. The higher the sensitivity is, the quicker the pulse oximeter responds to the changes in the patient's oxygen saturation level. Contrarily, the lower the sensitivity is, the slower the pulse oximeter responds to the changes in the patient's oxygen saturation level, but the measurement accuracy will be improved. When a critical patient is monitored, selecting high sensitivity will help to understand the patient's state.

**COLOR SELECT:** set the displaying color of waveforms:

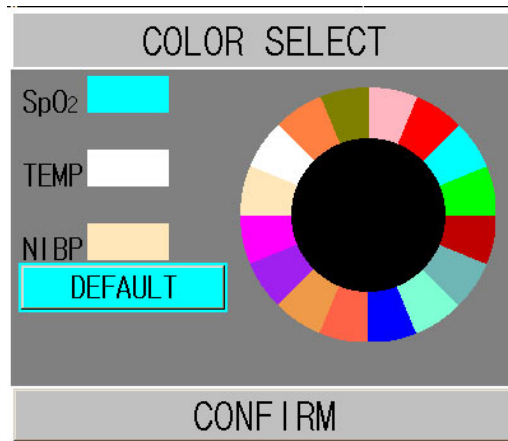

Figure 4-19 Select Color

**ALARM SETUP:**

- ◆ **ALARM NUTE:** Set the duration of silencing the audible alarm to **60s**, **120s** or **180s**.
- ◆ **ALARM SILENCE**

You can set this item to **ON** or **OFF**. If the item is **ON**, you can turn off the audio system by pressing the **SILENCE** button on the front panel for more than 2s. In this case, all sounds including the alarm sound, key sound and sphygmoc sound coming from the monitor will be mute. If the item is **OFF**, the function mentioned above is unavailable.

**EXIT:** exit the menu.

**Factory Maintain**

Factory maintenance function is only available for the service engineers of EDAN or representative authorized by EDAN.

**4.11 Data Storing**

The monitor can support the USB storage for the Data Store function. Enter the menu by **SYSTEM MENU > DATA STORE** to set the data storing function. You can set the storing interval, browse data, search data, and delete all the data or single item data.

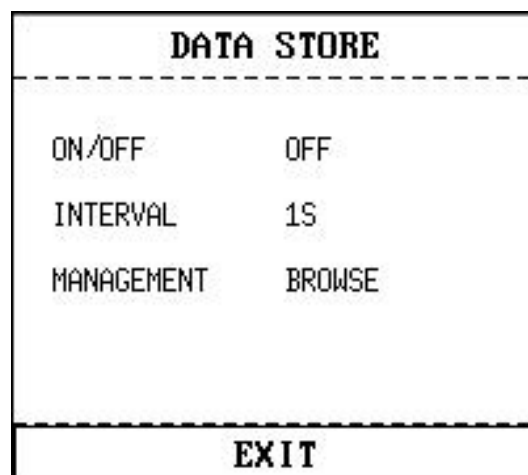

Figure 4-20 Data Store

- **ON/OFF**: set the Data Store function to **ON** or **OFF**.

### WARNING

- 1 If you set this item to **ON**, after restarting the monitor, this item will resume **OFF** automatically.
- 2 If you want to stop the data storing function, you should set this item to **OFF** before unplugging the USB disk.
- 3 Do not unplug the USB storage when storing data. If the damaged data caused by unplugging the USB storage during data storing can not be deleted on the monitor, the user can delete them on the PC.

- **INTERVAL**: set the storing interval by this item, it can be set to **1S, 5S, 10S, 30S, 1MIN** or **5MIN**.
- **MANAGEMENT**: select **BROWSE** to browse data stored before.

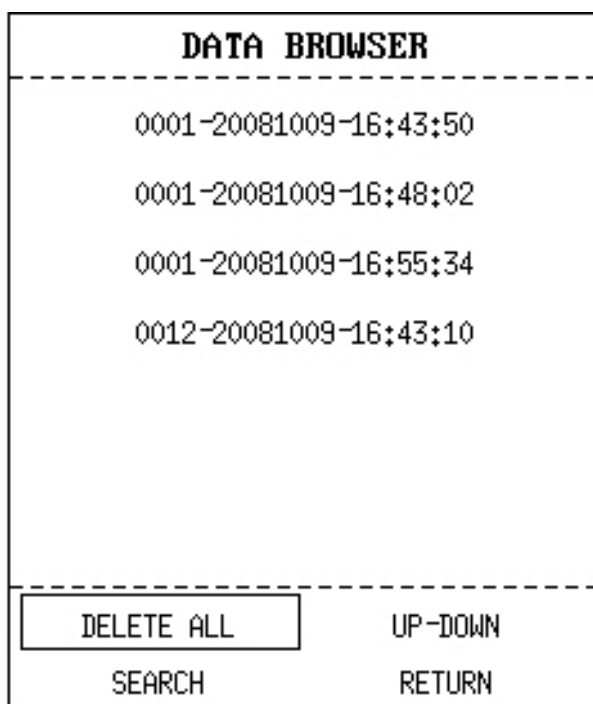

Figure 4-21 Data Browser

- **DELETE ALL**: select this item to delete all the data stored before. The following dialog box displays:

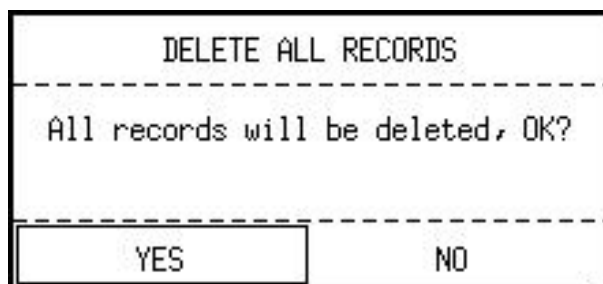

Figure 4-22 Data Browser

Select **YES** to delete all the data.

— **UP-DOWN**: select this item, then turn the page by pressing the **UP** or **DOWN** to browse data.

— **SEARCH**: search data by **PATIENT ID**, **DATE** and **TIME**, then **CONFIRM** it. The following box displays:

SEARCH	
PATIENT ID:	<input type="text" value="0"/> 0 0 0
DATE:	2008 - 10 - 9
TIME:	16 : 58 : 6
CONFIRM	

Figure 4-23 Search

— **RETURN**: select this item to return to the previous menu.

Select the single item data in **DATA BROWSER** menu, press **OK** button to display the following menu:

DELETE
TREND TABLE
TREND GRAPH
ALARM LIST
RETURN

Figure 4-24 Menu

The user can select to browse **TREND TABLE**, **TREND GRAPH** or **ALARM LIST** of SpO<sub>2</sub> or CO<sub>2</sub>. For example, select **TREND TABLE** to display the following screen:

TREND TABLE		
TIME	SpO <sub>2</sub> %	PR BPM
(09)16:57	99	60
(09)16:56	---	---
(09)16:55	---	---
(09)16:54	---	---
(09)16:53	---	---
(09)16:52	---	---
(09)16:51	---	---
(09)16:50	---	---
(09)16:49	---	---
(09)16:48	---	---
(09)16:47	---	---
(09)16:46	---	---

↓

RESOLUTION  UP-DOWN L-RIGHT

EXIT

Figure 4-25 Trend Table

User can select **DELETE** to delete the single item data; or select the **RETURN** to return to the previous menu.

**NOTE:**

- 1 Only the trend graph of SpO<sub>2</sub> can be reviewed in this menu.
- 2 The data which is being stored can not be browsed in real time. Before searching data, you should turn off the **Data Store** function at first.

## 4.12 Sleep Mode

### Entering Sleep Mode

Select **SYSTEM MENU >SYSTEM SETUP >STANDBY** and configure the item to **ON**. Then you will see the following dialog box after pressing the switch for less than 1s:

ENTER SLEEP MODE	
Enter sleep mode,yes?	
<input type="text" value="YES"/>	<input type="text" value="NO"/>

Figure 4-26 Enter Sleep Mode

Select **YES** to enter the Sleep mode.



**NOTE:**

When the **SYSTEM SETUP > STANDBY** is **OFF**, or the monitor is in **DEMO** mode, or there is any inputting signal, pressing the **ON/OFF** button can not make the monitor enter the sleep mode.

**Quitting Sleep Mode**

In the sleep mode, if a new signal occurs or you press any button on the front panel, the monitor will enter the working mode.

**NOTE:**

- 1 If the following situation occurs, monitor will return to normal monitoring mode automatically: the monitor receives physiological signal of SpO<sub>2</sub>, and lasts for 5s; if the monitor is powered by battery, when the battery electric energy is low, it will enter normal monitoring mode, and indicates low battery alarm.
- 2 In DEMO mode, the monitor can not enter Sleep mode.

## Chapter 5 Alarm

This chapter gives general information about the alarm and measures to be taken accordingly. Alarm setup is provided in respective parameter setup sections.

### **WARNING**

A potential hazard can exist if different alarm presets are used for the same or similar equipment in any single area, e.g. an intensive care unit or cardiac operating room.

## 5.1 Alarm Modes

### 5.1.1 Alarm Level

Each alarm, either technical or physiological, has its own level. For alarm of higher level, when the alarm condition is active, the system will give prompt in various ways. Alarms in the monitor are divided into three levels: High, Medium and Low.

High-level alarm indicates the patient's life is in danger or the monitor has serious problem in technical respect. It is the most serious alarm.

Medium-level alarm means serious warning.

Low-level alarm is a general warning.

Alarms are classified into physiological alarm and technical alarm. Physiological alarms refer to those alarms triggered by patient's physiological situation which could be considered dangerous to his or her life. Technical alarm refer to system failure which can make certain monitoring process technically impossible or make monitoring result unbelievable. Technical alarm is also called System Error Message.

The monitor has pre-set the alarm levels for the parameters.

Alarm level of the System Error Message (technical alarm) is pre-set in the system.

The alarm levels for technical alarms, general alarms and some physiological alarms are pre-set by the system and cannot be changed by the user in most of the cases. But you can alter the alarm level for **SpO<sub>2</sub> SENSOR OFF**. For more information, please refer to *SpO<sub>2</sub> SETUP* in *4.10 Maintain*.

### 5.1.2 Alarm Modes

When alarm occurs, the monitor can raise the user's attention in at least three ways, which are audio prompt, visual prompt and description.

Audio and visual prompt is given by LCD display device, the speaker on the display device and the alarm indicator. Physiological alarm, Technical Alarm or description is displayed in Information area at the bottom of the screen.

**NOTE:**



The concrete presentation of each alarm prompt is related to the alarm level.

**Screen Display**

When the measured parameter exceeds its alarm limits and triggers a physiological alarm, the monitor will give alarm prompt on the screen indicating the occurrence of alarm.

The description will display in Information area, such as “\*\* NS TOO HIGH”, and  displays beside the parameter to indicate the low-medium level alarm.

Technical alarm will not prompts “\*” signal.

Alarm Level	Visual Prompt
High	1:  displays in Parameter area 2: *** displays beside the parameter (Physiological alarm only)
Medium	1:  displays in Parameter area 2: ** displays beside the parameter (Physiological alarm only)
Low	1:  displays in Parameter area 2: * displays beside the parameter (Physiological alarm only)

The waveform screens with alarm are displayed as follows:

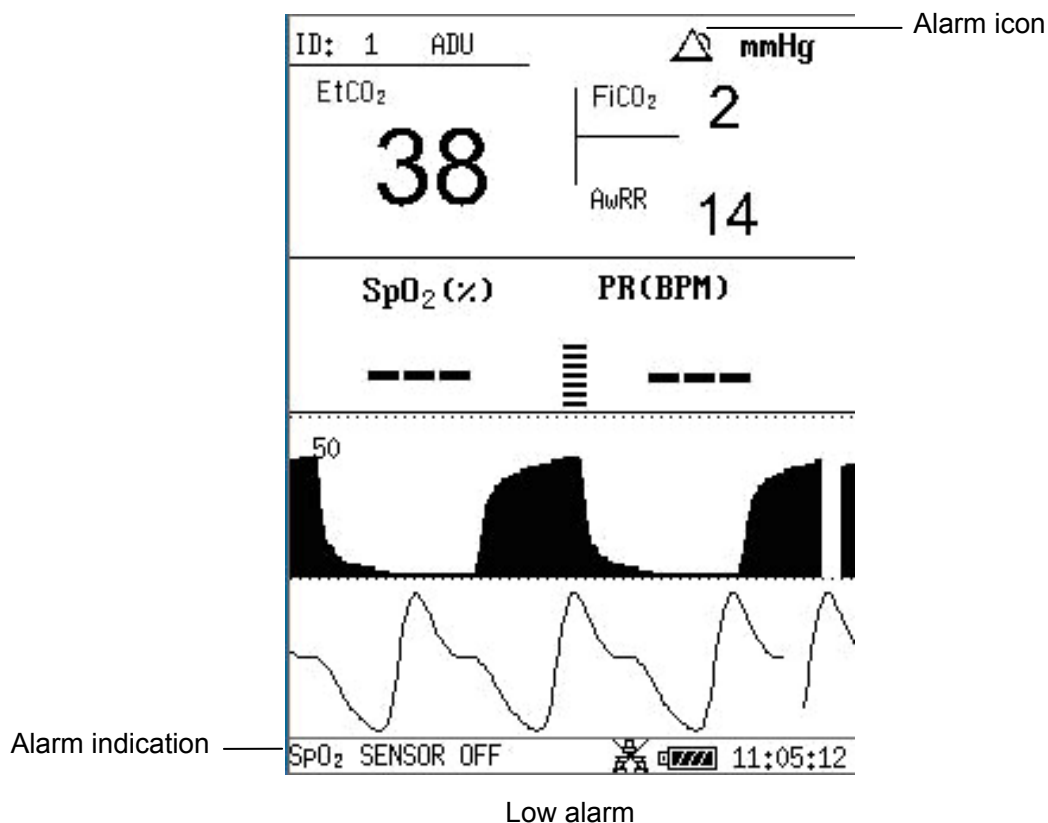

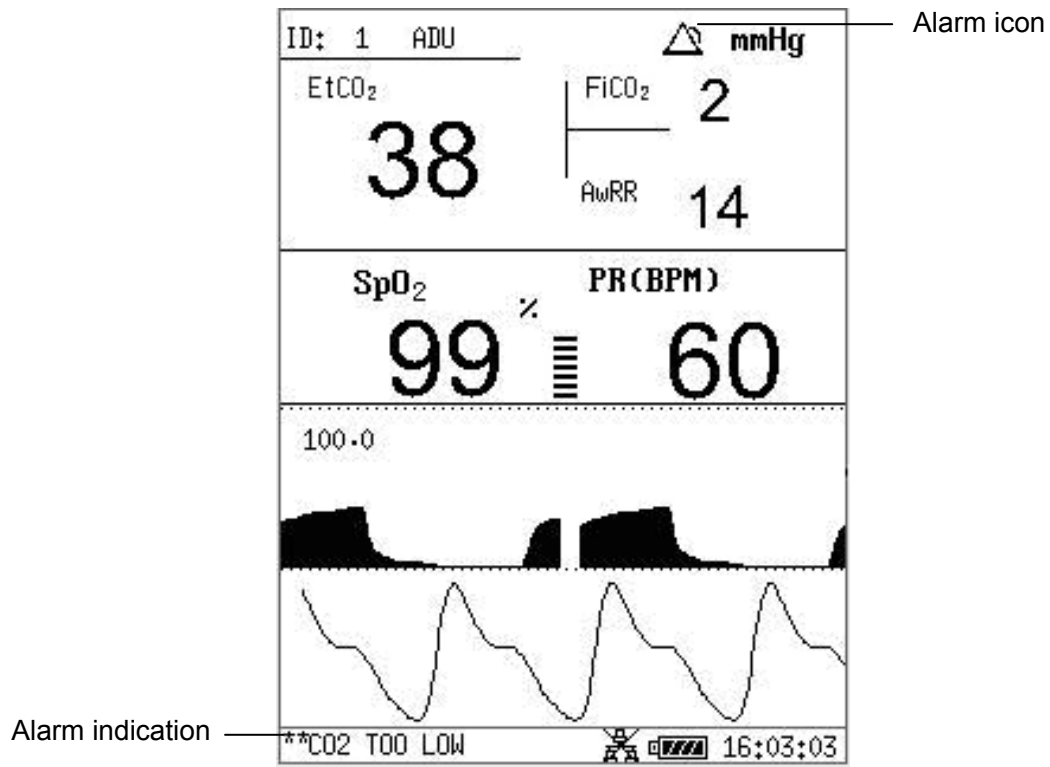

Medium alarm

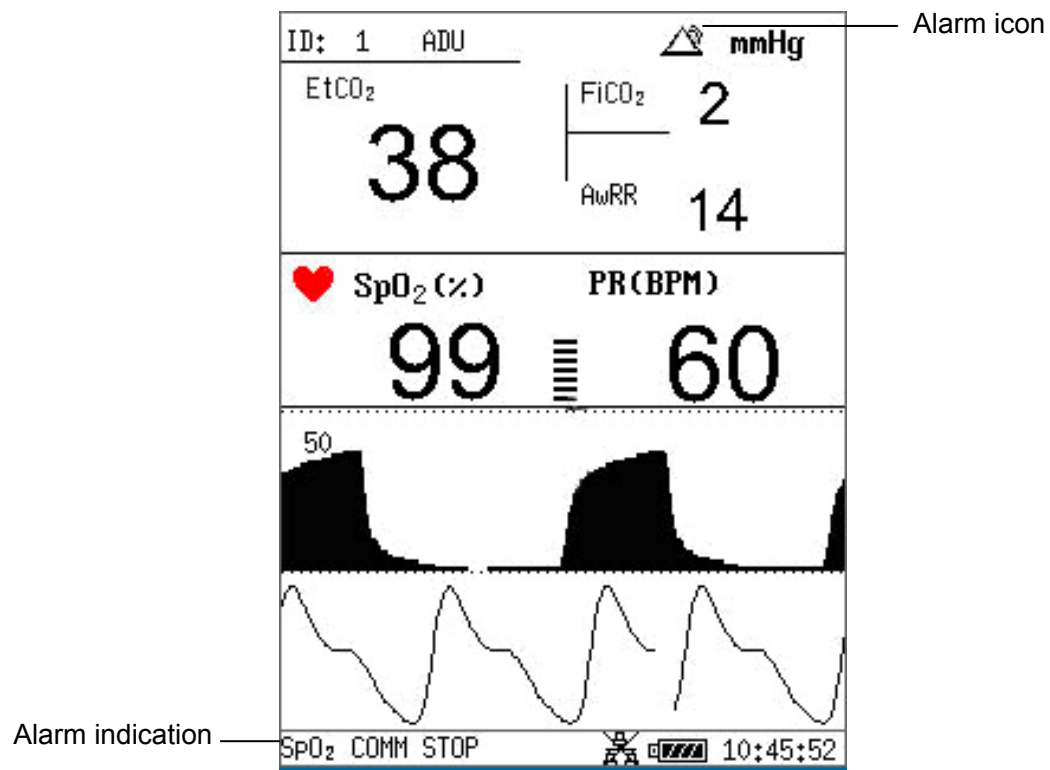

High alarm

Figure 5-1 Alarm Displays on Screen with Waveform

The physiological alarms are displayed in alarm list as follows:

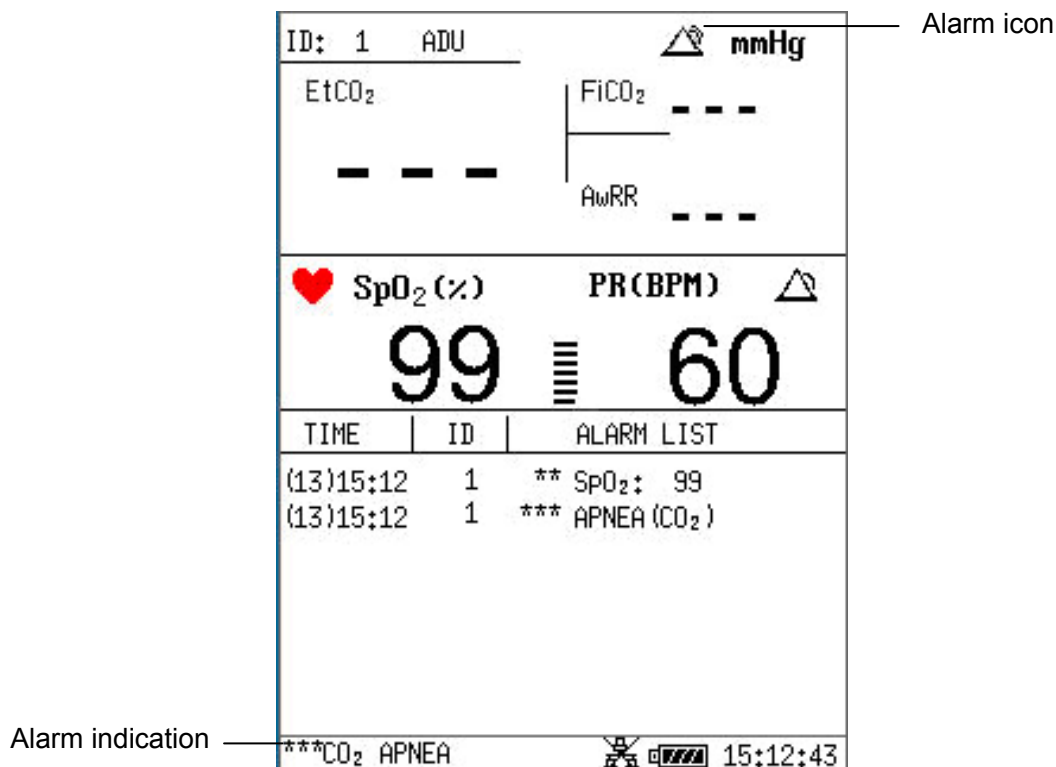

Figure 5-2 Alarm Displays on Screen with Alarm List

### Lamp light

The high/medium/low-level alarms are indicated by the system in following different visual ways:

Alarm Level	Visual Prompt
High	Alarm indicator flashes in red with high frequency.
Medium	Alarm indicator flashes in orange with low frequency.
Low	Alarm indicator lights on in orange.

### Alarm Sound

The high/medium/low-level alarms are indicated by the system in following different audio ways:

Alarm Level	Audio Prompt
High	Mode is “beep-beep-beep-----beep-beep, beep-beep-beep---beep-beep”, which is triggered once every 5 seconds.
Medium	Mode is “beep-beep-beep”, which is triggered once every 20 seconds.
Low	Mode is “beep-”, which is triggered once every 25 seconds.

The sound pressure range for audible alarm signals is from 45 dB to 85 dB.

**NOTE:**

- 1 The monitor does not have alarm condition delay or alarm signal generation delay.
- 2 When alarms of different levels occur at the same time, the monitor prompts the one of the highest level.
- 3 If the monitor is powered off and then turned on, the alarm setup can resume to the setup which is set before the power-off.

### 5.1.3 Alarm Setup

#### Setting alarm in the ALARM SETUP menu

Select the **ALARM SETUP** in the **SYSTEM MENU** to open the submenu as shown below. In this menu, the user may turn **ON** or **OFF** the alarm, and set the upper alarm limit and lower alarm limit for each parameter by **ALM HI** or **ALM LO**.

ALARM SETUP			
	ALM	ALM HI	ALM LO
EtCO <sub>2</sub>	ON	100	8
FiCO <sub>2</sub>		2	
AwRR		20	8
SpO <sub>2</sub>	ON	100	90
PR		120	50
ALM REC		OFF	
ALM REC TIME		8s	
EXIT			

Figure 5-3 Alarm Setup

#### Alarm setup of each parameter

In the **ALARM SETUP** menu, select the item to set the alarm limit for **EtCO<sub>2</sub>**, **FiCO<sub>2</sub>**, **AWRR**, **SpO<sub>2</sub>** and **PR**.

For example: Method to set alarm limit for **SpO<sub>2</sub> ALM**:

Step 1: Set the **SpO<sub>2</sub> ALM** to **ON**;

Step 2: Select the **ALM HI** (higher limit of **SpO<sub>2</sub> ALM**), **ALM LO** (lower limit of **SpO<sub>2</sub> ALM**).

You can use the **UP/DOWN** button and **OK** button to make the set the value.

The method for setting the alarm limit of other parameters is the same as **SpO<sub>2</sub> ALM**.

#### ALM REC and ALM REC TIME

By configuring **ALM REC**, the function of automatically outputting the alarm information in

case of any physiological alarm can be enabled or disabled. If the item is **ON**, the monitor will automatically print out the alarm information once any physiological alarm happens. If the item is **OFF**, the monitor will not automatically output the alarm information.

Additionally, if **ALM REC** is set to **ON**, you can also adjust the recording time of the alarm waveform to be outputted by setting **ALM REC TIME**. Available options are **8s**, **16s** and **32s**.

## 5.2 Alarm Cause

Alarm occurs when:

1. Physiological alarm is evoked;
2. Alarm for error of the system (technical alarm) is evoked.

### ■ A. Conditions that activate the parameter alarms:

The measurement value exceeds the alarm limit and the alarm is set to **ON**. Alarms will not activate if the alarm is set to **OFF**.

### ■ B. Conditions that activate the system alarms (technical alarm):

Upon the system error, the monitor prompts alarm immediately.

## 5.3 Silence

The user can press **Silence** button on front panel to stop audio alarm or turn off the audio system.

### Alarm silenced icon



Press the **SILENCE** button on the front panel for less than 2s, and the audible alarm is mute. The alarm silenced icon displays. Pressing **SILENCE** button again can resume the audible alarm.

### Audio system off icon



Press the **Silence** button for more than 2s, the audio system is turned off, including the audio alarm, key volume and the pulse tone. Then press **Silence** button again can resume the audio system.

## 5.4 Parameter Alarm

### **WARNING**

- 1 Prior to monitoring, make sure that the alarm limit settings are appropriate for your patient.
- 2 Setting alarm limits to extreme values may cause the alarm system to become ineffective.

The setup for parameter alarms is in their menus. In the menu for a specific parameter, you can check and set the alarm limit, alarm status. The setup is isolated from each other.

When a parameter alarm is off, a symbol  displays near the parameter. If the alarms are turned off individually, they must be turned on individually.

For the parameters whose alarm is set to **ON**, the alarm will be triggered when at least one of them exceeds alarm limit. The following actions take place:

1. Alarm message displays on the screen as described in alarm mode;
2. The monitor beeps in its corresponding alarm class and volume;
3. Alarm lamp flashes.

## 5.5 When an Alarm Occurs

### **NOTE:**

When an alarm occurs, you should always check the patient's condition first.

The alarm message appears at the top of the screen on the right side. It is needed to identify the alarm and act appropriately, according to the cause of the alarm.

1. Check the patient's condition.
2. Identify the cause of the alarm.
3. Identify which parameter is alarming or which alarm is happening.
4. When cause of alarm has been over, check that the alarm is working properly.

You will find the alarm messages for the individual parameter in their appropriate parameter chapters of this manual.

## 5.6 Testing Alarms

When you switch the monitor on, a selftest is started. You must check that the alarm indicator lights and that you hear a single tone. This indicates that the visible and audible alarm indicators are functioning correctly. For further testing of individual measurement alarms, perform the measurement on yourself or use a simulator. Adjust alarm limits and check that appropriate alarm behavior is observed.



## Chapter 6 Trend and Recording

The monitor provides 72-hour trend data of all parameters (**EtCO<sub>2</sub>**, **FiCO<sub>2</sub>**, **AwRR**, **SpO<sub>2</sub>** and **PR**), 5-hour CO<sub>2</sub> waveform, 5-hour SpO<sub>2</sub> waveform and 800 alarm events.

In **SELECTION** submenu, the user can set the displayed table, then the trend table or alarm list which can be printed out via **RECORD** button.

### 6.1 General Information on Recording

A thermal dot matrices recorder with 48mm wide printout paper is used for the monitor.

#### Performance of the Recorder:

- Trend list is printed out at the rate of 25 mm/s.
- English printout.

Set the displayed content via **SELECTION** in **SYSTEM MENU** (Refer to 4.4 **Selection**), then print it via **RECORD** button.

If you need to print the former data, you can shift the displayed table by **UP/DOWN** button, and then the former data can be displayed and printed out.

The real-time waveform of 8s can be printed out.

#### NOTE:

- 1 You can press the **RECORD** button on the control panel to stop the current recording process.
- 2 It is suggested that user should not use the recorder when the low battery displays, or the monitor may be turned off automatically.

### 6.2 Recorder Operations

#### Record Paper Requirement

Only standard thermosensitive record paper can be used, otherwise the recorder may not function, the recording quality may be poor, and the thermosensitive print head may be damaged.

#### Proper Operation

- When the recorder is working, the record paper goes out steadily. Do not pull the paper outward with force, otherwise the recorder may be damaged.
- Do not operate the recorder without record paper.

#### Paper Out

When **RECORDER OUT OF PAPER** alarm is displayed, the recorder can not start. Please insert record paper properly.

## Inserting Paper

- Pull outwards the upper arc part of the recorder casing to release the casing.
- Insert a new roll of paper into the paper cassette, printing side facing upwards.
- Ensure proper position and tidy margin.
- Pull about 2cm of the paper out, and then close the recorder casing.

### **NOTE:**

Be careful when inserting paper. Avoid damaging the thermo-sensitive print head. Unless when inserting paper or shooting troubles, do not leave the recorder catch open.

## Removing Paper Jam

When the recorder functions or sounds improperly, you should open the recorder casing to check for a paper jam. Removing the paper jam in the following way:

- Cut the record paper from the feeding edge.
- Open the recorder casing.
- Re-insert the paper.

## Chapter 7 Maintenance/Cleaning

### 7.1 System Check

Before using the monitor, do the following:

- Check if there is any mechanical damage;
- Check if all the outer cables, inserted modules and accessories are in good condition;
- Check all the functions of the monitor to make sure that the monitor is in good condition.

If you find any damage on the monitor, stop using the monitor on patient, and contact the biomedical engineer of the hospital or EDAN immediately.

The overall check of the monitor, including the safety check, should be performed only by qualified personnel once every 6 to 12 months, and each time after fixing up.

All the checks that need you to open the monitor should be performed by qualified customer service technician. The safety and maintenance check can be conducted by persons from this company. You can obtain the material about the customer service contract from the local company's office.

---

---

#### **WARNING**

- 1 If the hospital or agency that is responding to using the monitor does not follow a satisfactory maintenance schedule, the monitor may become invalid, and the human health may be endangered.
  - 2 Replace batteries according to the instruction of our service engineer.
- 
- 

#### **NOTE:**

To prolong the life of rechargeable battery, charging it once every month at least is recommended, and it must be done after the electric energy runs out.

### 7.2 General Cleaning

---

---

#### **WARNING**

Before cleaning the monitor or the sensor, make sure that the equipment is switched off and disconnected from the power line.

---

---

---

---

#### **CAUTION**

Please pay special attention to the following items:

- 1 Most cleaning agents must be diluted before use. Follow the manufacturer's directions carefully to avoid damaging the monitor.
  - 2 Do not use the grinding material, such as steel, wool etc.
  - 3 Do not let the cleaning agent enter into the chassis of the system.
  - 4 Do not leave the cleaning agents at any part of the equipment.
- 
-

The monitor, cables and accessories must be kept dust-free.

Regular cleaning of the monitor shell and the screen is strongly recommended. Use only non-caustic detergents such as soap and warm water (40°C/104°F maximum) to clean the monitor shell. Do not use strong solvents such as acetone or trichloroethylene.

Take extra care when cleaning the screen of the monitor because it is more sensitive to rough cleaning methods than the housing. Do not permit any liquid to enter the monitor case and avoid pouring it on the monitor while cleaning. Do not allow water or cleaning solution to enter the measurement connectors. Wipe around, except connector sockets.

Recommended cleaning agents are:

Tenside (dishwasher detergents)	Edisonite Schnellreiniger, Alconox
Ammonias	Dilution of Ammonia <3%, Window cleaner
Alcohol	Ethanol 70%, Isopropanol 70%, Window cleaner
Sodium Hypochlorite	1% ~ 10%

To clean the SpO<sub>2</sub> sensor, please refer to the instruction delivered with the accessory.

**NOTE:**

- 1 The diluted sodium hypochlorite from 500ppm (1:100 diluted bleaching agent) to 5000ppm (1:10 bleaching agents) is very effective. The concentration of the diluted sodium hypochlorite depends on how many organisms (blood, mucus) on the surface of the chassis to be cleaned.
- 2 The monitor and sensor surface can be cleaned with hospital-grade ethanol and dried in air or with crisp and clean cloth.
- 3 This company has no responsibility for the effectiveness of controlling infectious disease using these chemical agents. Please contact infectious disease experts in your hospital for details.

## 7.3 Sterilization

Do not sterilize the monitor or the accessories, unless this is necessary according to your hospital regulation.

## 7.4 Disinfection

To avoid extended damage to the equipment, disinfection is only recommended when stipulated as necessary in the Hospital Maintenance Schedule. Disinfection facilities should be cleaned first.

Use a soft cloth saturated with disinfectant to disinfect the monitor, the reusable CO<sub>2</sub> sensor and SpO<sub>2</sub> sensor.

Recommended types of disinfecting agents are:

- Alcohol: Alcohol Ethanol up to 70%, 1- and 2-Propanol up to 70%
- Aldehyde: Glutaraldehyde up to 3.6%

---

**WARNING**

---

Please do not mix disinfecting solutions (such as bleach and ammonia) as hazardous gases may result.

---

---

**CAUTION**

---

- 1 Disinfect the product as determined by your hospital's policy, to avoid long term damage to the product.
  - 2 Follow the manufacturer's instruction to dilute the solution, or adopt the lowest effective concentration.
  - 3 Do not let liquid enter the monitor.
  - 4 No part of this monitor can be subjected to immersion in liquid.
  - 5 Do not pour liquid onto the monitor during sterilization.
  - 6 Use a moistened cloth to wipe up any agent remained on the monitor.
  - 7 Do not use gas, such as EtO or formaldehyde to disinfect the monitor.
- 

## 7.5 Replacement of Fuse

Unscrew the fuse cap anticlockwise, replace the fuse (protector tube) and screw down the fuse cap clockwise. Fuse size:  $\Phi 5 \times 20$ , Rated value: T1.6AL/250V.

**NOTE:**

Switch off the power of the monitor before examining the fuse.

## 7.6 Cleaning Battery and Battery Compartment Cover

Use only non-caustic detergents such as soap and warm water (40°C/104°F maximum) to clean the battery. Do not use strong solvent to clean battery, and do not dip the battery in liquid.

## Chapter 8 SpO<sub>2</sub> Monitoring

### 8.1 What is SpO<sub>2</sub> Monitoring

The monitor uses oximetry to measure functional oxygen saturation in the blood. SpO<sub>2</sub> Plethysmogram measurement is employed to determine the oxygen saturation of hemoglobin in the arterial blood. If, for example, 97% hemoglobin molecules in the red blood cells of the arterial blood combine with oxygen, then the blood has an SpO<sub>2</sub> oxygen saturation of 97%. The SpO<sub>2</sub> numeric on the monitor will read 97%. The SpO<sub>2</sub> numeric shows the percentage of hemoglobin molecules which have combined with oxygen molecules to form oxyhemoglobin. The SpO<sub>2</sub>/PLETH parameter can also provide a pulse rate signal and a plethysmogram wave.

#### How the SpO<sub>2</sub>/PLETH Parameter Works

- Arterial oxygen saturation is measured by a method called pulse oximetry. It is a continuous, non-invasive method based on the different absorption spectra of reduced hemoglobin and oxyhemoglobin. It measures how much light, sent from light sources on one side of the sensor, is transmitted through patient tissue (such as a finger or an ear), to a receiver on the other side.
- The amount of light transmitted depends on many factors, most of which are constant. However, one of these factors, the blood flow in the arteries, varies with time, because it is pulsating. By measuring the light absorption during a pulsation, it is possible to derive the oxygen saturation of the arterial blood. Detecting the pulsation gives a PLETH waveform and pulse rate signal.
- The SpO<sub>2</sub> value and the PLETH waveform can be displayed on the main interface.
- The sensor contains LEDs that emit red light at a wavelength of approximately 660 nm and infrared light at a wavelength of approximately 900 nm. The power of the sensor LED is less than 15mW.

---

#### **WARNING**

Pulse oximetry can overestimate the SpO<sub>2</sub> value in the presence of Hb-CO, Met-Hb or dye dilution chemicals.

---

#### SpO<sub>2</sub>/Pulse Monitoring

---

#### **WARNING**

- 1 ES (Electrosurgery) equipment wire and SpO<sub>2</sub> cable must not be tangled up.
  - 2 Do not put the sensor on extremities with arterial catheter or venous syringe.
- 

#### **NOTE:**

Do not perform SpO<sub>2</sub> measuring and blood pressure measuring in a same arm at a time, because obstruction of blood flow during blood pressure measuring may adversely affect the reading of SpO<sub>2</sub> value.

## 8.2 Precautions During SpO<sub>2</sub>/Pulse Monitoring

### **WARNING**

- 1 Verify sensor cable fault detection before beginning of monitoring phase. Unplug the SpO<sub>2</sub> sensor cable from the socket, the screen will display the error message **SpO<sub>2</sub> SENSOR OFF** and the audible alarm is activated.
- 2 If the SpO<sub>2</sub> sensor can not work properly, please reconnect the sensor or change a new one.
- 3 Do not use the sterile supplied SpO<sub>2</sub> sensors if the packaging or the sensor is damaged and return them to the vendor.
- 4 Prolonged and continuous monitoring may increase the risk of unexpected change of dermal condition such as abnormal sensitivity, rubescence, vesicle, repressive putrescence, and so on. It is especially important to check the sensor placement of neonate and patient of poor perfusion or immature dermogram by light collimation and proper attaching strictly according to changes of the skin. More frequent examinations may be required for different patients.
- 5 Tissue damage may be caused by incorrect application or prolonged measurement duration using the sensor (more than 4 hours). Inspect the sensor periodically according to sensor user manual.
- 6 Neonate SpO<sub>2</sub> sensor can only be used when it requires to, less than 20min at a time.
- 7 The sensor complies with the ISO 10993-1 for biocompatibility.

### **NOTE:**

- 1 Make sure the nail covers the light window;
- 2 The wire should be on the backside of the hand.
- 3 Hand should not be too cold when measuring, and the nail polish should be cleaned before measuring, or the data accuracy may be affected.
- 4 SpO<sub>2</sub> waveform is not proportional to the pulse volume.

## 8.3 Monitoring Procedure

### **SpO<sub>2</sub> Plethysmogram Measurement**

1. Switch on the monitor.
2. Attach the sensor to the appropriate site of the patient finger.
3. Plug the connector of the sensor extension cable into the SpO<sub>2</sub> socket on the SpO<sub>2</sub> module.

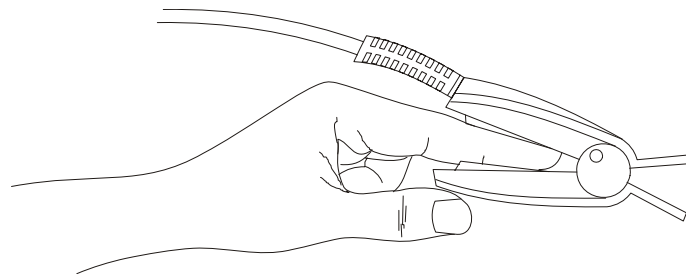

Figure 8-1 Mounting of the Sensor

## 8.4 Limitations for Measurement

In operation, the accuracy of oximetry readings can be affected by:

- High-frequency electrical noise, including noise created by the host system, or noise from external sources, such as electrosurgical apparatus, which is admitted by the host system.
- Do not use monitor and oximetry sensors during magnetic resonance imaging (MRI) scanning. Induced current could potentially cause burns.
- Intravenous dye
- Excessive patient movement
- Outside ray radiation
- Improper sensor application
- Sensor temperature (maintain between 28°C and 42°C for best operation)
- Placement of the sensor on an extremity that has a blood pressure cuff, arterial catheter, or intravascular line
- Significant concentration of dysfunctional hemoglobin, such as carboxyhemoglobin and methemoglobin
- Low SpO<sub>2</sub>.
- Circular perfusion is not well for test part
- It is recommended to use SpO<sub>2</sub> sensors described in chapter Accessories and Ordering Information.
- The dissipation power is less than 50μW, when the sensor temperature is higher than 41°C, you should shorten the measuring time.

## 8.5 Alarm Setup Menu

Enter **SYSTEM MENU > ALARM SETUP**:

In the menu, the alarm for SpO<sub>2</sub> or PR can be turned **ON** or **OFF**, and the alarm limits can be adjusted. Select **ON** to enable alarm during SpO<sub>2</sub> monitoring; select **OFF** to disable the alarm

function, and a  will be displayed on the screen beside the corresponding parameter.

ALARM SETUP			
	ALM	ALM HI	ALM LO
EtCO <sub>2</sub>	<input type="button" value="ON"/>	<input type="text" value="100"/>	<input type="text" value="8"/>
FiCO <sub>2</sub>		<input type="text" value="2"/>	
AwRR		<input type="text" value="20"/>	<input type="text" value="8"/>
SpO <sub>2</sub>	<input type="button" value="ON"/>	<input type="text" value="100"/>	<input type="text" value="90"/>
PR		<input type="text" value="120"/>	<input type="text" value="50"/>
ALM REC		<input type="button" value="OFF"/>	
ALM REC TIME		<input type="text" value="8s"/>	
<input type="button" value="EXIT"/>			

Figure 8-2 Alarm Setup



**WARNING**

In order to avoid endangering the patient's life, the user should use this function cautiously.

Default SpO<sub>2</sub> alarm limits:

	<b>Max. Upper Limit</b>	<b>Min. Lower Limit</b>	<b>Step</b>
ADU	100	90	1
PED	100	90	1
NEO	95	88	1

Default PR alarm limits:

	<b>Max. Upper Limit</b>	<b>Min. Lower Limit</b>	<b>Step</b>
ADU	120	50	1
PED	160	75	1
NEO	200	100	1

SpO<sub>2</sub>/ PR alarm range:

<b>Parameter</b>	<b>Max. Upper Limit</b>	<b>Min. Lower Limit</b>	<b>Step</b>
SpO <sub>2</sub>	100	0	1
PR	300	30	1

## 8.6 Alarm Description

### SpO<sub>2</sub> Alarm Message

Tables below describe the possible physiological alarms, technical alarms occurring during SpO<sub>2</sub> measurement.

When there is no SpO<sub>2</sub> or PR input, it prompts weak signal.

Physiological alarm:

<b>Message</b>	<b>Cause</b>	<b>Alarm Level</b>
SpO <sub>2</sub> TOO HIGH	SpO <sub>2</sub> measuring value is above upper alarm limit.	Medium
SpO <sub>2</sub> TOO LOW	SpO <sub>2</sub> measuring value is below lower alarm limit.	Medium

PR TOO HIGH	PR measuring value is above upper alarm limit.	Medium
PR TOO LOW	PR measuring value is below lower alarm limit.	Medium
NO PULSE	Sphygmic signal from the measured position is too weak; the monitor does not detect any sphygmic signal.	High

## Technical alarms:

Message	Cause	Alarm Level	What to do
SpO <sub>2</sub> SENSOR OFF	The SpO <sub>2</sub> sensor may be disconnected from the patient.	High/ Low (Configured by the user)	Make sure the sensor is attached to the patient's finger or another appropriate position.
SEARCH PULSE	SpO <sub>2</sub> sensor may be disconnected from the patient or the monitor.	Low	If no pulse information is displayed after 30s passes, check whether the sensor is connected with the patient's finger. If necessary, attach the sensor to another position which might provide better signal.
SpO <sub>2</sub> COMM STOP	SpO <sub>2</sub> module failure or communication failure	High	Stop using measuring function of SpO <sub>2</sub> module; notify biomedical engineer or manufacturer's service staff.
SpO <sub>2</sub> LOW PERFUSION	The measured signals coming from pulse are too weak.	Low	Reconnect the sensor, or choose another measured position. If the problem remains, please notify biomedical engineer or manufacturer's service staff.
NO SpO <sub>2</sub> SENSOR	The SpO <sub>2</sub> sensor is disconnected from the monitor, or the sensor is not connected well to the device.	Low	Reconnect the sensor with the monitor. Make sure the monitor is well connected with the cable.

## 8.7 Maintenance and Cleaning

---

---

### **WARNING**

- 1 Before cleaning the monitor or the sensor, make sure that the equipment is switched off and disconnected from the power line.
  - 2 Do not subject the sensor to autoclaving.
  - 3 Do not immerse the sensor into any liquid.
  - 4 Do not use any sensor or cable that may be damaged or deteriorated.
- 
- 

#### **For cleaning:**

- Use a cotton ball or a soft mull moistened with hospital-grade ethanol to wipe the surface of the sensor, and then dry it with a cloth. This cleaning method can also be applied to the luminotron and receiving unit.
- The cable can be cleaned with 3% hydrogen dioxide, 70% isopropanol, or other active reagent. However, connector of the sensor shall not be subjected to such solution.

To disinfect the SpO<sub>2</sub> sensor, please refer to Chapter7.

## Chapter 9 CO<sub>2</sub> Monitoring

### 9.1 General Information

This chapter offers some relevant data concerning CO<sub>2</sub> monitoring.

Monitor provides SideStream and MainStream method for CO<sub>2</sub> monitoring. LoFlo CO<sub>2</sub> module is used for SideStream measuring, Capnostat 5 CO<sub>2</sub> module (C5) is used for MainStream measuring.

√ SideStream measurement takes a sample of the respiratory gas with a constant sample flow from the patient's airway and analyzes it with a remote CO<sub>2</sub> sensor. You can measure sidestream CO<sub>2</sub> using the monitor's built-in CO<sub>2</sub> measurement.

√ MainStream measurement uses a CO<sub>2</sub> sensor attached to an airway adapter to directly insert into the patient's breathing system. This method is available using the monitor's built-in CO<sub>2</sub> measurement.

This module can be applied in operation room, monitor units etc, it can measure the CO<sub>2</sub> partial pressure or concentration of patient Air Way, obtain End tidal CO<sub>2</sub> (EtCO<sub>2</sub>), Fraction of inspired CO<sub>2</sub> (FiCO<sub>2</sub>), Air Way Respiration Rate (AwRR), and display CO<sub>2</sub> concentration waveforms. The parameter symbols displayed on the screen are defined as follows:

EtCO <sub>2</sub> :	End-tidal CO <sub>2</sub>
FiCO <sub>2</sub> :	Fraction of inspired CO <sub>2</sub>
AWRR:	Air Way Respiration (AwRR) (Resp. times/min)

---

#### **WARNING**

---

- 1 CO<sub>2</sub> module shall be avoided from crash and vibration.
  - 2 The monitor will be damaged if any pipeline from the CO<sub>2</sub> module has been disconnected, or the air tube /the air inlet /the air outlet been plugged by water or other materials.
  - 3 The accuracy of the measurement of the CO<sub>2</sub> will be affected by the following reasons: the air way was highly obstructed or air leak; the leakage of air way connection or quick variation of environment temperature.
  - 4 Follow precautions for electrostatic discharge (ESD) and electromagnetic interference (EMI) to and from other equipment.
  - 5 Do not place the sensor cables or tubing in any manner that may cause entanglement or strangulation.
  - 6 Do not store the CO<sub>2</sub> Module at temperatures less than -40° F (-40° C) or greater than 158° F (70° C).
  - 7 Do not operate the CO<sub>2</sub> Module at temperatures less than 32° F (0° C) or greater than 104° F (40° C).
  - 8 In the presence of electromagnetic devices (i.e., electrocautery), patient monitoring may be interrupted due to electromagnetic interference. Electromagnetic fields up to 20V/m will not adversely affect module performance.
-

**NOTE:**

- 1 Do not use the device in the environment with flammable anesthetic gas.
- 2 Device is to be used by trained and qualified medical personnel authorized by EDAN.
- 3 Nitrous oxide, elevated levels of oxygen, helium, xenon, halogenated hydrocarbons, and barometric pressure can influence the CO<sub>2</sub> measurement.

## 9.2 Preparing for CO<sub>2</sub> Monitoring

Principle of CO<sub>2</sub> measurement is primarily based on the fact that CO<sub>2</sub> molecule can absorb 4.3 $\mu$ m infrared ray. Absorption intensity is proportional to CO<sub>2</sub> concentration of patient sample, the CO<sub>2</sub> concentration will compute from the detecting CO<sub>2</sub> absorption intensity of patient sample. The relation between partial pressure and percentage of CO<sub>2</sub> concentration is given below:

$$P \text{ (mmHg)} = \text{Percentage (\%)} \times P_{\text{amp}} \text{ (Ambient Pressure)}$$

**NOTE:**

- a) The accuracy of the CO<sub>2</sub> measurement will be affected by the following facts:
  - The air way was highly obstructed or air leak;
  - The leakage of air way connection;
  - Quick variation of environment temperature.
- b) If the CO<sub>2</sub> waveform appears abnormal, inspect the CO<sub>2</sub> airway adapters and replace if needed.

### LoFlo CO<sub>2</sub> module setup:

**NOTE:**

You must perform a zero as described in this procedure each time the ambient temperature changes more than 10°C (for example during transport).



Figure 9-1 LoFlo CO<sub>2</sub> Module

- 1 Plug the sensor cable into the monitor's CO<sub>2</sub> input connector. Allow two minutes for the sensor warm-up.
- 2 Connect the cannula, airway adapter, or sample line as appropriate, to the sensor. It will click into place when seated correctly.



Figure 9-2 Connecting LoFlo Module

- 3 To zero the sensor:
  - Expose the sensor to room air and keep it away from all sources of CO<sub>2</sub> including the ventilator, the patient's breath and your own.
  - In the **CO<sub>2</sub> SETUP** menu, select **ZERO CAL**.
  - The messages indicate state: **zero started** > **zero successful**. After the zero calibration is finished, user can start CO<sub>2</sub> monitoring.
- 4 For intubated patients requiring an airway adapter;

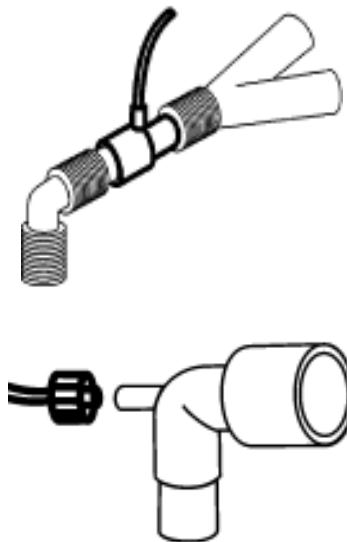

Figure 9-3 Air Adapter

For non-intubated patients: place the nasal cannula onto the patient.



Figure 9-4 Place the Nasal Cannula

**NOTE:**

- 1 Always connect the airway adapter to the sensor before inserting the airway adapter into the breathing circuit. In reverse, always remove the airway adapter from the breathing circuit before removing the sensor.
- 2 Always disconnect the cannula, airway adapter or sample line from the sensor when not in use.

**C5 CO<sub>2</sub> Module:**

**NOTE:**

You must perform a zero calibration as described in this procedure each time you use a new airway adapter.



Figure 9-5 C5 CO<sub>2</sub> Module

- 1 Attach the sensor connector to the CO<sub>2</sub> connector on the monitor.
- 2 Wait 2 minutes, allowing the sensor to reach its operating temperature and a stable thermal condition.
- 3 Choose the appropriate airway adapter and connect it to the sensor head. The airway adapter clicks into place when seated correctly.

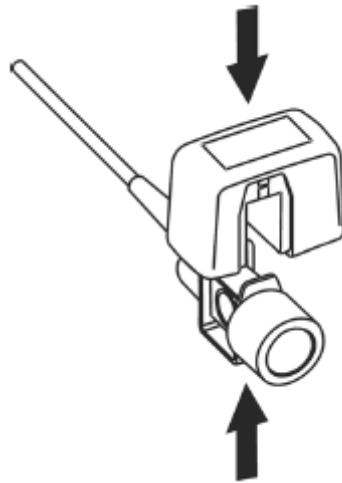

Figure 9-6 Connecting Sensor

- 4 To zero the sensor:
  - Expose the sensor to room air and keep it away from all sources of CO<sub>2</sub> including the ventilator, the patient's breath and your own.
  - In the **CO<sub>2</sub> SETUP** menu, select **ZERO CAL**.
  - The messages indicate state: **zero started** > **zero successful**. After the zero calibration is finished, user can start CO<sub>2</sub> Monitoring.
- 5 Install the airway adapter at the proximal end of the circuit between the elbow and the ventilator Y-section.

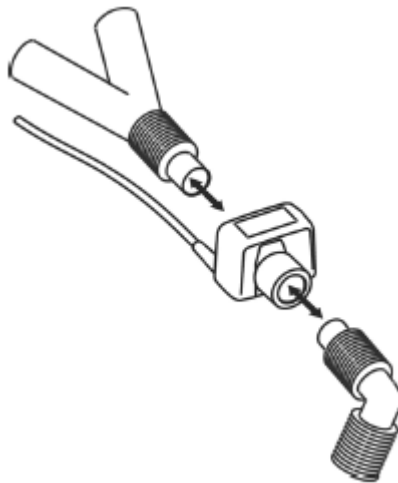

Figure 9-7 Connecting Airway Adapter

**NOTE:**

- 1 Replace the airway adapter, if excessive moisture or secretions are observed in the tubing or if the CO<sub>2</sub> waveform changes unexpectedly without a change in patient status.
- 2 To avoid infection, use only sterilized, disinfected or disposable airway adapters.
- 3 Inspect the airway adapters prior to use. Do not use if airway adapter appears to



have been damaged or broken. Observe airway adapter color coding for patient population.

- 4 The CO<sub>2</sub> sensor should be compared against calibration gas every 12 months.
- 5 Accuracy is affected by temperature and barometric pressure.
- 6 Periodically check the flow sensor and tubing for excessive moisture or secretion buildup.
- 7 It is forbidden to insert or draw out the module when the monitor is working, for it can cause instability of the system. If you do it unconsciously, please turn off the module in menu immediately. The module enters **STANDBY** mode if you reconnect it to monitor which is powered on. If the readings are inaccurate, you should do calibration.

## 9.3 CO<sub>2</sub> Setup Menu

### 9.3.1 CO<sub>2</sub> Setup

Select **CO<sub>2</sub> SETUP** in **SYSTEM MENU** as shown below:

CO2 SETUP	
WAVE SCALE	LOW
BARO PRESS	760mmHg
O2 COMPENS	16%
ANE AGENT	0.0%
BALAN GAS	ROOM AIR
APNEA ALM	20S
ZERO CAL	
EXIT	

Figure 9-8 CO<sub>2</sub> Setup Menu

Now we introduce the functions of each item in **CO<sub>2</sub> SETUP** submenu.

- **WAVE SCALE:** Adjust full scale size of CO<sub>2</sub> waveform display area with **LOW** or **HIGH** selectable. The default value is **LOW**.
- **BARO PRESS:** set the barometric pressure value. For gaining accurate readings, you should set this barometric pressure correctly.

<b>Altitude</b>	<b>Barometric Pressure</b>
<b>Meters</b>	<b>mmHg</b>
Sea Level	760
152.4	745
228.6	738
304.8	731
457.2	717
609.6	704
762	690
914.9	677
1066.8	665
1219.2	652
1371.6	640
1524	628
1676.4	616
1828.8	604
1981.2	593
2133.6	581
2286	570
2438.4	560
2590.8	549
2743.2	539
3048	518
3200.4	509
3352.8	499
3505.2	490
3657.6	480
3810	471
3962.4	462
4114.8	454
4267.2	445
4419.6	437
4572	428
4724.4	420
4876.8	412
5029.2	405
5120.6	400

Table 9-1

- **O<sub>2</sub> COMPENS:** to adjust the O<sub>2</sub> compensating concentration as per the selection of the user. Input the proper O<sub>2</sub> compensating value according to the O<sub>2</sub> concentration of the inhaled gas.
- **ANE AGENT:** to adjust the anesthetic compensating concentration as per the selection of the user. The concentration ranges from 0~20%. Input the proper concentration value

according to the anesthetic gas concentration of the inhaled gas.

- **BALAN GAS:** to balance the gas compensating operations. Select the different compensating types for balancing gas. The compensate types are **ROOM AIR**, **N<sub>2</sub>O** and **HELIUM**.
- **APNEA ALM:** After selecting the alarm time for **APNEA** alarm (having 7 levels, which are **10S**, **15S**, **20S**, **25S**, **30S**, **35S** and **40S**), the **CO<sub>2</sub> APNEA** information will appear on the screen after the corresponding selected time. The alarm level is **HIGH**.
- **ZERO CAL:** used to perform CO<sub>2</sub> model zero calibration.

When a dramatic change in CO<sub>2</sub> measurement or the accuracy of reading is suspected by the clinician, the zero calibration should be operated.

First the CO<sub>2</sub> module should be taken off from the patient, then press the **CO<sub>2</sub> START/STOP** button, select **ZERO CAL** item, then the system will automatically inhale clean CO<sub>2</sub>-free room air to the air inlet of CO<sub>2</sub> module beside the monitor, and start zero calibration.

#### NOTE:

- 1 The standard barometric pressure is 760mmHg, O<sub>2</sub> concentration is about 16%. The **BARO PRESS** should be set according to local altitude, refer to table 9-1 for details.
- 2 If the **ANE AGENT**, **O<sub>2</sub> COMPENS**, **BALAN GAS** are set incorrectly, the measure readings will be seriously remote the reality, leads to wrong diagnosis.
- 3 The **ZERO CAL** needs about 20 seconds. During this period, you'd better not do other operation, such as respiration measuring. Or the zero calibration will be fail, and you should do calibration operation again.

### 9.3.2 CO<sub>2</sub> Alarm Setup

Select **ALARM SETUP** in **SYSTEM MENU**, to display the menu as shown below:

ALARM SETUP			
	ALM	ALM HI	ALM LO
EtCO <sub>2</sub>	ON	100	8
FiCO <sub>2</sub>		2	
AwRR		20	8
SpO <sub>2</sub>	ON	100	90
PR		120	50
ALM REC		OFF	
ALM REC TIME		8s	
EXIT			

Figure 9-9 Alarm Setup

The items to be set in the menu include:

- **EtCO<sub>2</sub> ALM/ FiCO<sub>2</sub> ALM/ AWRR ALM**: Select **ON** to enable and store alarm prompt when CO<sub>2</sub> parameters have alarms. Select **OFF** to disable alarm and display  beside CO<sub>2</sub>. The default is **ON**.

### **WARNING**

In order to avoid endangering the patient's life, the user should use this function cautiously.

- **EtCO<sub>2</sub> ALM HI**: to adjust the upper alarm limit of EtCO<sub>2</sub>. If the measuring value is larger than CO<sub>2</sub> upper alarm limit, **CO<sub>2</sub> TOO HIGH** appears in the Information area. After the measuring value returns to the normal one, the information disappears.
- **EtCO<sub>2</sub> ALM LO**: to adjust the lower alarm limit of EtCO<sub>2</sub>. If the measuring value is smaller than CO<sub>2</sub> lower alarm limit, **CO<sub>2</sub> TOO LOW** appears in the Information area. After the measuring value returns to the normal one, the information disappears.
- **FiCO<sub>2</sub> ALM HI**: to adjust the upper alarm limit of FiCO<sub>2</sub>. If the measuring value is larger than FiCO<sub>2</sub> upper alarm limit, **FiCO<sub>2</sub> TOO HIGH** appears in the Information area. After the measuring value returns to the normal one, the information disappears.
- **AWR ALM HI**: to adjust the upper alarm limit of AwRR. If the measuring value is larger than the upper alarm limit of AwRR, **AWRR TOO HIGH** appears in the Information area. After the measuring value returns to the normal one, the information disappears.
- **AWR ALM LO**: to adjust the lower alarm limit of AwRR. If the measuring value is smaller than the lower alarm limit of AwRR, **AWRR TOO LOW** appears in the Information area. After the measuring value returns to the normal one, the information disappears.

The default value for each items are as follows:

CO<sub>2</sub> ALM HI: when EtCO<sub>2</sub> value exceeds this limit, there will be alarm for exceeding the upper limit.

Default:

Adult:	50 mmHg
Pediatric:	50 mmHg
Neonatal:	45 mmHg

CO<sub>2</sub> ALM LO: when EtCO<sub>2</sub> value is smaller than the lower limit, there will be alarm for exceeding lower limit.

Default:

Adult:	15 mmHg
Pediatric:	20 mmHg
Neonatal:	30 mmHg

AWRR ALM HI: when parameter value exceeds this limit, there will be alarm for exceeding upper limit.

Default:

Adult: 30 rpm

Pediatric: 30 rpm

Neonatal: 100 rpm

AWRR ALM LO: when parameter value is smaller than the limit, there will be alarm for exceeding lower limit.

Default:

Adult: 8 rpm

Pediatric: 8 rpm

Neonatal: 30 rpm

FiCO<sub>2</sub> ALM HI: when parameter value exceeds this limit, there will be alarm for exceeding upper limit.

Default:

Adult: 4 mmHg

Pediatric: 4 mmHg

Neonatal: 4 mmHg

WAVE SCALE: LOW/HIGH

Default: LOW

WAVEFORM: FILLED/UNFILLED

Default: UNFILLED

BARO PRESS: 400 ~ 850mmHg

Default: 760mmHg

O<sub>2</sub> COMPENS: 0 ~ 100%

Default: 16 %

ANE AGENT: 0 ~ 20%

Default: 0.0%

BALAN GAS: ROOM AIR/N<sub>2</sub>O/HELIUM

Default: ROOM AIR

APNEA ALM: Selections are 10s to 40s

Default: 20s

## 9.4 Alarm Information and Prompt

Tables below describe the possible physiological alarms, technical alarms and prompt messages occurring during CO<sub>2</sub> measurement.

Physiological alarms:

Message	Cause	Alarm Level
CO <sub>2</sub> APNEA	In specific time interval, no RESP can be detected using CO <sub>2</sub> module.	High
CO <sub>2</sub> TOO HIGH	EtCO <sub>2</sub> measuring value is above upper alarm limit.	Medium
CO <sub>2</sub> TOO LOW	EtCO <sub>2</sub> measuring value is below lower alarm limit.	Medium
FiCO <sub>2</sub> TOO HIGH	FiCO <sub>2</sub> measuring value is above alarm limits.	Medium
AWRR TOO HIGH	AwRR measuring value is above upper alarm limit.	Medium
AWRR TOO LOW	AwRR measuring value is below lower alarm limit.	Medium

Technical alarms:

Message	Cause	Alarm Level	Remedy
CO <sub>2</sub> ROM ERR	CO <sub>2</sub> module failure	High	Stop using measuring function of CO <sub>2</sub> module; notify biomedical engineer or Manufacturer's service staff.
CO <sub>2</sub> COMM STOP	CO <sub>2</sub> module failure or communication failure	High	
CO <sub>2</sub> INT RAM ERR	CO <sub>2</sub> module failure	High	
CO <sub>2</sub> ADAPTER OCCULED	Check if the adapter is well connected or occluded.	High	Well connect the adapter again; check if the adapter is occluded.

CO <sub>2</sub> SENSOR FAULT	CO <sub>2</sub> module failure	Medium	Stop using measuring function of CO <sub>2</sub> module; notify biomedical engineer or Manufacturer's service staff.
ZERO REQUIRED	The module need to be zero calibrated.	Low	Zero the CO <sub>2</sub> module.
CHECK ADAPTER	Check if the adapter is well connected or occluded.	Low	Well connect the adapter again; check if the adapter is occluded.

Prompt message:

Message	Cause	Alarm Level
CO <sub>2</sub> STANDBY STATUS	Turn from measuring mode to standby mode, making the module in energy-saving status.	No alarm
CO <sub>2</sub> SENSOR TEMP HIGH	The temperature of CO <sub>2</sub> sensor is too high.	
CO <sub>2</sub> SENSOR TEMP LOW	The temperature of CO <sub>2</sub> sensor is too low.	
CO <sub>2</sub> WARM UP	The CO <sub>2</sub> module is at warm-up state.	

## 9.5 Maintenance and Cleaning

### NOTE:

- 1 Before cleaning the module, it should be disconnected from the monitor.
- 2 Do not immerse the module into liquid, or the module will be damaged.

### For cleaning CO<sub>2</sub> module:

1. Use a cloth dampened with isopropyl alcohol 70%, a 10% aqueous solution of sodium hypochlorite (bleach), disinfectant spray cleaner such as mild soap.
2. Wipe down with a clean water-dampened cloth to rinse and dry before use. Make certain that the sensor windows are clean and dry before reuse.

The disposable airway adapter, cannula or other disposable accessories can not be cleaned or disinfected.

## Chapter 10 Other Functions

### 10.1 Nurse Call

The monitor provides dedicated nurse call port which is connected to nurse call system through the nurse call cable to perform the nurse call function.

### 10.2 Wireless Network

The monitor can constructs wireless network through AP (Access Point). Our company arranges the qualified engineers to install and set the wireless network for the user and test the corresponding performance. For details, please refer to *Patient Monitor Wireless Network Installation Guide*.

**NOTE:**

- 1 Be aware that some network-based functions may be limited for monitors on wireless networks in comparison with those on wired networks.
- 2 The obstacle may interfere with data transmission and even cause data loss.



## Chapter 11 Accessories and Ordering Information

### **WARNING**

The specification of accessories recommended is listed below. Using other accessories may damage the monitor.

The following accessories are recommended when using this monitor.

<b>Standard accessories</b>			
<b>Part No.</b>	<b>Accessories</b>	<b>Qty.</b>	<b>Reusable or Disposable</b>
12.01.109069	EDAN SH1 Adult Reusable SpO <sub>2</sub> Sensor (Lemo)	1	Reusable
11.57.078139	Disposable CO <sub>2</sub> Nasal Cannula - Adult (Respironics 3468ADU-00)	1	Disposable
11.57.078151	Adult/Pediatric Airway adapter kit with dehumidification tubing	1	Disposable
11.57.078154	Disposable Sampling Line Kit with Dehumidification Tubing (Respironics 3475-00)	1	Disposable
01.13.36014	Power cable (EUR standard) 220V	1	Reusable
01.13.036106	Medical-grade power cable (USA standard)	1	Reusable
21.21.064168	Rechargeable Lithium-Ion Battery/TWSLB-009 (14.8V, 2.2 Ah)	1	Reusable
11.13.114214	Grounded cable	1	Reusable
<b>Optional accessories</b>			
<b>Part No.</b>	<b>Accessories</b>	<b>Qty.</b>	<b>Reusable or Disposable</b>
<b>EDAN SpO<sub>2</sub></b>			
12.01.109069	EDAN SH1 Adult Reusable SpO <sub>2</sub> Sensor (Lemo)	1	Reusable

12.01.109079	EDAN SH1 Adult Reusable SpO <sub>2</sub> Sensor (DB9)	1	Reusable
01.13.210001	EDAN SpO <sub>2</sub> Extension cable(DB9 to Lemo, 2m, TPU)	1	Reusable
12.01.110492	EDAN SH3 Neonate Warp SpO <sub>2</sub> Sensor (DB9)	1	Reusable
12.01.110515	EDAN SH4 Adult Silicone Soft-tip SpO <sub>2</sub> Sensor (DB9)	1	Reusable
02.01.110531	EDAN SH4 Adult Silicone Soft-tip SpO <sub>2</sub> Sensor (DB9) (Immersion Disinfection)	1	Reusable
12.01.110521	EDAN SH5 pediatric Silicone Soft-tip SpO <sub>2</sub> Sensor (DB9)	1	Reusable
<b>CO<sub>2</sub></b>			
12.08.078137	Respironics EtCO <sub>2</sub> module/(Side-stream) 1022054	1	Reusable
12.08.078166	LoFlo™ Module Mounting Bracket(Respironics 1027730)	1	Reusable
11.57.078139	Disposable CO <sub>2</sub> Nasal Cannula - Adult (Respironics 3468ADU-00)	1	Disposable
11.57.078140	Disposable CO <sub>2</sub> Nasal Cannula - Pediatric (Respironics 3468PED-00)	1	Disposable
11.57.078141	Disposable CO <sub>2</sub> Nasal Cannula - Infant (Respironics 3468INF-00)	1	Disposable
11.57.078154	Disposable Sampling Line Kit with Dehumidification Tubing (Respironics 3475-00)	1	Disposable
11.15.040143	Respironics CAPNOSTAT 5 EtCO <sub>2</sub> (Main-stream) Module 1015928	1	Reusable
11.59.078155	Disposable Adult Airway Adapter (6063-00)	1	Disposable
11.59.078156	Disposable Neonatal( infant/pediatric) Airway Adapter (6312-00)	1	Disposable
12.08.078138	Side-stream CO <sub>2</sub> Component/ Side-stream 1024956	1	Reusable
11.57.078142	Adult Nasal CO <sub>2</sub> with O <sub>2</sub> delivery sampling cannula	1	Disposable
11.57.078143	Pediatric Nasal CO <sub>2</sub> with O <sub>2</sub> delivery sampling cannula	1	Disposable

11.57.078144	Infant Nasal CO <sub>2</sub> with O <sub>2</sub> delivery sampling cannula	1	Disposable
11.57.101019	Adult Nasal/Oral CO <sub>2</sub> sampling cannula	1	Disposable
11.57.101020	Pediatric Nasal/Oral CO <sub>2</sub> sampling cannula	1	Disposable
11.57.101021	Adult Nasal/Oral CO <sub>2</sub> with O <sub>2</sub> delivery sampling cannula	1	Disposable
01.12.031598	Adult/Pediatric Airway adapter kit	1	Disposable
11.57.078151	Adult/Pediatric Airway adapter kit with dehumidification tubing	1	Disposable
11.57.078152	Pediatric/Infant Airway adapter kit with dehumidification tubing	1	Disposable
11.57.078158	Pediatric mask/mainstream 9960PED-00	1	Disposable
11.57.078159	Adult standard mask /mainstream 9960STD-00	1	Disposable
11.57.078160	Adult large mask /mainstream 9960STD-00	1	Disposable
11.57.078161	Band/mainstream 8751-00	1	Reusable
11.12.078162	Card Slot /Mainstream 6934-00	1	Reusable
<b>OTHERS</b>			
01.57.78035	Printing paper	1	Disposable
12.01.109480	Trolley	1	Reusable
02.01.109481	Wall hanger	1	Reusable
02.01.109592	Pole Clamp /1 piece	1	Reusable
02.01.109636	Pole Clamp /4 pieces	1	Reusable
01.13.36014	Power cable (EUR standard) 220V	1	Reusable
01.13.036106	Medical-grade power cable (USA standard)	1	Reusable
21.21.064167	Rechargeable Lithium-Ion Battery/TWSLB-008 (14.8V, 4.4 Ah)	1	Reusable
11.13.114214	Grounded cable	1	Reusable

02.01.101207	ASUS wireless AP (WL-330g EAP)	1	Reusable
11.18.078191	Flash Disk (PNY 2.0 2G USB)	1	Reusable

## Chapter 12 Warranty and Service

### 12.1 Warranty

EDAN warrants that EDAN's products meet the labeled specifications of the products and will be free from defects in materials and workmanship that occur within warranty period.

The warranty is void in cases of:

- a) damage caused by mishandling during shipping.
- b) subsequent damage caused by improper use or maintenance.
- c) damage caused by alteration or repair by anyone not authorized by EDAN.
- d) damage caused by accidents.
- e) replacement or removal of serial number label and manufacture label.

If a product covered by this warranty is determined to be defective because of defective materials, components, or workmanship, and the warranty claim is made within the warranty period, EDAN will, at its discretion, repair or replace the defective part(s) free of charge. EDAN will not provide a substitute product for use when the defective product is being repaired.

### 12.2 Contact Information

If you have any question about maintenance, technical specifications or malfunctions of devices, contact your local distributor.

Alternatively, you can send an email to EDAN service department at: [support@edan.com.cn](mailto:support@edan.com.cn).

## Appendix I Specifications

### A1.1 Classification

Anti-electroshock type	Class I equipment and internal powered equipment
EMC type	Class A
Anti-electroshock degree	SpO <sub>2</sub> , CO <sub>2</sub> BF
Ingress Protection	IPX1
Disinfection/sterilizing method	Refer to Chapter 7 ~ Chapter 9 for details.
Working system	Continuous operation equipment (no more than 7 days)
Compliant with Safety Standards	IEC60601-1:1988+A1+A2, EN60601-1:1990+A1+A2 IEC/EN 60601-1-2:2001+A1, ISO 9919, ISO 21647

### A1.2 Specifications

#### A1.2.1 Size and Weight

Size	173.5 (L) × 241 (H) × 189 (D) mm
Weight	3 kg

#### A1.2.2 Environment

Temperature	
Working	+5°C ~ +40°C
Transport and Storage	-20°C ~ +55°C
Humidity	
Working	25% ~ 80 % (no coagulate)
Transport and Storage	25% ~ 93 % (no coagulate)
Altitude	
Working	860hPa ~ 1060hPa
Transport and Storage	700hPa ~ 1060hPa
Power Supply	100V-240V~, 50Hz/60 Hz,
	Pmax=70VA, FUSE T 1.6AL

### A1.2.3 Display

Device	5.7-inch LCD, Multicolor LCD resolution: 640×480	
Messages	1 Power Indicator LED (Green)	
	1 Power on Indicator LED (Green)	
	1 Alarm Indicator LED (Orange/ Red)	
	1 Charge Indicator LED (Yellow)	
	1 Alarm Sound Indicator LED (Backlight)	
	1 CO <sub>2</sub> Working Status Indicator LED (Backlight)	
	3 Indicating modes correspond to alarm mode	
<b>NURSE CALL</b>		
Drive mode	Relay	
Electronic	≤ 1A, ≤ AC125V, ≤ DC110V	
Isolated voltage	1500V AC	
Action	Normal open	

### A1.2.4 Battery

Quantity	1	
Type	Li battery	
Power-off delay	5 min ~ 15 min (After the low battery alarm)	
Voltage	14.8 V DC	
Capacitance	2.2Ah; 4.4Ah(optional)	
Working period (At 25°C, continuous SpO <sub>2</sub> measuring, automatic NIBP measuring, automatic recording per 10min)		
Operating time	2.2Ah: 240 min	4.4Ah: 480 min
Charge time	2.2Ah: 150 min	4.4Ah: 300 min

### A1.2.5 Recorder

Record Width	48 mm
Paper Speed	25 mm/s
Recording types	Current displayed parameter list recording
	Current displayed alarm list recording
	Real-time 8s waveform recording
	Recording of all the parameter of current patient ID

### A1.2.6 Review

Trend List Recall	72 hours, 1 Min. Resolution
Alarm List Recall	800 groups

### A1.2.7 SpO<sub>2</sub>

Measuring Range	0% ~ 100%
Alarm Range	0% ~ 100%
Resolution	1 %
Accuracy	
Adult (including Pediatric)	±2 % (70%~100% SpO <sub>2</sub> )
	Undefined (0~69% SpO <sub>2</sub> )
Neonate	±3 % (70%~100% SpO <sub>2</sub> )
	Undefined (0~69% SpO <sub>2</sub> )
Pulse Rate	
Measuring range	25 bpm ~ 300 bpm
Alarm Range	30 bpm ~ 300bpm
Resolution	1 bpm
Accuracy	± 2bpm
Data update period	1 s
Wave length	
Red light	660±3 nm



Infrared light	905±5 nm
Emitted light energy	Less than 15 mW

### A1.2.8 CO<sub>2</sub>

Applicable patient type	Adult, pediatric and neonatal patients	
Method	Infra-red Absorption Technique	
Unit	mmHg / % / kPa	
C O <sub>2</sub> measuring range	EtCO <sub>2</sub>	0 ~ 150 mmHg
	FiCO <sub>2</sub>	3~50
	AwRR	2 ~ 150 (Main stream)
Resolution	EtCO <sub>2</sub>	1 mmHg
	FiCO <sub>2</sub>	1mmHg
	AwRR	1rpm
Accuracy	EtCO <sub>2</sub>	± 2 mmHg, 0 ~ 40 mmHg
		Reading ± 5%, 41 mmHg ~ 70 mmHg
		Reading ± 8%, 71 mmHg ~ 100 mmHg
		Reading ±10%, 101 mmHg ~ 150 mmHg
	AwRR	± 1 rpm
Sample gas flow rate	50ml/min	
O <sub>2</sub> compensation	Range: 0 ~ 100% Resolution: 1% Default: 16%	
Stability	Short term drift: Drift over 4 hours shall not exceed 0.8 mmHg maximum. Long term drift: Accuracy specification will be maintained over a 120 hours period.	
Suffocation alarm delay	10, 15, 20, 25, 30, 35, 40s; 20s by default	

### A1.2.9 Wireless Network

Compliant with Standard and Directive	IEEE802.11b/g, R&TTE Directive (99/5/EEC)
Frequency Range	2.412 GHz ~2.462 GHz (America) 2.412 GHz ~2.484 GHz (Japan) 2.412 GHz ~2.472 GHz (ETSI)
Working frequency segment	Ch1 ~ 11 (America) Ch1 ~ 14 (Japan) Ch1 ~ 13 (ETSI)

## Appendix II EMC Information

### Guidance and Manufacture's Declaration

#### A2.1 Electromagnetic Emissions - for all EQUIPMENT and SYSTEMS

<b>Guidance and manufacture's declaration-electromagnetic emission</b>		
The M3B is intended for use in the electromagnetic environment specified below, The customer or the user of the M3B should assure that it is used in such and environment.		
<b>Emission test</b>	<b>Compliance</b>	<b>Electromagnetic environment-guidance</b>
RF emissions CISPR 11	Group 1	The M3B uses RF energy only for its internal function. Therefore, its RF emissions are very low and are not likely to cause any interference in nearby electronic equipment.
RF emissions CISPR 11	Class A	The M3B is suitable for use in all establishments, other than domestic and those directly connected to the public low-voltage power supply network that supplies building used for domestic purposes.
Harmonic emissions IEC/EN 61000-3-2	Class A	
Voltage fluctuations /flicker emissions IEC/EN 61000-3-3	Complies	

#### A2.2 Electromagnetic Immunity - for all EQUIPMENT and SYSTEMS

<b>Guidance and manufacture's declaration – electromagnetic immunity</b>			
The M3B is intended for use in the electromagnetic environment specified below. The customer or the user of M3B should assure that it is used in such an environment.			
<b>Immunity test</b>	<b>IEC/EN 60601 test level</b>	<b>Compliance level</b>	<b>Electromagnetic environment -guidance</b>
Electrostatic discharge (ESD) IEC/EN 61000-4-2	±6 kV contact ±8 kV air	±6 kV contact ±8 kV air	Floors should be wood, concrete or ceramic tile. If floor are covered with synthetic material, the relative humidity should be at least 30%.

Electrical fast transient/burst IEC/EN 61000-4-4	$\pm 2$ kV for power supply lines	$\pm 2$ V for power supply lines	Mains power quality should be that of a typical commercial or hospital environment.
Surge IEC/EN 61000-4-5	$\pm 1$ kV differential mode $\pm 2$ kV common mode	$\pm 1$ kV differential mode $\pm 2$ kV common mode	Mains power quality should be that of a typical commercial or hospital environment.
Power frequency (50/60Hz) magnetic field IEC/EN 61000-4-8	3A/m	3A/m	Power frequency magnetic fields should be at levels characteristic of a typical location in a typical commercial or hospital environment.
Voltage dips, short interruptions and voltage variations on power supply input lines IEC/EN 61000-4-11	<5% UT (>95% dip in UT) for 0.5 cycle 40% UT (60% dip in UT) for 5 cycles 70% UT (30% dip in UT) for 25 cycles <5% UT (>95% dip in UT) for 5 sec	<5% UT (>95% dip in UT) for 0.5 cycle 40% UT (60% dip in UT) for 5 cycles 70% UT (30% dip in UT) for 25 cycles <5% UT (>95% dip in UT) for 5 sec	Mains power quality should be that of a typical commercial or hospital environment. If the user of the EUS T Ultrasound Scanner requires continued operation during power mains interruptions, it is recommended that the EUS T Ultrasound Scanner be powered from an uninterruptible power supply or a battery.
NOTE UT is the a.c. mains voltage prior to application of the test level.			

## A2.3 Electromagnetic Immunity-for EQUIPMENT and SYSTEMS that are not LIFE-SUPPORTING

<b>Guidance and manufacture's declaration – electromagnetic immunity</b>			
The M3B is intended for use in the electromagnetic environment specified below. The customer or the user of M3B should assure that it is used in such an environment.			
<b>Immunity test</b>	<b>IEC/EN 60601 test level</b>	<b>Compliance level</b>	<b>Electromagnetic environment -guidance</b>
Conducted RF IEC/EN 61000-4-6 Radiated RF IEC/EN 61000-4-3	3 Vrms 150 kHz to 80 MHz  3 V/m 80 MHz to 2.5 GHz	3Vrms  3 V/m	<p>Portable and mobile RF communications equipment should be used no closer to any part of the EUS T Ultrasound Scanner, including cables, than the recommended separation distance calculated from the equation applicable to the frequency of the transmitter.</p> <p><b>Recommended separation distance</b></p> $d = \left[ \frac{3.5}{V_1} \right] \sqrt{P}$ $d = \left[ \frac{3.5}{E_1} \right] \sqrt{P} \quad 80 \text{ MHz to } 800 \text{ MHz}$ $d = \left[ \frac{7}{E_1} \right] \sqrt{P} \quad 800 \text{ MHz to } 2.5 \text{ GHz}$ <p>Where <math>P</math> is the maximum output power rating of the transmitter in watts (W) according to the transmitter manufacturer and <math>d</math> is the recommended separation distance in metres (m).</p> <p>Field strengths from fixed RF transmitters, as determined by an electromagnetic site survey,<sup>a</sup> should be less than the compliance level in each frequency range.<sup>b</sup></p> <p>Interference may occur in the vicinity of equipment marked with the following symbol:</p> 

NOTE 1 At 80 MHz and 800 MHz, the higher frequency range applies.

NOTE 2 These guidelines may not apply in all situations. Electromagnetic propagation is affected by absorption and reflection from structures, objects and people.

<sup>a</sup> Field strengths from fixed transmitters, such as base stations for radio (cellular/cordless) telephones and land mobile radios, amateur radio, AM and FM radio broadcast and TV broadcast cannot be predicted theoretically with accuracy. To assess the electromagnetic environment due to fixed RF transmitters, an electromagnetic site survey should be considered. If the measured field strength in the location in which the *EUS T Ultrasound Scanner* is used exceeds the applicable RF compliance level above, the *EUS T Ultrasound Scanner* should be observed to verify normal operation. If abnormal performance is observed, additional measures may be necessary, such as reorienting or relocating the *EUS T Ultrasound Scanner*.

<sup>b</sup> Over the frequency range 150 kHz to 80 MHz, field strengths should be less than 3 V/m.

## A2.4 Recommended Separation Distances

### Recommended separation distances between portable and mobile RF communications equipment and the M3B Vital Signs Monitor

The *M3B* is intended for use in an electromagnetic environment in which radiated RF disturbances are controlled. The customer or the user of the *M3B* can help prevent electromagnetic interference by maintaining a minimum distance between portable and mobile RF communications equipment (transmitters) and the *M3B* as recommended below, according to the maximum output power of the communications equipment.

Rated maximum output power of transmitter (W)	Separation distance according to frequency of transmitter (m)		
	150 kHz to 80 MHz $d = \left[ \frac{3.5}{V_1} \right] \sqrt{P}$	80 MHz to 800 MHz $d = \left[ \frac{3.5}{E_1} \right] \sqrt{P}$	800 MHz to 2.5 GHz $d = \left[ \frac{7}{E_1} \right] \sqrt{P}$
0.01	<b>0.12</b>	<b>0.12</b>	<b>0.23</b>
0.1	<b>0.37</b>	<b>0.37</b>	<b>0.73</b>
1	<b>1.2</b>	<b>1.2</b>	<b>2.3</b>
10	<b>3.7</b>	<b>3.7</b>	<b>7.3</b>
100	<b>12</b>	<b>12</b>	<b>23</b>

For transmitters rated at a maximum output power not listed above, the recommended separation distance  $d$  in meters (m) can be estimated using the equation applicable to the frequency of the transmitter, where  $P$  is the maximum output power rating of the transmitter in watts (W) according to the transmitter manufacturer.

**NOTE 1:** At 80 MHz and 800 MHz, the separation distance for the higher frequency range applies.

**NOTE 2:** These guidelines may not apply in all situations. Electromagnetic propagation is affected by absorption and reflection from structures, objects and people.

P/N: 01.54.455380-10

**EDAN**  
www.edan.com.cn

EC REPRESENTATIVE

Shanghai International Trading Corp. GmbH (Hamburg)

Eiffestrasse 80, D-20537 Hamburg Germany

TEL: +49-40-2513175 FAX: +49-40-255726

E-mail: antonjin@yahoo.com.cn

EDAN INSTRUMENTS, INC.

3/F-B, Nanshan Medical Equipment Park, Nantai Rd 1019#,

Shekou, Nanshan Shenzhen, 518067 P.R. CHINA

Email: info@edan.com.cn

TEL: +86-755-2689 8326 FAX: +86-755-2689 8330