

FAVORIT 34030VI

EN User manual



 **AEG**
perfekt in form und funktion

CONTENTS

1. SAFETY INSTRUCTIONS	3
2. PRODUCT DESCRIPTION	5
3. CONTROL PANEL	5
4. PROGRAMMES	6
5. OPTIONS	7
6. BEFORE FIRST USE	7
7. DAILY USE	10
8. CARE AND CLEANING	12
9. TROUBLESHOOTING	13
10. TECHNICAL INFORMATION	16
11. ENVIRONMENT CONCERNS	16

FOR PERFECT RESULTS

Thank you for choosing this AEG product. We have created it to give you impeccable performance for many years, with innovative technologies that help make life simpler – features you might not find on ordinary appliances. Please spend a few minutes reading to get the very best from it.

Visit our website for:



Get usage advice, brochures, trouble shooter, service information:
www.aeg.com



Register your product for better service:
www.aeg.com/productregistration



Buy Accessories, Consumables and Original spare parts for your appliance:
www.aeg.com/shop

CUSTOMER CARE AND SERVICE

We recommend the use of original spare parts.
When contacting Service, ensure that you have the following data available.
The information can be found on the rating plate. Model, PNC, Serial Number.



Warning / Caution-Safety information



General information and tips



Environmental information

Subject to change without notice.

1. SAFETY INSTRUCTIONS

Before the installation and use of the appliance, carefully read the supplied instructions. The manufacturer is not responsible if an incorrect installation and use causes injuries and damages. Always keep the instructions with the appliance for future reference.

1.1 Children and vulnerable people safety



WARNING!

Risk of suffocation, injury or permanent disability.

- Do not let persons, children included, with reduced physical sensory, reduced mental functions or lack of experience and knowledge use the appliance. They must have supervision or instruction for the operation of the appliance by a person who is responsible for their safety. Do not let children play with the appliance.
- Keep all packaging away from children.
- Keep all detergents away from children.
- Keep children and pets away from the appliance door when it is open.

1.2 Installation

- Remove all the packaging.
- Do not install or use a damaged appliance.
- Do not install or use the appliance where the temperature is less than 0 °C.
- Obey the installation instruction supplied with the appliance.
- Make sure that the appliance is installed below and adjacent to safe structures.

Water connection

- Make sure not to cause damage to the water hoses.
- Before you connect the appliance to new pipes or pipes not used for a long time, let the water flow until it is clean.

- The first time you use the appliance, make sure that there is no leakage.
- The water inlet hose has a safety valve and a sheath with an inner mains cable.

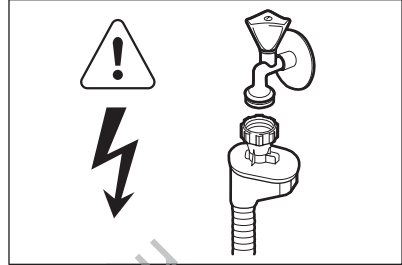

WARNING!

Dangerous voltage.

- If the water inlet hose is damaged, immediately disconnect the mains plug from the mains socket. Contact the service to replace the water inlet hose.

Electrical connection



WARNING!

Risk of fire and electrical shock.

- The appliance must be earthed.
- Make sure that the electrical information on the rating plate agrees with the power supply. If not, contact an electrician.
- Always use a correctly installed shock-proof socket.
- Do not use multi-plug adapters and extension cables.
- Make sure not to cause damage to the mains plug and to the mains cable. Contact the service or an electrician to change a damaged mains cable.
- Connect the mains plug to the mains socket only at the end of the installation. Make sure that there is access to the mains plug after the installation.
- Do not pull the mains cable to disconnect the appliance. Always pull the mains plug.
- **Only for UK and Ireland.** The appliance has a 13 amp mains plug. If it is necessary to change the fuse in the

mains plug, use a 13 amp ASTA (BS 1362) fuse.

1.3 Use

- This appliance is intended to be used in household and similar applications such as:
 - Staff kitchen areas in shops, offices and other working environments
 - Farm houses
 - By clients in hotels, motels and other residential type environments
 - Bed and breakfast type environments.



WARNING!

Risk of injury.

- Do not change the specification of this appliance.
- Put knives and cutlery with sharp points in the cutlery basket with the points down or in a horizontal position.
- Do not keep the appliance door open without supervision to prevent to fall on it.
- Do not sit or stand on the open door.
- Dishwasher detergents are dangerous. Obey the safety instructions on the detergent packaging.

- Do not drink and play with the water in the appliance.
- Do not remove the dishes from the appliance until the programme is completed. There can be detergent on the dishes.



WARNING!

Risk of electrical shock, fire or burns.

- Do not put flammable products or items that are wet with flammable products in, near or on the appliance.
- Do not use water spray and steam to clean the appliance.
- The appliance can release hot steam if you open the door while a programme operates.

1.4 Disposal



WARNING!

Risk of injury or suffocation.

- Disconnect the appliance from the mains supply.
- Cut off the mains cable and dispose of it.
- Remove the door catch to prevent children and pets to get closed in the appliance.

2. PRODUCT DESCRIPTION

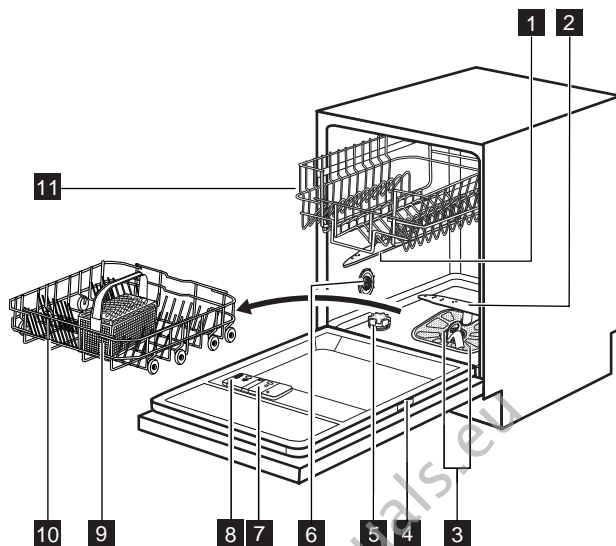

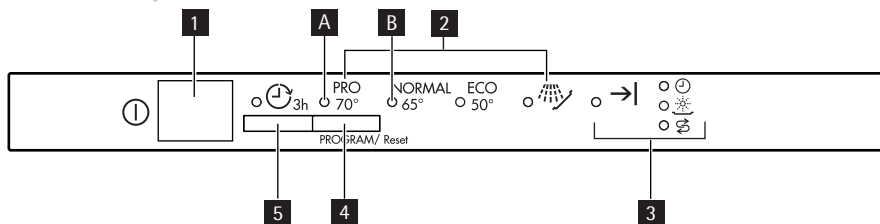

- | | |
|------------------------------|------------------------------|
| 1 Upper spray arm | 7 Rinse aid dispenser |
| 2 Lower spray arm | 8 Detergent dispenser |
| 3 Filters | 9 Cutlery basket |
| 4 Rating plate | 10 Lower basket |
| 5 Salt container | 11 Upper basket |
| 6 Water hardness dial | |

3. CONTROL PANEL



- | | |
|-------------------------------|---------------------------|
| 1 On/off button | 4 Programme button |
| 2 Programme indicators | 5 Delay button |
| 3 Indicators | |

Indicators	Description
→	End indicator.

Indicators	Description
	Wash indicator.
	Rinse aid indicator. This indicator is off while the programme operates.
	Salt indicator. This indicator is off while the programme operates.

4. PROGRAMMES

Programme ¹⁾	Degree of soil Type of load	Programme phases	Duration (min)	Energy (kWh)	Water (l)
PRO 70° ²⁾	Heavy soil Crockery, cutlery, pots and pans	Prewash Wash 70 °C Rinses Dry	120-130	1.8-2.0	22-24
NORMAL 65°	Normal soil Crockery and cutlery	Prewash Wash 65 °C Rinses Dry	100-110	1.4-1.6	19-21
ECO 50° ³⁾	Normal soil Crockery and cutlery	Prewash Wash 50 °C Rinses Dry	130-140	1.0-1.2	14-16
 ⁴⁾	All	Prewash	12	0.1	5

- 1) The pressure and the temperature of the water, the variations of the mains supply, the options and the quantity of dishes can change the programme duration and the consumption values.
- 2) This programme has a high temperature rinsing phase for better hygiene results. During the rinsing phase, the temperature stays at 70 °C for 10 to 14 minutes.
- 3) This is the standard programme for test institutes. With this programme you have the most efficient use of water and energy consumption for crockery and cutlery with normal soil.
- 4) Use this programme to quickly rinse the dishes. This prevents the remaining food to bond on the dishes and bad odours to come out from the appliance.
Do not use detergent with this programme.

Information for test institutes

For all the necessary information for test performance. send an email to:

info.test@dishwasher-production.com

Write down the product number (PNC) that is on the rating plate.

5. OPTIONS

5.1 Acoustic signals

The acoustic signals operate in these conditions:

- When the programme is completed.
- A malfunction occurs to the appliance.



Factory setting: on.
You can deactivate the acoustic signals.

Deactivating the acoustic signals

1. Press the on/off button to activate the appliance.
2. Make sure that the appliance is in setting mode. Refer to 'SETTING AND STARTING A PROGRAMME'.
3. Press and hold the programme button until the programme indicator (A) flashes and the programme indicator (B) comes on.
4. Press immediately the programme button.
 - The programme indicator (A) comes on with a fixed light.
 - The programme indicator (B) starts to flash.

5. Wait until the programme indicator (A) goes off and the end indicator comes on (the programme indicator (B) continues to flash).
 - The acoustic signals are on.
6. Press the programme button. The end indicator goes off.
 - The acoustic signals are off.
7. Deactivate the appliance to confirm the setting.

Activating the acoustic signals

1. Refer to 'Deactivating the acoustic signals', step (1) through (4).
2. Wait until the programme indicator (A) goes off. The end indicator is off and programme indicator (B) continues to flash.
 - The acoustic signals are off.
3. Press the programme button. The end indicator comes on.
 - The acoustic signals are on.
4. Deactivate the appliance to confirm the setting.

6. BEFORE FIRST USE

1. Make sure that the set level of the water softener agrees with the water hardness in your area. If not, adjust the water softener. Contact your local water authority to know the water hardness in your area.
2. Fill the salt container.
3. Fill the rinse aid dispenser.
4. Open the water tap.
5. Processing residues can stay in the appliance. Start a programme to remove them. Do not use detergent and do not load the baskets.

appliance and bad washing results. The water softener neutralises these minerals.

The dishwasher salt keeps the water softener clean and in good conditions. Refer to the table to adjust the water softener to the right level. It makes sure that the water softener uses the correct quantity of dishwasher salt and water.



You must adjust the water softener manually and electronically.

6.1 Adjusting the water softener

Hard water contains a high quantity of minerals that can cause damage to the

Water hardness				Water softener adjustment	
German degrees (°dH)	French degrees (°fH)	mmol/l	Clarke degrees	Manual	Electronic
51 - 70	91 - 125	9.1 - 12.5	64 - 88	2 1)	10
43 - 50	76 - 90	7.6 - 9.0	53 - 63	2 1)	9
37 - 42	65 - 75	6.5 - 7.5	46 - 52	2 1)	8
29 - 36	51 - 64	5.1 - 6.4	36 - 45	2 1)	7
23 - 28	40 - 50	4.0 - 5.0	28 - 35	2 1)	6
19 - 22	33 - 39	3.3 - 3.9	23 - 27	2 1)	5 1)
15 - 18	26 - 32	2.6 - 3.2	18 - 22	1	4
11 - 14	19 - 25	1.9 - 2.5	13 - 17	1	3
4 - 10	7 - 18	0.7 - 1.8	5 - 12	1	2
< 4	< 7	< 0.7	< 5	1 2)	1 2)

1) Factory position.

2) Do not use salt at this level.

Manual adjustment

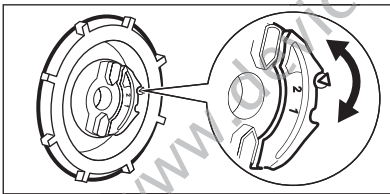

Turn the water hardness dial to the position 1 or 2.

Electronic adjustment

1. Press the on/off button to activate the appliance.
2. Make sure that the appliance is in setting mode. Refer to 'SETTING AND STARTING A PROGRAMME'.
3. Press and hold the programme button until the programme indicator (A) starts to flash and the programme indicator (B) comes on.
4. Wait until the programme indicator (B) goes off and the end indicator starts to flash (the programme indicator (A) continues to flash).
5. Press the programme button.
 - The end indicator flashes intermittently. The number of flashes shows the level of the water softener, e.g. 5 flashes + pause + 5 flashes = level 5.
6. To adjust the level of the water softener, press the programme button. Each time you press the programme button you go to the next level.
7. Deactivate the appliance to confirm the setting.

6.2 Filling the salt container

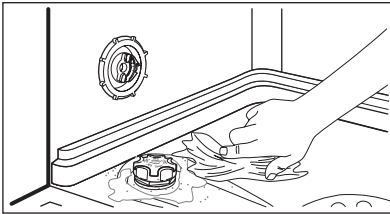
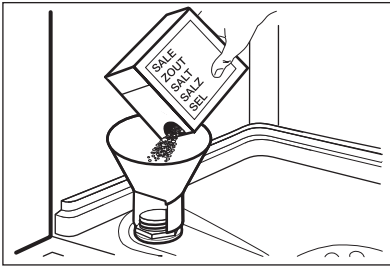

CAUTION!

Only use dishwasher salt. Other products can cause damage to the appliance. Water and salt can come out from the salt container when you fill it. Risk of corrosion. To prevent it, after you fill the salt container, start a programme.

1. Turn the cap counterclockwise and open the salt container.
2. Put 1 litre of water in the salt container (only for the first time).
3. Fill the salt container with dishwasher salt.
4. Remove the salt around the opening of the salt container.
5. Turn the cap clockwise to close the salt container.

6.3 Filling the rinse aid dispenser

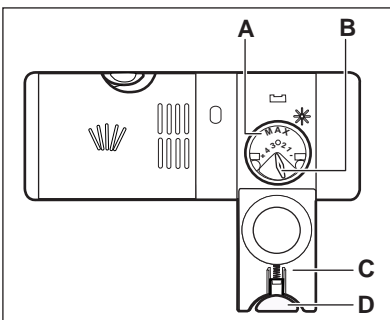
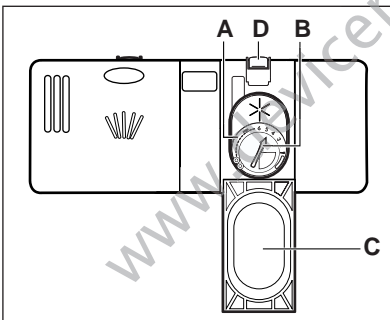

CAUTION!

Only use rinse aid for dishwashers. Other products can cause damage to the appliance.



The rinse aid, during the last rinsing phase, helps to dry the dishes without streaks and stains.

1. Press the release button (D) to open the lid (C).
2. Fill the rinse aid dispenser (A), no more than the mark 'max'.
3. Remove the spilled rinse aid with an absorbent cloth to prevent too much foam.
4. Close the lid. Make sure that the release button locks into position.



You can turn the selector of the released quantity (B) between position 1 (lowest quantity) and position 4 or 6 (highest quantity).

7. DAILY USE

1. Open the water tap.
2. Press the on/off button to activate the appliance. Make sure that the appliance is in setting mode. Refer to 'SETTING AND STARTING A PROGRAMME'.
 - If the salt indicator is on, fill the salt container.
 - If the rinse aid indicator is on, fill the rinse aid dispenser.
3. Load the baskets.
4. Add the detergent.
5. Set and start the correct programme for the type of load and soil.

- Make soft the remaining burned food on the items.
- Put hollow items (cups, glasses and pans) with the opening down.
- Make sure that cutlery and dishes do not bond together. Mix spoons with other cutlery.
- Make sure that glasses do not touch other glasses.
- Put small items in the cutlery basket.
- Put light items in the upper basket. Make sure that the items do not move.
- Make sure that the spray arms can move freely before you start a programme.

7.1 Loading the baskets



Refer to the supplied leaflet with examples of the load of the baskets.

- Only use the appliance to wash items that are dishwasher-safe.
- Do not put in the appliance items made of wood, horn, aluminium, pewter and copper.
- Do not put in the appliance items that can absorb water (sponges, household cloths).
- Remove remaining food from the items.

7.2 Using the detergent



Do not use more than the correct quantity of detergent. Refer to the instructions on the detergent packaging.

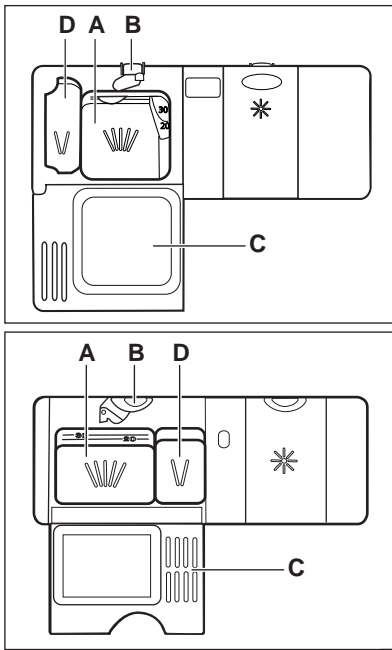

Detergent tablets do not fully dissolve with short programmes and detergent residues can stay on the dishes. We recommend that you use detergent tablets with long programmes.

**CAUTION!**

Use only detergents for dishwashers.

1. Press the release button (B) to open the lid (C).
2. Put the detergent in the compartment (A).
3. If the programme has a prewash phase, put a small quantity of detergent in the compartment (D).
4. If you use detergent tablets, put the tablet in the compartment (A).
5. Close the lid. Make sure that the release button locks into position.

7.3 Combi detergent tablets

These tablets contain detergent, rinse aid and other added agents. Be sure that these tablets are applicable to the water hardness in your area. Refer to the instructions on the packaging of the products.

When you use tablets, that contain salt and rinse aid, do not fill the salt container and the rinse aid dispenser. The rinse aid indicator always comes on if the rinse aid dispenser is empty.

1. Adjust the water softener to the lowest level.
2. Set the rinse aid dispenser to the lowest position.

If you stop to use the combi detergent tablets, before you start to use separately detergent, rinse aid and dishwasher salt, do these steps:

1. Press the on/off button to activate the appliance.

2. Set the water softener to the highest level.
3. Make sure that the salt container and the rinse aid dispenser are full.
4. Start the shortest programme with a rinsing phase, without detergent and without dishes.
5. Adjust the water softener to the water hardness in your area.
6. Adjust the released quantity of rinse aid.

7.4 Setting and starting a programme

Setting mode

The appliance must be in setting mode to accept some operations.

The appliance is in setting mode when, after the activation, all the programme indicators are off and the end indicator flashes.

If the control panel shows other conditions, press and hold the programme button until the appliance is in setting mode.

Starting a programme without delay start

1. Open the water tap.
2. Press the on/off button to activate the appliance. Make sure that the appliance is in setting mode.
3. Press continuously the programme button until the indicator of the programme you want to set comes on.
4. Close the appliance door. The programme starts.

Starting a programme with delay start

1. Set the programme.
2. Press the delay button to delay the start of the programme of 3 hours. The delay indicator comes on.
3. Close the appliance door. The countdown starts.
 - When the countdown is completed, the programme starts.

Opening the door while the appliance operates

If you open the door, the appliance stops. When you close the door, the appliance continues from the point of interruption.

Cancelling the delay start while the countdown operates

1. Open the appliance door.

2. Press the delay button, the delay indicator goes off.
3. Close the appliance door. The programme starts.

Cancelling the programme

1. Open the appliance door.
2. Press and hold the programme button until the indicator of the set programme goes off and the end indicator flashes.



Make sure that there is detergent in the detergent dispenser before you start a new programme.

At the end of the programme

When the programme is completed, an intermittent acoustic signal operates and the end indicator comes on.

1. Press the on/off button to deactivate the appliance.
2. Close the water tap.



- Let the dishes become cold before you remove them from the appliance. Hot dishes can be easily damaged.
- First remove the items from the lower basket, then from the upper basket.
- There can be water on the sides and on the door of the appliance. Stainless steel becomes cool more quickly than the dishes.

8. CARE AND CLEANING



WARNING!

Before maintenance, deactivate the appliance and disconnect the mains plug from the mains socket.



Dirty filters and clogged spray arms decrease the washing results. Make a check regularly and, if necessary, clean them.

8.1 Cleaning the filters

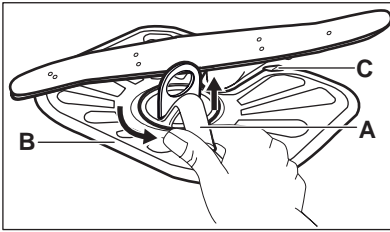

1. Turn the filter (A) counterclockwise and remove it.

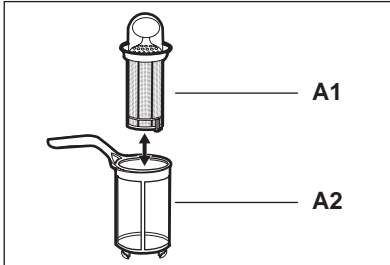

2. To disassemble the filter (A), pull apart (A1) and (A2).
3. Remove the filter (B).
4. Wash the filters with water.
5. Put the filter (B) to its initial position. Make sure that it assembles correctly under the two guides (C).

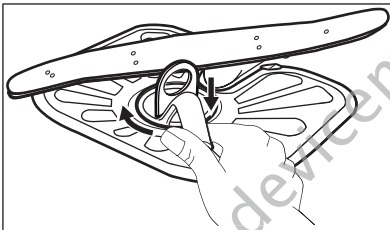

6. Assemble the filter (A) and put it into position in filter (B). Turn it clockwise until it locks.



An incorrect position of the filters can cause bad washing results and damage to the appliance.

8.2 Cleaning the spray arms

Do not remove the spray arms. If the holes in the spray arms are clogged, remove remaining parts of soil with a thin pointed object.

Only use neutral detergents. Do not use abrasive products, abrasive cleaning pads or solvents.

8.3 External cleaning

Clean the appliance with a moist soft cloth.

9. TROUBLESHOOTING

The appliance does not start or it stops during operation. Before you contact the Service, refer to the information that follows for a solution to the problem.

With some problems, different indicators flash continuously or intermittently at the same time to show an alarm code.

Alarm code	Problem
<ul style="list-style-type: none"> The indicator of the set programme flashes continuously. The end indicator flashes 1 time intermittently. 	The appliance does not fill with water.
<ul style="list-style-type: none"> The indicator of the set programme flashes continuously. The end indicator flashes 2 times intermittently. 	The appliance does not drain the water.
<ul style="list-style-type: none"> The indicator of the set programme flashes continuously. The end indicator flashes 3 times intermittently. 	The anti-flood device is on.

**WARNING!**

Deactivate the appliance before you do the checks.

Problem	Possible cause	Possible solution
The programme does not start.	The mains plug is not connected in the mains socket.	Connect the mains plug.
	The appliance door is open.	Close the appliance door.
	The fuse in the fuse box is damaged.	Replace the fuse.
	The delay start is set.	Cancel the delay start or wait for the end of the countdown.
The appliance does not fill with water.	The water tap is closed.	Open the water tap.
	The water pressure is too low.	Contact your local water authority.
	The water tap is clogged or there is limescale on it.	Clean the water tap.
	The filter in the water inlet hose is clogged.	Clean the filter.
	The water inlet hose has a kink or a bend.	Make sure that the position of the hose is correct.
The appliance does not drain the water.	The anti-flood device is on. There are water leakages in the appliance.	Close the water tap and contact the Service.
	The sink spigot is clogged.	Clean the sink spigot.
	The water drain hose has a kink or a bend.	Make sure that the position of the hose is correct.

After the checks are completed, activate the appliance. The programme continues from the point of interruption. If the problem occurs again, contact the Service.

If other alarm codes show, contact the Service.

9.1 The washing results and drying results are not satisfactory

Problem	Possible cause	Possible solution
The dishes are not clean.	The filters are clogged.	Clean the filters.
	The filters are not correctly assembled and installed.	Make sure that the filters are correctly assembled and installed.
	The spray arms are clogged.	Remove remaining soil with a thin pointed object.
	The programme was not applicable for the type of load and soil.	Make sure that the programme is applicable for the type of load and soil.
	Incorrect position of the items in the baskets. Water could not wash all items.	Make sure that the position of the items in the baskets is correct and that the water can easily wash all items.
	The spray arms could not turn freely.	Make sure that the position of the items in the baskets is correct and does not cause the blockage of the spray arms.
	The quantity of detergent was not sufficient.	Make sure that you add the correct quantity of detergent in the dispenser before you start a programme.
	There was no detergent in the detergent dispenser.	Make sure that you add detergent in the dispenser before you start a programme.
Limescale particles on the dishes.	The salt container is empty.	Make sure that there is dishwasher salt in the salt container.
	The set level of the water softener is incorrect.	Make sure that the set level of the water softener agrees with the water hardness in your area.
	The cap of the salt container is loose.	Tighten the cap.
Whitish streaks and stains or bluish layers on glasses and dishes.	The released quantity of rinse aid is too much.	Decrease the released quantity of rinse aid .

Problem	Possible cause	Possible solution
	The quantity of detergent was too much.	Make sure that you add the correct quantity of detergent in the dispenser before you start a programme.
Dry water drop stains on glasses and dishes.	The released quantity of rinse aid was not sufficient .	Increase the released quantity of rinse aid.
	The quality of the detergent can be the cause.	Try a different brand of detergent.
The dishes are wet.	The programme had no drying phase.	Set a programme with the drying phase.
The dishes are wet and matt.	The rinse aid dispenser is empty.	Make sure that there is rinse aid in the rinse aid dispenser.
	The quality of the rinse aid can be the cause.	Try a different brand of rinse aid.

10. TECHNICAL INFORMATION

Dimensions	Width / Height / Depth (mm)	596 / 818-898 / 555
Electrical connection	Refer to the rating plate.	
	Voltage	220-240 V
	Frequency	50 Hz
Water supply pressure	Min. / max. (bar / MPa)	(0.5 / 0.05) / (8 / 0.8)
Water supply ¹⁾	Cold water or hot water ²⁾	max. 60 °C
Capacity	Place settings	12
Power consumption	Left-on mode	0.99 W
	Off-mode	0.10 W

1) Connect the water inlet hose to a water tap with a 3/4" thread.

2) If the hot water comes from alternative sources of energy, (e.g. solar panels, aeolian energy), use the hot water supply to decrease energy consumption.

11. ENVIRONMENT CONCERNS

Recycle the materials with the symbol ♻️. Put the packaging in applicable containers to recycle it.

Help protect the environment and human health and to recycle waste of electrical and electronic appliances. Do not dispose

appliances marked with the symbol  with the household waste. Return the product to your local recycling

facility or contact your municipal office.

www.devicemanuals.eu

www.devicemanuals.eu

www.devicemanuals.eu

www.aeg.com/shop



www.devicemanuals.eu



156959291-A-222012