

**ZG354**

**DIRECT THERMAL BAR CODE PRINTER**

**USER'S  
MANUAL**

# Contents

- COPYRIGHT DECLARATION ..... 1
- COMPLIANCES ..... 1
- 1. Introduction** ..... 3
- 2. Getting Started**..... 3
  - 2.1 Unpacking and Inspection ..... 3
  - 2.2 Equipment Checklist..... 3
  - 2.3 Printer Parts ..... 4
    - 2.3.1 Front View ..... 4
    - 2.3.2 Rear View ..... 4
- 3 Setup** ..... 5
  - 3.1 Setting Up the Printer ..... 5
  - 3.2 Loading Label Stock..... 6
  - 3.3 Peel-Off Installation Assembly (Option)..... 8
  - 3.4 Loading Label for Peel-off Mode (Option)..... 11
  - 3.5 External Label Roll Mount Installation (Option)..... 13
  - 3.6 Cutter Module Installation (Option)..... 14
  - 3.7 Loading Label in Cutter Mode ..... 17
  - 3.8 Diagnostic Tool ..... 18
    - 3.8.1 Start the Diagnostic Tool..... 18
    - 3.8.2 Printer Function (Calibrate sensor, Ethernet setup, RTC setup)..... 19
  - 3.9 Setting Ethernet by Diagnostic Utility (Option)..... 20
    - 3.9.1 Using USB interface to setup Ethernet interface ..... 20
    - 3.9.2 Using RS-232 interface to setup Ethernet interface ..... 21
    - 3.9.3 Using Ethernet interface to setup Ethernet interface ..... 22
  - 3.10. Install Memory Card ..... 24
- 4. Power on Utilities** ..... 26
  - 4.1 Gap/Black Mark Sensor Calibration..... 26
  - 4.2 Gap/Black Mark Calibration, Self-test, Dump Mode ..... 27
  - 4.3 Printer Initialization ..... 30
  - 4.4 Set Black Mark Sensor as Media Sensor and Calibrate the Black Mark Sensor.. 31
  - 4.5 Set Gap Sensor as Media Sensor and Calibrate the Gap Sensor ..... 31
  - 4.6 Skip AUTO.BAS ..... 31
- 5. Maintenance**..... 32
  - 5.1 Cleaning ..... 32
- 6. Troubleshooting** ..... 34

□	LED Status .....	34
□	Print Quality.....	35
	<b>7. LED and Button Operation.....</b>	<b>36</b>
	7.1 LED .....	36
	7.2 Button Operation .....	36
	<b>Revise History .....</b>	<b>40</b>

# Compliances

CE Class B:

EN55022: 1998+A1: 2000+A2: 2003

EN55024: 1998+A1: 2001+A2: 2003 IEC 61000-4 Series

EN61000-3-2: 2006 & EN61000-3-3: 1995+A1: 2001

FCC Part 15, Class B

UL, CUL

C-Tick:

CFR 47, Part 15/CISPR 22 3<sup>rd</sup> Edition: 1997, Class B

ANSI C63.4: 2003

Canadian ICES-003

TÜV/Safety: EN60950: 2000

## Wichtige Sicherheits-Hinweise

1. Bitte lesen Sie diese Hinweis sorgfältig durch.
2. Heben Sie diese Anleitung für den späteren Gebrauch auf.
3. Vor jedem Reinigen ist das Gerät vom Stromnetz zu trennen. Verwenden Sie keine Flüssig-oder Aerosolreiniger. Am besten eignet sich ein angefeuchtetes Tuch zur Reinigung.
4. Die Netzanschluß-Steckdose soll nahe dem Gerät angebracht und leicht zugänglich sein.
5. Das Gerät ist vor Feuchtigkeit zu schützen.
6. Bei der Aufstellung des Gerätes ist auf sicheren Stand zu achten. Ein Kippen oder Fallen könnte Beschädigungen hervorrufen.
7. Beachten Sie beim Anschluß ans Stromnetz die Anschlußwerte.
8. Dieses Gerät kann bis zu einer Außentemperatur von maximal 40°C betrieben werden.

### **CAUTION**

1. HAZARDOUS MOVING PARTS IN CUTTER MODULE. KEEP FINGER AND OTHER BODY PARTS AWAY.
2. THE MAIN BOARD INCLUDES REAL TIME CLOCK FEATURE HAS LITHIUM BATTERY CR2032 INSTALLED. RISK OF EXPLOSION IF BATTERY IS REPLACED BY AN INCORRECT TYPE.
3. DISPOSE OF USED BATTERIES ACCORDING TO THE MANUFACTURER INSTRUCTIONS.

"ORSICHT"

Explosionsgefahr bei unsachgemäßen Austausch der Batterie. Ersatz nur durch denselben oder einem vom Hersteller empfohlenem nlichen Typ. Entsorgung gebrauchter Batterien nach Angaben des Herstellers.

**B** 급기기

(가정용 정보통신기기)

이 기기는 가정용으로 전자파 적합등록을 한 기기로서  
주거지역에서는 물론 모든 지역에서 사용할 수 있습니다.

# 1. Introduction

Thank you for purchasing the ZG354 Direct Thermal Bar Code Printer. Although it is a compact desktop printer, it is reliable and with superior throughput performance.

This printer provides direct thermal printing at user selectable speed of: 2.0, 3.0, 4.0, 5.0, 6.0 or 7.0 inches per second. It accepts roll feed, die-cut, and fan-fold labels for direct thermal printing. All common bar codes formats are available. Fonts and bar codes can be printed in 4 directions, 8 different alphanumeric bitmap fonts and a build-in true type font capability. You will enjoy high throughput for printing labels with this printer.

## 2. Getting Started

### 2.1 Unpacking and Inspection

This printer has been specially packaged to withstand damage during shipping. Please carefully inspect the packaging and printer upon receiving the bar code printer. Please retain the packaging materials in cover you need to reship the printer.

### 2.2 Equipment Checklist

- Printer
- BarTender UltraLite CD disk
- Quick start guide
- USB port cable
- External universal switching power supply
- Power Cord
- Label Spindle
- Fixing tab x2
- 1.5" core adapter x2
- How to Create your own Logo Instructions

If any parts are missing, please contact the Customer Service Department of your purchased reseller or distributor.

## 2.3 Printer Parts

### 2.3.1 Front View



### 2.3.2 Rear View

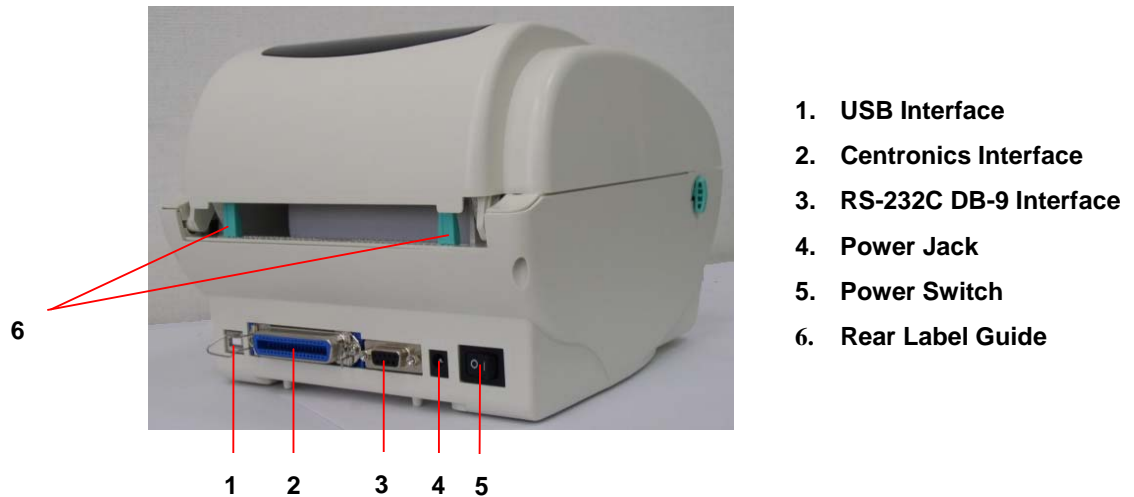

**Note:** The interface picture in the quick start guide is for reference only. Please refer to the product specification for the interfaces availability.

## 3 Setup

### 3.1 Setting Up the Printer

1. Place the printer on a flat, secure surface.
2. Make sure the power switch is off.
3. Connect the printer to the computer with the Centronics or USB cable.
4. Plug the DC power cord into the power jack at the rear of the printer, and then plug the AC power cord into a properly grounded receptacle.

**Note:** When plug power code into the rear of printer please make sure the printer power switch is off.

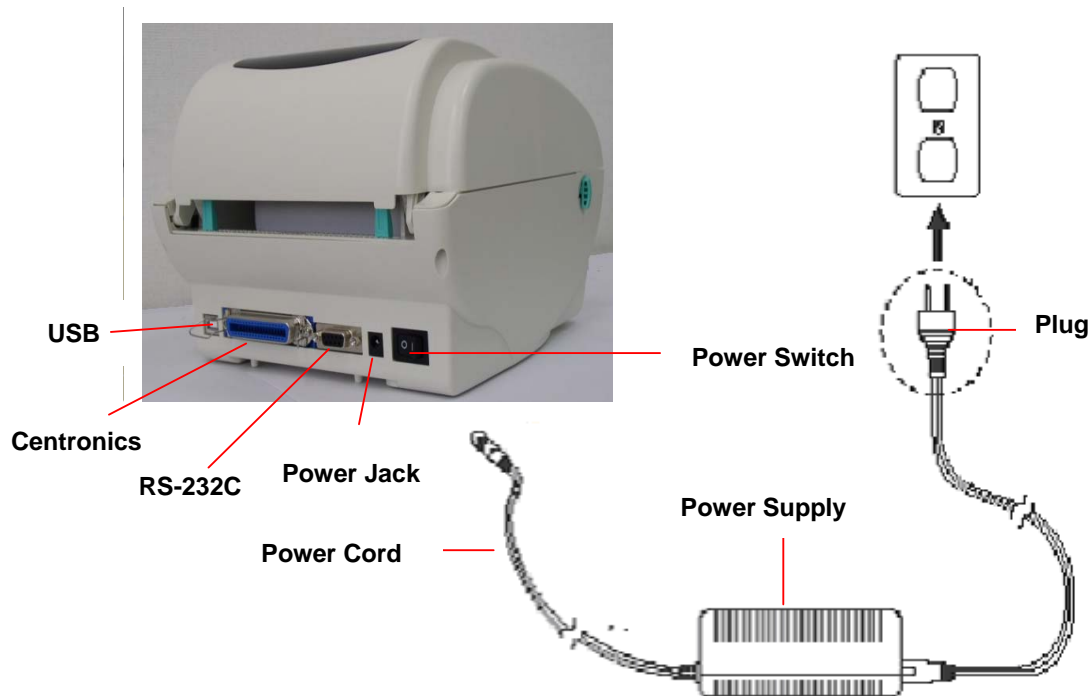



## 3.2 Loading Label Stock

1. Insert a 1" label spindle into a paper roll (If your paper core is 1 inch, remove the 1.5 inch core adapter from the fixing tab).

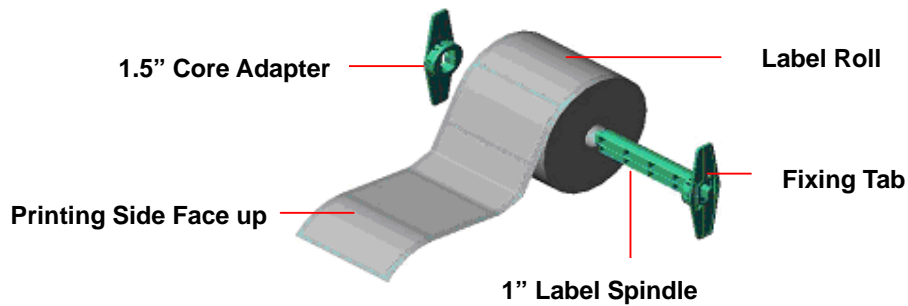

2. Open the printer's top cover by releasing the green **top cover open levers** located on both sides of the printer and lifting the top cover.
3. Place a roll of paper into internal paper roll mount.
4. Feed the paper, printing side face up, through the **label guides** and place the label over the platen.
5. Adjust the black center-biased label guides in or out by turning adjustment knob so they are slightly touch the edges of the label backing.

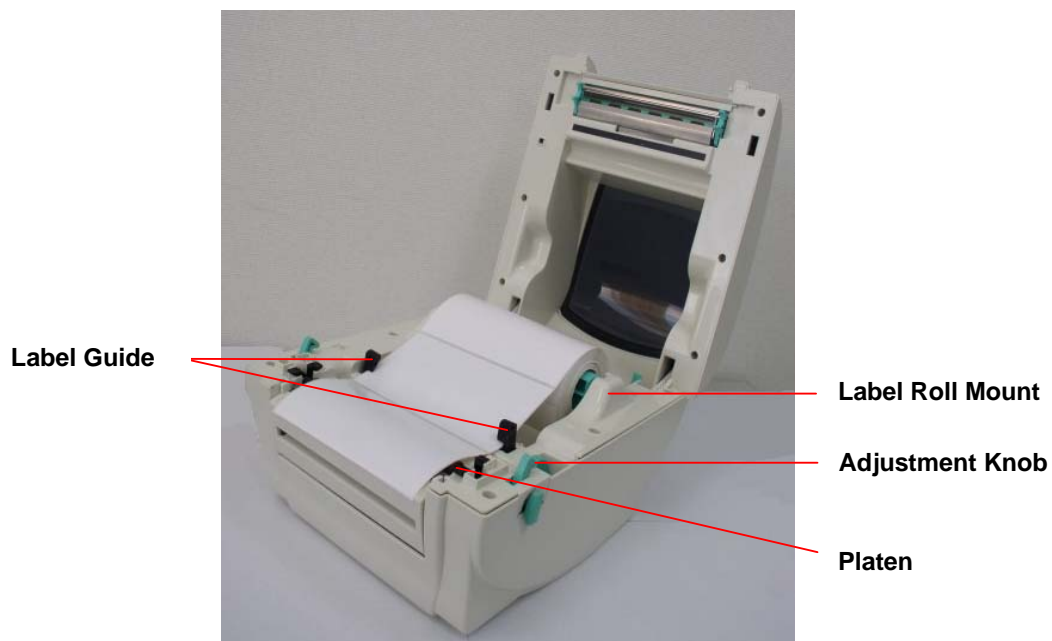

6. Close the printer top cover slowly and make sure the cover locks levers securely.

**Note: Failure to securely close and lock the cover will result in poor print quality.**



### 3.3 Peel-Off Installation Assembly (Option)

1. Open the top cover.
2. Unscrew the 6 screws in the lower inner cover.

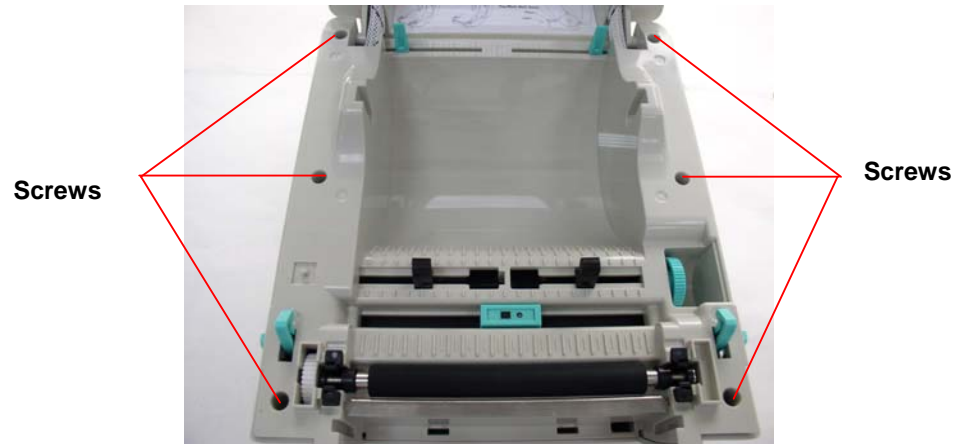

3. Upside down the printer.
4. Unscrew the 2 screws at the lower inner cover

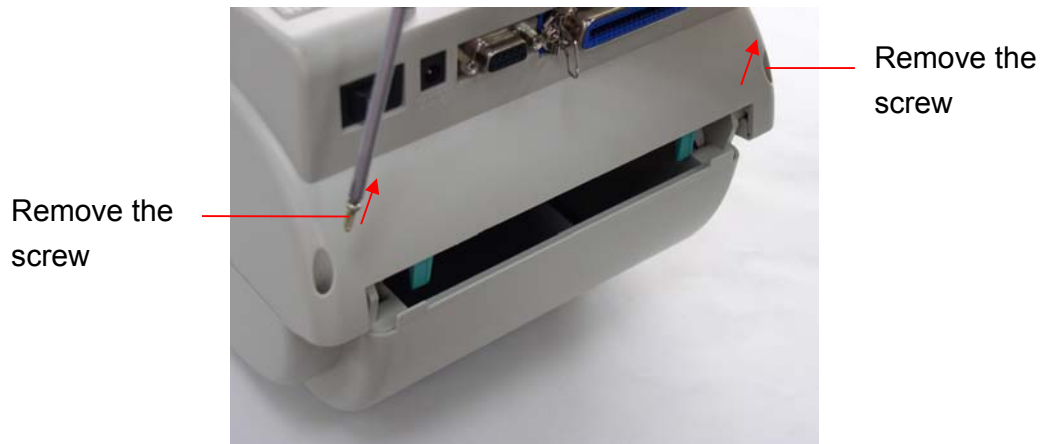

5. Remove the screw at memory card cover.



6. Hold the lower cover and lift up the top cover opening levers to separate the lower inner cover from the lower cover.

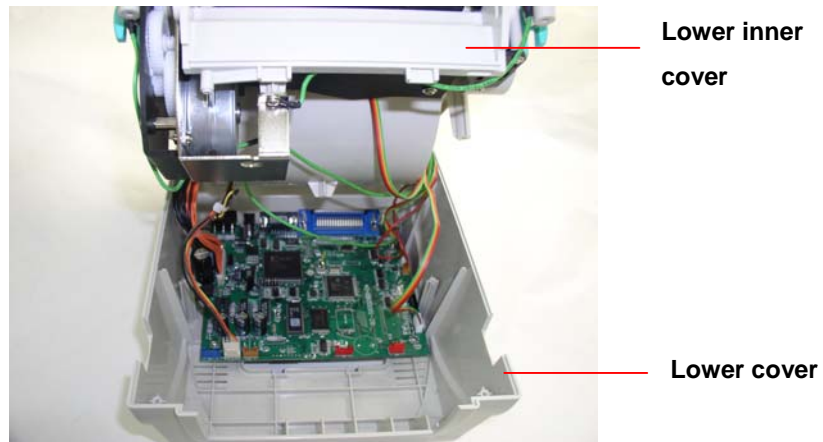

7. Thread the harness red connector through the cable hole at the front side of lower inner cover. Plug the red peel off module harness connector at the location / JP19 (ZG354) on the main board. Place lower inner cover to the lower cover. Install the peel-off module to the lower inner cover slot.

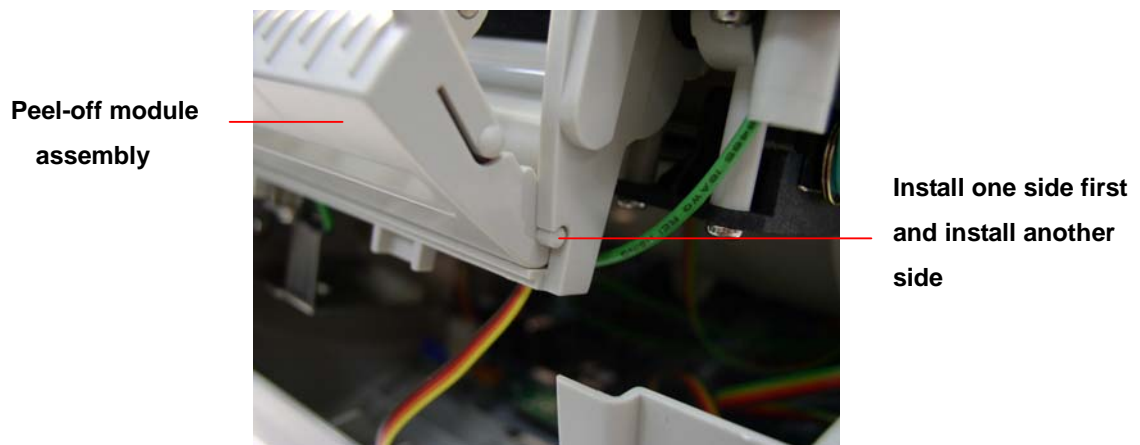

8. Gently push peel-off panel to lock to the lower inner cover.

9. Reassemble parts in reverse procedures after installing the module.



### 3.4 Loading Label for Peel-off Mode (Option)

1. Open the peel-off module by pulling it out.

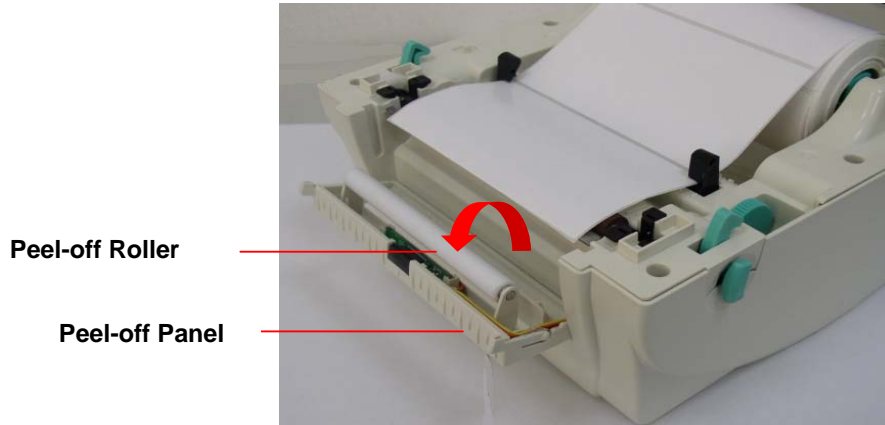

2. Thread the label, printing side facing up, through the label guides and place it on top of the platen.
3. Thread the label through the liner opening, which is beneath the roller.
4. Adjust the black center-biased **label guides** by turning adjustment knob to fit the edge of the label backing.

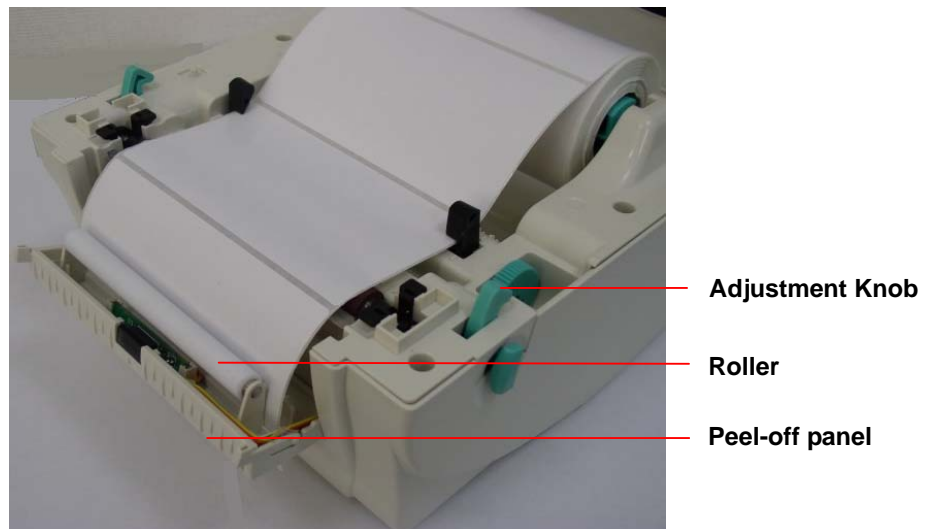

5. Push the peel-off panel back to the printer.

6. Close the top cover.



### 3.5 External Label Roll Mount Installation (Option)

1. Attach an external label roll mount on the bottom of the printer.
2. Install a roll of label on the external label roll mount.



3. Feed the label to the external label feed opening through the rear label guide.

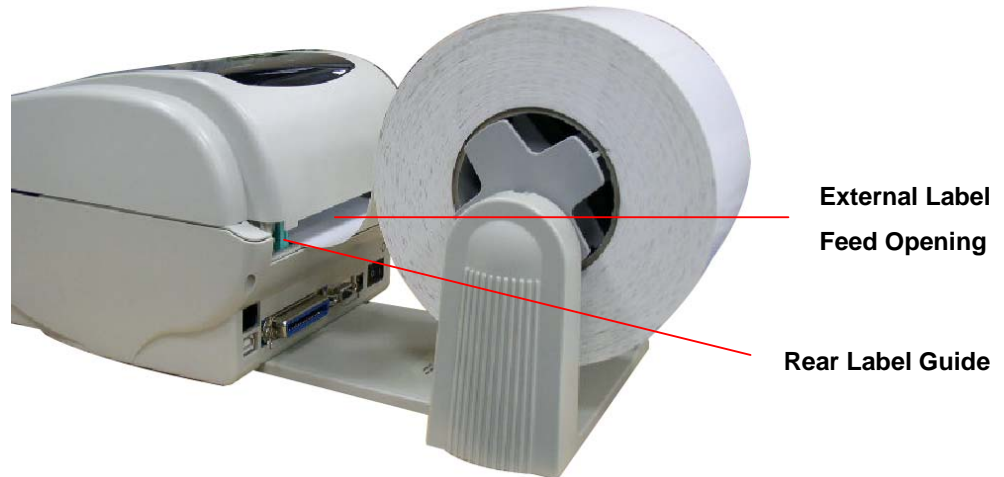

4. Open the printer top cover by pulling the top cover open levers.
5. Thread the label, printing side face up, through the label guide and place it on top the platen.
6. Adjust the label guides by turning adjustment knob to fit the edge of the label backing.
7. Close the printer top cover.



### 3.6 Cutter Module Installation (Option)

1. Pull the top cover open levers to open the top cover.
2. Remove the front panel from the lower cover.
3. Remove 6 screws on the **lower inner cover**.

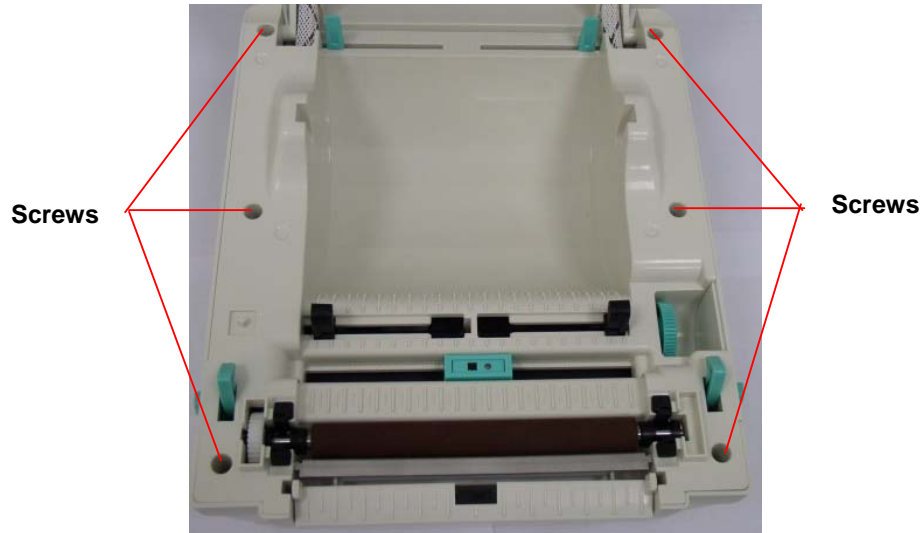

4. Upside down the printer.
5. Remove two screws at the hinge

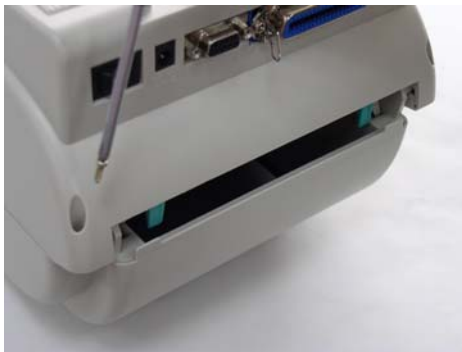

6. Remove the screw that fixes the memory card cover.

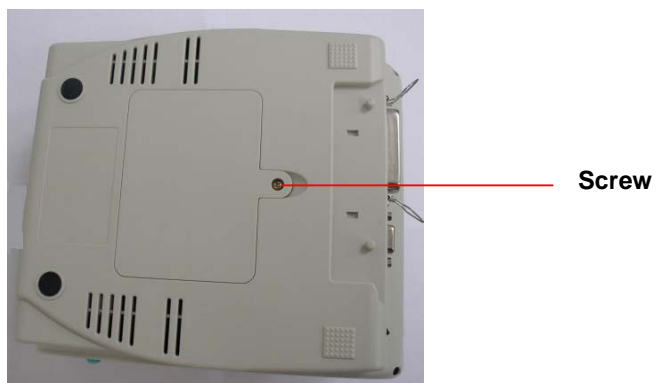

7. Plug in the Cutter Driver IC at U30 (ZG354) socket on the main board.

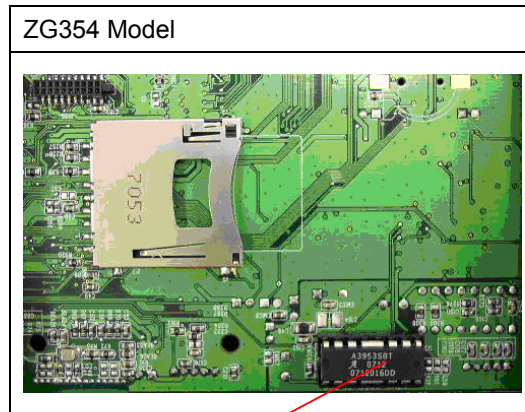

Cutter Driver IC

**Note:**

**For Non-RoHS PCB, use cutter driver IC A3952SB**

**For RoHS PCB, use cutter driver IC A3953SB**

8. Hold the lower cover and lift up the lower inner cover.

9. Arrange the cutter module harness through the bezel.

10. Connect the cutter module harness to the 4-pin socket on printer PCB.



11. Reassemble lower inner cover back to the lower cover.

12. Install the cutter module into the niche of the printer.

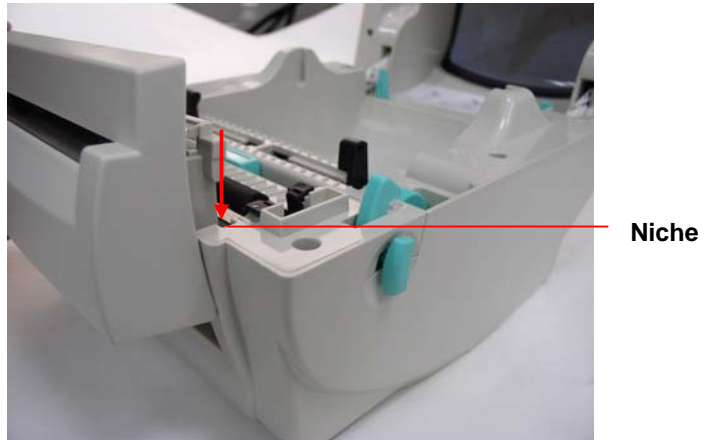

13. Reassemble the parts in the reverse order.

14. Close the top cover.

### 3.7 Loading Label in Cutter Mode

1. Open the printer top cover.
2. Insert the label spindle into label roller
3. Place a label roll to label roll mount.
4. Thread the paper, printing side face up, through the label guide, platen and cutter module paper outlet.

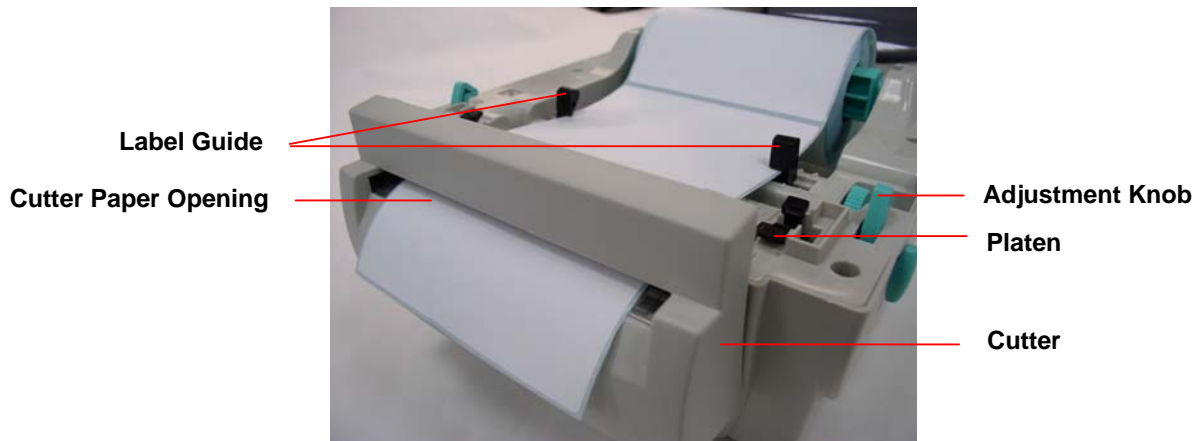

5. Adjust the black center-biased label guides to fit edge of the label backing.
6. Close the top cover.



## 3.8 Diagnostic Tool

The Diagnostic Utility is a toolbox that allows users to explore the printer's settings and status; change printer settings; download graphics, fonts, and firmware; create printer bitmap fonts; and to send additional commands to the printer. Using this convenient tool, you can explore the printer status and settings and troubleshoot the printer.

**Note:** This utility works with printer firmware V6.00 and later versions.

### 3.8.1 Start the Diagnostic Tool

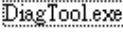
1. Double click on the Diagnostic tool icon   to start the software.
2. There are four features (Printer Configuration, File Manager, Bitmap Font Manager, Command Tool) included in the Diagnostic utility.

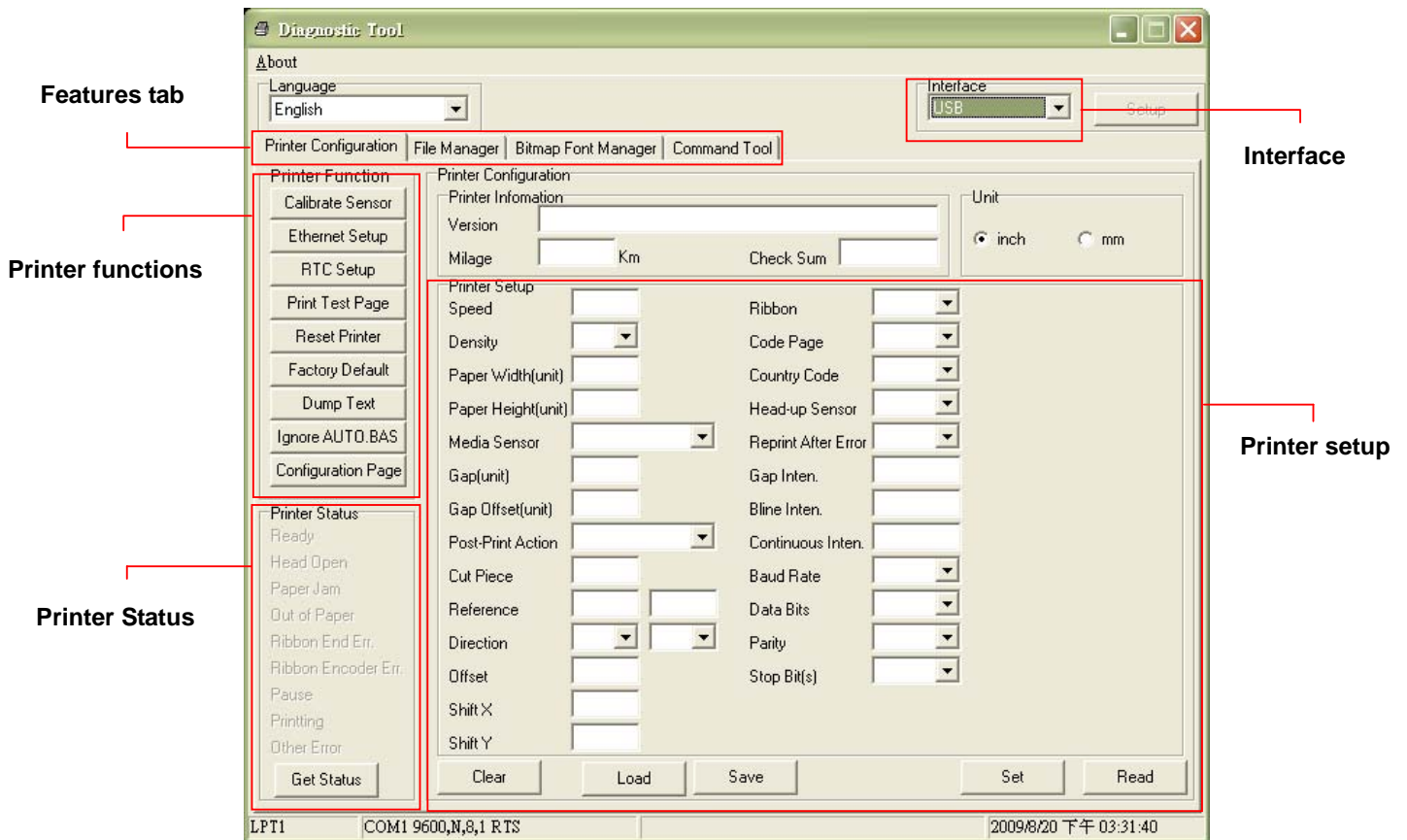

### 3.8.2 Printer Function (Calibrate sensor, Ethernet setup, RTC setup.....)

1. Select the PC interface connected with bar code printer.
2. Click the “Function” button to setting.
3. The detail functions in the Printer Function Group are listed as below.

	Function	Description
Printer Function		
Calibrate Sensor	Calibrate Sensor	Calibrate the sensor specified in the Printer Setup group media sensor field
Ethernet Setup	Ethernet Setup	Setup the IP address, subnet mask, gateway for the on board Ethernet (Please refer to next section)
RTC Setup	RTC Time	Synchronize printer Real Time Clock with PC
Print Test Page	Print Test Page	Print a test page
Reset Printer	Reset Printer	Reboot printer
Factory Default	Factory Default	Initialize the printer and restore the settings to factory default.
Dump Text	Dump Text	To activate the printer dump mode.
Ignore AUTO.BAS	Ignore AUTO.BAS	Ignore the downloaded AUTO.BAS program
Configuration Page	Configuration Page	Print printer configuration

**Note:**

For more information about Diagnostic Tool, please refer to the diagnostic utility quick start guide in the CD disk \ Utilities directory.

### 3.9 Setting Ethernet by Diagnostic Utility (Option)

The Diagnostic Utility is enclosed in the CD disk \Utilities directory. Users can use Diagnostic Tool to setup the Ethernet by RS-232, USB and Ethernet interfaces. The following contents will instruct users how to configure the Ethernet by these three interfaces.

#### 3.9.1 Using USB interface to setup Ethernet interface

1. Connect the USB cable between the computer and the printer.
2. Turn on the printer power.
3. Start the Diagnostic Utility by double clicking on the  icon.

**Note: This utility works with printer firmware V6.00 and later versions.**

4. The Diagnostic Utility default interface setting is USB interface. If USB interface is connected with printer, no other settings need to be changed in the interface field.

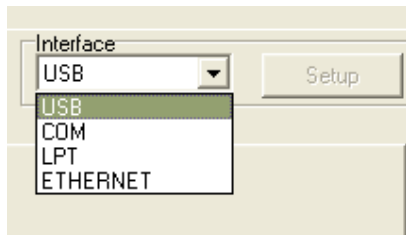

5. Click on the “Ethernet Setup” button from “Printer Function” group in Printer Configuration tab to setup the IP address, subnet mask and gateway for the on board Ethernet.

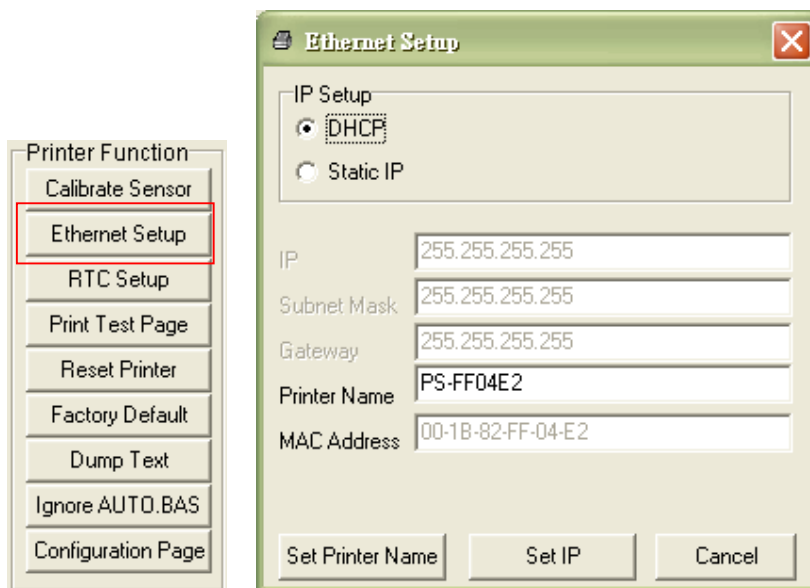

### 3.9.2 Using RS-232 interface to setup Ethernet interface

1. Connect the computer and the printer with a RS-232 cable.
2. Turn on the printer power.
3. Start the Diagnostic Utility by double clicks on the  `DiagTool.exe` icon.  
**Note: This utility works with printer firmware V6.00 and later versions.**
4. Select “COM” as interface then click on the “Setup” button to setup the serial port baud rate, parity check, data bits, stop bit and flow control parameters.

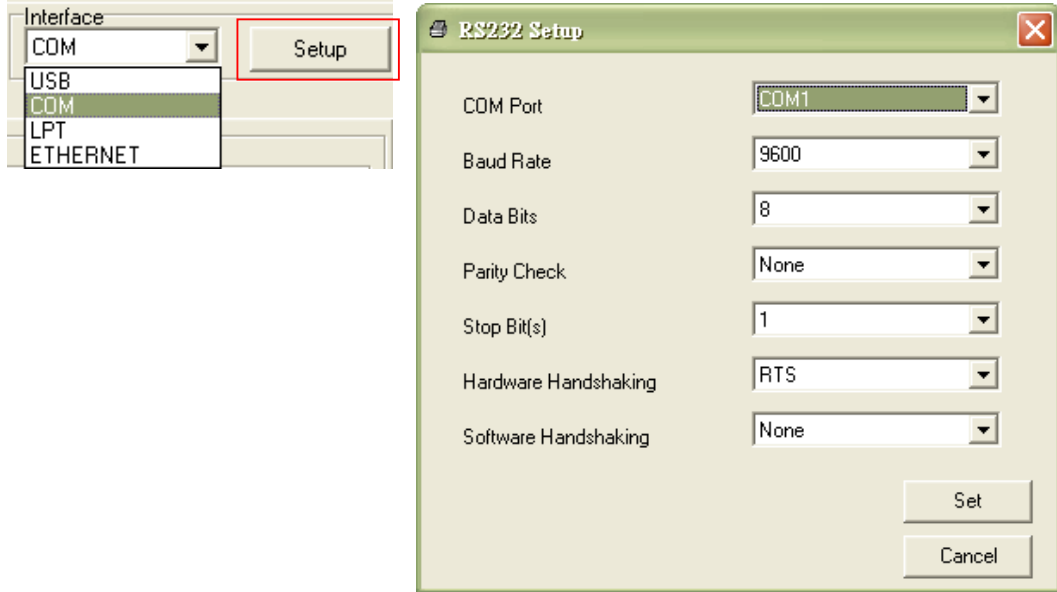

5. Click on the “Ethernet Setup” button from printer function of Printer Configuration tab to setup the IP address, subnet mask and the gateway for the on board Ethernet.

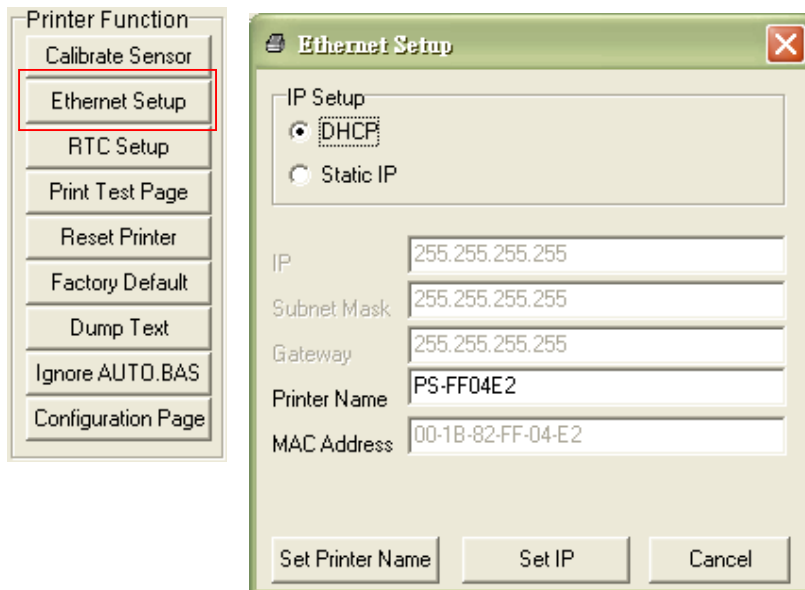



### 3.9.3 Using Ethernet interface to setup Ethernet interface

1. Connect the computer and the printer to the LAN.
2. Turn on the printer power.
3. Start the Diagnostic Utility by double clicks on the  `DiagTool.exe` icon.  
**Note: This utility works with printer firmware V6.00 and later versions.**
4. Select “Ethernet” as the interface then click on the “Setup” button to setup the IP address, subnet mask and gateway for the on board Ethernet.

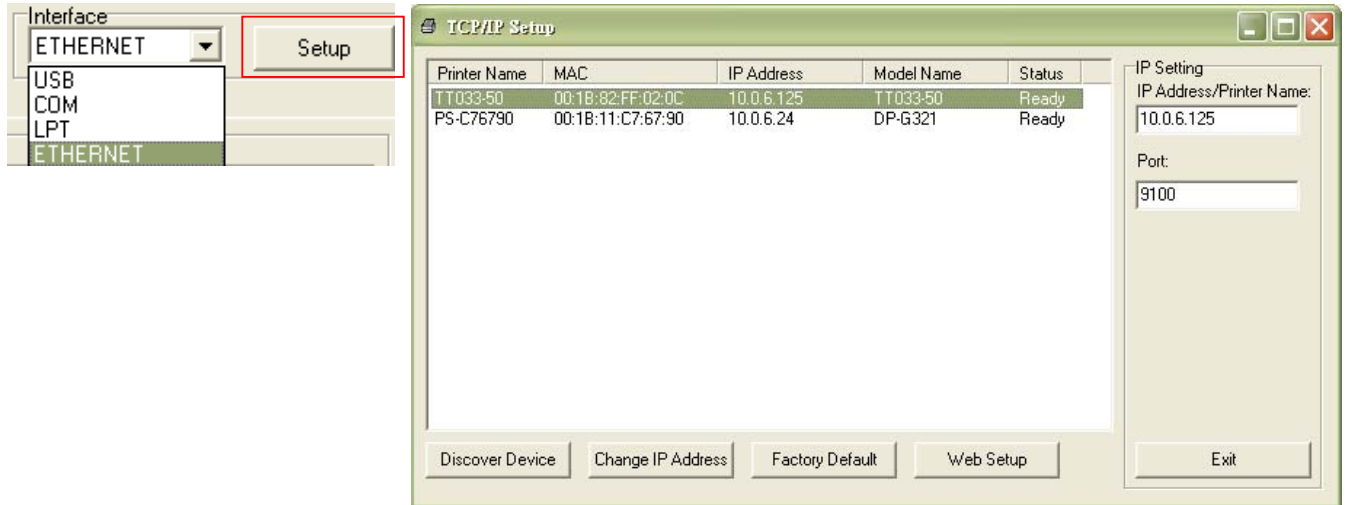

5. Click the “Discover Device” button to explore the printers that exist on the network.
6. Select the printer in the left side of listed printers, the correspondent IP address will be shown in the right side “IP address/Printer Name” field.
7. Click “Change IP Address” to configure the IP address obtained by DHCP or static.

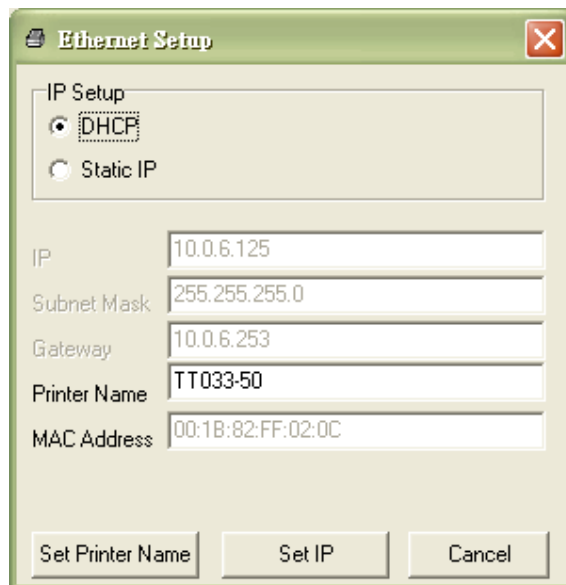

The default IP address is obtained by DHCP. To change the setting to static IP address, click “Static IP” radio button then enter the IP address, subnet mask and gateway. Click “Set IP” to take effect the settings.

Users can also change the “Printer Name” by another model name in this fields then click “Set Printer Name” to take effect this change.

***Note: After clicking the “Set Printer Name” or “Set IP” button, printer will reset to take effect the settings.***

8. Click “Exit” button to exit the Ethernet interface setup and go back to Diagnostic Tool main screen.

Factory Default button

This function will reset the IP, subnet mask, gateway parameters obtained by DHCP and reset the printer name.

Web setup button

Except to use the Diagnostic Utility to setup the printer, you can also explore and configure the printer settings and status or update the firmware with the IE or Firefox web browser. This feature provides a user friendly setup interface and the capability to manage the printer remotely over a network.

### 3.10. Install Memory Card

1. Upside down the printer.
2. Remove 1 screw and open the memory card cover.



Memory Card

3. Plug the memory card on main board.



4. Revert the memory card cover.

\* Recommended SD card specification.

<b>SD card spec</b>	<b>SD card capacity</b>	<b>Approved SD card manufacturer</b>
V1.0, V1.1	128 MB	SanDisk, Transcend
V1.0, V1.1	256 MB	SanDisk, Transcend, Panasonic
V1.0, V1.1	512 MB	SanDisk, Transcend, Panasonic
V1.0, V1.1	1 GB	SanDisk, Transcend, Panasonic
V2.0 SDHC CLASS 4	4 GB	
V2.0 SDHC CLASS 6	4 GB	SanDisk, Transcend, Panasonic
V1.0, V1.1	microSD 128 MB	Transcend, Panasonic
V1.0, V1.1	microSD 256 MB	Transcend, Panasonic
V1.0, V1.1	microSD 512 MB	Panasonic
V1.0, V1.1	microSD 1 GB	Transcend, Panasonic
V2.0 SDHC CLASS 4	microSD 4 GB	Panasonic
V2.0 SDHC CLASS 6	microSD 4 GB	Transcend
V1.0, V1.1	miniSD 128 MB	Transcend, Panasonic
V1.0, V1.1	miniSD 256 MB	Transcend, Panasonic
V1.0, V1.1	miniSD 512 MB	Transcend, Panasonic
V1.0, V1.1	miniSD 1 GB	Transcend, Panasonic
V2.0 SDHC CLASS 4	miniSD 4 GB	Transcend
V2.0 SDHC CLASS 6	miniSD 4 GB	
<ul style="list-style-type: none"> <li>- The DOS FAT file system is supported for the SD card.</li> <li>- Folders/files stored in the SD card should be in the 8.3 filename format</li> <li>- The miniSD/microSD card to SD card slot adapter is required.</li> </ul>		

## 4. Power on Utilities

There are six power-on utilities to set up and test printer hardware. These utilities are activated by pressing FEED button and by turning on the printer power simultaneously.

The utilities are listed as below:

1. Gap/Black mark sensor calibration
2. Gap/black mark sensor calibration, Self-test and Dump mode
3. Printer initialization
4. Set black mark as media sensor and calibrate the black mark sensor
5. Set gap sensor as media sensor and calibrate the gap sensor
6. Skip AUTO.BAS

### 4.1 Gap/Black Mark Sensor Calibration

Gap/black mark sensor sensitivity should be calibrated at the following conditions:

1. A brand new printer
2. Change label stock.
3. Printer initialization.

Please follow the steps below to calibrate the gap/black sensor :

1. Turn off the power switch.
2. Hold on the button then turn on the power switch.
3. Release the button when LED becomes **red** and blinking. (Any red will do during the 5 blinks).

- It will calibrate the gap/black mark sensor sensitivity.
- The LED color will be changed as following order :  
Amber → **red (5 blinks)** → amber (5 blinks) → green (5 blinks) → green/amber (5 blinks) → red/amber (5 blinks) → solid green
- It calibrates the sensor and measures the label length.

#### Note:

Please select gap or black mark sensor by **GAP** or **BLINE** command prior to calibrate the sensor.

For more information about **GAP** and **BLINE** command, please refer to **TSPL2 programming manual**.

## 4.2 Gap/Black Mark Calibration, Self-test, Dump Mode

While calibrate the gap/black mark sensor, printer will measure the label length, print the internal configuration (self-test) and then enter the dump mode.

Please follow the steps as below.

1. Turn off the power switch.
2. Hold on the button then turn on the power switch.
3. Release the button when LED becomes **amber** and blinking. (Any amber will do during the 5 blinks).
  - The LED color will be changed as following order.  
Amber → red (5 blinks) → **amber (5 blinks)** → green (5 blinks) → green/amber (5 blinks) → red/amber (5 blinks) → solid green
  - It calibrates the sensor and measures the label length and prints internal settings then enter the dump mode.

### Note:

Please select gap or black mark sensor by Diagnostic Tool or by GAP or BLINE command prior to calibrate the sensor.

For more information about GAP and BLINE command, please refer to TSPL2 programming manual.

## Self-test

Printer will print the printer configuration after gap/black mark sensor calibration. Self-test printout can be used to check if there is any dot damage on the heater element, printer configurations and available memory space.

Self-test printout	
<pre>PRINTER INFO. XXXXXXXXXXXXXXXXXXXXXXXXXXXXXXXXXXXXXXXXXXXXXXXXXXXXXXXXXXXX XXXXXXXXXXXXXXXXXXXXXXXXXXXXXXXXXXXXXXXXXXXXXXXXXXXXXXXXXXXX XXXXXXXXXX Version: X.XX MILAGE(m): 0 CHECKSUM: XXXXXXXX SERIAL PORT: 9600,N,8,1 CODE PAGE: 850 COUNTRY CODE: 001 SPEED: X INCH DENSITY: 8 SIZE: 4.00 , 4.00 GAP: 0.12 , 0.00 TRANSPARENCE: XX ***** FILE LIST: DRAM FILE:          0 FILE(S) FLASH FILE:         0 FILE(S) PHYSICAL DRAM:     XXXX KBYTES AVAILABLE DRAM:    XXXX KBYTES FREE PHYSICAL FLASH:    XXXX KBYTES AVAILABLE FLASH:   XXXX KBYTES FREE END OF FILE LIST *****</pre>	<p>Print head check pattern</p> <p>Model name and F/W version</p> <p>Printed mileage (meter)</p> <p>Firmware checksum</p> <p>Serial port configuration</p> <p>Code page</p> <p>Country code</p> <p>Print speed (inch/sec)</p> <p>Print darkness</p> <p>Label size (inch)</p> <p>Gap distance (inch)</p> <p>Gap/black mark sensor sensitivity</p> <p>Numbers of download files</p> <p>Total &amp; available memory space</p>

### Note:

1. The physical flash memory for RoHS compliant version is 2MB Flash and 2MB DRAM (
2. System occupies 960 KB in Flash memory so total flash memory space for user downloading is 1088 KB
3. System occupies 1792 KB in DRAM so total DRAM memory space for user downloading is 256 KB  
System occupies 7936 KB in SDRAM so total SDRAM memory space for user downloading is 256 KB

## Dump mode

Printer will enter dump mode after printing printer configuration. In the dump mode, all characters will be printed in 2 columns as following. The left side characters are received from your system and right side data are the corresponding hexadecimal value of the characters. It allows users or engineers to verify and debug the program.

```

SPEED 2.0      53 50 45 45 44 20 32 2E 30 0D
 DENSITY 8    0A 44 45 4E 53 49 54 59 20 38
  SET PEEL    0D 0A 53 45 54 20 50 45 45 4C
 OFF DIRE     20 4F 46 46 0D 0A 44 49 52 45
 CTION 0 Q    43 54 49 4F 4E 20 30 0D 0A 47
 AP 3.00 mm   41 50 20 33 2E 30 30 20 6D 6D
 .0.00 mm    2C 30 2E 30 30 20 6D 6D 0D 0A
 REFERENCE    52 45 46 45 52 45 4E 43 45 20
 0.0 SET C    30 2C 30 0D 0A 53 45 54 20 43
 UTTER OFF    55 54 54 45 52 20 4F 46 46 0D
 SIZE 100.    0A 53 49 5A 45 20 31 30 30 2E
 02 mm,65.0  30 32 20 6D 6D 2C 36 35 2E 30
 4 mm CLS    34 20 6D 6D 0D 0A 43 4C 53 0D
 BARCODE 1    0A 42 41 52 43 4F 44 45 20 31
 44.149,"39  34 34 2C 31 34 39 2C 22 33 39
 ",120,1,0.   22 2C 31 32 30 2C 31 2C 30 2C
 2.6,"57114  32 2C 36 2C 22 35 37 31 31 34
 38T" PRIN   33 38 54 22 0D 0A 50 52 49 4E
 T 1,1 SPE   54 20 31 2C 31 0D 0A 53 50 45
 ED 2.0 DE   45 44 20 32 2E 30 0D 0A 44 45
 NSITY 8 S   4E 53 49 54 59 20 38 0D 0A 53

ET PEEL OF    45 54 20 50 45 45 4C 20 4F 46
 F DIRECTI    46 0D 0A 44 49 52 45 43 54 49
 ON 0 GAP     4F 4E 20 30 0D 0A 47 41 50 20
 3.00 mm,0.   33 2E 30 30 20 6D 6D 2C 30 2E
 00 mm REF    30 30 20 6D 6D 0D 0A 52 45 46
 ERENCE 0.0   45 52 45 4E 43 45 20 30 2C 30
 SET CUTT     0D 0A 53 45 54 20 43 55 54 54
 ER OFF SI    45 52 20 4F 46 46 0D 0A 53 49
 ZE 100.02    5A 45 20 31 30 30 2E 30 32 20
 mm,65.04 m   6D 6D 2C 36 35 2E 30 34 20 6D
 m CLS BA     6D 0D 0A 43 4C 53 0D 0A 42 41
 RCODE 144.   52 43 4F 44 45 20 31 34 34 2C
 149,"39",1   31 34 39 2C 22 33 39 22 2C 31
 20,1,0,2,6   32 30 2C 31 2C 30 2C 32 2C 36
 ,"5711438T   2C 22 35 37 31 31 34 33 38 54
 " PRINT 1    22 0D 0A 50 52 49 4E 54 20 31
 ,1           2C 31 0D 0A

```

## Dump mode printout

Note :

Turn off and on the power switch to reset the printer for normal printing.



### 4.3 Printer Initialization

Printer initialization is used to clear DRAM and restore printer settings to defaults. The only one exception is ribbon sensitivity, which will not be restored to default.

Printer initialization is activated by the following procedures.

1. Turn off the power switch.
2. Hold on the button then turn on the power switch.
3. Release the button when LED turns **green** after 5 amber blinks. (Any green will do during the 5 blinks).
  - The LED color will be changed as following:  
Amber → red (5 blinks) → amber (5 blinks) → **green (5 blinks)** → green/amber (5 blinks) → red/amber (5 blinks) → solid green

Printer configuration will be restored to defaults as below after initialization.

Parameter	Default setting
Speed	127 mm/sec (5 ips)
Density	8
Label Width	4" (101.6 mm)
Label Height	4" (101.6 mm)
Media Sensor Type	Gap sensor
Gap Setting	0.12" (3.0 mm)
Print Direction	0
Reference Point	0,0 (upper left corner)
Offset	0
Tear Mode	On
Peel off Mode	Off
Cutter Mode	Off
Serial Port Settings	9600 bps, none parity, 8 data bits, 1 stop bit
Code Page	850
Country Code	001
Clear Flash Memory	No
IP Address	DHCP

**Note :**

**Always do gap/black mark sensor calibration after printer initialization.**

#### 4.4 Set Black Mark Sensor as Media Sensor and Calibrate the Black Mark Sensor

Please follow the steps as below.

1. Turn off the power switch.
2. Hold on the button then turn on the power switch.
3. Release the button when LED turns **green/amber** after 5 green blinks. (Any green/amber will do during the 5 blinks).
  - The LED color will be changed as following:  
Amber → red (5 blinks) → amber (5 blinks) → green (5 blinks) → **green/amber (5 blinks)** → red/amber (5 blinks) → solid green

#### 4.5 Set Gap Sensor as Media Sensor and Calibrate the Gap Sensor

Please follow the steps as below.

1. Turn off the power switch.
2. Hold on the button then turn on the power switch.
3. Release the button when LED turns **red/amber** after 5 green/amber blinks. (Any red/amber will do during the 5 blinks).
  - The LED color will be changed as following:  
Amber → red (5 blinks) → amber (5 blinks) → green (5 blinks) → green/amber (5 blinks) → **red/amber (5 blinks)** → solid green

#### 4.6 Skip AUTO.BAS

TSPL2 programming language allows user to download an auto execution file to flash memory. Printer will run the AUTO.BAS program immediately when turning on printer power. The AUTO.BAS program can be interrupted without running the program by the power-on utility.

Please follow the steps as below.

1. Turn off printer power.
2. Press the FEED button and then turn on power.
3. Release the FEED button when LED becomes **solid green**.
  - The LED color will be changed as following:  
Amber → red (5 blinks) → amber (5 blinks) → green (5 blinks) → green/amber (5 blinks) → red/amber (5 blinks) → **solid green**
4. Printer will be interrupted to run the AUTO.BAS program.

## 5. Maintenance

### 5.1 Cleaning

This session presents the clean tools and methods to maintain your printer.

- Please use one of following material to clean the printer.
- Cotton swab (Head cleaner pen)
- Lint-free cloth
- Vacuum / Blower brush
- 100% ethanol
- The cleaning process is described as following

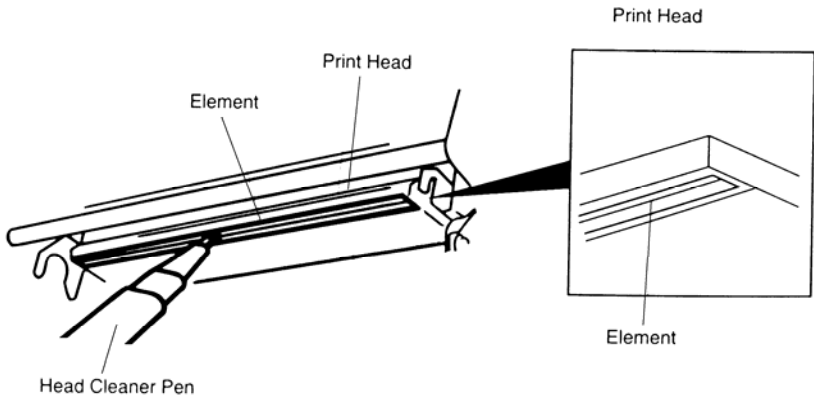
Printer Part	Method	Interval
<b>Print Head</b>	<ol style="list-style-type: none"> <li>1. Always turn off the printer before cleaning the print head.</li> <li>2. Allow the print head to cool for a minimum of one minute.</li> <li>3. Use a cotton swab (Head cleaner pen) and 100% ethanol to clean the print head surface.</li> </ol>	Clean the print head when changing a new label roll
	 <p>The diagram illustrates the cleaning process for the print head. It shows a hand holding a 'Head Cleaner Pen' and applying it to the 'Print Head' surface. The 'Print Head' is shown with multiple 'Element's. A callout box provides a magnified view of the 'Print Head' and 'Element' area.</p>	
<b>Platen Roller</b>	<ol style="list-style-type: none"> <li>1. Turn the power off.</li> <li>2. Rotate the platen roller and wipe it thoroughly with 100% ethanol and a cotton swab, or lint-free cloth.</li> </ol>	Clean the platen roller when changing a new label roll
<b>Tear Bar/Peel Bar</b>	Use the lint-free cloth with 100% ethanol to wipe it.	As needed
<b>Sensor</b>	Compressed air or vacuum	Monthly
<b>Exterior</b>	Wipe it with water-dampened	As needed

	cloth	
<b>Interior</b>	Brush or vacuum	As needed

**Note:**

- **Do not touch printer head by hand. If you touch it careless, please use ethanol to clean it.**
- **Please use 100% Ethenol. DO NOT use medical alcohol, which may damage the printer head.**
- **Regularly clean the print head and supply sensors once change a new ribbon to keep printer performance and extend printer life.**

## 6. Troubleshooting

The following guide lists the most common problems that may be encountered when operating this bar code printer. If the printer still does not function after all suggested solutions have been invoked, please contact the Customer Service Department of your purchased reseller or distributor for assistance.

### ● LED Status

This section lists the common problems that according to the LED status and other problems you may encounter when operating the printer. Also, it provides solutions.

LED Status / Color	Printer Status	Possible Cause	Recovery Procedure
OFF	No response	No power	<ul style="list-style-type: none"> <li>* Turn on the power switch.</li> <li>* Check if the green LED is lit on power supply. If it is not lit on, power supply is broken.</li> <li>* Check both power connections from the power cord to the power supply and from the power supply to the printer power jack if they are connected securely.</li> </ul>
Solid Green	ON	The printer is ready to use	* No action necessary.
Green with blinking	Pause	The printer is paused	* Press the FEED button to resume for printing.
Red with blinking	Error	The out of label or the printer setting is not correct	<ol style="list-style-type: none"> <li>1. Out of label               <ul style="list-style-type: none"> <li>* Load a roll of label and follow the instructions in loading the media then press the FEED button to resume for printing.</li> </ul> </li> <li>2. Printer setting is not correct               <ul style="list-style-type: none"> <li>* Initialize the printer by instructions in "Power on Utility" or "Diagnostic Tool".</li> </ul> </li> </ol>

**Note:**

**Printer status can be easily shown on the Diagnostic Tool. For more information about the Diagnostic Tool, please refer to the instruction in the software CD disk.**

● **Print Quality**

<b>Problem</b>	<b>Possible Cause</b>	<b>Recovery Procedure</b>
<b>Not Printing</b>	Check if interface cable is well connected to the interface connector.	Re-connect cable to interface.
	The serial port cable pin configuration is not pin to pin connected.	Please replace the cable with pin to pin connected.
	The serial port setting is not consistent between host and printer.	Please reset the serial port setting.
	The port specified in the Windows driver is not correct.	Select the correct printer port in the driver.
	The Ethernet IP, subnet mask, gateway is not configured properly.	Configure the IP, subnet mask and gateway.
<b>No print on the label</b>	Label loaded not correctly.	Follow the instructions in loading the media.
<b>Continuous feeding labels</b>	The printer setting may go wrong.	Please do the initialization and gap/black mark calibration.
<b>Paper Jam</b>	Gap/black mark sensor sensitivity is not set properly (sensor sensitivity is not enough)	Calibrate the gap/black mark sensor.
	Make sure label size is set properly.	Set label size exactly as installed paper in the labeling software or program.
	Labels may be stuck inside the printer mechanism near the sensor area.	Remove the stuck label.
<b>Poor Print Quality</b>	Top cover is not closed properly.	Close the top cover completely and make sure the right side and left side levers are latched properly.
	Check if supply is loaded correctly.	Reload the supply.
	Media are incompatible.	Change the label combination.
	Check if dust or adhesives are accumulated on the print head.	Clean the print head.
	Check if print density is set properly.	Adjust the print density and print speed.
	Check print head test pattern if head element is damaged.	Run printer self-test and check the print head test pattern if there is dot missing in the pattern.

## 7. LED and Button Operation

This printer has one button and one three-color LED indicator. By indicating the LED with different color and pressing the button, printer can feed labels, pause the printing job, select and calibrate the media sensor, print printer self-test report, reset printer to defaults (initialization). Please refer to the button operation below for different functions.

### 7.1 LED

LED Color	Description
Green/ Solid	This illuminates that the power is on and the device is ready to use.
Green/ Flash	This illuminates that the system is downloading data from PC to memory and the printer is paused.
Amber	This illuminates that the system is clearing data from printer.
Red / Solid	This illuminates printer head open, cutter error.
Red / Flash	This illuminates a printing error, such as head open, paper empty, paper jam, or memory error etc.

### 7.2 Button Operation

<b><i>Feed</i></b>	<ul style="list-style-type: none"><li>● Press the button when the LED is <b>green</b>.<ul style="list-style-type: none"><li>■ It feeds the label to the beginning of the next label.</li></ul></li></ul>
<b><i>Pause</i></b>	<ul style="list-style-type: none"><li>● Press the feed button during printing.<ul style="list-style-type: none"><li>■ The printing job is suspended.</li></ul></li></ul>

<p><b>Gap/Black Mark Sensor Calibration</b></p>	<p>1. Turn off the power switch.  2. Hold on the button then turn on the power switch.  3. Release the button when LED becomes <b>red</b> and blinking.  (Any red will do during the 5 blinks).</p> <ul style="list-style-type: none"> <li>■ It will calibrate the gap/black mark sensor sensitivity.</li> <li>■ The LED color will be changed as following order :  Amber → <b>red (5 blinks)</b> → amber (5 blinks) → green  (5 blinks) → green/amber (5 blinks) → red/amber (5  blinks) → solid green</li> <li>■ It calibrates the sensor and measures the label length.</li> </ul> <p><b>Note:</b>  <b>Please select gap or black mark sensor by GAP or BLINE  command prior to calibrate the sensor.</b>  <b>For more information about GAP and BLINE command,  please refer to TSPL2 programming manual.</b></p>
<p><b>Gap/Black Mark Sensor Calibration, Label Length Measurement, Self Test and enter Dump Mode</b></p>	<p>1. Turn off the power switch.  2. Hold on the button then turn on the power switch.  3. Release the button when LED becomes <b>amber</b> and blinking.  (Any amber will do during the 5 blinks).</p> <ul style="list-style-type: none"> <li>■ The LED color will be changed as following order.  Amber → red (5 blinks) → <b>amber (5 blinks)</b> → green  (5 blinks) → green/amber (5 blinks) → red/amber (5  blinks) → solid green</li> <li>■ It calibrates the sensor and measures the label length  and prints internal settings then enter the dump mode.</li> </ul> <p><b>Note:</b>  <b>Please select gap or black mark sensor by GAP or BLINE  command prior to calibrate the sensor.</b>  <b>For more information about GAP and BLINE command,  please refer to TSPL2 programming manual.</b></p>



<p><b>Printer Initialization</b></p>	<ol style="list-style-type: none"> <li>1. Turn off the power switch.</li> <li>2. Hold on the button then turn on the power switch.</li> <li>3. Release the button when LED turns <b>green</b> after 5 amber blinks. (Any green will do during the 5 blinks). <ul style="list-style-type: none"> <li>■ The LED color will be changed as following: Amber → red (5 blinks) → amber (5 blinks) → <b>green (5 blinks)</b> → green/amber (5 blinks) → red/amber (5 blinks) → solid green</li> </ul> </li> </ol> <ul style="list-style-type: none"> <li>● Always do <b>gap/black mark sensor calibration</b> after printer initialization.</li> </ul>
<p><b>Set Black Mark Sensor as Media Sensor and Calibrate the Black Mark Sensor</b></p>	<ol style="list-style-type: none"> <li>1. Turn off the power switch.</li> <li>2. Hold on the button then turn on the power switch.</li> <li>3. Release the button when LED turns <b>green/amber</b> after 5 green blinks. (Any green/amber will do during the 5 blinks). <ul style="list-style-type: none"> <li>■ The LED color will be changed as following: Amber → red (5 blinks) → amber (5 blinks) → green (5 blinks) → <b>green/amber (5 blinks)</b> → red/amber (5 blinks) → solid green</li> </ul> </li> </ol>
<p><b>Set Gap Sensor as Media Sensor and Calibrate the Gap Sensor</b></p>	<ol style="list-style-type: none"> <li>1. Turn off the power switch.</li> <li>2. Hold on the button then turn on the power switch.</li> <li>3. Release the button when LED turns <b>red/amber</b> after 5 green/amber blinks. (Any red/amber will do during the 5 blinks). <ul style="list-style-type: none"> <li>■ The LED color will be changed as following: Amber → red (5 blinks) → amber (5 blinks) → green (5 blinks) → green/amber (5 blinks) → <b>red/amber (5 blinks)</b> → solid green</li> </ul> </li> </ol>

<b>Skip AUTO.BAS</b>	<ol style="list-style-type: none"><li>1. Turn off printer power.</li><li>2. Press the FEED button and then turn on power.</li><li>3. Release the FEED button when LED becomes <b>solid green</b>.<ul style="list-style-type: none"><li>■ The LED color will be changed as following: Amber → red (5 blinks) → amber (5 blinks) → green (5 blinks) → green/amber (5 blinks) → red/amber (5 blinks) → <b>solid green</b></li></ul></li><li>4. Printer will be interrupted to run the AUTO.BAS program.</li></ol>
----------------------	--------------------------------------------------------------------------------------------------------------------------------------------------------------------------------------------------------------------------------------------------------------------------------------------------------------------------------------------------------------------------------------------------------------------------------------------------------------------------------------------------------------------

## Revise History

Date	Content	Editor
2008/2/29	* Revise the section 3.8: Internal Ethernet Print Server Module Installation (Option) * Add section 3.9: Diagnostic Tool *.Add the IP Address default setting	Camille
2008/3/5	*.Add section 3.10: Install Memory Card *.Revise the sections 3.3 and 3.8. *.Revise the default setting.	Camille
2008/3/6	Revise the section 2.2	Camille
2008/3/7	Revise the sections 4.2 & 5.1	Camille
2008/3/10	Revise the section 6	Camille
2008/11/18	Revise section 3.5	Camille
2009/3/11	Revise section 3.10 (Recommended SD card specification)	Camille
2009/6/19	Revise compliances section	Camille
2009/10/14	* Revise section 3.9 * Add section 3.10	Camille
2009/12/3	Add TDP-247 and TDP-345 model	Camille
2010/3/5	* Revise compliances section * Revise section 3.1	Camille
2010/7/28	Revise section 2.3.2	Camille
2010/8/13	Revise compliances section	Camille
2011/1/14	Remove internal Ethernet print server module installation section	Camille
2011/1/25	Modify TSC address	Camille

**Avery Weigh-Tronix**

Avery Weigh-Tronix USA  
1000 Armstrong Drive  
Fairmont MN 56031 USA  
TEL: 507-238-4461  
FAX: 507-238-4195  
E-mail: [usinfo@awtxglobal.com](mailto:usinfo@awtxglobal.com)  
Website [www.wtxweb.com](http://www.wtxweb.com)

Avery Weigh-Tronix UK  
Foundry Lane  
Smethwick, West Midlands  
England B66 2LP  
TEL: +44(0) 8453 66 77 888183  
FAX: +44(0) 121 224  
E-mail: [info@awtxglobal.com](mailto:info@awtxglobal.com)  
[www.averyweigh-tronix.com](http://www.averyweigh-tronix.com)