

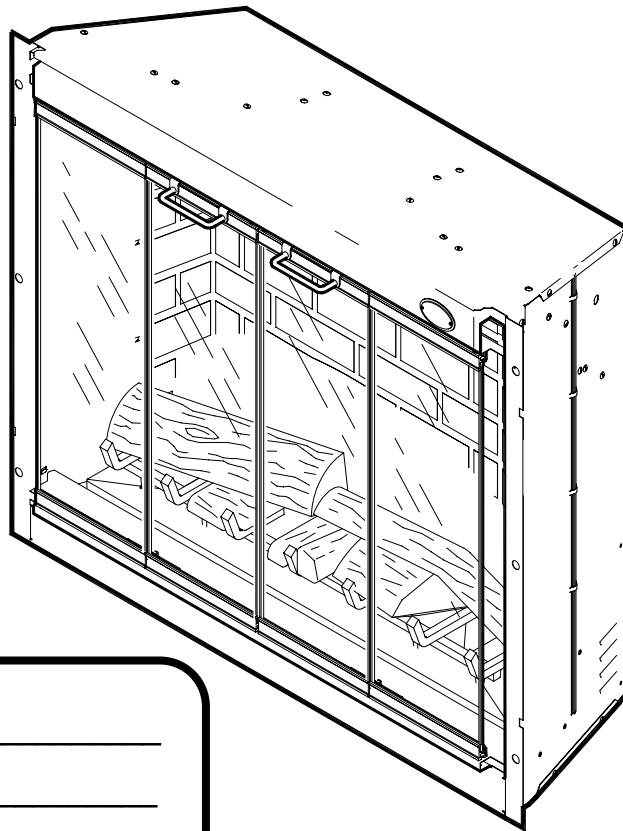

PRACTICAL USER'S GUIDE FOR THE DIMPLEX MULTIFIRE™ ELECTRIC FIREPLACE

MODEL NUMBER: DF3215



Serial Number _____

Model Number _____

CAT Number _____

Quality checked by:

Valued Customer,

We are pleased that you have chosen to purchase an electric fireplace manufactured by Dimplex North America Ltd.

Over the years, valuable memories will occur around the warmth and comfort of your hearth. Thank you for allowing our product to be the backdrop for those special moments.

QUICK REFERENCE GUIDE FOR THE DIMPLEX ELECTRIC FIREPLACE

- 1. Prior to the first use of the fireplace verify the following:**
 - **Are the circuit breakers for the socket the unit uses on?**
 - **Are the light bulbs in your fireplace loose? (to check, follow the instructions for replacing the light bulbs under the maintenance section of this manual)**

- 2. The heater on your fireplace may emit a slight, harmless odor when first used. This odor is a normal condition caused by the initial heating of internal heater parts and will not occur again.**

- 3. The information regarding the model of your fireplace can be found on the rating plate. See Page 2 for location.**

- 4. If you have any technical questions regarding the operation or service of your fireplace have your Model and Serial Number ready, and contact Dimplex North America technical support at 1-888-DIMPLEX (1-888-346-7539) before returning the product to the point of purchase.**

CONTENTS

PAGE 1	Important Instructions
PAGE 2	Model and Serial Number Information
PAGE 3	Site Selection and Preparation
PAGE 4	Fireplace Installation
PAGE 5	Operation
PAGE 13	Maintenance
PAGE 16	Warranty

IMPORTANT INSTRUCTIONS

SAVE THESE INSTRUCTIONS

PLEASE RETAIN THIS USER'S GUIDE FOR FUTURE REFERENCE

When using electrical appliances, basic precautions should always be followed to reduce the risk of fire, electric shock, and injury to persons, including the following:

1. Read all instructions before using the electric fireplace.
2. The heater is hot when in use. To avoid burns, do not let bare skin touch hot surfaces. The trim around the heater outlet becomes hot during heater operation. Keep combustible materials, such as furniture, pillows, bedding, papers, clothes, and curtains at least 3 feet (0.9m) from the front of the unit.
3. Extreme caution is necessary when any heater is used by or near children or invalids and whenever the unit is left operating and unattended.
4. Always unplug the electric fireplace when not in use.
5. Do not operate any unit with a damaged cord or plug, or if the heater has malfunctioned, or if the electric fireplace has been dropped or damaged in any manner. Return heater to authorized service facility for examination, electrical or mechanical adjustment, or repair.
6. Do not use outdoors.
7. The electric fireplace is not intended for use in bathrooms, laundry areas and similar indoor locations. Never locate heater where it may fall into a bathtub or other water container.
8. Do not run the cord under carpeting. Do not cover cord with throw rugs, runners, or the like. Arrange cord away from traffic area and where it will not be tripped over.
9. To disconnect the unit, turn the controls off, then remove the plug from the outlet.
10. Do not insert or allow foreign objects to enter any ventilation or exhaust opening as this may cause an electric shock or fire, or damage to the heater.
11. To prevent a possible fire, do not block air intake or exhaust in any manner. Do not use on soft surfaces, like a bed, where openings may become blocked.
12. All electrical heaters have hot and arcing or sparking parts inside. Do not use in areas where gasoline, paint, or flammable liquids are used or stored or where the unit will be exposed to flammable vapors.
13. Do not modify the electric fireplace. Use it only as described in this manual. Any other use not recommended by the manufacturer may cause fire, electric shock or injury to persons.
14. Avoid the use of an extension cord. Extension cords may overheat and cause a risk of fire. If you must use an extension cord, the cord must be No. 16 AWG minimum size and rated no less than 1875 watts.
15. Do not burn wood or other materials in the electric fireplace.
16. Do not strike the fireplace glass.
17. Always use a certified electrician should new circuits or outlets be required.
18. Always use properly grounded, fused and polarized outlets.
19. Disconnect all power supply before performing any cleaning, maintenance or relocation of the unit.
20. When transporting or storing the unit and cord, keep in a dry place, free from excessive vibration and store so as to avoid damage.

NOTE: Procedures and techniques that are considered important enough to emphasize.

CAUTION: Procedures and techniques which, if not carefully followed, will result in damage to the equipment.

WARNING: Procedures and techniques which, if not carefully followed, will expose the user to the risk of fire, serious injury, illness or death.

IMPORTANT INSTRUCTIONS

If you have any questions regarding our products please have the product model and serial numbers available upon calling Dimplex customer service or technical support. To locate the model and serial number labels see below. Record the Model number, Serial number, and CAT number on the front cover of this manual for future reference.

Model Number

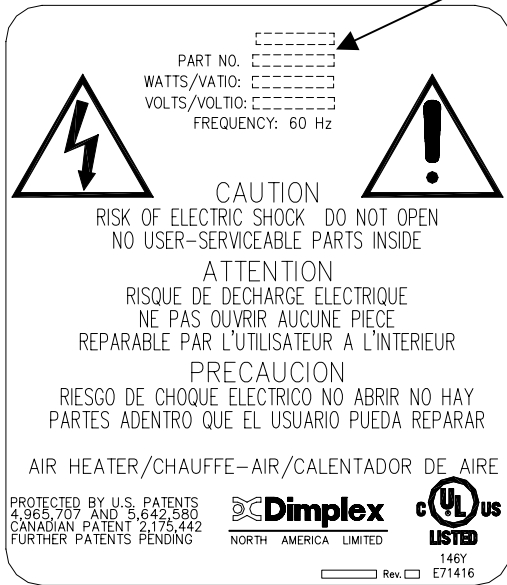

Serial Number

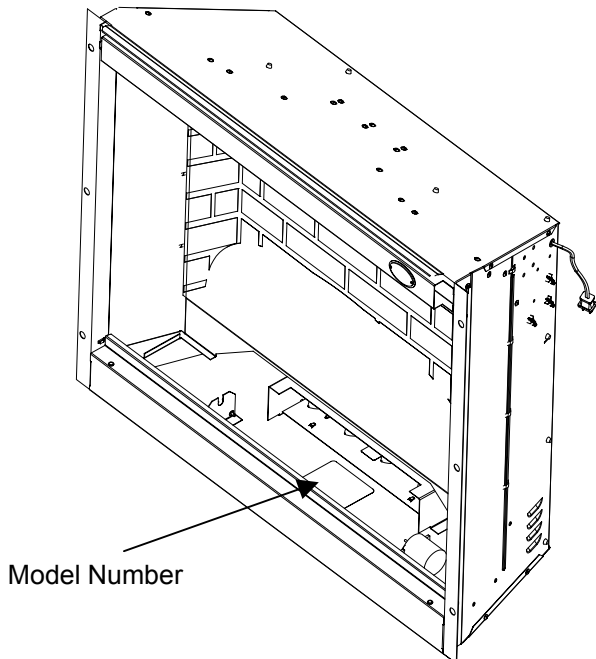
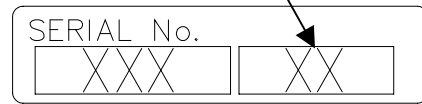

Serial Number

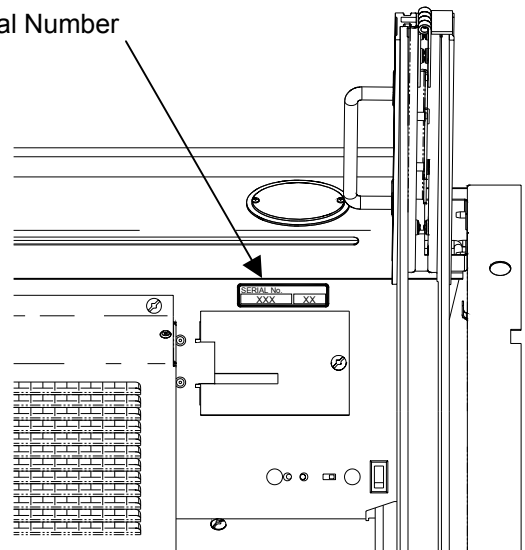

Firebox

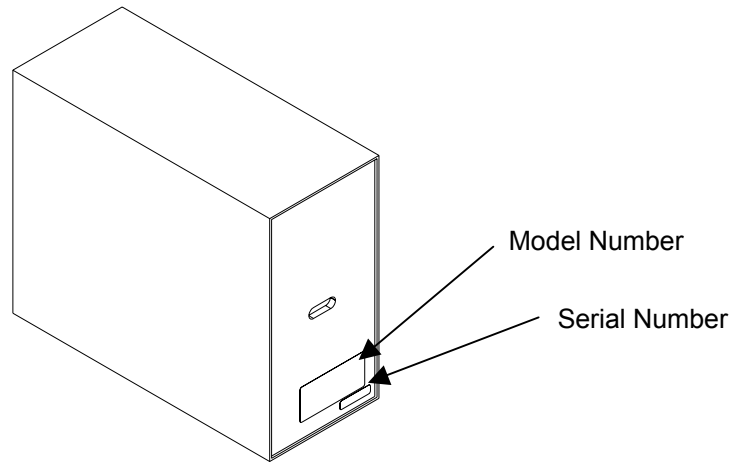

Carton

NOTE 1

A 15amp, 120 volt circuit is required. A dedicated circuit is preferred but not essential in all cases. A dedicated circuit will be required if, after installation, the circuit breaker trips or fuse blows on a regular basis when the heater is operating. Additional appliances on the same circuit may exceed the current rating of the circuit breaker.

WARNING

Ensure the power cord is not installed so that it is pinched or against a sharp edge and ensure that the power cord is stored or secured to avoid tripping or snagging to reduce the risk of fire, electric shock or injury to persons.

Construction and electrical outlet wiring must comply with local building codes and other applicable regulations to reduce the risk of fire, electric shock and injury to persons.

Do not attempt to wire your own new outlets or circuits. To reduce the risk of fire, electric shock or injury to persons, always use a licensed electrician.

SITE SELECTION AND PREPARATION

This section provides instructions for selecting a location and preparing the site to install the fireplace into your Dimplex mantel surround.

1. Select a suitable location that is not susceptible to moisture and is away from drapes, furniture and high traffic.
2. For ease of electrical hook up you may wish to locate the fireplace near an existing outlet. (refer to NOTE 1)
3. Store the fireplace in a safe dry and dust free location.

NOTE

The dimensions of the fireplace are 36 ½" wide X 31 ¾" high X 13" deep. The viewing area is 32" wide and 28 ¼" high. The fireplace does not require any additional venting.

FIREPLACE INSTALLATION

1. Install the Bi-fold doors to the fireplace.

IMPORTANT

Bi-fold doors **MUST** be installed to the firebox prior to installing firebox to mantel.

BI-FOLD DOOR INSTALLATION

1. Remove the bi-fold doors from packaging.
2. Remove the Philips head screw and the door spacer from the bottom edge of the bi-fold door opposite of the door handle.
3. Insert the door spacer into the bottom panel ledge mounting hole.
4. Insert the top edge of the bi-fold door into the top door track on the fireplace.
5. Secure the bi-fold door to unit with supplied screw using a short handled screwdriver.

NOTE

If short handled screwdriver is not available tilt the unit back.

6. Repeat steps 2-5 for the other side.

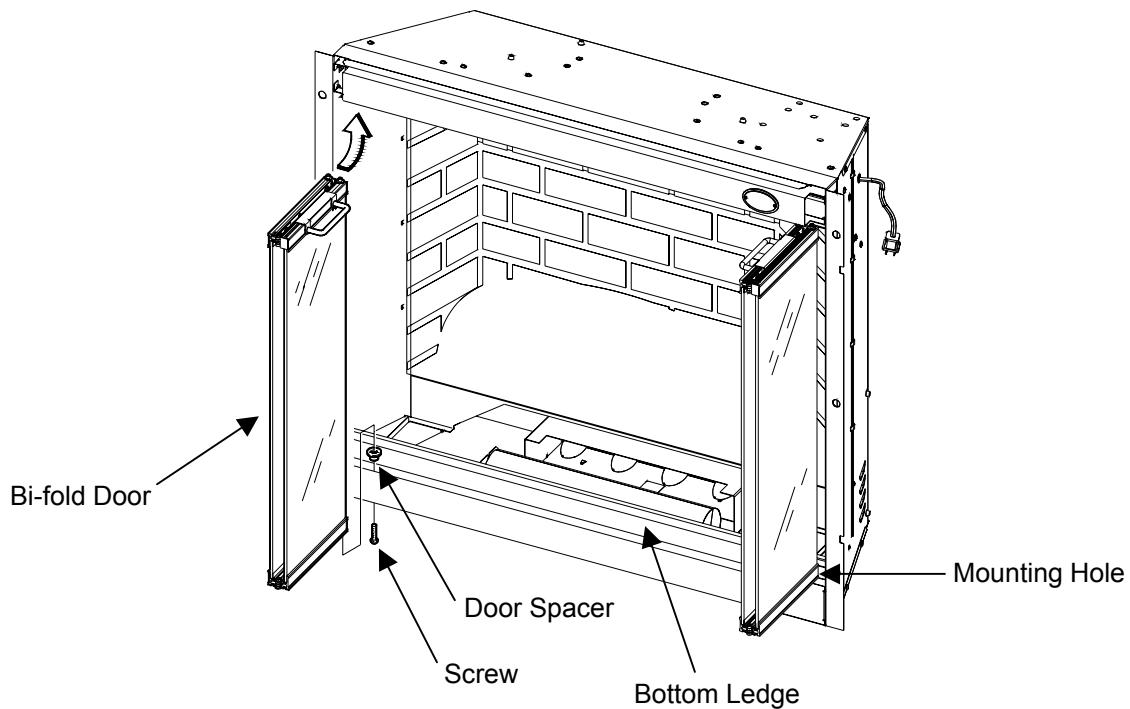
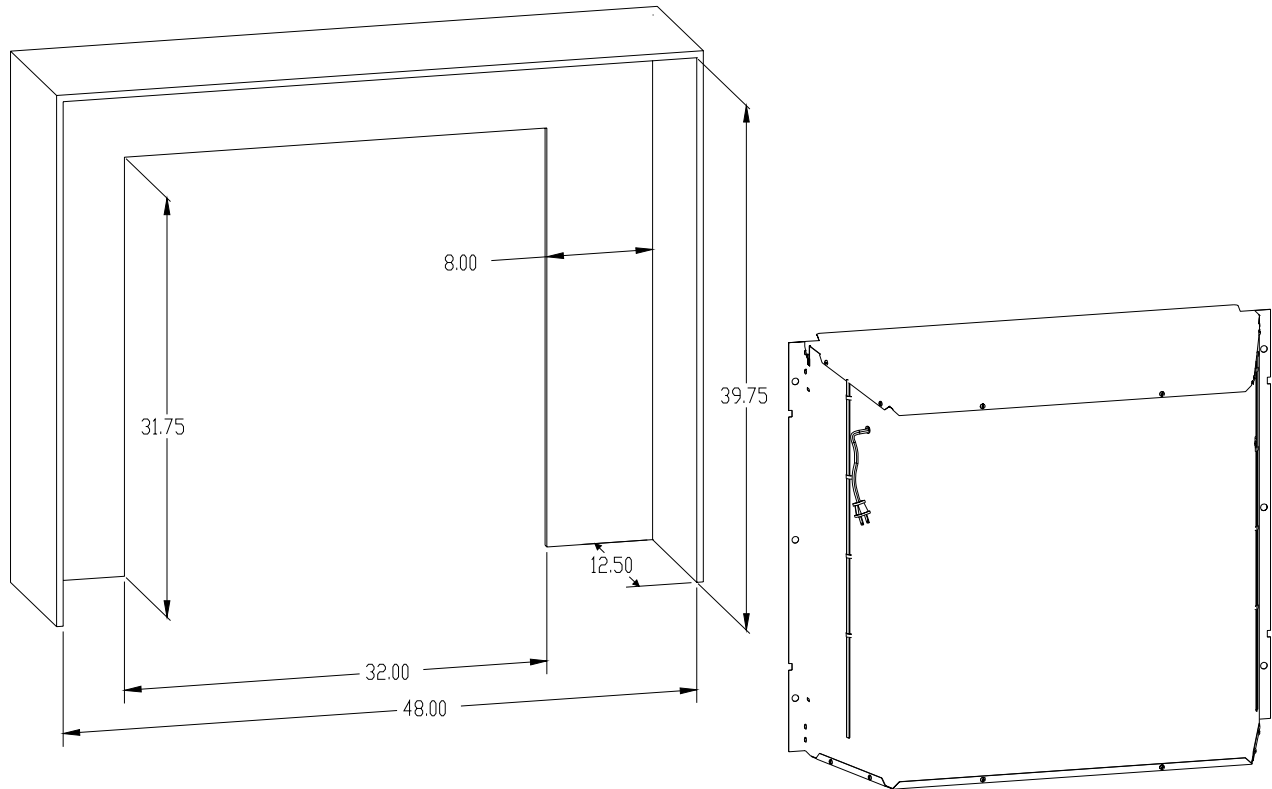

FIGURE 1

2. Install the fireplace assembly into the mantel. (refer to mantel assembly instructions)

IMPORTANT

If not using a Dimplex mantel, the fireplace must be installed in an enclosure with the following **MINIMUM** internal/opening dimensions.



3. Ensure the MANUAL CONTROL on the unit is in the **Remote** position (left position). (refer to electric fireplace manual control instruction section)
4. Plug the unit into a 15Amp/120Volt outlet. If the cord does not reach, you may use an extension cord rated for a minimum of 1875 watts.

WARNING

Ensure the power cord is not installed so that it is pinched or against a sharp edge. Also ensure the power cord is stored or secured to avoid tripping or snagging to reduce the risk of fire, electric shock or injury to persons.

OPERATION

ELECTRIC FIREPLACE MANUAL CONTROL

The manual controls for the fireplace are located in the upper right hand corner.

A. Main On/Off Switch

Supplies power to the 3 position manual control switch.

B. 3 Position Manual Control Switch

Remote (left position): The unit is operated with the remote control.

Flame (center position): The flame effect is turned ON.

Flame & Heat (right position): The flame effect and heater are turned ON simultaneously. When the manual control is in the **Flame & Heat** position the heater does not run on the remote operated thermostat. When the heater is ON the red indicator light is activated on the firebox and the fan and heater are running on low.

NOTE

When the manual control switch is in the **Flame** and **Flame & Heat** positions, the fireplace unit will not operate with the remote control.

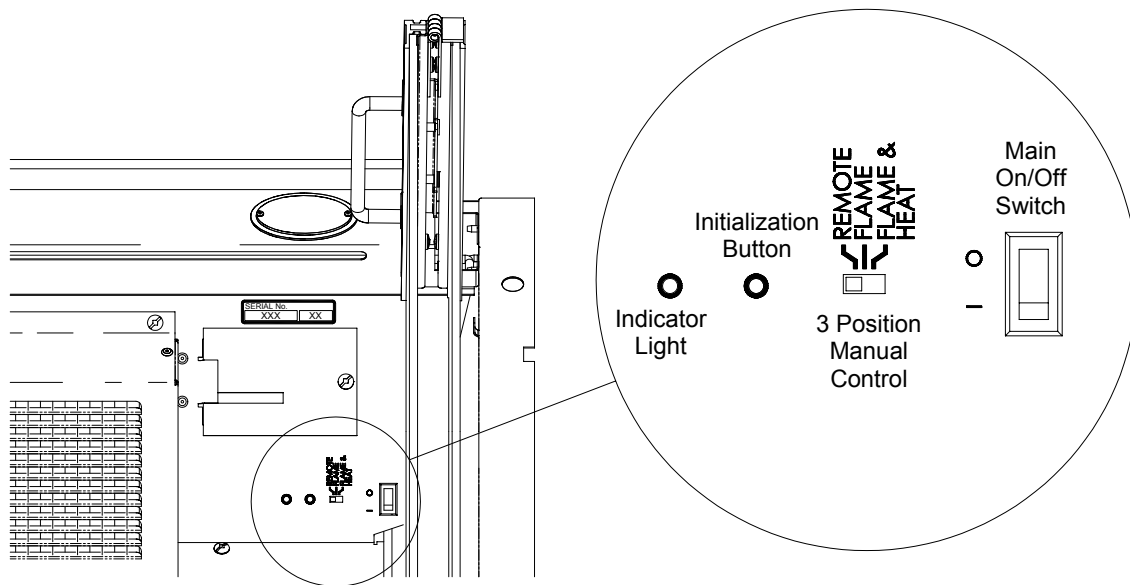

FIGURE 2

RESETTING THE TEMPERATURE CUTOFF SWITCH

Should the heater overheat, an automatic switch will turn the heater off and it will not come back on without being reset. The temperature cutoff switch can be reset by unplugging the unit, waiting 5 minutes and plugging the unit back in.

CAUTION

If you need to continuously reset the heater, unplug the unit and call Dimplex North America Limited at 1-800-668-6663 and press 4 for technical support.

REMOTE CONTROL

The remote control has a range of approximately 50 ft. (15.25m), it does not have to be pointed at the fireplace and can pass through most obstacles (including walls). It is supplied with 243 independent frequencies to prevent interference with other units.

BATTERY INSTALLATION

1. Depress tab on the battery cover on the back of the remote transmitter and remove battery cover.
2. Install 3 AAA batteries into the remote control. (included)
3. Replace the battery cover.

NOTE

The remote transmitter has a battery backup time of 24 hours. The batteries can be removed for up to 24 hours before the transmitter will require re-initialization.

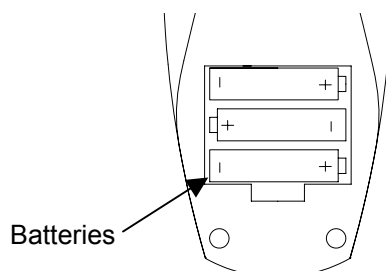







FIGURE 3

NOTE

When the **Low Battery** icon  is present on the remote control it is recommended to replace the batteries promptly, to maintain full functionality of the remote/fireplace (FIGURE 5).

INITIALIZING THE REMOTE CONTROL

1. Plug cord into 120 volt wall outlet.
2. Turn ON the electrical power at the circuit breaker.
3. Ensure the Main On/Off switch located inside the fireplace in the upper right hand corner is in the **ON** position.
4. Set the 3 position manual control to the **Remote** position (left position).
5. Press and hold the initialization button on the unit.
6. While holding the initialization button, press the flame/heat ON/OFF  button or the Purifire™ ON/OFF  button on the remote control transmitter.
7. Release the initialization button on the unit.
8. Press the Flame/Heat On/Off button  to turn the Flame/Heat function ON or press the Purifire™ On/Off button  to turn the Purifire™ function ON.

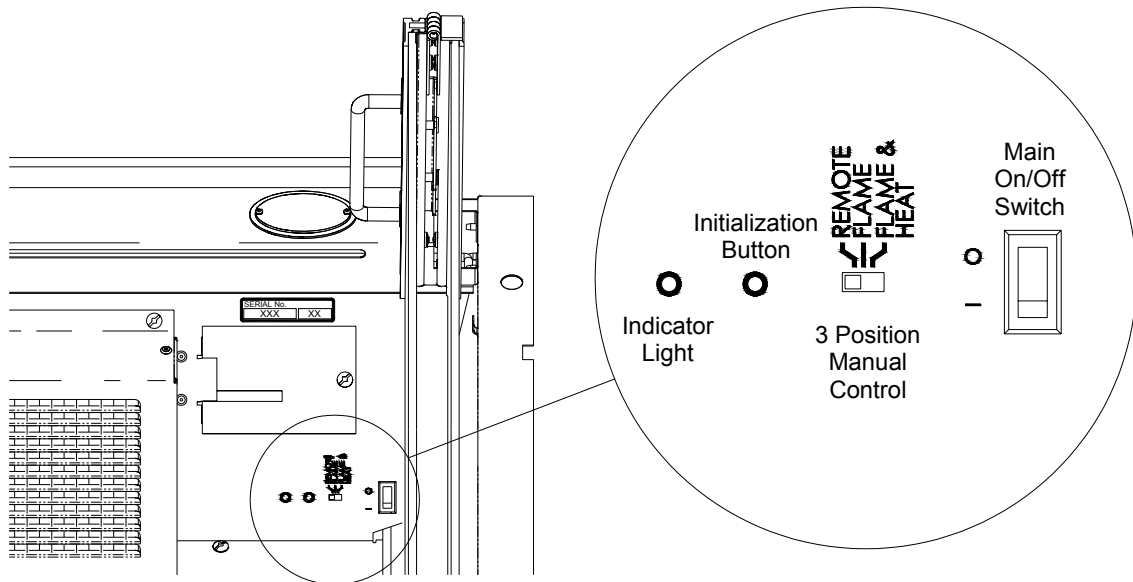







FIGURE 4

FREQUENCY INTERFERENCE

If the fireplace does not respond properly to the remote control, the remote operating frequency may have to be reset. The remote control can send another frequency code to the circuit board to eliminate interference.

1. Press the Flame/Heat On/Off button  to turn the Flame/Heat ON.
2. Press the ENTER button on the remote control, the middle display  flashes.
3. Use the direction buttons on the hand held remote to move the cursor to  and press ENTER.
4. Press and hold the initialization button on the unit.
5. Press and hold **←** left direction button on the remote control.
6. A descending bar graph will appear on the screen.
7. The green indicator light will flash on the unit when the new frequency code has been stored.
8. Release **←** left direction button on the remote control.
9. Release the initialization button on the unit.
10. Press ENTER to return to the main menu.
11. Press the Flame/Heat On/Off button  to turn the Flame/Heat function ON or press the Purifire™ On/Off button  to turn the Purifire™ function ON.

REMOTE CONTROL FUNCTIONS

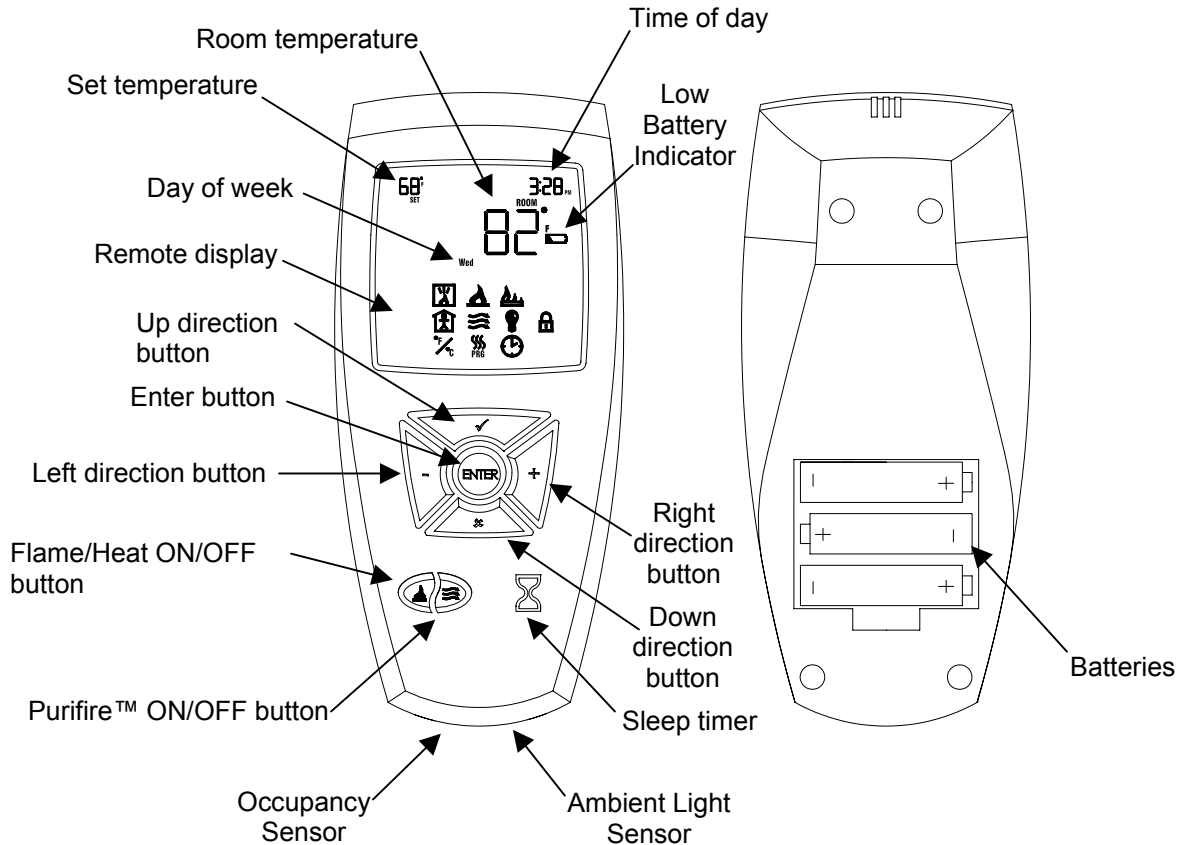





FIGURE 5



FLAME/HEAT ON/OFF BUTTON

Press the Flame/Heat On/Off button  to turn the Flame/Heat function ON. When the heater function is ON, the  icon is displayed on the remote control in the upper left hand corner. When this  icon is displayed, the red indicator light is activated on the firebox. The default temperature setting is 72°F (22°C). Press the Flame/Heat On/Off button  to turn the Flame/Heat function OFF.

NOTE

When using the remote control the heater runs on a thermostat. Press the **+** or **-** direction keys to adjust the set temperature. Once the desired set temperature is reached the heater will turn OFF. The heater will cycle ON and OFF to maintain the desired set temperature.

PURIFIRE ON/OFF BUTTON

Press the Purifire™ On/Off button  to turn the Purifire™ function ON. When the Purifire™ function is ON and the Heater  icon is **NOT** displayed on the remote control, the green indicator light is activated on the firebox. The default setting for the Purifire™ is set at low speed. Press the Purifire™ On/Off button  to turn the Purifire™ function OFF.

NOTE

To turn the Flame/Heat and Purifire™ ON or OFF at the same time, press both   control buttons simultaneously.

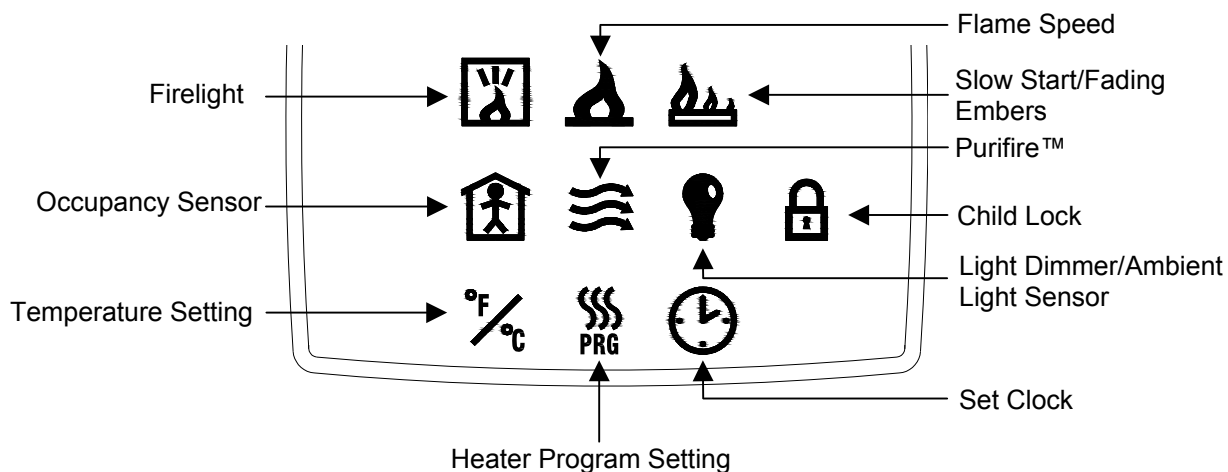





FIGURE 6



SET CLOCK

1. Press the ENTER button, the middle display  flashes.
2. Use the direction buttons on the hand held remote to move the cursor to the  clock and press the ENTER button.
3. A day of the week will flash.
4. Use the **-** left or **+** right direction button to select the day of the week.
5. Press the **✓** up direction button and the hour display will flash.
6. Use the **-** left or **+** right direction button to select the hour.
7. Press the **✓** up direction button and the minute display will flash.
8. Use the **-** left or **+** right direction button to select the minute.
9. Press ENTER to return to the main menu.



SET TEMPERATURE

1. Press the ENTER button, the middle display  flashes.
2. Use the direction buttons on the hand held remote to move the cursor to  and press ENTER.
3. Use the **-** left or **+** right direction button to select between °F and °C.
4. Press ENTER to return to the main menu.

FIRELIGHT

1. Press the Flame/Heat button  to turn the Flame/Heat ON.
2. Press the ENTER button, the middle display  flashes.
3. Use the direction buttons on the hand held remote to move the cursor to  and press ENTER.
4. Press the **✓** up direction button to turn the firelight ON, press the **✗** down direction button to turn the firelight OFF.
5. Press ENTER to return to the main menu.

FLAME SPEED



1. Press the Flame/Heat button  to turn the Flame/Heat ON.
2. Press the ENTER button, the middle display  flashes.
3. Use the direction buttons on the hand held remote to move the cursor to  and press ENTER.
4. Repeatedly press the **-** left or **+** right direction buttons to decrease or increase the flame speed.

NOTE

The bar graph located on the top of the display screen indicates the speed range of the flame.

5. Press ENTER to return to the main menu.

LIGHT DIMMER





1. Press the Flame/Heat button  to turn the Flame/Heat ON.
2. Press the ENTER button, the middle display  flashes.
3. Use the direction buttons on the hand held remote to move the cursor to  and press ENTER.
4. Repeatedly press the **−** left or **+** right direction button to decrease or increase the brightness of the upper lights.

NOTE

The bar graph located on the top of the display screen indicates the upper light brightness range.





AMBIENT LIGHT SENSOR

When the room gets darker the upper lights dim, allowing for a more desirable and realistic flame effect. The ambient light sensor is located in the bottom of the remote. (FIGURE 6)

1. Press the Flame/Heat button  to turn the Flame/Heat ON.
2. Press the ENTER button, the middle display  flashes.
3. Use the direction buttons on the hand held remote to move the cursor to  and press ENTER.
4. Press the  up direction button to turn the ambient light sensor ON, press the  down direction button to turn the ambient light sensor OFF.
5. Press ENTER to return to the main menu.

SLOW START/FADING EMBERS

The slow start function simulates a starting fire. The slow start function timer is automatically programmed for 30 seconds. The slow start timer setting cannot be changed. The fading embers function simulates a fire going out. The fading embers function timer can be set to 1, 5, or 10 minutes.





1. Press the ENTER button, the middle display  flashes.
2. Use the direction buttons on the hand held remote to move the cursor to  and press ENTER.
3. Press the **−** left or **+** right direction button to select 1, 5, or 10 minutes for the fading embers.
4. Press the  up direction button to turn the slow start/fading embers function ON, press the  down direction button to turn the slow start/fading embers function OFF.
5. Press ENTER to return to the main menu.
6. Press the Flame/Heat on/off  button to activate the slow start/fading embers.

NOTE





When turning the unit OFF with the slow start/fading ember function ON, the slow start/fading ember  indicator will flash for 1 minute.

OCCUPANCY SENSOR

The occupancy sensor function can be programmed to turn the fireplace ON when it detects movement. The occupancy sensor is programmed to turn the fireplace OFF when it doesn't detect movement in 5, 10, or 20 minutes. The occupancy sensor is located in the bottom of the remote. (FIGURE 6) The occupancy sensor has a range of 10 feet.

1. Press the ENTER button, the middle display  flashes.
2. Use the direction buttons on the hand held remote to move the cursor to  and press ENTER.
3. Press the **−** left or **+** right direction button to 5, 10, or 20 minutes.
4. Press the  up direction button to turn the occupancy sensor ON, press the  down direction button to turn the occupancy sensor OFF.
5. Press ENTER to return to the main menu.

CHILD LOCK







1. Press the ENTER button, the middle display  flashes.
2. Use the direction buttons on the hand held remote to move the cursor to  and press ENTER.
3. Press and hold the  up direction button for 4 – 5 seconds. The  will flash when the child lock function has been turned ON.
4. To turn the child lock function OFF, hold the  down direction button for 4 – 5 seconds.

PURIFIRE™

The Purifire™ includes a high efficiency filter to help improve the quality of air. When the Purifire™ function is ON and the Heater  icon is **NOT** displayed on the remote control, the green indicator light is activated on the firebox.

NOTE

The red indicator light overrides the green Purifire™ light.



1. Press the ENTER button until the middle display  flashes.
2. Press the ENTER button on the  Purifire™ function.
3. Press the  left or  right direction button to select LOW or HIGH.
4. Press the  up direction button to turn the Purifire™ ON, press the down  direction button to turn the Purifire™ OFF.
5. Press ENTER to return to the main menu.

NOTE

The Purifire™ can also be turned On/Off by pressing the  Purifire™ On/Off button.

SLEEP TIMER

The Sleep Timer automatically shuts off the fireplace after a preset time (from 30 minutes to 8 hours).

1. To set the sleep timer press the sleep timer  button.
2. Pressing the sleep timer button repeatedly will increase the sleep timer by 30 minute increments.
3. The fireplace will automatically turn OFF when the sleep timer reaches 0 minutes.
4. The sleep timer can be cancelled at any time by pressing the sleep timer  button repeatedly until the sleep timer display disappears and the room temperature display is shown.

PROGRAMMABLE HEATER SETTING

The heater thermostat can be programmed to suit your individual needs by using the **INDIVIDUAL DAY SETTING**. When going through the programmable heater setting for the first time the display screen on the remote will read — — : — — . The programmable heater has 2 program settings (P1 and P2). Program 1 (P1) is to be used for your comfortable room setting and Program 2 (P2) is to be used as your set back (energy-saving) temperature. Once the heater has been programmed and the program has been turned ON the temperature can only be changed by either turning the program OFF or by pressing the Flame/Heat  On/Off button. (see programming individual day setting section to turn program OFF and/or temporary manual override section)

NOTE

When the occupancy sensor function is ON, it will also override the programmable heater setting.

PERSONAL PROGRAM SCHEDULE



Before programming the heater use the personal program schedule below to determine which time and temperature settings meet your schedule.

Use a pencil to be able to revise your records each time you are required to change your program settings.

Day	Program 1 (P1)		Program 2 (P2)	
Mon.	Time	Temp	Time	Temp
Tues.	Time	Temp	Time	Temp
Wed.	Time	Temp	Time	Temp
Thurs.	Time	Temp	Time	Temp
Fri.	Time	Temp	Time	Temp
Sat.	Time	Temp	Time	Temp
Sun.	Time	Temp	Time	Temp









TEMPORARY MANUAL OVERRIDE

To temporarily change the current set temperature without affecting the current programs:

1. Press the Flame/Heat  On/Off button, the **PRG** display will disappear.
2. Press the **+** right or **-** left direction button to select the set temperature.
3. To cancel the temporary manual override press the Flame/Heat  On/Off button and the programmed settings will be reactivated.

PROGRAMMING INDIVIDUAL DAY SETTING

The **Individual Day** setting allows the user to program the heater thermostat to operate at a selectable time and temperature for each day of the week individually. (**Mon Tue Wed Thu Fri Sat Sun**)

1. Press the ENTER button, the middle display  flashes.
2. Use the direction buttons on the hand held remote to move the cursor to 
3. Press and hold ENTER for 4 – 5 seconds, **Mon** display will flash.
4. Press the **+** right or **-** left direction button to select the day of the week.
(**Mon Tue Wed Thu Fri Sat Sun**)
5. Press the  up direction button and the hour display to flash.
6. Press the **+** right or **-** left direction button to select the hour.
7. Press the  up direction button and the minute display will flash.
8. Press the **+** right or **-** left direction button to select the minute.
9. Press the  up direction button and the set temperature display will flash.
10. Press the **+** right or **-** left direction button to select the temperature setting.
11. Press the  up direction button and the P1 indicator will change to P2 and the hour display will flash.
12. Repeat steps 5 – 10 for the P2 setting.
13. Press the  up direction button and the individual day programmed will flash.
14. Press the **+** right direction button for each additional required program day.
15. Repeat steps 5 – 14 for the remaining individual days.
16. Press ENTER.
17. Press the  up direction button to turn the programmable heater function ON and press the  down direction button to turn the programmable heater function OFF.
18. Press ENTER to return to the main menu.

NOTE

When programmable heater function is **ON** the red indicator light is illuminated on the firebox and the **PRG** display will appear on the remote control.

NOTE

Press the ENTER button at any time to exit and return to the main menu.

MAINTENANCE

WARNING

Disconnect power before attempting any maintenance or cleaning to reduce the risk of fire, electric shock or damage to persons.

LIGHT BULB REPLACEMENT

Allow at least 5 minutes for light bulbs to cool before touching bulbs to avoid accidental burning of skin.

Light bulbs need to be replaced when you notice a dark section of the flame or when the clarity and detail of the log ember bed exterior disappears. There are four bulbs under the log set, which generate the flames and embers, and two bulbs above the log that illuminate the log exterior.

LOWER LIGHT BULB REQUIREMENTS

Quantity of 4 clear chandelier or candelabra bulbs with an E-12 (small) socket base, 60 watt rating. Example: GE 60BC or Philips 60 CTC.

DO NOT EXCEED 60 WATTS PER BULB

HELPFUL HINTS

It is a good idea to replace all light bulbs at one time if they are close to the end of their rated life. Group replacement will reduce the number of times you need to open the unit to replace light bulbs. Care must be taken when removing the logset as the logset contains LED's and wires.

To access the lower light bulb area:

1. Open the bi-fold doors.
2. Pull the front edge of the plastic ember bed or plastic grate up and forward until the rear tab releases from the ledge located at the bottom of the mirror.

IMPORTANT

ONLY handle the logset by the emberbed.

NOTE

Logset fits tightly into firebox, some force may be necessary to remove.

3. Set logset in front of firebox.
4. Disconnect the logset LED wire harness from unit.
5. Lift the left side of the flame rod out of the mounting bracket.
6. Examine the bulbs to determine which bulbs require replacement.
7. Unscrew bulbs counter clockwise.
8. Insert new bulbs.
9. Install the left side of the flame rod to the mounting bracket.
10. Reconnect the logset LED wire harness.
11. Replace the logset by inserting the front of the emberbed under the front edge of the fireplace and push down on the rear edge of the emberbed until it snaps into place (FIGURE 8).

NOTE

Ensure the logset is installed tightly under the back ledge to prevent light leakage.

12. Close the bi-fold doors.

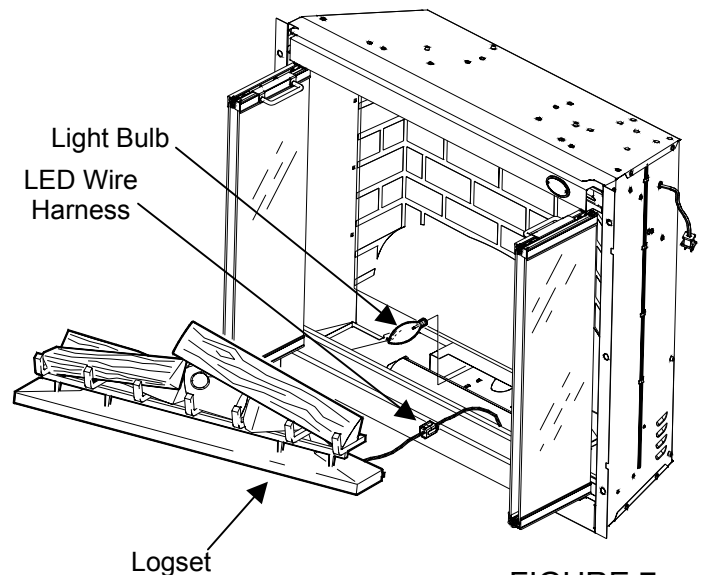

FIGURE 7

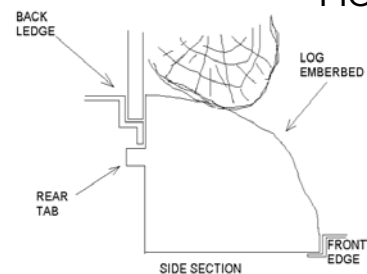

FIGURE 8

UPPER LIGHT BULB REQUIREMENTS

Quantity of 2 clear chandelier or candelabra bulbs with an E-12 (small) socket base, 25 watt rating.

DO NOT EXCEED 25 WATTS PER BULB

To access the upper light bulb area:

1. Open the bi-fold doors.
2. Remove upper light bracket with a screwdriver.
3. Replace bulb.
4. Reassemble in the reverse order as above.

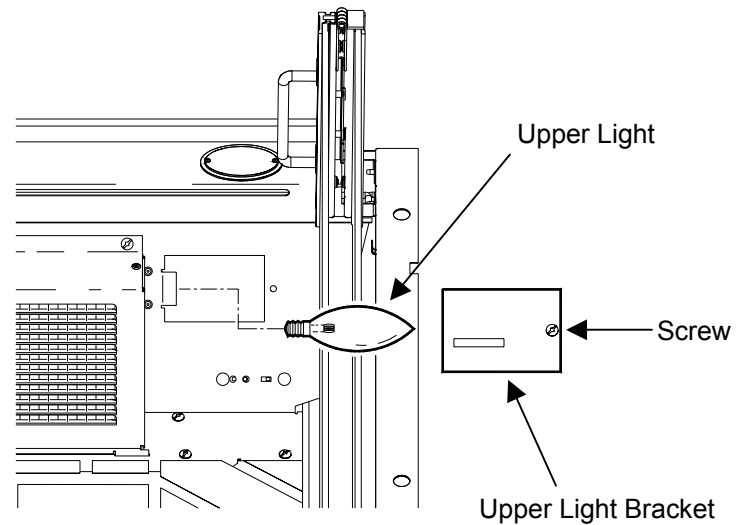

FIGURE 9

PURIFIRE™ FILTER

The Purifire™ filter supplied in your fireplace is reusable and washable. The filter should be cleaned or replaced on average once a year. To clean the filter gently tap filter on a hard surface to dislodge any loose dirt or debris, and then clean with water. No soap or cleaning products are recommended. The filter size is 20" X 10" X 1" rated at MERV 10. If using an after market filter follow the manufacturers recommended replacement instructions.

To replace filter:

1. Open the bi-fold doors.
2. Remove the 3 mounting screws from the air filter bracket.
3. Remove the air filter bracket assembly from the firebox.
4. Slide filter out of air filter bracket.
5. Reassemble in reverse order as above.

NOTE

If after market air filter is used ensure it is installed according to the manufacturers recommended instructions.

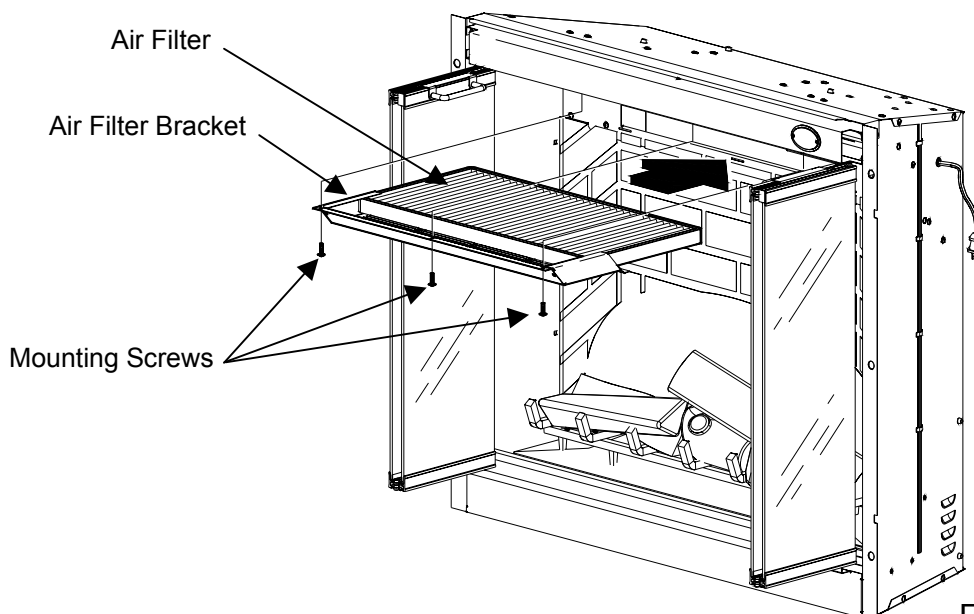

FIGURE 10

GLASS CLEANING

The glass is cleaned in the factory during the assembly operation. During shipment, installation, handling, etc., the glass may collect dust particles, these can be removed by dusting lightly with a clean dry cloth.

To remove fingerprints or other marks, the glass can be cleaned with a damp cloth. To prevent scratching, do not use abrasive cleaners or spray liquids on the glass surface.

FIREPLACE SURFACE CLEANING

Use a cloth dampened with warm water only to clean painted surfaces of the electric fireplace. Do not use abrasive cleaners.

TEN YEAR LIMITED WARRANTY

Products to which this limited warranty applies

This limited warranty applies to the following model of your newly purchased Dimplex electric fireplace **DF3215** and to newly purchased Dimplex fireplace surrounds (mantels) and trims. This limited warranty applies only to purchases made in any province of Canada *except* for Yukon Territory, Nunavut, or Northwest Territories or in any of the 50 States of the USA (and the District of Columbia) *except* for Hawaii and Alaska. This limited warranty applies to the original purchaser of the product only and is not transferable.

Products excluded from this limited warranty

Light bulbs and Purifire™ filters are not covered by this limited warranty and are the sole responsibility of the owner/purchaser. Products purchased in Yukon Territory, Nunavut, Northwest Territories, Hawaii, or Alaska are not covered by this limited warranty. Products purchased in these States, provinces, or territories are sold AS IS without warranty or condition of any kind (including, without limitation, any implied warranties or conditions of merchantability or fitness for a particular purpose) and the entire risk of as to the quality and performance of the products is with the purchaser, and in the event of a defect the purchaser assumes the entire cost of all necessary servicing or repair.

What this limited warranty covers and for how long

Products, other than fireplace surrounds (mantels) and trims, covered by this limited warranty have been tested and inspected prior to shipment. Subject to the provisions of this warranty, Dimplex warrants such products to be free from defects in material and workmanship for a period of 10 years from the date of the first purchase of such products as follows: (a) a repair or replacement warranty on defective products or parts, including in-home services, for the first three years following the date of first purchase; and (b) thereafter, a replacement of parts warranty on defective products and parts (with no in-home services) for the 7 year period commencing on the second anniversary of first purchase and ending on the tenth anniversary of the date of first purchase.

Dimplex fireplace surrounds (mantels) and trims covered by this limited warranty have been tested and inspected prior to shipment and, subject to the provisions of this warranty, Dimplex warrants such products to be free from defects in material and workmanship for a period of 1 year from the date of first purchase of such products. Warranty services do not include in-home services.

The above section is a summary only of your warranty rights. Please review the remaining provisions of this warranty for your specific rights.

The limited 10 year warranty period for products other than fireplace surrounds (mantels) and trims and the limited 1 year warranty period for fireplace surrounds (mantels) and trims also applies to any implied warranties that may exist under applicable law. Some jurisdictions do not allow limitations on how long an implied warranty lasts, so the above limitation may not apply to the purchaser.

What this limited warranty does not cover

This limited warranty does not apply to products that have been repaired (except by Dimplex or its authorized service representatives) or otherwise altered. This limited warranty does further not apply to defects resulting from misuse, abuse, accident, neglect, incorrect installation, improper maintenance or handling, or operation with an incorrect power source.

What you must do to get service under this limited warranty

Defects must be brought to the attention of Dimplex Technical Service by contacting Dimplex at 1-888-[DIMPLEX](tel:1-888-DIMPLEX) (1-888-346-7539), or 1367 Industrial Road, Cambridge Ontario, Canada N1R 7G8. Please have proof of purchase, catalogue/model and serial numbers available when calling. Limited warranty service requires a proof of purchase of the product.

What Dimplex will do in the event of a defect

In the event a product or part covered by this limited warranty is proven to be defective in material or workmanship during (i) the 10 year limited warranty period for products other than fireplace surrounds (mantels) and trims, and (ii) the 1 year limited warranty period for surrounds (mantels) and trims, you have the following rights:

- Limited warranty service will be performed solely by dealers or service agents of Dimplex authorized to provide limited warranty services.
- **For products (other than surrounds (mantels) and trims) for the period ending at midnight on the third anniversary of the date of first purchase**, Dimplex will in its sole discretion either repair or replace such defective product or part without charge. If Dimplex is unable to repair or replace such product or part, or if repair or replacement is not commercially practicable or cannot be timely made, Dimplex may, in lieu of repair or replacement, choose to refund the purchase price for such product or part. *This limited warranty entitles the purchaser to on-site or in-home warranty services.* Accordingly, Dimplex will be responsible for all labour and transportation costs associated with the repair or replacement of the product or part except as follows: (i) charges may be levied for travel costs incurred to travel to the purchaser's site where the product is located if the purchaser's site is beyond 30 miles (48 km) from the closest service depot of Dimplex's dealer or service agent; and (ii) the purchaser is solely responsible for providing clear access to all serviceable parts of the product.
- **For products (other than surrounds (mantels) and trims) for the period commencing at 12:01 a.m. on the day after the third anniversary of the first purchase and ending at midnight on the tenth anniversary of the date of first purchase**, this limited warranty entitles the purchaser to replacement parts only without charge. If Dimplex is unable to replace such part, or if replacement is not commercially practicable or cannot be timely made, Dimplex may, in lieu of replacement, choose to refund the purchase price for such part. The purchaser shall not be entitled to on-site or in-home warranty services. The purchaser shall be responsible for all expenses incurred for the removal of the part and installation of the replacement part including, without limitation, all shipping costs and transportation costs to and from the authorized dealer's or service agent's place of business and all labour costs. Such costs shall not be the responsibility of Dimplex.

- **For surrounds (mantels) and trims for the period ending at midnight on the first anniversary of the date of first purchase**, Dimplex will in its sole discretion either repair or replace such defective surrounds (mantels) and trims or part thereof without charge. If Dimplex is unable to repair or replace such product or part, or if repair or replacement is not commercially practicable or cannot be timely made, Dimplex may, in lieu of repair or replacement, choose to refund the purchase price for such product or part. The purchaser shall not be entitled to on-site or in-house services. The purchaser is responsible for all expenses incurred for repair or replacement of such product or part including, without limitation, all shipping costs and transportation costs to and from the authorized dealer's or service agent's business and all labour costs. Such costs shall not be the responsibility of Dimplex.
- On-site or in-home services not provided under this warranty may be performed at the purchaser's specific request and expense at Dimplex's then-current rates for such services.

What Dimplex and its dealers and service agents are also not responsible for:

IN NO EVENT WILL DIMPLEX, OR ITS DIRECTORS, OFFICERS, OR AGENTS, BE LIABLE TO THE PURCHASER OR ANY THIRD PARTY, WHETHER IN CONTRACT, IN TORT, OR ON ANY OTHER BASIS, FOR ANY INDIRECT, SPECIAL, PUNITIVE, EXEMPLARY, CONSEQUENTIAL, OR INCIDENTAL LOSS, COST, OR DAMAGE ARISING OUT OF OR IN CONNECTION WITH THE SALE, MAINTENANCE, USE, OR INABILITY TO USE THE PRODUCT, EVEN IF DIMPLEX OR ITS DIRECTORS, OFFICERS, OR AGENTS HAVE BEEN ADVISED OF THE POSSIBILITY OF SUCH LOSSES, COSTS OR DAMAGES, OR IF SUCH LOSSES, COSTS, OR DAMAGES ARE FORESEEABLE. IN NO EVENT WILL DIMPLEX, OR ITS OFFICERS, DIRECTORS, OR AGENTS BE LIABLE FOR ANY DIRECT LOSSES, COSTS, OR DAMAGES THAT EXCEED THE PURCHASE PRICE OF THE PRODUCT.

SOME JURISDICTIONS DO NOT ALLOW THE EXCLUSION OR LIMITATION OF INCIDENTAL OR CONSEQUENTIAL DAMAGES, SO THE ABOVE LIMITATION OR EXCLUSION MAY NOT APPLY TO THE PURCHASER.

How State and Provincial law apply

This limited warranty gives you specific legal rights, and you may also have other rights which vary from jurisdiction to jurisdiction. The provisions of the United Nations Convention on Contracts for the Sale of Goods shall not apply to this limited warranty or the sale of products covered by this limited warranty.

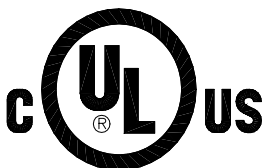

1-888-DIMPLEX
1-888-346-7539

Dimplex®

1367 Industrial Road
Cambridge, Ontario
Canada, N1R 7G8

Approved for use in the United States and Canada