

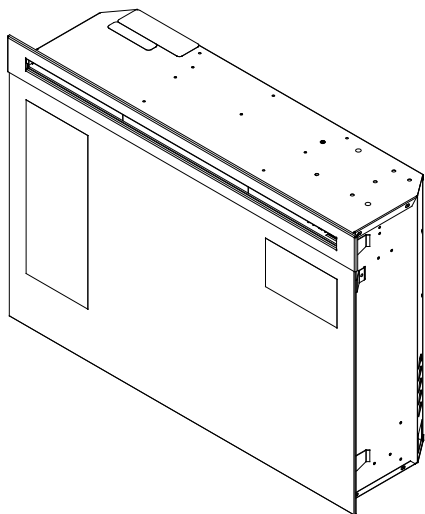

Better solutions through innovation



Owner's Manual

Model
DF3033ST









IMPORTANT SAFETY INFORMATION: Always read this manual first before attempting to install or use this fireplace. For your safety, always comply with all warnings and safety instructions contained in this manual to prevent personal injury or property damage.

To view the full line of Dimplex products, please visit
www.dimplex.com

7209120100R05



Table of Contents

 Welcome & Congratulations	3
 IMPORTANT INSTRUCTIONS	4
 Quick Reference Guide	7
 Site Selection and Preparation	7
 Fireplace Installation	8
 Operation	11
 Maintenance.	16
 Warranty	18
 Replacement Parts List	22

Always use a qualified technician or service agency to repair this fireplace.

! NOTE: Procedures and techniques that are considered important enough to emphasize.

⚠ CAUTION: Procedures and techniques which, if not carefully followed, will result in damage to the equipment.

⚠ WARNING: Procedures and techniques which, if not carefully followed, will expose the user to the risk of fire, serious injury, or death.

Welcome & Congratulations

Thank you and congratulations for choosing to purchase an electric fireplace from Dimplex, the world leader in electric fireplaces.

Please carefully read and save these instructions.

⚠ CAUTION: Read all instructions and warnings carefully before starting installation. Failure to follow these instructions may result in a possible electric shock, fire hazard and will void the warranty.

Please record your model and serial numbers below for future reference: model and serial numbers can be found on the Model and Serial Number Label of your fireplace.

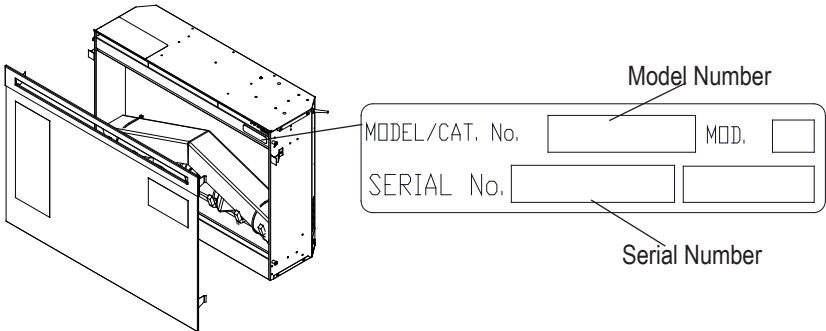

STOP NO NEED TO RETURN TO THE STORE

Questions with operation or assembly? Require Parts Information?
Product Under Manufacturer's Warranty?

Contact us at:  www.dimplex.com/customer_support
For Troubleshooting and Technical Support

OR  **Toll-Free 1-888-DIMPLEX (1-888-346-7539)**
Monday to Friday 8:00 a.m. to 4:30 p.m. EST
Please have your model number and product serial number ready. (See above)

IMPORTANT INSTRUCTIONS

When using electrical appliances, basic precautions should always be followed to reduce the risk of fire, electric shock, and injury to persons, including the following:

- ① Read all instructions before using the electric fireplace.
- ② The heater is hot when in use. To avoid burns, do not let bare skin touch hot surfaces. The trim around the heater outlet becomes hot during heater operation. Keep combustible materials, such as furniture, pillows, bedding, papers, clothes, and curtains at least three (3) feet (0.9 m) from the front of the unit.
- ③ Extreme caution is necessary when any heater is used by or near children or invalids and whenever the unit is left operating and unattended.
- ④ Always unplug the electric fireplace when not in use.
- ⑤ Do not operate any unit with a damaged cord or plug, or if the heater has malfunctioned, or if the electric fireplace has been dropped or damaged in any manner. Return heater to authorized service facility for examination, electrical or mechanical adjustment, or repair.
- ⑥ Do not use outdoors.
- ⑦ The electric fireplace is not intended for use in bathrooms, laundry areas and similar indoor locations. Never locate heater where it may fall into a bathtub or other water container.
- ⑧ Do not run the cord under carpeting. Do not cover cord with throw rugs, runners, or the like. Arrange cord away from traffic area and where it will not be tripped over.
- ⑨ To disconnect the unit, turn the controls off, then remove the plug from the outlet.
- ⑩ Do not insert or allow foreign objects to enter any ventilation or exhaust opening as this may cause an electric shock or fire, or damage to the heater.
- ⑪ To prevent a possible fire, do not block air intake or exhaust in any manner. Do not use on soft surfaces, like a bed, where openings may become blocked.
- ⑫ All electrical heaters have

IMPORTANT INSTRUCTIONS

hot and arcing or sparking parts inside. Do not use in areas where gasoline, paint, or flammable liquids are used or stored or where the unit will be exposed to flammable vapors.

⑬ Do not modify the electric fireplace. Use it only as described in this manual. Any other use not recommended by the manufacturer may cause fire, electric shock or injury to persons.

⑭ Avoid the use of an extension cord or power bar. Extension cords and power bars may overheat and cause a risk of fire. If you must use an extension cord or power bar, it must be No. 14 AWG minimum size and rated for no less than 1875 Watts.

⑮ Do not burn wood or other materials in the electric fireplace.

⑯ Do not strike the fireplace glass.

⑰ Always use a certified electrician should new circuits or outlets be required.

⑱ Always use properly grounded, fused and polarized outlets.

⑲ Disconnect all power supply before performing any cleaning, maintenance or relocation of the unit.

⑳ When transporting or storing the unit and cord, keep in a dry place, free from excessive vibration and store so as to avoid damage.



CAUTION
RISK OF ELECTRIC SHOCK
DO NOT OPEN
NO USER-SERVICABLE PARTS INSIDE



SAVE THESE INSTRUCTIONS

IMPORTANT INSTRUCTIONS

⚠ CAUTION: This equipment has been tested and found to comply with the limits for a Class B digital device, pursuant to Part 15 of the FCC Rules. These limits are designed to provide reasonable protection against harmful interference in a residential installation. This equipment generates uses and can radiate radio frequency energy and, if not installed and used in accordance with the instructions, may cause harmful interference to radio communications. However, there is no guarantee that interference will not occur in a particular installation. If this equipment does cause harmful interference to radio or television reception, which can be determined by turning the equipment off and on, the user is encouraged to try to correct the interference by one of the following measures:

- Reorient or relocate the receiving antenna.
- Increase the separation between the equipment and receiver.
- Connect the equipment into an outlet on a circuit different from that to which the receiver is connected.
- Consult the dealer or an experienced radio/TV technician for help.

This device complies with Part 15 of the FCC Rules. Operation is subject to the following two conditions: (1) This device may not cause harmful interference, and (2) this device must accept any interference received, including interference that may cause undesired operation.

⚠ FCC CAUTION: Any changes or modifications not expressly approved by the party responsible for compliance could void the user's authority to operate this equipment.

This device complies with Industry Canada licence-exempt RSS standard(s). Operation is subject to the following two conditions: (1) this device may not cause interference, and (2) this device must accept any interference, including interference that may cause undesired operation of the device.

Under Industry Canada regulations, this radio transmitter may only operate using an antenna of a type and maximum (or lesser) gain approved for the transmitter by Industry Canada. To reduce potential radio interference to other users, the antenna type and its gain should be so chosen that the equivalent isotropically radiated power (e.i.r.p.) is not more than that necessary for successful communication.

⚠ WARNING: Remote control contains small batteries. Keep away from children. If swallowed, seek medical attention immediately.

⚠ WARNING: Do not install battery backwards, charge, put in fire or mix with used or other battery types - may explode or leak causing injury.

! NOTE: Changes or modifications not expressly approved by the party responsible for compliance could void user's authority to operate the equipment.



Quick Reference Guide

① Prior to the first use of the fireplace verify the following:

- Are the circuit breakers for the unit on?
- Are the light bulbs in your fireplace loose? (To check, follow the instructions for replacing the light bulbs under the Maintenance section of this manual.)

② The heater on your fireplace may emit a slight, harmless odor when first used. This odor is a normal condition caused by the initial heating of internal heater parts and will not occur again.

③ The information regarding the model of your fireplace can be found on the rating plate located on the front of the unit.



Site Selection and Preparation

! NOTE 1: A 15 Amp, 120 Volt circuit is required. A dedicated circuit is preferred but not essential in all cases. A dedicated circuit will be required if, after installation, the circuit breaker trips or fuse blows on a regular basis when the heater is operating. Additional appliances on the same circuit may exceed the current rating of the circuit breaker.

⚠ WARNING: Ensure the power cord is not installed so that it is pinched or against a sharp edge and ensure that the power cord is stored or secured to avoid tripping or snagging to reduce the risk of fire, electric shock or injury to persons.

Construction and electrical outlet wiring must comply with local building codes and other applicable regulations to reduce the risk of fire, electric shock and injury to persons.

Do not attempt to wire your own new outlets or circuits. To reduce the risk of fire, electric shock or injury to persons, always use a licensed electrician.

This section provides instructions for selecting a location and preparing the site to install the fireplace into your Dimplex mantel surround.

1. Select a suitable location that is not susceptible to moisture and is away from drapes,

Site Selection and Preparation

furniture and high traffic.

2. For ease of electrical hook up you may wish to locate the fireplace near an existing outlet (refer to NOTE 1).
3. Store the fireplace in a safe dry and dust free location.

! NOTE: The dimensions of the fireplace are 31 ½ inches

(800 mm) wide x 22 ¾ inches (568 mm) high x 9 ½ inches (232 mm) deep. The fireplace does not require any additional venting.

Fireplace Installation

! CAUTION: Clearance for air circulation beneath the fireplace insert is provided by two (2) rubber feet.

Do not install the fireplace insert directly on carpet or similar surfaces which may restrict air circulation.

! CAUTION: If installing the fireplace in a carpeted area, place a one-piece, solid, flat surface under the fireplace insert. Ensure that both of the insert's feet rest securely on this surface.

Mantel Installation

Install the fireplace assembly into the mantel (refer to mantel assembly instructions).

! IMPORTANT: If not using

Figure 1

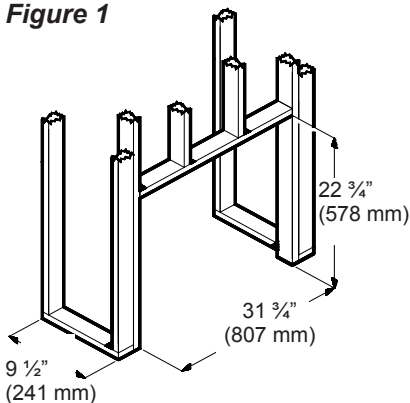

a Dimplex mantel, the fireplace must be installed in an enclosure with the following **minimum** internal/opening dimensions (Figure 1).

New Wall Construction

1. Select a suitable location that

Fireplace Installation

is not susceptible to moisture and is away from drapes, furniture and high traffic.

2. Place the fireplace in the desired location to see how it will look in the room.
3. Mark the desired location on the floor and store the fireplace in a safe, dry and dust free location.
4. Use studs to frame an opening of 31 ¾ inches (807 mm) wide x 22 ¾ inches (578 mm) high x 9 ½ inches (241 mm) deep.

Option #1 - The power cord can be lead from behind the trim and along the wall to an outlet near the fireplace.

Option #2 - A new outlet can be installed inside the new frame construction. Plug the unit into a 15 Amp, 120 Volt outlet. If the cord does not reach, you may use an extension cord rated for a minimum of 1875 Watts.

Option #3 - Hardwire

1. Wire a dedicated, properly fused circuit with 120 Volt, 15 Amp rating. Allow up to eight (8) feet (2.4 m) of service cable for connecting power supply to junction box on

fireplace when installing after finishing wall.

CAUTION: Use two conductor, non-metallic sheath cable with ground wire (three (3) wires total) for the incoming power supply on fireplace inserts. Use appropriate wire to meet local and national electrical codes for rated power consumption.

2. Remove the outer jacket and strip the individual conductor from the end.
3. Loosen the screw securing the junction box cover and remove the cover.
4. Take the cables out from the junction box, loosen the two wire twist nuts and remove the power cord (Figure 2).
5. Route the power supply wire through the knockout on supplied alternative junction

Figure 2

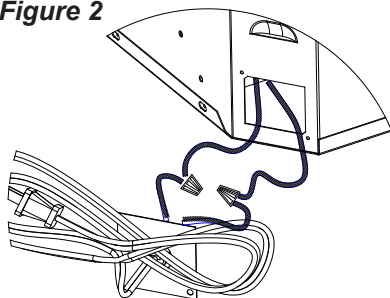

Fireplace Installation

box cover and secure with a wire clamp (not supplied) (Figure 3).

6. Connect the black wire (live) from the unit to the black wire from power supply (Figure 3).
7. Connect the white wire (neutral) from the unit to the white wire from power supply (Figure 3).
8. Connect the green wire (ground) from the unit to the green wire from power supply (Figure 3).
9. Place all connectors inside the unit and secure the junction box cover to unit. Ensure that the cable clamp grips only the jacket of service cable.

Figure 3

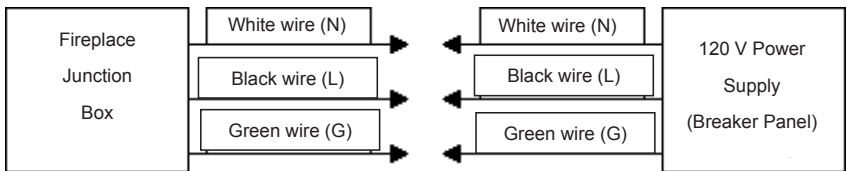
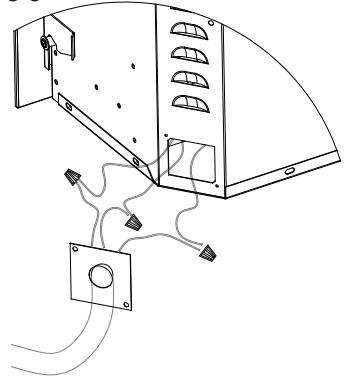

Operation

Electric Fireplace Manual Control

The manual controls for the fireplace are located in the upper right hand corner (Figure 4).

Figure 4

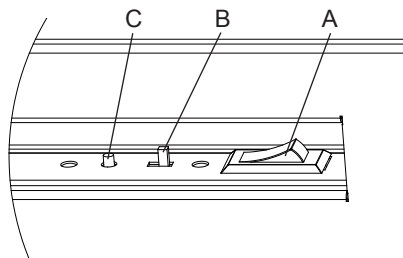

A. On/Off Switch

Supplies power to the 3-Position Switch.

B. 3-Position Switch

Remote (left position): The unit is operated with the remote control.

Flame (center position): The flame effect is turned on.

Flame & Heat (right position): The flame effect and heater are turned on simultaneously. When the manual control is in the **Flame & Heat** position the heater does not run on the remote operated thermostat.

! NOTE: When the 3-position

switch is in the **Flame** or **Flame & Heat** positions, the fireplace unit will not operate with the remote control.

C. Initialization Button

Used to synchronize the remote control with the fireplace.

Resetting the Temperature Cutoff Switch

Should the heater overheat, an automatic switch will turn the heater off and it will not come back on without being reset. The temperature cutoff switch can be reset by unplugging the unit, waiting five (5) minutes and plugging the unit back in.

⚠ CAUTION: If you need to continuously reset the heater, unplug the unit and call Dimplex North America Limited at 1-888-346-7539 for technical support. Please have your model and serial number ready when calling.

Remote Control

The remote control has a range of approximately 50 feet (15.25 m), it does not have to be pointed at the fireplace and can pass through most obstacles (including walls). It is supplied with 243

Operation

independent frequencies to prevent interference with other units.

Battery Installation

1. Depress tab on the battery cover on the back of the remote control and remove battery cover (Figure 5).
2. Install two (2) AAA batteries into the remote control (included).
3. Ensure child lock is in the “unlocked” position (Figure 5).
4. Replace the battery cover.

! NOTE: When the “BAT” symbol is present on the remote control it is recommended to replace the batteries promptly, to maintain full functionality of the remote/fireplace. The remote control has a battery backup time of only several hours.



Battery must be recycled or disposed of properly. Check with your Local Authority or Retailer for recycling advice in your area.

Figure 5

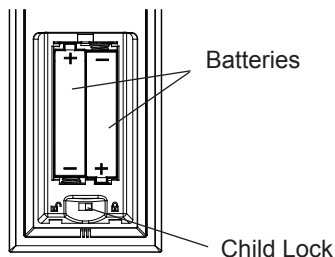

Initializing/Reprogramming the Remote Control

1. Plug cord into 120 Volt wall outlet.
2. Ensure the On/Off Switch located in the switch box on the fireplace in the upper right hand corner is in the **— ON** position (Figure 4A).
3. Set the 3 Position Manual Control (Figure 4B) to the **Remote** position (left position).
4. Press and hold the Initialization Button on the unit (Figure 4C).
5. While holding the Initialization Button, press the Flame/Heat On/Off  button on the remote control.
6. Release the Initialization Button on the unit.

Operation

7. Press the Flame/Heat On/Off button  to turn the Flame/Heat function on.

Frequency Interference

If the fireplace does not respond properly to the remote control, the remote operating frequency may have to be reset. The remote control can send another frequency code to the remote control receiver to eliminate interference.

- ① Simultaneously press the “**Temperature Down**” button and the “**Flame Speed Down**” button on the remote control (Figure 6).
- ② “**COD**” will appear in place of the sleep timer digits.
- ③ Release the “**Temperature Down**” button and the “**Flame Speed Down**” button.
- ④ Press the Initialization Button on the unit (Figure 4C).
- ⑤ Press the Flame/Heat On/Off Button  button on the remote. Your remote will now have a different frequency communicating with the fireplace.

Remote Control Functions

(All letter references are to Figure 6)

B. Set Temperature

Press **F** button  to turn fireplace on.

Press **H** to raise thermostat.

Press **G** to lower thermostat.

Press both **H** and **G** to change °F to °C.

C. Dimmer

Press the **F** button  to turn the Flame/Heat on.

Repeatedly press the **J** or **I** button to decrease or increase the brightness of the upper lights.

D. Flame Speed

Press the **F** button  to turn the Flame/Heat on.

Press the **L** button to increase the speed of the flame.

Press the **K** to decrease the speed of the flame.

E. Sleep Timer

The Sleep Timer automatically shuts off the fireplace after a preset time (from 30 minutes to 8 hours).

Press the **F** button  to turn the fireplace on.

🔑 Operation

Figure 6 - Remote Control Functions

- A. Room Temperature
- B. Set Temperature
- C. Dimmer
- D. Flame Speed Control
- E. Sleep Timer
- F. Flame & Heat On/Off
- G. Temperature Down
- H. Temperature Up
- I. Dimmer Down
- J. Dimmer Up
- K. Flame Speed Down
- L. Flame Speed Up
- M. Sleep Timer Down
- N. Sleep Timer Up

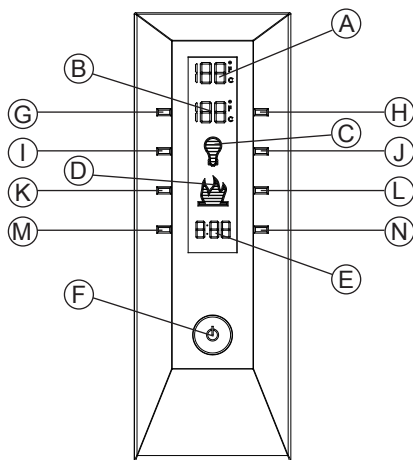

To set the sleep timer press the **N** button.

Set the timer from 30 minutes through 8 hours. The fireplace will automatically turn off when the sleep timer reaches zero (0) minutes.

The Sleep Timer can be cancelled at any time by pressing the **M** button repeatedly until the sleep timer displays nothing.

⚠️ WARNING: Disconnect power before attempting any maintenance or cleaning to reduce the risk of fire, electric shock or damage to persons.

F. Flame & Heat On/Off Button

Press the **F** button  to turn the Flame/Heat function on. When **B** is higher than **A** the heat will come on. To turn the heat off, lower the **B** so that it's setting is lower than the **A**. The default temperature setting is 72°F (22°C).

! NOTE: When using the remote control the heater runs on a thermostat. Press the **H** or **G** buttons to adjust the set temperature. Once the desired set temperature is reached the heater will turn off. The heater will cycle on and

Operation

off to maintain the desired set temperature.

Child Lock (Figure 7)

1. Depress tab on the battery cover on the back of the remote control and remove the battery cover (Figure 5).
2. Move **Child Lock** tab to the right to lock the remote control.
3. Move **Child Lock** tab back to the left to unlock the remote control.
4. Replace the battery cover.

! NOTE: To temporarily unlock

the remote control press (in order) **G** then **H** then **I**.

When the remote control's backlight is illuminated the **Child Lock** is bypassed. When the backlight is off the **Child Lock** is re-activated.

Figure 7

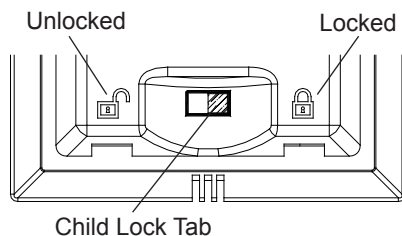



Maintenance

Light Bulb Replacement

Allow at least five (5) minutes for light bulbs to cool before touching bulbs to avoid accidental burning of skin.

Light bulbs need to be replaced when you notice a dark section of the flame or when the clarity and detail of the log ember bed exterior disappears. There are three (3) bulbs under the log set, which generate the flames and embers, and two (2) bulbs above the log that illuminate the log exterior.

Lower Light Bulb Requirements

Quantity of three (3) clear chandelier or candelabra bulbs with an E-12 (small) socket base, 60 Watt rating. Example: GE 60BC or Philips 60 CTC.

Do not exceed 60 Watts per bulb.

Helpful Hints: It is a good idea to replace all light bulbs at one time if they are close to the end of their rated life. Group replacement will reduce the number of times you need to open the unit to replace light bulbs. Care must be taken when removing the log set as the log set contains LED's and wires.

Figure 8

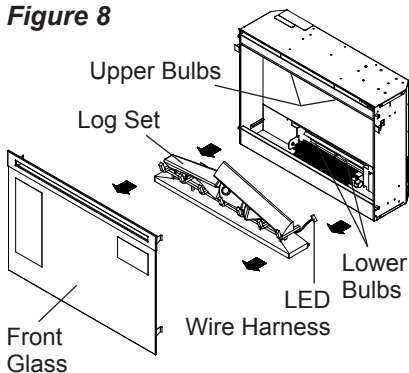

To access the lower light bulb area:

1. Remove front glass assembly.
2. Pull the front edge of the plastic ember bed or plastic grate up and forward until the rear tab releases from the ledge located at the bottom of the Partially Reflective Glass (Figure 10).

! IMPORTANT: Only handle the log set by the ember bed.

! NOTE: Log set fits tightly into firebox, some force may be necessary to remove.

3. Set log set in front of fireplace.
4. Disconnect the log set LED wire harness from unit.
5. Gently pull the flicker rod to the right as far as possible



Maintenance

Figure 9

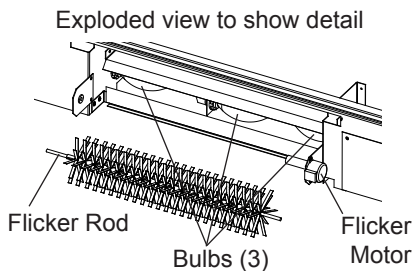

into the rubber bushing on the flicker motor shaft (Figure 9).

6. Unscrew bulbs counter clockwise.
7. Insert new bulbs.
8. Reconnect the log set LED wire harness.
9. Install the log set by placing the front, bottom edge of the ember bed in the track behind the front panel. Once in place, push down on the back edge of the ember bed until the rear tab snaps into place under the Partially Reflective Glass (Figure 10).

! NOTE: Ensure the log set is installed tightly under the back ledge to prevent light leakage.

10. Replace glass assembly.

Upper Light Bulb Requirements

Quantity of two (2) clear chandelier or candelabra bulbs

Figure 10

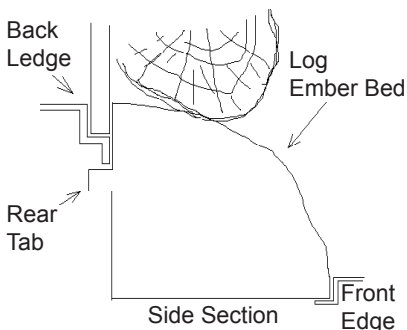

with an E-12 (small) socket base, 15 Watt rating.

Do not exceed 15 Watts per bulb.

To access the upper light bulb area:

1. Remove front glass assembly.
2. Upper bulbs are located in the upper left and upper right corners of fireplace (Figure 8).
3. Remove the upper light cover for each bulb (two (2) Philips screws each).
4. Unscrew bulbs counter clockwise.
5. Insert new bulbs.
6. Re-install upper light bracket.
7. Replace glass assembly.



Maintenance

Glass Cleaning

The glass is cleaned in the factory during the assembly operation.

During shipment, installation, handling, etc., the glass may collect dust particles; these can be removed by dusting lightly with a clean dry cloth.

To remove fingerprints or other marks, the glass can be cleaned with a damp cloth. To prevent

scratching, do not use abrasive cleaners or spray liquids on the glass surface.

Fireplace Surface Cleaning

Use a cloth dampened with warm water only to clean painted surfaces of the electric fireplace. Do not use abrasive cleaners.



Warranty

Products to which this limited warranty applies

This limited warranty applies to the following model of your newly purchased Dimplex electric fireplace **DF3033ST** and to newly purchased Dimplex fireplace surrounds (mantels) and trims. This limited warranty applies only to purchases made in any province of Canada except for Yukon Territory, Nunavut, or Northwest Territories or in any of the 50 States of the USA (and the District of Columbia) except for Hawaii and Alaska. This limited warranty applies to the original purchaser of the product only and is not transferable.

Products excluded from this limited warranty

Light bulbs are not covered by this limited warranty and are the sole responsibility of the owner/purchaser. Products purchased in Yukon Territory, Nunavut, Northwest Territories, Hawaii, or Alaska are not covered by this limited warranty. Products

purchased in these States, provinces, or territories are sold AS IS without warranty or condition of any kind (including, without limitation, any implied warranties or conditions of merchantability or fitness for a particular purpose) and the entire risk of as to the quality and performance of the products is with the purchaser, and in the event of a defect the purchaser assumes the entire cost of all necessary servicing or repair.

What this limited warranty covers and for how long

Products, other than fireplace surrounds (mantels) and trims, covered by this limited warranty have been tested and inspected prior to shipment. Subject to the provisions of this warranty, Dimplex warrants such products to be free from defects in material and workmanship for a period of 5 years from the date of the first purchase of such products as follows: (a) a repair or replacement warranty on defective products or parts, including



Warranty

in-home services, for the first 1 year following the date of first purchase; and (b) thereafter, a replacement of parts warranty on defective products and parts (with no in-home services) for the 4 year period commencing on the second anniversary of first purchase and ending on the fifth anniversary of the date of first purchase.

Dimplex fireplace surrounds (mantels) and trims covered by this limited warranty have been tested and inspected prior to shipment and, subject to the provisions of this warranty, Dimplex warrants such products to be free from defects in material and workmanship for a period of 1 year from the date of first purchase of such products. Warranty services do not include in-home services.

The above section is a summary only of your warranty rights. Please review the remaining provisions of this warranty for your specific rights.

The limited 5 year warranty period for products other than fireplace surrounds (mantels) and trims and the limited 1 year warranty period for fireplace surrounds (mantels) and trims also applies to any implied warranties that may exist under applicable law. Some jurisdictions do not allow limitations on how long an implied warranty lasts, so the above limitation may not apply to the purchaser.

What this limited warranty does not cover

This limited warranty does not apply to products that have been repaired (except by Dimplex or its authorized service representatives) or otherwise altered. This limited warranty does further not apply to defects resulting from misuse, abuse, accident, neglect, incorrect installation, improper maintenance or handling, or

operation with an incorrect power source.

What you must do to get service under this limited warranty

Defects must be brought to the attention of Dimplex Technical Service by contacting Dimplex at 1-888-[DIMPLEX](tel:1-888-DIMPLEX) (1-888-346-7539), or 1367 Industrial Road, Cambridge Ontario, Canada N1R 7G8. Please have proof of purchase, catalogue/model and serial numbers available when calling. Limited warranty service requires a proof of purchase of the product.

What Dimplex will do in the event of a defect:

In the event a product or part covered by this limited warranty is proven to be defective in material or workmanship during (i) the 5 year limited warranty period for products other than fireplace surrounds (mantels) and trims, and (ii) the 1 year limited warranty period for surrounds (mantels) and trims, you have the following rights:

- Limited warranty service will be performed solely by dealers or service agents of Dimplex authorized to provide limited warranty services.
- **For products (other than surrounds (mantels) and trims) for the period ending at midnight on the first anniversary of the date of first purchase**, Dimplex will in its sole discretion either repair or replace such defective product or part without charge. If Dimplex is unable to repair or replace such product or part, or if repair or replacement is not commercially practicable or cannot be timely made, Dimplex may, in lieu of repair or replacement, choose to refund the purchase price for such



Warranty

product or part. This limited warranty entitles the purchaser to on-site or in-home warranty services. Accordingly, Dimplex will be responsible for all labour and transportation costs associated with the repair or replacement of the product or part except as follows: (i) charges may be levied for travel costs incurred to travel to the purchaser's site where the product is located if the purchaser's site is beyond 30 miles (48 km) from the closest service depot of Dimplex's dealer or service agent; and (ii) the purchaser is solely responsible for providing clear access to all serviceable parts of the product.

- **For products (other than surrounds (mantels) and trims) for the period commencing at 12:01 a.m. on the day after the first anniversary of the first purchase and ending at midnight on the fifth anniversary of the date of first purchase**, this limited warranty entitles the purchaser to replacement parts only without charge. If Dimplex is unable to replace such part, or if replacement is not commercially practicable or cannot be timely made, Dimplex may, in lieu of replacement, choose to refund the purchase price for such part. The purchaser shall not be entitled to on-site or in-home warranty services. The purchaser shall be responsible for all expenses incurred for the removal of the part and installation of the replacement part including, without limitation, all shipping costs and transportation costs to and from the authorized dealer's or service agent's place of business and all labour costs. Such costs shall not be the

responsibility of Dimplex.

- **For surrounds (mantels) and trims for the period ending at midnight on the first anniversary of the date of first purchase**, Dimplex will in its sole discretion either repair or replace such defective surrounds (mantels) and trims or part thereof without charge. If Dimplex is unable to repair or replace such product or part, or if repair or replacement is not commercially practicable or cannot be timely made, Dimplex may, in lieu of repair or replacement, choose to refund the purchase price for such product or part. The purchaser shall not be entitled to on-site or in-house services. The purchaser is responsible for all expenses incurred for repair or replacement of such product or part including, without limitation, all shipping costs and transportation costs to and from the authorized dealer's or service agent's business and all labour costs. Such costs shall not be the responsibility of Dimplex.
- On-site or in-home services not provided under this warranty may be performed at the purchaser's specific request and expense at Dimplex's then-current rates for such services.

What Dimplex and its dealers and service agents are also not responsible for:

IN NO EVENT WILL DIMPLEX, OR ITS DIRECTORS, OFFICERS, OR AGENTS, BE LIABLE [TO THE PURCHASER OR ANY THIRD PARTY](#), WHETHER IN CONTRACT, IN TORT, OR ON ANY OTHER BASIS, FOR ANY INDIRECT, SPECIAL, PUNITIVE, EXEMPLARY, CONSEQUENTIAL, OR INCIDENTAL



Warranty

LOSS, COST, OR DAMAGE ARISING OUT OF OR IN CONNECTION WITH THE SALE, MAINTENANCE, USE, OR INABILITY TO USE THE PRODUCT, EVEN IF DIMPLEX OR ITS DIRECTORS, OFFICERS, OR AGENTS HAVE BEEN ADVISED OF THE POSSIBILITY OF SUCH LOSSES, COSTS OR DAMAGES, OR IF SUCH LOSSES, COSTS, OR DAMAGES ARE FORESEEABLE. IN NO EVENT WILL DIMPLEX, OR ITS OFFICERS, DIRECTORS, OR AGENTS BE LIABLE FOR ANY DIRECT LOSSES, COSTS, OR DAMAGES THAT EXCEED THE PURCHASE PRICE OF THE PRODUCT.

SOME JURISDICTIONS DO NOT ALLOW THE EXCLUSION OR LIMITATION OF INCIDENTAL OR CONSEQUENTIAL DAMAGES, SO THE ABOVE LIMITATION OR EXCLUSION MAY NOT APPLY TO THE PURCHASER.

How State and Provincial law apply

This limited warranty gives you specific legal rights, and you may also have other rights which vary from jurisdiction to jurisdiction. The provisions of the United Nations Convention on Contracts for the Sale of Goods shall not apply to this limited warranty or the sale of products covered by this limited warranty.

Replacement Parts List

Log Set	0439070100RP
Flicker Motor	3000240200KIT
Heater Assembly (with cutout)	2000330200RP
On/Off Switch	2800070200RP
Power Cord	4100040300RP
Upper Light Harness	2500400200RP
Lower Light Harness (outer pair)	2500400100RP
Lower Light Socket (center)	2500150200RP
Partially Reflective Glass	5900910100RP
Front Glass	1015270159RP
Remote Control	3001070100RP
Remote Control Receiver	3000880100RP
Remote Switchboard	3000300300RP
Flicker Rod	5901250100RP



Dimplex North America Limited
1367 Industrial Road
Cambridge ON
Canada N1R 7G8

© 2012 Dimplex North America Limited