

# FULL HD

## Vehicle Video Recorder

### User Manual

---



2013 AUG V1.0



---

# Safety Precautions

---

Please Take and review some testing videos initially to make sure the images were recorded correctly.

Please note that manufacturer, its subsidiaries and affiliates, or its distributors are not liable for consequential damages arising from any malfunction of main device accessory, including malfunction memory card that results in the failure of recording video or recorded video ca not be read.

Before using the product, please ensure that you read the safety precautions described below. Always ensure that the product is used correctly.

- Please keep this device away from a children or an infant.
- Use only recommended power sources.
- DO NOT apply multi cigarette lighter adapters-Applying such devices will cause unstable power input. As a result, the vehicle video recorder will shut down or cannot record video due to lost power.
- Please always make sure all power connectors are fully secured.
- Do not attempt to disassemble, alter or apply heat to the product.
- Avoid dropping or subjecting the product to severe impacts.
- To avoid the risk of injury, do not touch the interior of the product if it has been dropped or otherwise damaged.
- Stop using the product immediately if it emits smoke, a strange smell, or otherwise behaves abnormally.
- Do not use organic solvents such as alcohol, benzene, or thinner to clean the product.
- Do not let the product come into contact with water (e.g. sea water) or other liquid.
- Do not allow liquids or foreign objects to enter the Vehicle Video Recorder.
- Do not place the Battery near or in direct flame.
- Do not touch the power cord with a wet hand.
- Do not use the equipment in a manner that exceeds the rated capacity of the electrical outlet or wiring accessories. Do not use if power cord or outlet is damaged, or power cord does not fully inserted into the power outlet.
- Do not allow dirt or metal objects (such as pins or keys) to contact the terminals or plug.
- Avoid using, placing or storing the product in a humid or dusty area.

---

# Index

---

A. Feature Description.....	1
B. Specification .....	2
C. Accessories.....	2
D. Installation Instruction.....	3
E. Product Dimensions .....	5
F. SD Card Installation .....	6
G. Recording / Stop Recording.....	7
H. Remote Controller.....	8
I. OSD Menu function .....	9
J. VACRON Viewer Player .....	10
1. Operation icon introduction.....	10
2. Capture.....	11
3. Configuration .....	11
4. Play back.....	14
5. File backup.....	15
6. Format .....	17
7. Play BAR.....	19
8. Play speed.....	19
9. Volume control.....	19
10. G-SENSOR.....	20
K. Record Time Estimation .....	21

## A. Feature Description

- Full HD Real-time recorder (H.264 compression technology).
- 105° Wide-angle CMOS Lens.
- Record video with sound inside and outside the car.
- Recorded Video store in Micro SD card.
- Loop recording / on start recording when memory card is inserted and device is power on.
- Emergency Manual recording, file save to separate area to prevent overwritten.
- Built-in G-Sensor, auto recording accident footage.
- Made in Taiwan with 3 years warranty.

## B. Specification

Item	Description
Sensor	CMOS Sensor
View Angle	105° Wide-angle
Resolution	Full-HD NTSC 30 fps / PAL 25 fps
V / A	DC5V±5% / 1A. Start voltage 4.6V or above is required.
Operating tmp.	-10°C~ +60°C
Storage	4GB SDHC Card or above (Recommend 『SanDisk』 Class 10 or above)
Recording	Auto recording continuously after power on. Stop recording after power off immediately.
Recording content	Date/Time/Image/Sound/G-Sensor data
Storage Format	Special format, playing by specific Player bundled. Playback by remote control is supported.
Audio Input	Built-in microphone
Time setting	Built-in permanent calendar with adjustable function through bundled Player.
G-Sensor	Built-in 3D G-Sensor

## C. Accessories

Adapter / Remote controller / SD card reader with USB interface / Bracket / cable for converting 4 endpoint, 3.5 inch headphone jack to RCA output / Software CD / Quick user manual

## D. Installation Instruction

1. To install the device on the windshield by " Sucker-type holder " or "Stick-Holder" Type

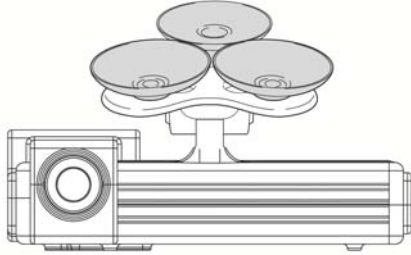

Sucker-type holder

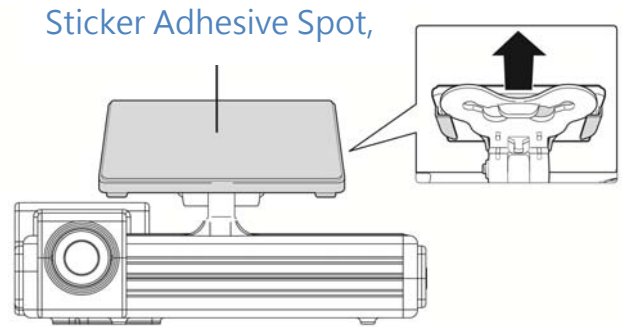

Stick-Holder

2. Install the device on the windshield in the best position

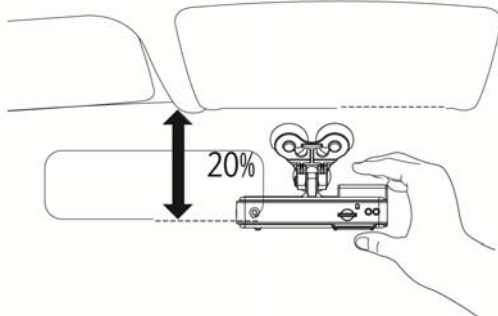

4. Plug in DC5V Power Supply

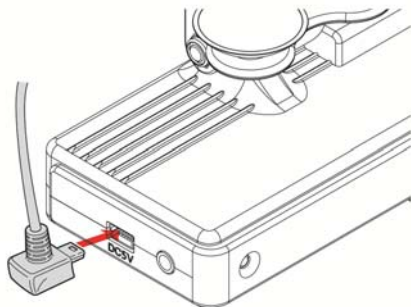

3. To adjust the recording angle properly

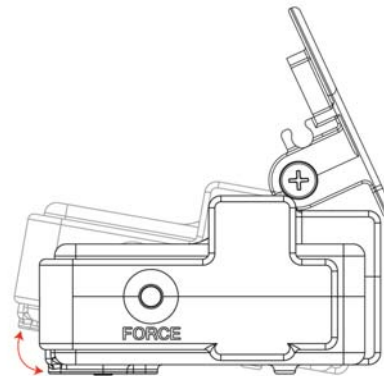

5. Plug in the Cigarette Lighter Adaptor

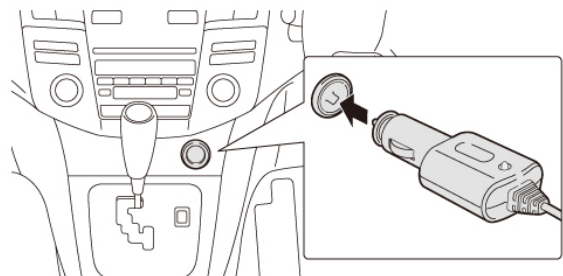

## 6. VVR installation instruction

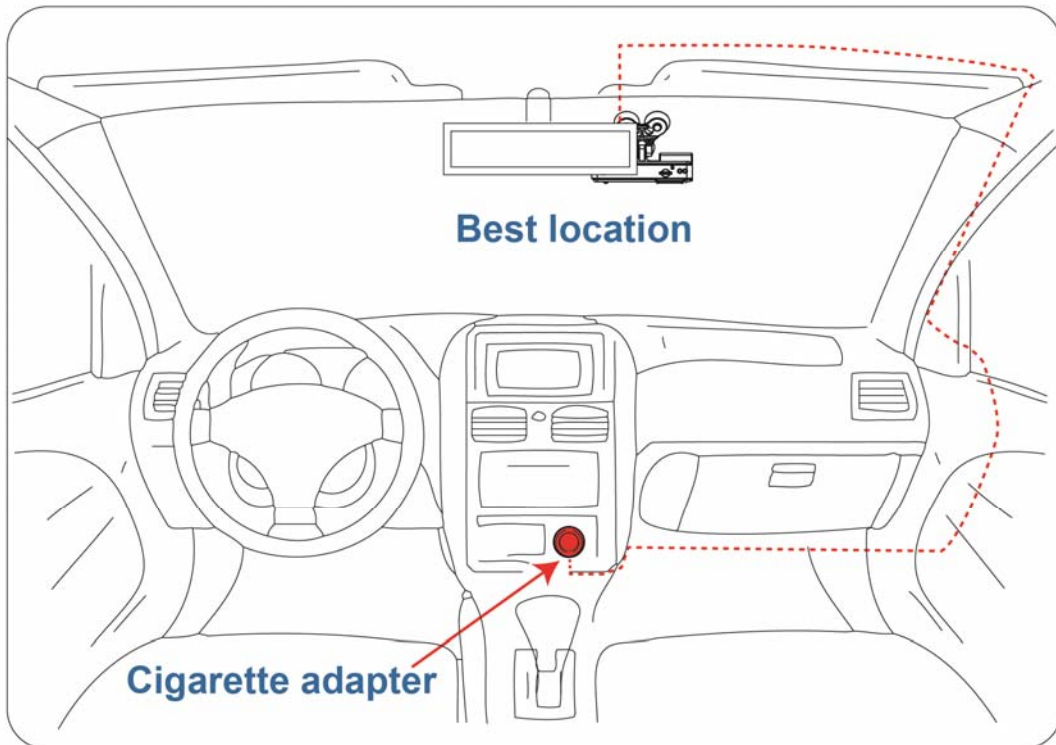

### Caution

- (1). This device should be installed in the area where the Windshield will be able to be cleaned by windshield wiper.
- (2). Formatting SD card on the device before beginning to use.
- (3). Set time zone and timing on OSD. Star the device immediately after you set time zone to make sure the video files will tally with normal time.
- (4). Setting NTSC or PAL through OSD.

## E. Product Dimensions

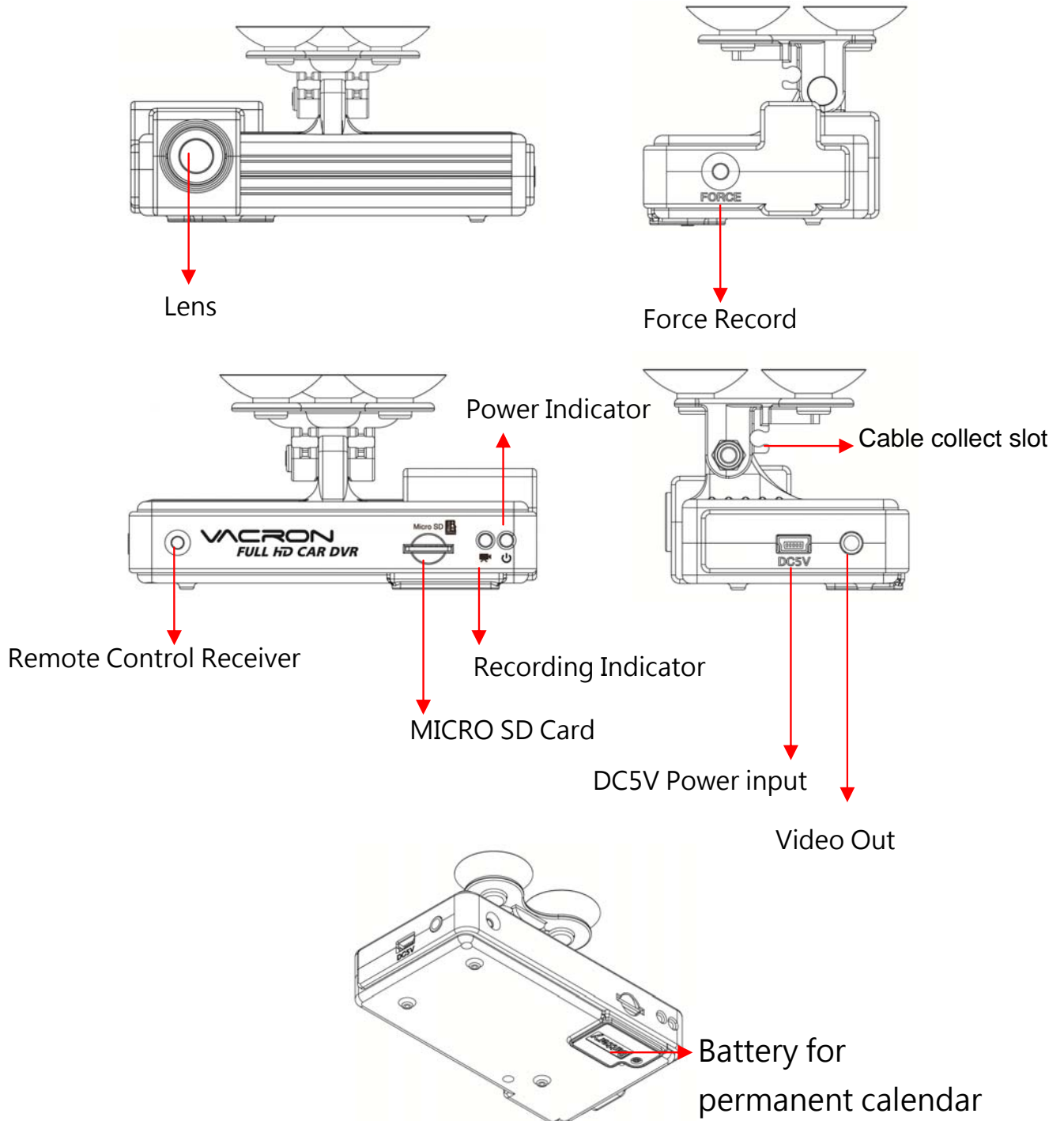



## F. SD Card Installation

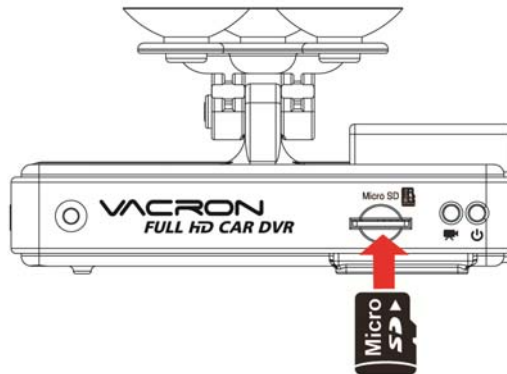

- (1). Format memory card; please refer to the other chapter "Formatting memory card" for more detail.

Remark: Memory Card is optional



### Caution

- (1). Recommend Memory Card "SanDisk" or "Transcend" Class 10 or above Micro SD Card. (Minimum of 4GB)
- (2). If the memory card is not formatted by our exclusive player, the device will automatically erase all the data inside of the memory card after inserting it. Then start recording at default setting.
- (3). Since memory cards have the writing endurance situation, we recommend to inspect the memory card and use pc for playback regularly, to ensure that the memory card can read and write
- (4). Hot swap is not supported. Please power off device before remove memory card. Removing Memory Card while recording may lose or damage recorded data.

## G. Recording / Stop Recording

### 1. Power On/Recording

When car power on, the device start up automatically. Please wait for 30 Sec. to start recording.

### 2. Power Off/Stop recording

When the car power off, the device will stop to record video and sound. You can take off the memory card and insert to computer to view the video.

### 3. Indication

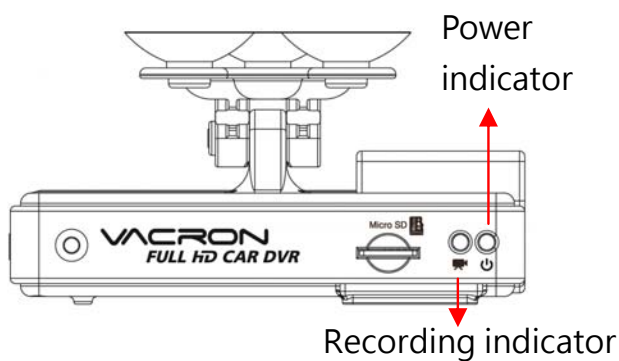

- (1). Recording indicator: Red light Blinking when recording. (Emergency recording blinking fast)
- (2). Power indicator: Green light is ON when power on.



### Caution

- (1). The display of booting screen and live view are subject to change without notice for software upgrade or re-version.
- (2). Force recording button has highest priority. Push Force recording button will pop up recording window and activate force recording immediately.
- (3). CR1220 Battery for calendar can be replaced by users.

## H. Remote Controller

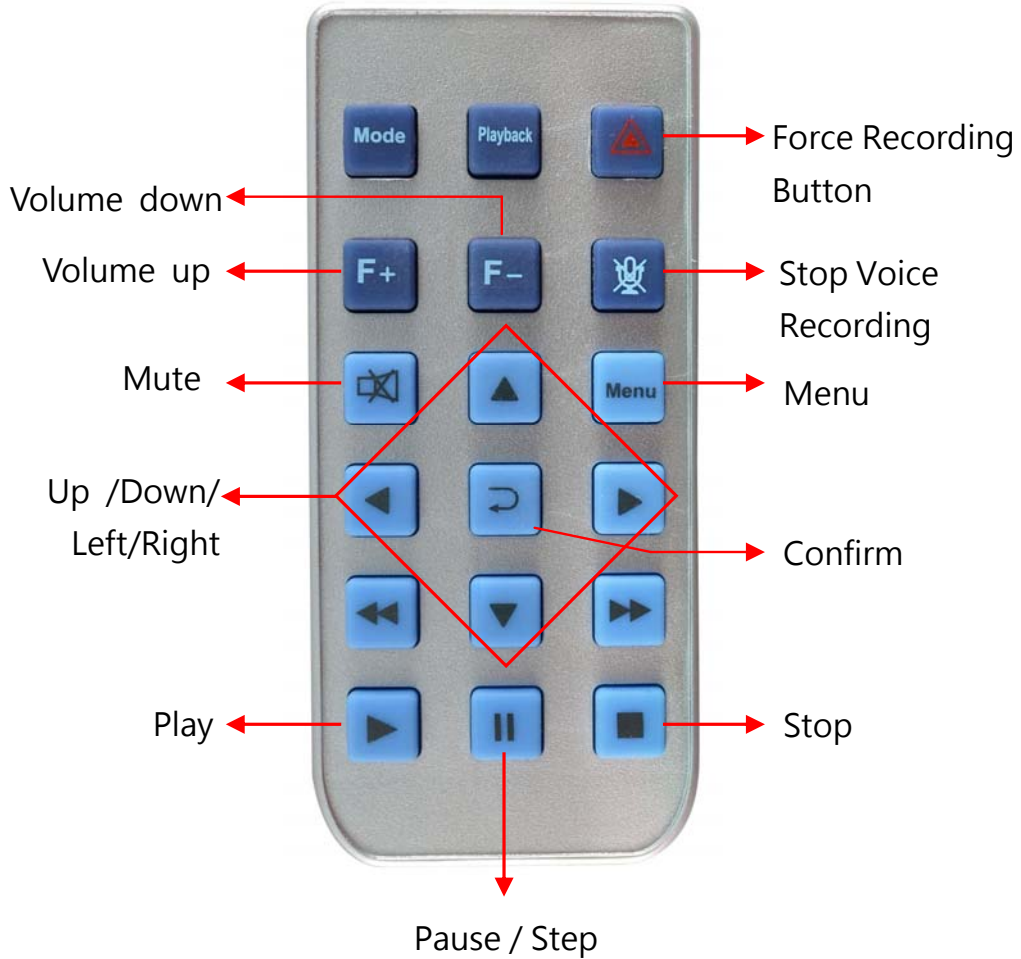

How to check if the remote controller is workable?



- ✓ Check the mercury cell is installed in correct direction. (Check the pole)
- ✓ Check if the cell power is exhaust.
- ✓ Check if the sensor is covered.
- ✓ Check if it nears by Fluorescent Lamp.

## I. OSD Menu function

Remember: Video output require connecting TV OUT line to the device.  
In Live view screen press  on remote controller will popup OSD operation menu as follows:

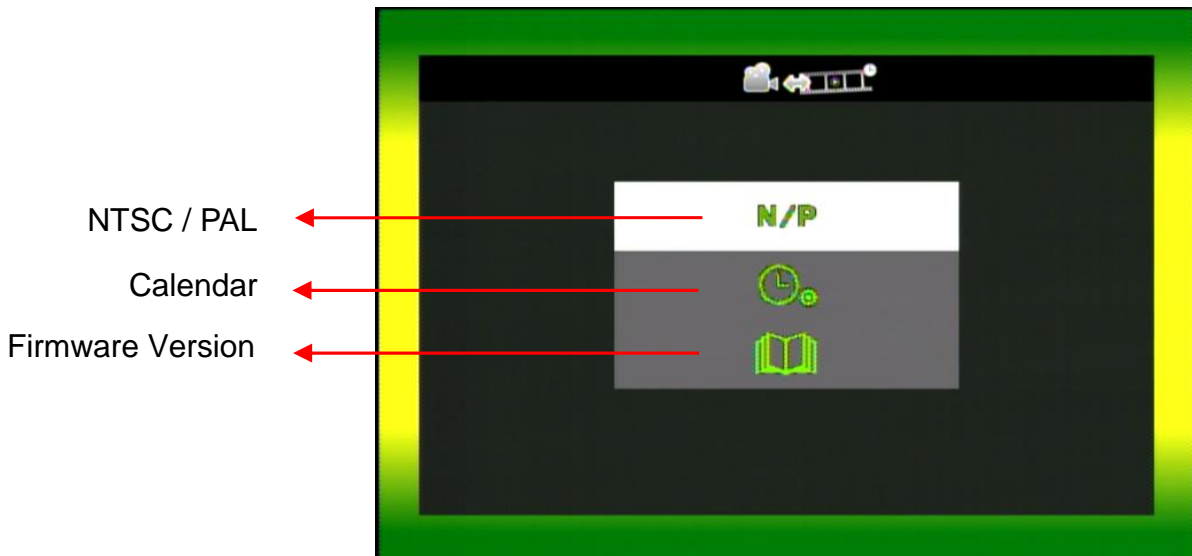







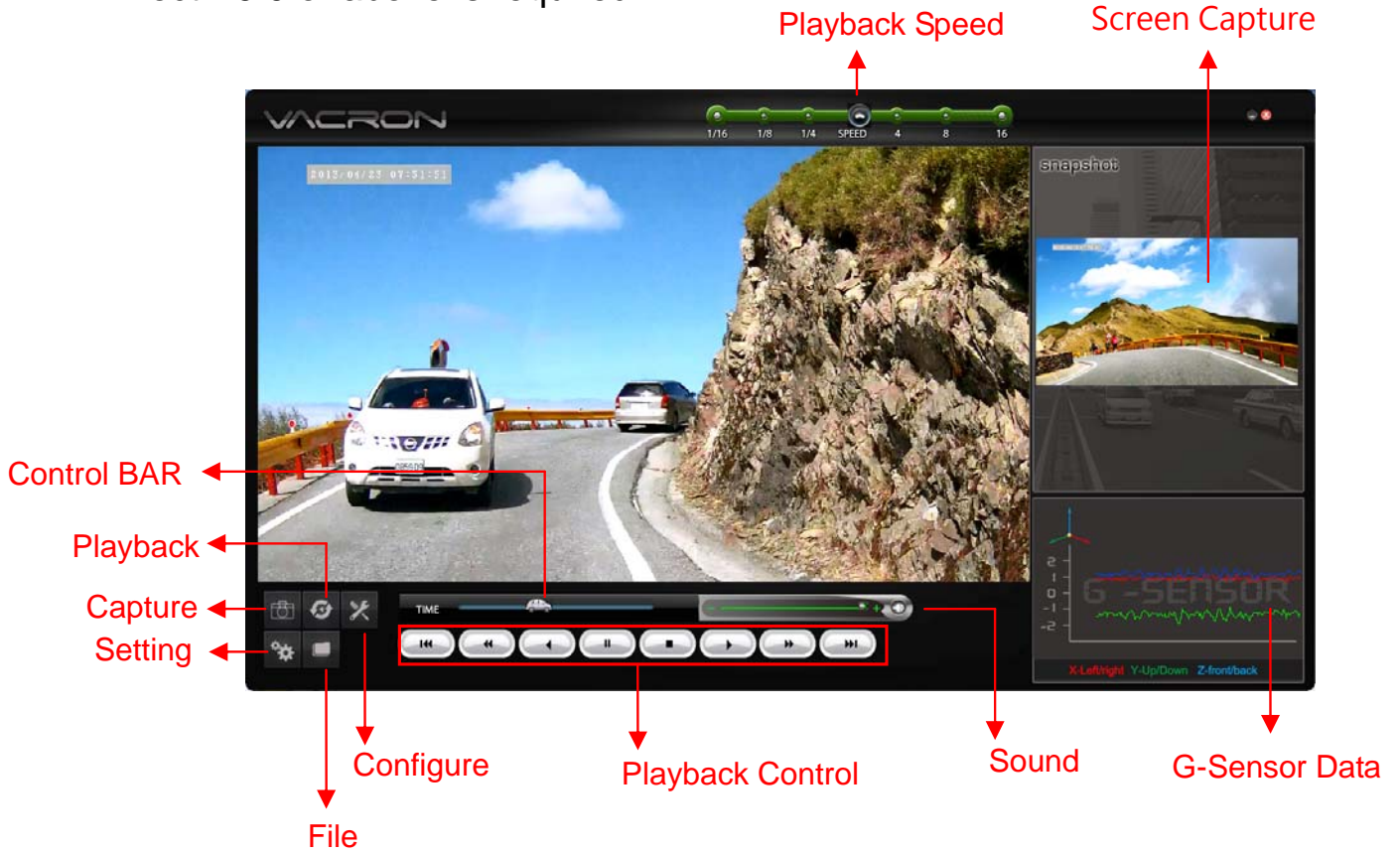

1. Select to export NTSC or PAL signals
2. Select to set built-in clock.
3. Select to view the current firmware version

## J. VACRON Viewer Player

★ DirectX 9.0 or above is required



### 1. Operation icon introduction

	Back to previous file
	Previous image
	Reward
	Pause
	Stop
	Play
	Next image
	Next footage

2.  Capture: Capture the current screen image

You can capture the image when playing the video, click  button to capture the image. The following window will be show. The image you captured will show on the right side. The default Path for saving files is /Snapshot folder, and the file type is \*.bmp.

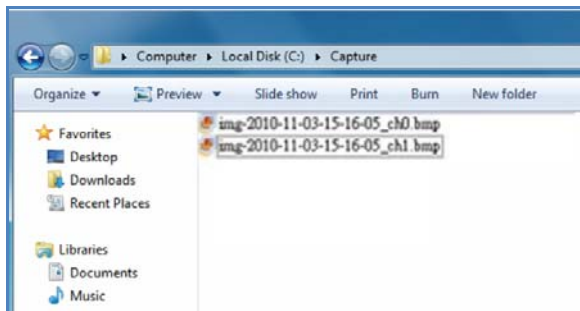

(The Path for saving image files )

SNAPSHOT display area will display image you captured immediately.





(SNAPSHOT show)

3.  Configuration: configure settings according to your demand Attach your memory card reader to PC and insert the memory card to card reader. Run "Viewer" application on PC, configure record format and display

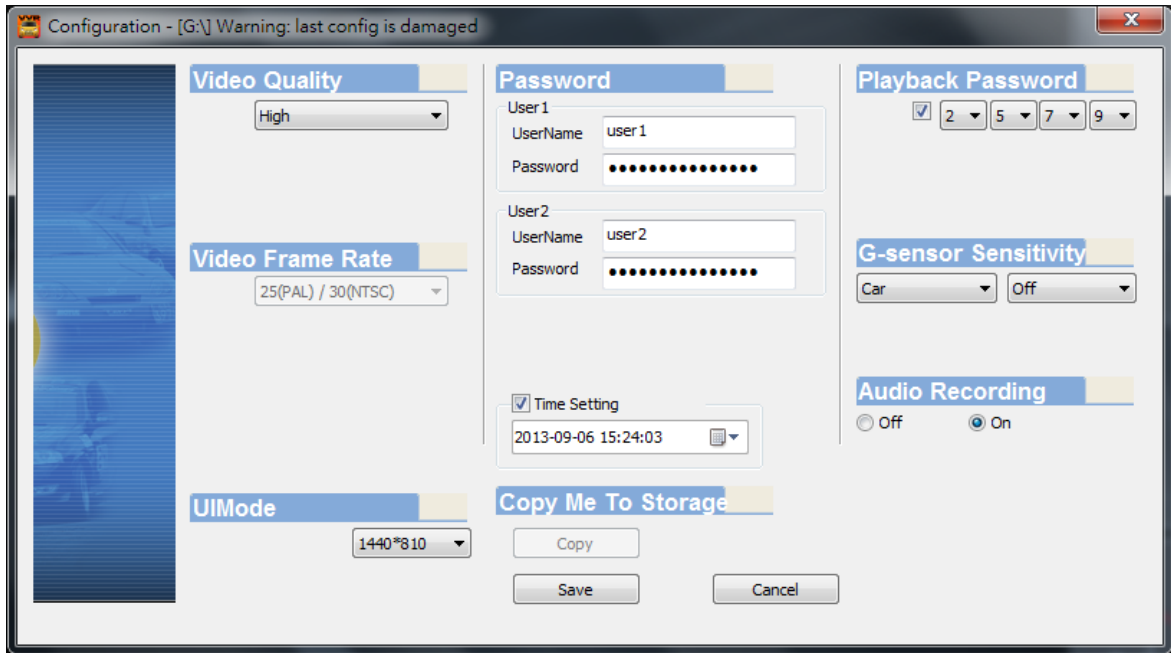

resolution of UI. Then save configuration to memory card. After above processes are completed, the Micro SD card can be insert into the device and start recording according to new setting.

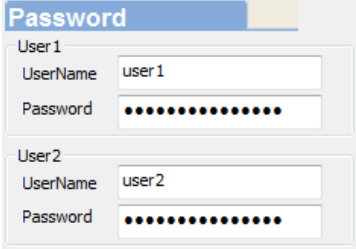
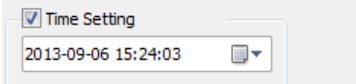
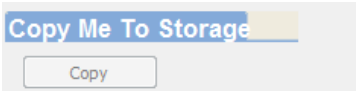

1	Video Quality		Select the video Quality: High/Normal /Low
2	Video Frame Rate		Set recording frame rate for front camera. 25(PAL) / 30(NTSC)
3	UI Mode		The resolution of UI can be adjusted.

4	Password		<p>This function can encrypt the memory card to prevent illegal retrieving from others, the password is under 15 characters, for example:123456789123456</p> <p>After setting the password, it is required to enter password to access the playback file, setting, formatting memory card features.</p> <p>★ Note: Upper/lower case character is different.</p> <p>Take a note for the password and keep in save place is very important.</p>
5	Time Setting		<p>Set correct time and save it to memory card, insert memory card to device immediately to configure correct time on device.</p>
6	Copy the player to SD card		<p>Copy the player to SD card. So bringing this SD card with you, you can play recorded data everywhere, without installing player to PCs.</p>
7	Password for playback		<p>You can set the password. When playback recorded data on the device, the password need to be entered to unlock playback feature</p>

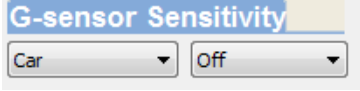

8	G-sensor sensitivity		<p>G-Sensor will detect the abnormal vibrations of the car when Vehicle is running on the road to determine if forced recording should be activated to record the event.</p> <p>Vehicle type and Gensor' s sensitivity can be adjusted.</p> <p>Vehicle type support: Car, Trunk, Motorcycle, Alarm. Each type have 6 mode: OFF, Light, Low, Normal, High, Heavy</p>
9	Audio recording		<p>Audio recording on/off. Open: recording voice / Close: stop voice recording.</p>

4.  Play back: Open file

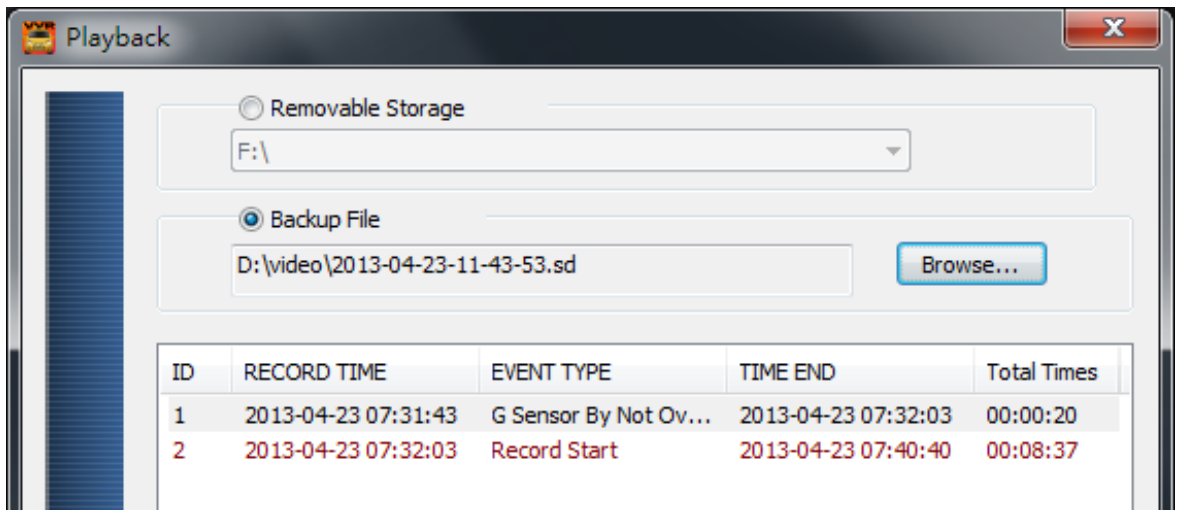

5.  File backup: Files can be backup and save as \*.sd or \*.avi format.

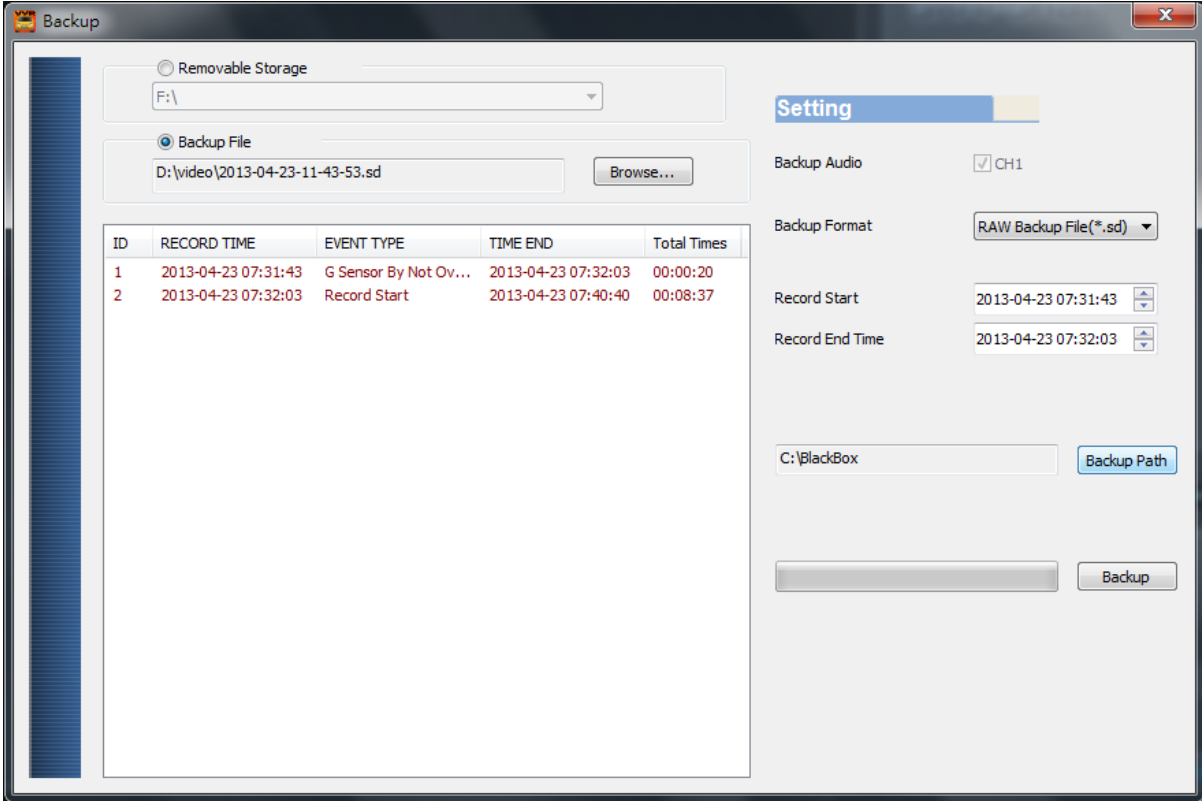

**Step1.** Choose the source of the memory card.

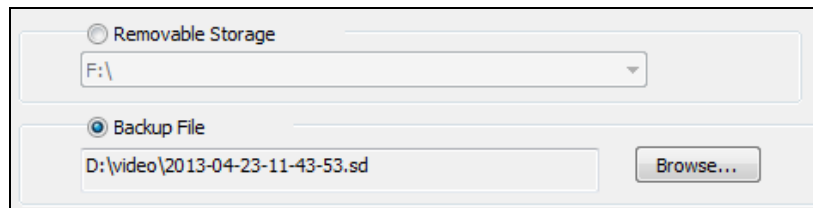

**Step2.** Choose the designated footage to backup.

ID	RECORD TIME	EVENT TYPE	TIME END	Total Times
1	2013-04-23 07:31:43	G Sensor By Not Ov...	2013-04-23 07:32:03	00:00:20
2	2013-04-23 07:32:03	Record Start	2013-04-23 07:40:40	00:08:37

**Step 3.** Choose the target file format and start/end record time.

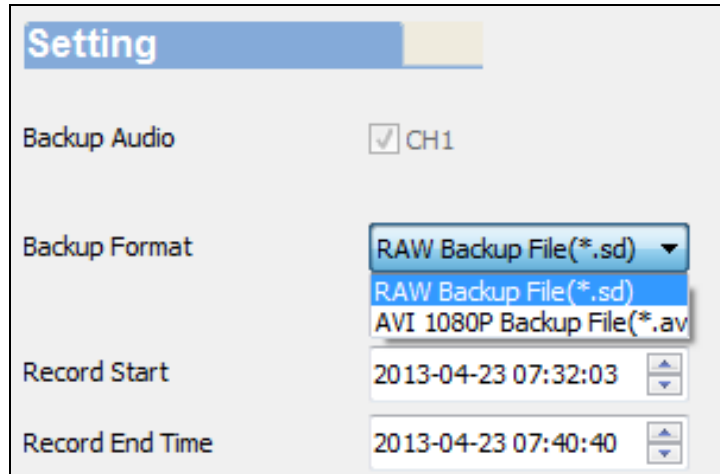

**File format**

(1) Our original file format

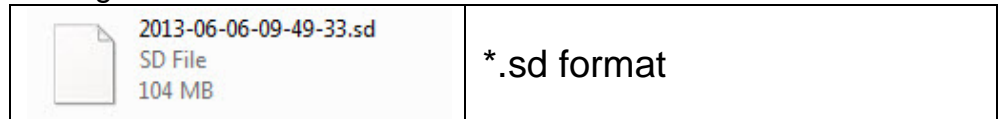

(2) AVI File Backup(\*.avi)

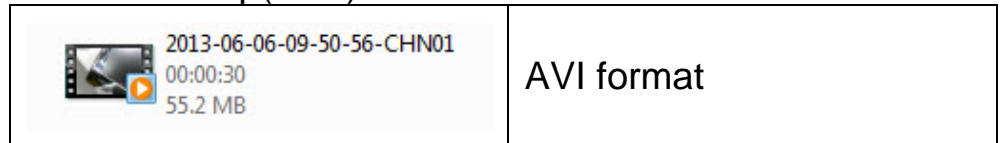

★Note: G-sensor data can only be displayed on manufacturer's player.

**Step 4.** Set the backup folder: default is C:\BlackBox

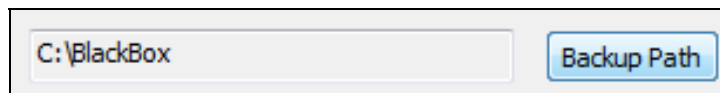

**Step 5.** Start to backup

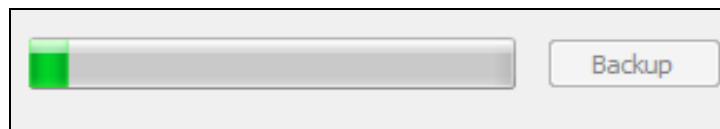

6.  Format: Format memory card/Langue setting

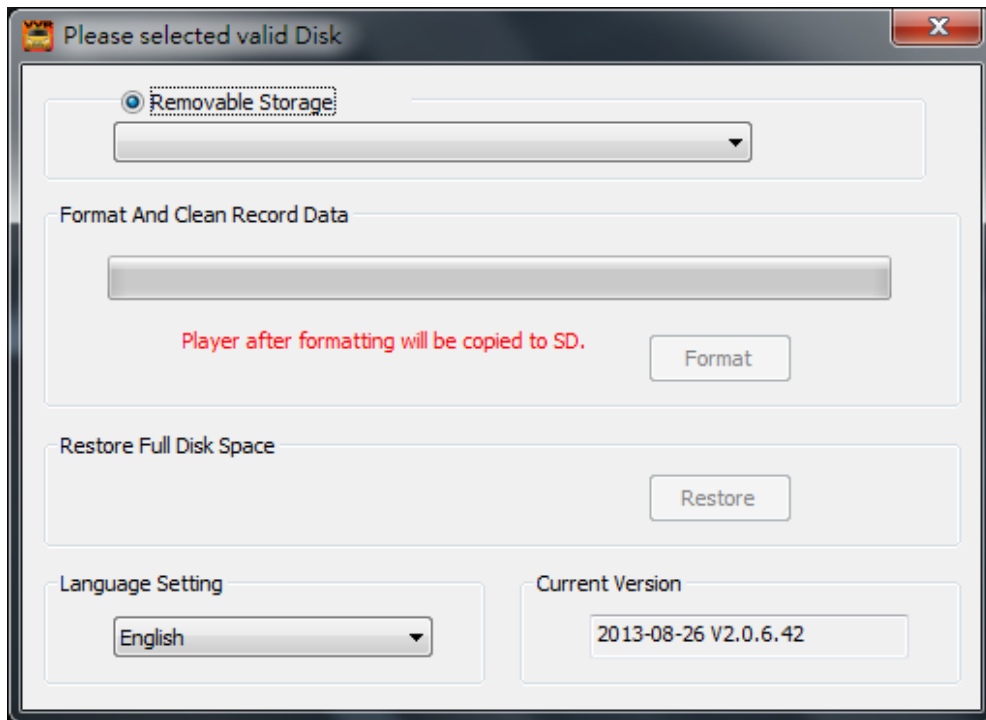

**Caution**

- (1). "Format / Restore" will clean all the data saved on Micro SD card, Please back up the data before proceed " Format /Restore" .
- (2). Before "Format / Restore" Micro SD memory card, please ensure that Micro SD memory card is unlocked.
- (3). If the card is unlocked but still cannot be formatted, this might be caused by Windows security restrictions. Please run the program as Administrator to prevent from this problem.

a、 “Format” Micro SD card

While applying a brand new Micro SD card, or use a Micro SD card that was take out from other devices, a formatting procedure is required.

b、 “Restore” Micro SD card

When the recorded files were back up in your PC and you want to use the Micro SD card for other purposes, you have to restore original disk format first, so it can be used correctly in other devices.

c、 Language setting

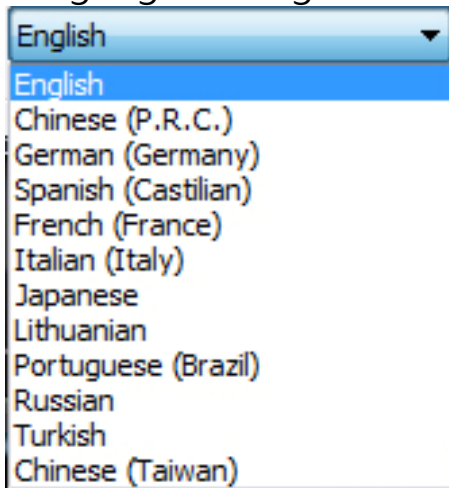

12 languages are supported. Please select a designated language you use.

\* Note: New language setting will take effective after rebooting

d、 Current Version

Current version information will show here. You can decide if you want to upgrade to a new version base on this information. Please visit VACRON web site <http://vvr.vacron.com> to get information about available new firmware release.

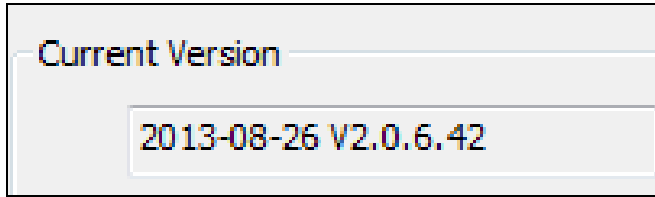

7. Play BAR: You can use Mouse to drag the car icon to move footage location

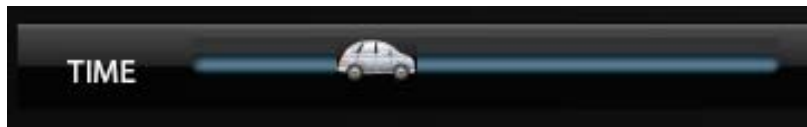

8. Play speed: 4X 、 8X 、 16X and quick playback, 1/4X 、 1/8X 、 1/16X and slow playback.



9. Volume control: Click + 、 - to adjust volume.

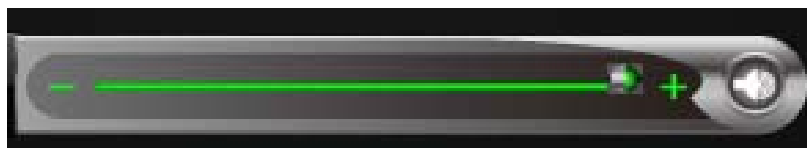

## 10. G-SENSOR

G-Sensor will detect the impact from the car, and record 1-3 minutes footage automatically. This footage will save to separate area to avoid file from being overwritten.



- (1) **X**: Detect vehicle horizontal change.
- (2) **Y**: Detect vehicle vertical change.
- (3) **Z**: Detect vehicle front/back change.

## K. Record Time Estimation

The chart below is for reference only. The length of time recorded can be varied due to variation in image size may be different.

Capacity	8G	16G	32G
Video Quality			
High	120 Min	240 Min	480 Min





---

For More Information  
Please check VACRON Website  
<http://www.vacron.com>

Made in Taiwan

---