



The software of this player may be updated in the future. To find out details on any available updates, please visit: <http://www.sony.com/bluraysupport/>



<http://www.sony.net/>

Printed on 70% or more recycled paper using VOC (Volatile Organic Compound)-free vegetable oil based ink.

4-169-137-13(1)



\*1-4169137133\*

Printed in Malaysia

## Operating Instructions

Blu-ray Disc™ / DVD Player

BDP-S270

# WARNING

To reduce the risk of fire or electric shock, do not expose this apparatus to rain or moisture.

To avoid electrical shock, do not open the cabinet. Refer servicing to qualified personnel only.

The AC power cord must be changed only at a qualified service shop.



Batteries or batteries installed apparatus shall not be exposed to excessive heat such as sunshine, fire or the like.

## CAUTION

The use of optical instruments with this product will increase eye hazard. As the laser beam used in this Blu-ray Disc/DVD player is harmful to eyes, do not attempt to disassemble the cabinet. Refer servicing to qualified personnel only.

CAUTION	CLASS 2R (VISIBLE AND INVISIBLE LASER RADIATION WHEN OPEN, HIGH PULSE) EYE EXPOSURE.
VORSICHT	KLASSE 2R SICHTBARE UND UNSICHTBARE LASERSTRAHLUNG WENN GEÖFFNET, UNMITTELBAREN AUGENKONTAKT VERMEIDEN.
ADVARSEL	SYMBOL OG UDSEENDE LASERSTRÅLING ER KLASSE 2R PULSER, UNDGÅ AT SE DIREKTE PÅ STRÅLEN.
ADVARSEL	SYMBOL OG UDSEENDE LASERSTRÅLING ER KLASSE 2R NÅR DEKSEL ÅPNEES, UNNGÅ DIREKTE ØYEKONTAKT MED STRÅLEN.
VARNING	KLASSE 2R SYNLIG OCH UDSEENDE LASERSTRÅLNING NÄR DEKSEL ÄR ÖPPNAD, UNDVIK ATT ÖBENT EXPOSERA ÖGONEN FÖR STRÅLNINGEN.
VARO!	AUHTONNEN LÖYDÄN SIIRYKÄSIÄN SIIRYKÄSIÄN LASERISÄTÄLÄ, VÄLTÄ KÄIKKÖEN SUOJAA ALUEIDÄMÄITÄ.
警告	打开时有可见和不可见激光辐射，避免眼睛受到直射的照射。

This label is located on the laser protective housing inside the enclosure.

	<b>CAUTION</b> RISK OF ELECTRIC SHOCK DO NOT OPEN	
CAUTION TO REDUCE THE RISK OF ELECTRIC SHOCK, DO NOT REMOVE COVER (OR BACK). NO USER-SERVICEABLE PARTS INSIDE. REFER SERVICING TO QUALIFIED SERVICE PERSONNEL.		



This symbol is intended to alert the user to the presence of uninsulated “dangerous voltage” within the product’s enclosure that may be of sufficient magnitude to constitute a risk of electric shock to persons.



This symbol is intended to alert the user to the presence of important operating and maintenance (servicing) instructions in the literature accompanying the appliance.

## Precautions

- To prevent fire or shock hazard, do not place objects filled with liquids, such as vases, on the apparatus.
- Install this unit so that the AC power cord can be unplugged from the wall socket immediately in the event of trouble.

## FCC WARNING

You are cautioned that any changes or modifications not expressly approved in this manual could void your authority to operate this equipment.

The shielded Interface cable (LAN cable) must be used with the equipment in order to comply with the limits for a digital device pursuant to Subpart B of Part 15 of FCC Rules.



This equipment has been tested and found to comply with the limits for a Class B digital device, pursuant to Part 15 of the FCC Rules. These limits are designed to provide reasonable protection against harmful interference in a residential installation. This equipment generates, uses, and can radiate radio frequency energy and, if not installed and used in accordance with the instructions, may cause harmful interference to radio communications.

However, there is no guarantee that interference will not occur in a particular installation. If this equipment does cause harmful interference to radio or television reception, which can be determined by turning the equipment off and on, the user is encouraged to try to correct the interference by one or more of the following measures:

- Reorient or relocate the receiving antenna.
- Increase the separation between the equipment and receiver.
- Connect the equipment into an outlet on a circuit different from that to which the receiver is connected.
- Consult the dealer or an experienced radio/TV technician for help.

### Owner's Record

The model and serial numbers are located at the rear of the unit. Record the serial number in the space provided below. Refer to them whenever you call upon your Sony dealer regarding this product.

Model No. \_\_\_\_\_  
Serial No. \_\_\_\_\_

### For customers in the USA

If this product is not working properly, please call 1-866-909-7669.

### For Customers in Canada

If this product is not working properly, please contact our **Customer Information Service Center** at 1-877-899-7669 or write to us at: Customer Information Service 115 Gordon Baker Road, Toronto, Ontario, M2H 3R6

### Notes About the Discs

- To keep the disc clean, handle the disc by its edge. Do not touch the surface. Dust, fingerprints, or scratches on the disc may cause it to malfunction.



- Do not expose the disc to direct sunlight or heat sources such as hot air ducts, or leave it in a car parked in direct sunlight as the temperature may rise considerably inside the car.
- After playing, store the disc in its case.
- Clean the disc with a cleaning cloth. Wipe the disc from the center out.



- Do not use solvents such as benzine, thinner, commercially available disc/lens cleaners, or anti-static spray intended for vinyl LPs.
- If you have printed the disc's label, dry the label before playing.
- Do not use the following discs.
  - A lens cleaning disc.
  - A disc that has a non-standard shape (e.g., card, heart).
  - A disc with a label or sticker on it.
  - A disc that has cellophane tape or sticker adhesive on it.



- Do not resurface the playing side of a disc to remove surface scratches.

## Precautions

### On placement

- Place the player in a location with adequate ventilation to prevent heat build-up in the player.
- Do not place the player on a soft surface such as a rug that might block the ventilation holes.
- Do not install this player in a confined space, such as a bookshelf or similar unit.
- Do not place the player in a location near heat sources, or in a place subject to direct sunlight, excessive dust, or mechanical shock.
- Do not place the player outdoors, in vehicles, on ships, or on other vessels.
- If the player is brought directly from a cold to a warm location, or is placed in a very damp room, moisture may condense on the lenses inside the player. Should this occur, the player may not operate properly. In this case, remove the disc and leave the player turned on for about half an hour until the moisture evaporates.
- Do not install the player in an inclined position. It is designed to be operated in a horizontal position only.
- Do not place heavy or unstable objects on the player.
- Do not place any objects other than discs on the disc tray. Doing so may cause damage to the player or the object.
- Take out any discs when you move the player. If you don't, the disc may be damaged.
- Disconnect the AC power cord and all other cables from the player when you move the player.

### On power sources

- The player is not disconnected from the AC power source as long as it is connected to the wall outlet, even if the player itself has been turned off.
- Disconnect the player from the wall outlet if you are not going to use the player for a long time. To disconnect the AC power cord, grasp the plug itself; never pull the cord.
- Observe following points to prevent the AC power cord being damaged. Do not use the AC power cord if it is damaged, as doing so may result in an electric shock or fire.
  - Do not pinch the AC power cord between the player and wall, shelf, etc.
  - Do not put anything heavy on the AC power cord or pull on the AC power cord itself.

### On adjusting volume

Do not turn up the volume while listening to a section with very low level inputs or no audio signals. If you do, your ears and the speakers may be damaged when a peak level section is played.

## On cleaning

Clean the cabinet, panel, and controls with a soft cloth. Do not use any type of abrasive pad, scouring powder or solvent such as alcohol or benzene.

## On cleaning discs, disc/lens cleaners

Do not use cleaning discs or disc/lens cleaners (including wet or spray types). These may cause the apparatus to malfunction.

## On replacement of parts

In the events that this player is repaired, repaired parts may be collected for reuse or recycling purposes.

## On connecting to the HDMI OUT jack

Observe the following as improper handling may damage the HDMI OUT jack and the connector.

- Carefully align the HDMI OUT jack on the rear of the player and the HDMI connector by checking their shapes. Make sure the connector is not upside down or tilted.

HDMI OUT

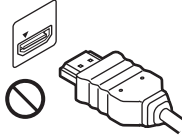

HDMI OUT

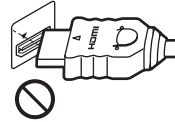

- Be sure to disconnect the HDMI cable when moving the player.



- Hold the HDMI connector straight when connecting or disconnecting the HDMI cable. Do not twist or force the HDMI connector into the HDMI OUT jack.

## IMPORTANT NOTICE

Caution: This player is capable of holding a still video image or on-screen display image on your television screen indefinitely. If you leave the still video image or on-screen display image displayed on your TV for an extended period of time you risk permanent damage to your television screen. Plasma display panel televisions and projection televisions are susceptible to this.

If you have any questions or problems concerning your player, please consult your nearest Sony dealer.

## Important Safety Instructions

- 1) Read these instructions.
  - 2) Keep these instructions.
  - 3) Heed all warnings.
  - 4) Follow all instructions.
  - 5) Do not use this apparatus near water.
  - 6) Clean only with dry cloth.
  - 7) Do not block any ventilation openings. Install in accordance with the manufacturer's instructions.
  - 8) Do not install near any heat sources such as radiators, heat registers, stoves, or other apparatus (including amplifiers) that produce heat.
  - 9) Do not defeat the safety purpose of the polarized or grounding-type plug. A polarized plug has two blades with one wider than the other. A grounding type plug has two blades and a third grounding prong. The wide blade or the third prong are provided for your safety. If the provided plug does not fit into your outlet, consult an electrician for replacement of the obsolete outlet.
  - 10) Protect the power cord from being walked on or pinched particularly at plugs, convenience receptacles, and the point where they exit from the apparatus.
  - 11) Only use attachments/ accessories specified by the manufacturer.
  - 12) Use only with the cart, stand, tripod, bracket, or table specified by the manufacturer, or sold with the apparatus. When a cart is used, use caution when moving the cart/ apparatus combination to avoid injury from tip-over.
- 
- 13) Unplug this apparatus during lightning storms or when unused for long periods of time.
  - 14) Refer all servicing to qualified service personnel. Servicing is required when the apparatus has been damaged in any way, such as power-supply cord or plug is damaged, liquid has been spilled or objects have fallen into the apparatus, the apparatus has been exposed to rain or moisture, does not operate normally, or has been dropped.

# Table of Contents

WARNING .....	2
Precautions .....	4
Guide to Parts and Controls .....	8

---

## Hookups and Settings

Step 1: Preparing the Player .....	11
Step 2: Connecting the Player .....	12
Step 3: Easy Setup .....	14
Connecting to the Network .....	14

---

## Playback

Playing a Disc .....	16
Playing from a USB Device .....	17
Playing via a Network .....	18
Available Options .....	18

---

## Settings and Adjustments

Using the Settings Displays .....	20
Network Update .....	21
Screen Settings .....	21
Audio Settings .....	23
BD/DVD Viewing Settings .....	24
Parental Control Settings .....	24
System Settings .....	25
Network Settings .....	26
Easy Setup .....	26
Resetting .....	26

---

## Additional Information

Troubleshooting .....	27
Specifications .....	30
Index .....	35

# Guide to Parts and Controls

## Front panel

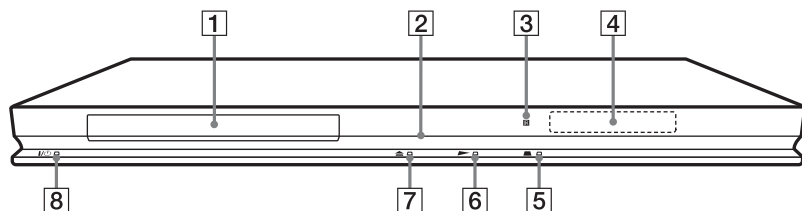

The ► button has a tactile dot. Use the tactile dot as a reference when operating the player.

**1 Disc tray**

**2 Power indicator**

Lights up in white when the player is turned on.

**3 Remote sensor**

**4 Front panel display**

►, ■: Lights up during playback or pause.

↺: Lights up when enabling the repeat setting.

HD: Lights up when outputting 720p/1080i/1080p video signals.

**5 ■ (stop)**

**6 ► (play)**

**7 ▲ (open/close)**

**8 I/⏻ (on/standby)**

Turns on the player, or sets to standby mode.

### To lock the disc tray (Child Lock)

You can lock the disc tray to prevent it being opened by mistake.

When the player is turned on, hold down ► on the player for more than 10 seconds. The disc tray is locked or unlocked.

## Rear panel

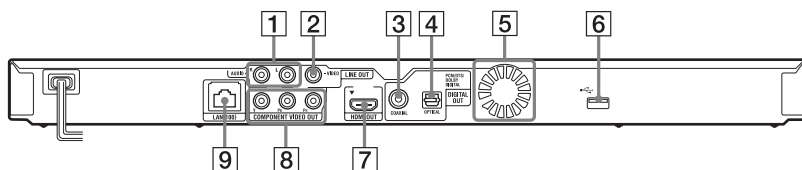

**1 LINE OUT (R-AUDIO-L) jacks**

**2 LINE OUT (VIDEO) jack**

**3 DIGITAL OUT (COAXIAL) jack**

**4 DIGITAL OUT (OPTICAL) jack**

**5 Ventilation holes**

**6 ⚡ (USB) jack**

**7 HDMI OUT jack**

**8 COMPONENT VIDEO OUT (Y, P<sub>B</sub>, P<sub>R</sub>) jacks**

**9 LAN (100) terminal**



## Remote

The available functions of the remote differ depending on the disc or the situation.

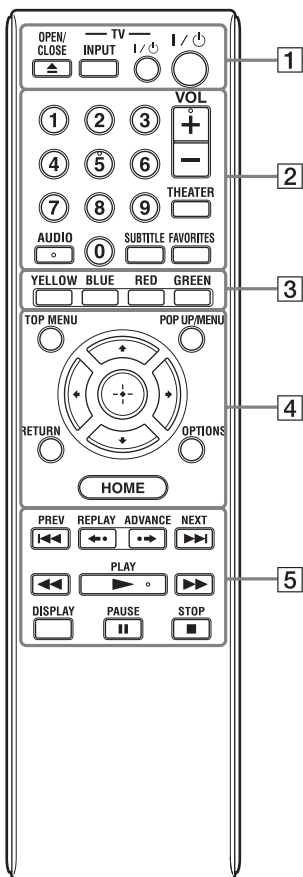

Number 5, AUDIO, VOL +, and ► PLAY buttons have a tactile dot. Use the tactile dot as a reference when operating the player.

### The player automatically returns to standby mode

If any button on the player or remote is not pressed for more than 30 minutes, the player automatically returns to standby mode.

#### 1 ▲ OPEN/CLOSE

Opens or closes the disc tray.

#### -TV- INPUT

Switches between TV and other input sources.

#### -TV- I/⏻ (on/standby)

Turns on the TV, or sets to standby mode.

#### I/⏻ (on/standby)

Turns on the player, or sets to standby mode.

#### 2 [Number buttons (0 - 9)]

Enters the title/chapter numbers, etc.

#### VOL +/-

Adjusts the TV volume.

#### THEATER (page 32)

Switches to the optimum video mode for watching movies automatically.

The THEATER button functions only when connected to a Sony Theater Mode-compatible AV amplifier (receiver) or Sony Theater Mode-compatible TV.

#### AUDIO (page 24)

Selects the language track when multi-lingual tracks are recorded on BD-ROMs/DVD VIDEOS.

Selects the sound track on CDs.

#### SUBTITLE (page 24)

Selects the subtitle language when multi-lingual subtitles are recorded on BD-ROMs/DVD VIDEOS.

#### FAVORITES (page 18)

Displays the Internet content added to the Favorites List. You can save up to 18 of your favorite Internet content programs.

#### 3 [Color buttons (YELLOW/BLUE/RED/GREEN)]

Short cut keys for interactive functions.

#### 4 TOP MENU

Opens or closes the BD's or DVD's Top Menu.

#### POP UP/MENU

Opens or closes the BD-ROM's Pop-up Menu, or the DVD's menu.

#### OPTIONS (page 18)

The options menu that can be selected appears on the screen.

## HOME

Enters the player's home menu.  
Displays the wall paper when pressed on the category icon of the home menu.

## RETURN

Returns to the previous display.



Moves the highlight to select a displayed item.

## Center button (ENTER)

Enters the selected item.

## 5 ◀◀ PREV/NEXT ▶▶

Skips to the previous/next chapter, track, or file.

## ◀◀ REPLAY/ADVANCE ▶▶

Briefly replays the current scenes for 10 seconds/briefly fast forwards the current scenes for 15 seconds.

## ◀◀/▶▶ (fast reverse/fast forward)

- Fast reverses/fast forwards the disc when pressed during playback. Each time you press the button during playback of videos, the search speed changes.
- Plays in slow motion, when ▶▶ is pressed for more than one second in pause mode.
- Plays one frame at a time, when ▶▶ is pressed briefly in pause mode.

## ▶▶ PLAY

Starts or re-starts playback.

## DISPLAY (page 17)

Displays the playback information on the screen.

## || PAUSE

Pauses or re-starts playback.

## ■ STOP

Stops playback and remembers the stop point (resume point).

The resume point for a title/track is the last point you played or the last photo for a photo folder.

## Home menu display

The home menu appears when you press HOME. Select a category using ◀/▶. Select an item using ↑/↓, and press ENTER.

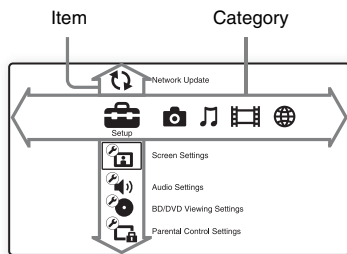

- (Setup): Adjusts the player settings.
- (Photo): Displays photos.
- (Music): Plays music.
- (Video): Plays videos.
- (Network): Displays network items.

## Hookups and Settings

### Step 1: Preparing the Player

#### Checking the supplied accessories

Check that you have the following items:

- Audio/video cable (phono plug x3) (1)
- Remote commander (remote) (1)
- Size AA (R6) batteries (2)

#### Preparing the remote

Insert two Size AA (R6) batteries by matching the ⊕ and ⊖ ends on the batteries to the markings inside the battery compartment.

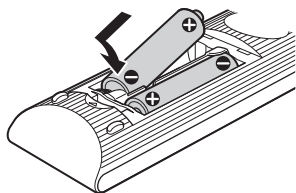

# Step 2: Connecting the Player

Do not connect the AC power cord until you have made all the connections.

## Connecting to your TV

Select one of the following connection methods according to the input jacks on your TV. Match the color of the plug to that of the jack when connecting.

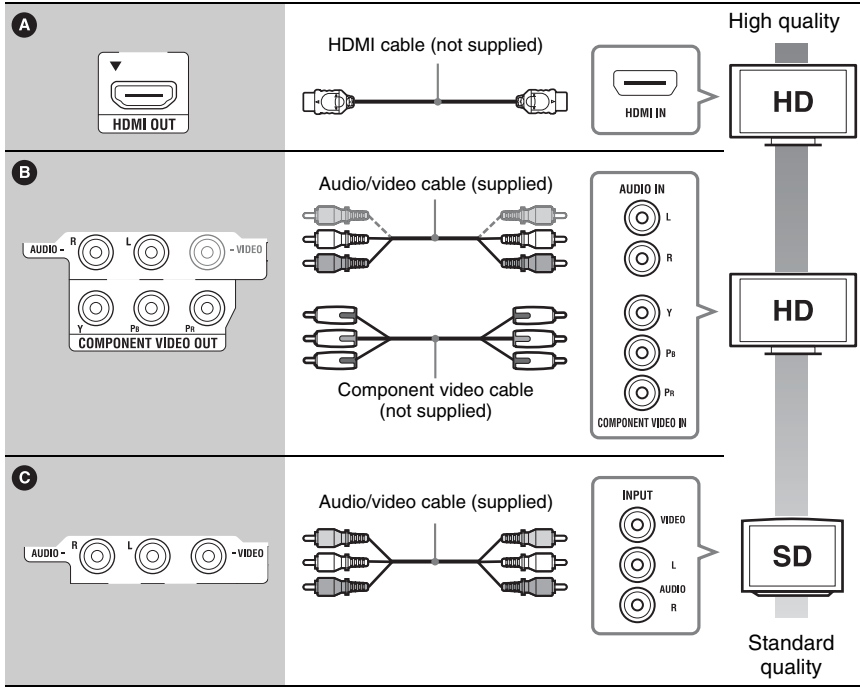
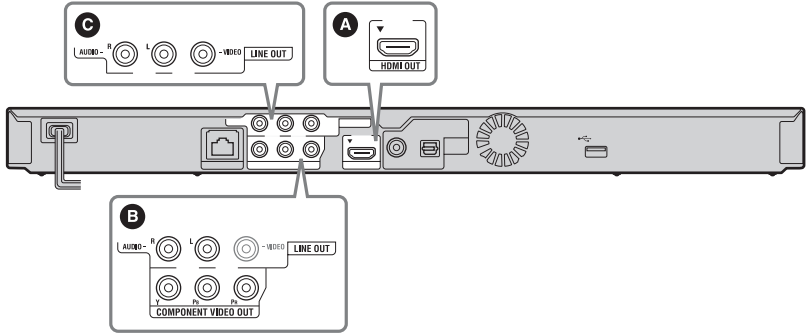



**⚡** Do not connect the player through a VCR. Video signals fed through VCRs may be affected by copyright protection systems and the picture will be distorted on the television.

## Connecting to your AV amplifier (receiver)

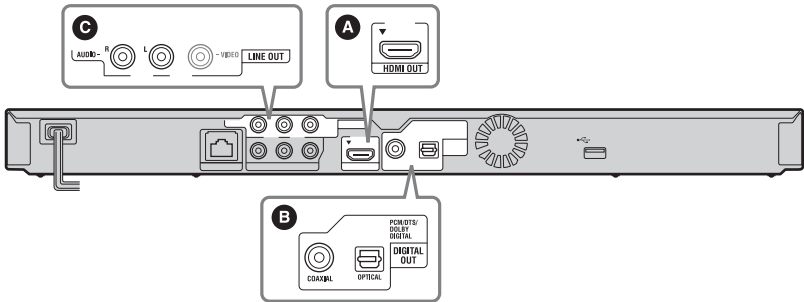
Select one of the following connection methods according to the input jacks on your AV amplifier (receiver). When you select **A** or **B**, make the appropriate settings in the “Audio Settings” setup (page 23).

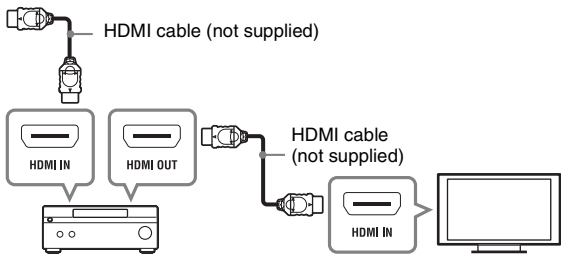
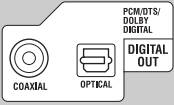
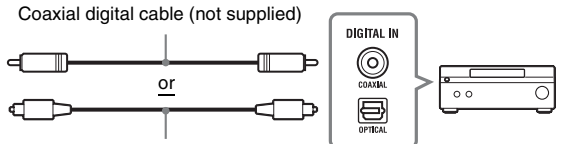

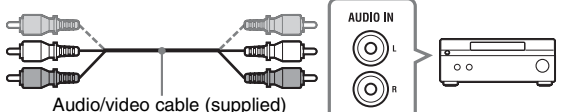
<p><b>A</b></p> 	 <p>HDMI cable (not supplied)</p> <p>→ Set “BD Audio MIX Setting” (page 23).</p>
<p><b>B</b></p> 	 <p>Coaxial digital cable (not supplied)</p> <p>or</p> <p>Optical digital cable (not supplied)</p> <p>→ Set “Dolby Digital (Coaxial / Optical)<sup>*1</sup>” (page 23) and “DTS (Coaxial / Optical)<sup>*2</sup>” (page 23).</p>
<p><b>C</b></p> 	 <p>Audio/video cable (supplied)</p>

<sup>\*1</sup> Manufactured under license from Dolby Laboratories.  
Dolby, Pro Logic, and the double-D symbol are trademarks of Dolby Laboratories.

<sup>\*2</sup> Manufactured under license under U.S. Patent #'s: 5,451,942; 5,956,674; 5,974,380; 5,978,762; 6,226,616; 6,487,535; 7,212,872; 7,333,929; 7,392,195; 7,272,567 & other U.S. and worldwide patents issued & pending. DTS is a registered trademark and the DTS logos, Symbol, DTS-HD and DTS-HD Master Audio are trademarks of DTS, Inc.  
© 1996-2008 DTS, Inc. All Rights Reserved.

## Step 3: Easy Setup

### When turned on for the first time

Wait for a short while before the player turns on and starts “Easy Setup”.

### 1 Plug the player into the AC outlet.



### 2 Press I/⏻ to turn on the player.

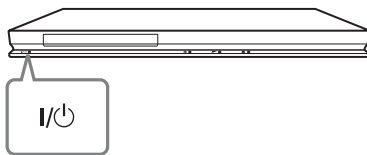

### 3 Turn on the TV, then switch the input selector on your TV so that the signal from the player appears on your TV screen.

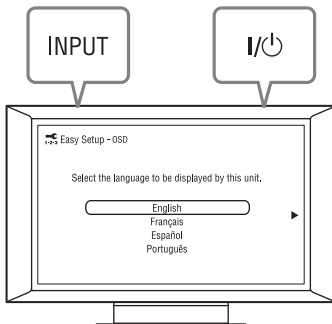

### 4 Perform “Easy Setup.”

Follow the on-screen instructions to make the basic settings using ←/↑/↓/→ and ENTER on the remote.

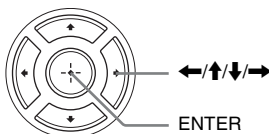

## Connecting to the Network

### Wired Setup

Use a LAN cable to connect to the LAN (100) terminal on the player.

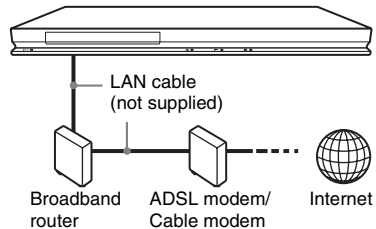

### To set the network settings

Select “Network Settings,” “Internet Settings,” then “Wired Setup” (page 26), and follow the on-screen instructions to complete the setup.

### USB Wireless Setup

Turn off the player, then connect the USB Wireless LAN Adapter (UWA-BR100 only available as of January 2010) to the USB jack on the player.



The USB Wireless LAN Adapter may not be available in some regions/countries.

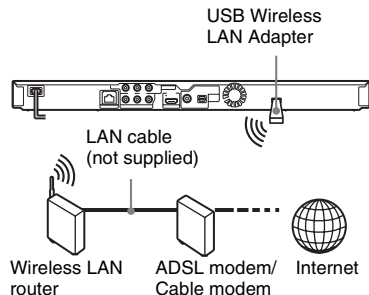

**To set the network settings**

Select “Network Settings,” “Internet Settings,” then “USB Wireless Setup” (page 26), and follow the on-screen instructions to complete the setup.

## Playback

### Playing a Disc

For playable discs, see “Playable discs” (page 30).

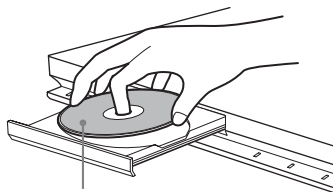

- 1** Switch the input selector on your TV so that the signal from the player appears on your TV screen.
- 2** Press **▲ OPEN/CLOSE**, and place a disc on the disc tray.



Playing side facing down

- 3** Press **▲ OPEN/CLOSE** to close the disc tray.

● appears on the home menu and playback starts.

If playback does not start automatically, select ● in the  (Video),  (Music), or  (Photo) category, and press ENTER.

### Enjoying BONUSVIEW/BD-LIVE

Some BD-ROMs with the “BD-LIVE” logo\* have bonus content and other data that can be downloaded for enjoyment.

\*  BD-LIVE™

- 1** Connect a USB memory to the USB jack on the rear of the player (page 8).  
As your local storage, use a 1 GB or larger USB memory.
- 2** Prepare for BONUSVIEW/BD-LIVE.
  - Connect the player to a network (page 14).
  - Set “BD Internet Connection” to “Allow” (page 24).



### 3 Insert a BD-ROM with BONUSVIEW/ BD-LIVE.

The operation method differs depending on the disc. Refer to the instruction manual supplied with the disc.



To delete data in the USB memory, select “Erase BD Data” in the (Video), and press ENTER. All data stored in the buda/budb folder will be erased.

## Displaying the play information

You can check the playback information, etc., by pressing DISPLAY. The displayed information differs depending on the disc type and player status.

Example: when playing a BD-ROM

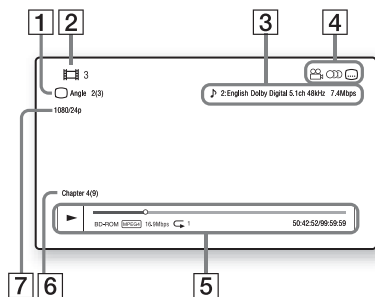

- 1 The currently selected angle
- 2 Title number or name
- 3 The currently selected audio setting
- 4 Available functions ( angle, audio, subtitle)
- 5 Playback information  
Displays the Play mode, Playing status bar, Disc type, Video codec, Bitrate, and Repeat type.
- 6 Chapter number
- 7 Output resolution/Video frequency

## Playing from a USB Device

You can play video/music/photo files on the connected USB device.

For playable USB devices, see “Playable types of files” (page 31).

### 1 Connect the USB device to the USB jack on the player.

Refer to the instruction manual supplied with the USB device before connecting.

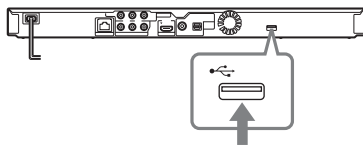







### 2 Select (Video), (Music), or (Photo) on the home menu using /

### 3 Select (USB device) using /

## Playing via a Network

### Streaming BRAVIA Internet Video

Serves as a gateway delivering the selected Internet content and a variety of on-demand entertainment straight to your player.





- 1 Prepare for BRAVIA Internet Video.**  
Connect the player to a network (page 14).
- 2 Select  (Video),  (Music), or  (Photo) on the home menu using / .**
- 3 Select an Internet content provider icon using / , and press ENTER.**  
When an Internet content list has not been acquired, an unacquired icon or a new icon is displayed.

### To use the control panel

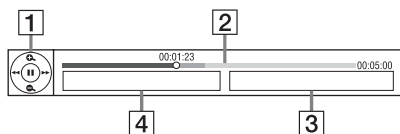
The control panel appears when the video file starts playing. The displayed items may differ depending on Internet content providers.

To display again, press DISPLAY.



- 1 Control display**  
Press / / /  or ENTER for playback operations.
- 2 Playing status bar**  
Status bar, Cursor indicating the current position, Playing time, Duration of the video file
- 3 The next video file name**
- 4 The currently selected video file name and rating**

## Available Options

Various settings and playback operations are available by pressing OPTIONS. The available items differ depending on the situation.

### Common options

Items	Details
Repeat Setting	Sets the repeat mode.
Favorites List	Displays the Favorites List.
Play/Stop	Starts or stops the playback.
Play from beginning	Plays the item from the beginning.
Add to Favorites	Adds Internet content to the Favorites List.
Remove from Favorites	Removes Internet content from the Favorites List.

### (Video) only

Items	Details
AV SYNC	Adjusts the gap between picture and sound, by delaying the sound output in relation to the picture output (0 to 120 milliseconds).
Video Settings	Picture Quality Mode: Selects the picture settings for different lighting environments.
Play/Pause	Starts or pauses the playback.
Top Menu	Displays the BD's or DVD's Top Menu.
Menu/Pop-up Menu	Displays the BD-ROM's Pop-up Menu or DVD's menu.
Title Search	Searches for a title on BD-ROMs/DVD VIDEOS and starts playback from the beginning.
Chapter Search	Searches for a chapter and starts playback from the beginning.
Angle	Switches to other viewing angles when multi-angles are recorded on BD-ROMs/DVD VIDEOS.





 (Photo) only









Items	Details
Slideshow Speed	Changes the slideshow speed.
Slideshow	Plays a slideshow.
Rotate Left	Rotates the photo counterclockwise by 90 degrees.
Rotate Right	Rotates the photo clockwise by 90 degrees.

## Settings and Adjustments

# Using the Settings Displays

Select  (Setup) on the home menu when you need to change the settings of the player. The default settings are underlined.

- 1 Select  (Setup) on the home menu using /.
- 2 Select the setup category icon using /, and press ENTER.

Icon	Explanation
	<b>Network Update (page 21)</b> Updates the software of the player.
	<b>Screen Settings (page 21)</b> Makes the video settings according to the type of connecting jacks.
	<b>Audio Settings (page 23)</b> Makes the audio settings according to the type of connecting jacks.
	<b>BD/DVD Viewing Settings (page 24)</b> Makes detailed settings for BD/DVD playback.
	<b>Parental Control Settings (page 24)</b> Makes detailed settings for the Parental Control function.
	<b>System Settings (page 25)</b> Makes the player-related settings.
	<b>Network Settings (page 26)</b> Makes detailed settings for the Internet and network.
	<b>Easy Setup (page 26)</b> Re-runs the Easy Setup to make the basic settings.
	<b>Resetting (page 26)</b> Resets the player to the factory settings.

## Network Update

Select “OK” to update the player’s software via the network.



- We recommend the network update every 2 months or so.
- For information about update functions, visit the following website:  
<http://www.sony.com/bluraysupport/>

## Screen Settings



### TV Type

<u>16:9</u>	Select this when connecting to a wide-screen TV or a TV with a wide mode function.
4:3	Select this when connecting to a 4:3 screen TV without a wide mode function.

### Screen Format

<u>Original</u>	Select this when connecting to a TV with a wide mode function. Displays a 4:3 screen picture in 16:9 aspect ratio even on a wide-screen TV.
Fixed Aspect Ratio	Changes the picture size to fit the screen size with the original picture aspect ratio.

### DVD Aspect Ratio

<u>Letter Box</u>	Displays a wide picture with black bands on the top and bottom. 
Pan & Scan	Displays a full-height picture on the entire screen, with trimmed sides. 

## Cinema Conversion Mode

<u>Auto</u>	Normally select this. The player automatically detects whether the material is video-based or film-based, and switches to the appropriate conversion method.
Video	The conversion method suited for video-based material will always be selected regardless of the material.

## Output Video Format

HDMI	Normally select “Auto.” Select “Original Resolution” to output the resolution recorded on the disc. When the resolution is lower than the SD resolution, it is scaled up to the SD resolution.
Component Video	Select the resolution that suits your TV.
<u>Video</u>	Automatically sets the lowest resolution.



- When connecting the HDMI OUT jack and other video output jacks at the same time, select “Component Video.”
- If no picture appears when setting “HDMI” or “Component Video” resolution, try another resolution setting.

## BD/DVD-ROM 1080/24p Output

<u>Auto</u>	Outputs 1920 × 1080p/24 Hz video signals only when connecting a 1080/24p-compatible TV using the HDMI OUT jack.
Off	Select this when your TV is not compatible with 1080/24p video signals.

## YCbCr/RGB (HDMI)

<u>Auto</u>	Automatically detects the connected TV type, and switches to the matching color setting.
YCbCr (4:2:2)	Outputs YCbCr 4:2:2 video signals.
YCbCr (4:4:4)	Outputs YCbCr 4:4:4 video signals.
RGB	Outputs RGB video signals.

## HDMI Deep Color Output

<u>Auto</u>	Normally select this.
12bit	Outputs 12bit/10bit video signals when the connected TV is compatible with Deep Color.
10bit	
Off	Select this when the picture is unstable or colors appear unnatural.

## Pause Mode

<u>Auto</u>	Normally select this. Dynamic moving pictures appear without blurring.
Frame	Displays static pictures at high resolution.

## Audio Settings

### Audio (HDMI)

<u>Auto</u>	Normally select this. Outputs audio signals according to the status of the connected HDMI device.
PCM	Outputs PCM signals from the HDMI OUT jack.

### BD Audio MIX Setting

<u>On</u>	Outputs the audio obtained by mixing the interactive and secondary audio to the primary audio.
Off	Outputs the primary audio only. Select this to output HD audio signals to an AV amplifier (receiver).

### Dolby Digital (Coaxial / Optical)

Downmix PCM	Converts to output Linear PCM signals. Select this when connecting an audio device without a built-in Dolby Digital decoder.
<u>Dolby Digital</u>	Select this when connecting an audio device with a built-in Dolby Digital decoder.

### DTS (Coaxial / Optical)

Downmix PCM	Converts to output Linear PCM signals. Select this when connecting to an audio device without a built-in DTS decoder.
<u>DTS</u>	Select this when connecting to an audio device with a built-in DTS decoder.

### Audio DRC

<u>Auto</u>	Performs playback at the dynamic range specified by the disc (BD-ROM only). Other discs are played back at the "Standard" level.
Standard	Performs playback at a standard compression level.
Wide Range	No compression works. A more dynamic sound is produced.

### Downmix

<u>Surround</u>	Outputs audio signals with surround effects. Select this when connecting an audio device that supports Dolby Surround (Pro Logic) or DTS Neo 6.
Stereo	Outputs audio signals without surround effects. Select this when connecting an audio device that does not support Dolby Surround (Pro Logic) or DTS Neo 6.

## **BD/DVD Viewing Settings**

### **BD/DVD Menu**

Selects the default menu language for BD-ROMs or DVD VIDEOS.

When you select “Select Language Code,” the display for entering the language code appears. Enter the code for your language by referring to “Language code list” (page 34).

### **Audio**

Selects the default track language for BD-ROMs or DVD VIDEOS.

When you select “Original,” the language given priority in the disc is selected. When you select “Select Language Code,” the display for entering the language code appears. Enter the code for your language by referring to “Language code list” (page 34).

### **Subtitle**

Selects the default subtitle language for BD-ROMs or DVD VIDEOS.

When you select “Select Language Code,” the display for entering the language code appears. Enter the code for your language by referring to “Language code list” (page 34).

### **BD Hybrid Disc Playback Layer**

<u>BD</u>	Plays BD layer.
DVD/CD	Plays DVD or CD layer.

### **BD Internet Connection**

Allow	Normally select this.
<u>Do not allow</u>	Prohibits Internet connection.

## **Parental Control Settings**

### **Password**

Sets or changes the password for the Parental Control function. A password allows you to set a restriction on BD-ROM or DVD VIDEO, and Internet video playback. If necessary, you can differentiate the restriction levels for BD-ROMs, DVD VIDEOS, and Internet videos.

### **Parental Control Area Code**

Playback of some BD-ROMs, DVD VIDEOS, or Internet videos can be limited according to the geographic area. Scenes may be blocked or replaced with different scenes. Follow the on-screen instructions and enter your four-digit password.

### **BD Parental Control**

Playback of some BD-ROMs can be limited according to the age of the users. Scenes may be blocked or replaced with different scenes. Follow the on-screen instructions and enter your four-digit password.

### **DVD Parental Control**

Playback of some DVD VIDEOS can be limited according to the age of the users. Scenes may be blocked or replaced with different scenes. Follow the on-screen instructions and enter your four-digit password.

### **Internet Video Parental Control**

Playback of some Internet videos can be limited according to the age of the users. Scenes may be blocked or replaced with different scenes. Follow the on-screen instructions and enter your four-digit password.

### **Internet Video Unrated**

<u>Allow</u>	Allows the playback of unrated Internet videos.
Block	Blocks the playback of unrated Internet videos.



## System Settings

### OSD

Selects your language for the player on-screen displays.

### Dimmer

<u>Bright</u>	Bright lighting.
Dark	Low lighting.
Off	Turns off the lighting during playback. Low lighting other than during playback.

### Control for HDMI

<u>On</u>	Allows you to use the "Control for HDMI" function (page 32).
Off	Turns off the function.

### Quick Start Mode

On	Shortens the startup time when turning on the player.
<u>Off</u>	Reduces standby power consumption.

### Auto Display

<u>On</u>	Automatically displays information on the screen when changing the viewing titles, picture modes, audio signals, etc.
Off	Displays information only when you press DISPLAY.

### Screen Saver

<u>On</u>	Turns on the screen saver function. The screen saver image appears when you do not use the player for more than 10 minutes while an on-screen display is displayed.
Off	Turns off the function.

### Software Update Notification

<u>On</u>	Sets the player to inform you of newer software version information (page 21).
Off	Turns off the function.

### System Information

Displays the player's software version information and the MAC address.



## Network Settings

### Internet Settings

Connect the player to the network beforehand. For details, see “Connecting to the Network” (page 14).

View Network Status	Displays the current network status.
<u>Wired Setup</u>	Select this when you connect to a broadband router directly.
USB Wireless Setup	Select this when you use a USB Wireless LAN Adapter. For further details, visit the following website and check the FAQ contents: <a href="http://www.sony.com/bluraysupport/">http://www.sony.com/bluraysupport/</a>

### Network Connection Diagnostics

You can run the network diagnostic to check if the network connection has been made properly.



## Easy Setup

Re-runs the “Easy Setup” to make the basic settings. Follow the on-screen instructions.



## Resetting

### Reset to Factory Default Settings

You can reset the player settings to the factory default by selecting the group of settings. All the settings within the group will be reset.

### Initialize Personal Information

You can erase your personal information stored in the player.

## Additional Information

# Troubleshooting

If you experience any of the following difficulties while using the player, use this troubleshooting guide to help remedy the problem before requesting repairs. Should any problem persist, consult your nearest Sony dealer.

## Picture

### **There is no picture or the picture is not output correctly.**

- ➔ Check that all the connecting cables are securely connected (page 12).
- ➔ Switch the input selector on your TV to display the signal from the player.
- ➔ Reset the video output resolution to the lowest resolution by pressing ■ on the player for more than 10 seconds.
- ➔ For HDMI connections, try the following:
  - ① Turn the player off and on again.
  - ② Turn the connected equipment off and on again.
  - ③ Disconnect and then reconnect the HDMI cable.
- ➔ The HDMI OUT jack is connected to a DVI device that does not support copyright protection technology.
- ➔ For HDMI connections, check the “Output Video Format” settings in the “Screen Settings” setup (page 22).
- ➔ When the analog signals are also output, set “BD/DVD-ROM 1080/24p Output” to “Off” in the “Screen Settings” setup (page 22).
- ➔ For BD-ROMs, check the “BD/DVD-ROM 1080/24p Output” setting in the “Screen Settings” setup (page 22).

### **The display language on the screen switches automatically when connected to the HDMI OUT jack.**

- ➔ When “Control for HDMI” is set to “On” (page 25), the display language on the screen automatically switches according to the language setting of the connected TV (if you change the setting on your TV, etc.).

## Sound

### **There is no sound or the sound is not output correctly.**

- ➔ Check that all the connecting cables are securely connected (page 12).
- ➔ Switch the input selector on your AV amplifier (receiver) so that the audio signals of the player are output from your AV amplifier (receiver).
- ➔ If the audio signal does not come through the DIGITAL OUT (OPTICAL/COAXIAL)/HDMI OUT jack, check the audio settings (page 23).
- ➔ For HDMI connections, try the following:
  - ① Turn the player off and on again.
  - ② Turn the connected equipment off and on again.
  - ③ Disconnect and then reconnect the HDMI cable.
- ➔ For HDMI connections, if the player is connected to a TV through an AV amplifier (receiver), try connecting the HDMI cable directly to the TV. Refer also to the instruction manual supplied with the AV amplifier (receiver).
- ➔ The HDMI OUT jack is connected to a DVI device (DVI jacks do not accept audio signals).
- ➔ The device connected to the HDMI OUT jack does not support the audio format of the player. Check the audio settings (page 23).

---

### **The HD Audio (Dolby Digital Plus, Dolby TrueHD, DTS-HD High Resolution Audio, and DTS-HD Master Audio) is not output by bitstream.**

- ➔ Set “BD Audio MIX Setting” to “Off” in the “Audio Settings” setup (page 23).
- ➔ Check that the connected AV amplifier (receiver) is compatible with each HD Audio format.

---

### **The interactive audio is not output.**

- ➔ Set “BD Audio MIX Setting” to “On” in the “Audio Settings” setup (page 23).

## Disc

### **The disc does not play.**

- ➔ The disc is dirty or skewed.
- ➔ The disc is upside down. Insert the disc with the playback side facing down.
- ➔ The disc has a format that cannot be played back by this player (page 30).
- ➔ The player cannot play a recorded disc that is not correctly finalized.
- ➔ The region code on the BD or DVD does not match the player.

## USB device

### **The player does not detect a USB device connected to the player.**

- ➔ Make sure that the USB device is securely connected to the USB jack.
- ➔ Check if the USB device or a cable is damaged.
- ➔ Check if the USB device is on.
- ➔ If the USB device is connected via a USB hub, connect the USB device directly to the player.

## BRAVIA Internet Video

### **The picture/sound is poor/certain programs display a loss of detail, especially during fast-motion or dark scenes.**

- ➔ Picture/sound quality may be poor depending on Internet content providers.
- ➔ Picture/sound quality may be improved by changing the connection speed. We recommend the connection speed of at least 2.5 Mbps for standard definition video (10 Mbps for high definition video).
- ➔ Not all videos will contain sound.

---

### **The picture is small.**

- ➔ Press **↑** to zoom in.

## Network connection

### The player cannot connect to the network.

- ➔ Check the network connection (page 14) and the network settings (page 26).

### The message “A new software version has been found on the network. Perform update under “Network Update.”” appears on the screen when turning the player on.

- ➔ See “Network Update” (page 21) to update the player to a newer software version.

## BRAVIA Sync (“Control for HDMI”)

### The “Control for HDMI” function does not work (BRAVIA Sync).

- ➔ Check that “Control for HDMI” is set to “On” (page 25).
- ➔ If you change the HDMI connection, turn the player off and on again.
- ➔ If power failure occurs, set “Control for HDMI” to “Off,” then set “Control for HDMI” to “On” (page 25).
- ➔ Check the following and refer to the instruction manual supplied with the component.
  - the connected component is compatible with the “Control for HDMI” function.
  - the connected component’s setting for the “Control for HDMI” function is correct.
- ➔ When you connect the player to a TV through an AV amplifier (receiver),
  - if the AV amplifier (receiver) is not compatible with the “Control for HDMI” function, you may be unable to control the TV from the player.
  - if you change the HDMI connection, disconnect and reconnect the AC power cord, or a power failure occurs, try the following:
    - ① Switch the input selector of the AV amplifier (receiver) so that the picture from the player appears on the TV screen.
    - ② Set “Control for HDMI” to “Off,” then set “Control for HDMI” to “On” (page 25). Refer to the instruction manual supplied with the AV amplifier (receiver).

## Others

### Playback does not start from the beginning of content.

- ➔ Press **OPTIONS**, and select “Play from beginning.”

### Playback does not start from the resume point where you last stopped playing.

- ➔ The resume point may be cleared from memory depending on the disc when
  - you open the disc tray.
  - you disconnect the USB device.
  - you play other content.
  - you turn off the player.

### The disc tray does not open and “LOCKED” or “TLK ON” appears on the front panel display.

- ➔ When “LOCKED” appears, the player is locked. To cancel the Child Lock, hold down **▶** on the player until “UNLOCK” appears on the front panel display (page 8).
- ➔ When “TLK ON” appears, contact your Sony dealer or local authorized Sony service facility.

### The disc tray does not open and you cannot remove the disc even after you press **▲**.

- ➔ Try the following:
  - ① Turn the player off, and disconnect the AC power cord.
  - ② Reconnect the AC power cord while pressing down **▲** on the player.
  - ③ Keep pressing down **▲** on the player until the tray opens.
  - ④ Remove the disc.
  - ⑤ When “OPEN” appears on the front panel display, hold down **I/⏻** on the player for more than 10 seconds until the player turns off.

### “Exxxxx” or “FAN ERR” appears on the front panel display.

- ➔ When “Exxxxx” appears, contact your nearest Sony dealer or local authorized Sony service facility and give the error code.

- ➔ When “FAN ERR” appears, try the following: ①Check that the ventilation holes on the rear of the player are not blocked. ②Place the player in a location with adequate ventilation to prevent heat build-up in the player.

### The player does not respond to any button.

- ➔ Moisture has condensed inside the player (page 4).
- ➔ Hold down **I/⏻** on the player for more than 10 seconds until the indicators on the front panel display turn off.  
If the player still does not respond to any button, disconnect then reconnect the AC power cord.

## Specifications

### System

**Laser:** Semiconductor laser

### Inputs and outputs

**(Jack name:**

Jack type/Output level/Load impedance)

**LINE OUT R-AUDIO-L:**

Phono jack/2 Vrms/10 kilohms

**DIGITAL OUT (OPTICAL):**

Optical output jack/−18 dBm  
(wave length 660 nm)

**DIGITAL OUT (COAXIAL):**

Phono jack/0.5 Vp-p/75 ohms

**HDMI OUT:**

HDMI 19-pin standard connector

**COMPONENT VIDEO OUT (Y, P<sub>B</sub>, P<sub>R</sub>):**

Phono jack/Y: 1.0 Vp-p/  
P<sub>B</sub>, P<sub>R</sub>: 0.7 Vp-p/75 ohms

**LINE OUT VIDEO:**

Phono jack/1.0 Vp-p/75 ohms

**LAN (100):**

100BASE-TX Terminal

**USB:**

USB jack Type A (For connecting a USB memory, memory card reader, digital still camera, and digital video camera)

### General

**Power requirements:**

120 V AC, 60 Hz

**Power consumption:**

18 W

**Dimensions (approx.):**

430 mm × 219 mm × 36 mm

(17 in. × 8 5/8 in. × 1 7/16 in.)

(width/depth/height) incl. projecting parts

**Mass (approx.):**

2.0 kg (4 lb 6 1/2 oz)

**Operating temperature:**

5 °C to 35 °C (41 °F to 95 °F)

**Operating humidity:**

25 % to 80 %

### Supplied accessories

See page 11.

Specifications and design are subject to change without notice.

### Playable discs

<b>Blu-ray Disc</b> *1	BD-ROM BD-R*2/BD-RE*2
<b>DVD</b> *3	DVD-ROM DVD-R/DVD-RW DVD+R/DVD+RW
<b>CD</b> *3	CD-DA (Music CD) CD-ROM CD-R/CD-RW

\*1 Since the Blu-ray Disc specifications are new and evolving, some discs may not be playable depending on the disc type and the version. The audio output differs depending on the source, connected output jack, and selected audio settings.

\*2 BD-RE: Ver.2.1

BD-R: Ver.1.1, 1.2, 1.3 including organic pigment type BD-R (LTH type)

The BD-Rs recorded on a PC cannot be played if postscripts are recordable.

\*3 A CD or DVD disc will not play if it has not been correctly finalized. For more information, refer to the instruction manual supplied with the recording device.

## Discs that cannot be played

- BDs with cartridge
- DVD-RAMs
- HD DVDs
- DVD Audio discs
- PHOTO CDs
- Data part of CD-Extras
- VCDs/Super VCDs
- Audio material side on DualDiscs
- A disc recorded in a color system other than NTSC, such as PAL (this player conforms to the NTSC color system).

## Note on Discs

This product is designed to playback discs that conform to the Compact Disc (CD) standard. DualDiscs and some of the music discs encoded with copyright protection technologies do not conform to the Compact Disc (CD) standard, therefore, these discs may not be playable by this product.

## Note on playback operations of BDs/DVDs

Some playback operations of BDs/DVDs may be intentionally set by software producers. Since this player plays BDs/DVDs according to the disc contents the software producers designed, some playback features may not be available.

## Note about double-layer BDs/DVDs

The playback pictures and sound may be momentarily interrupted when the layers switch.

## Region code (BD-ROM/DVD VIDEO only)

Your player has a region code printed on the rear of the unit and will only play BD-ROMs/DVD-ROMs labeled with identical region codes or .

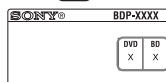

Region code

## Playable types of files

### Video

File format	Extensions
MPEG-1 Video/PS <sup>*1</sup>	“.mpg,” “.mpeg,”
MPEG-2 Video/PS, TS <sup>*1</sup>	“.m2ts,” “.mts”

File format	Extensions
MPEG-4 AVC <sup>*1</sup>	“.mkv,” “.mp4,” “.m4v,” “.m2ts,” “.mts”
WMV9 <sup>*1</sup>	“.wmv,” “.asf”
AVCHD	<sup>*2</sup>

### Music

File format	Extensions
MP3 (MPEG-1 Audio Layer III)	“.mp3”
AAC <sup>*1*3</sup>	“.m4a”
WMA9 Standard <sup>*1*3</sup>	“.wma”
LPCM	“.wav”

### Photo

File format	Extensions
JPEG	“.jpg,” “.jpeg”

<sup>\*1</sup> The player does not play coded files such as DRM.

<sup>\*2</sup> The player plays AVCHD format files that are recorded on a digital video camera, etc. The AVCHD format disc will not play if it has not been correctly finalized.

<sup>\*3</sup> The player does not play coded files such as Lossless.



- Some files may not play depending on the format, the encoding, or recording condition.
- Some files edited on a PC may not play.
- The player can recognize the following files or folders in BDs, DVDs, CDs and USB devices:
  - up to folders in the 5th tree
  - up to 500 files in a single tree
- Some USB devices may not work with this player.
- The player can recognize Mass Storage Class (MSC) devices (such as flash memory or an HDD) that are FAT-compatible and non-partitioned, and Still Image Capture Device (SICD) class devices.
- To avoid data corruption or damage to the USB memory or devices, turn the player off when connecting or removing the USB memory or devices.
- The player may not play high bit rate video files on DATA CDs smoothly. You are recommended to play such files using DATA DVDs.

## About the BRAVIA Sync features (for HDMI connections only)

By connecting Sony components that are compatible with the “Control for HDMI” function with an HDMI cable (not supplied), operation is simplified as below:

- **One-Touch Play**  
With one touch of the following buttons, the connected TV turns on and the input selector on the TV is switched to the player automatically.
  - **I/⏪**
  - **HOME**: The home menu appears automatically (page 10, 16, 20).
  - **▶ PLAY**: Playback starts automatically.
- **System Power-Off**  
When you turn off the TV using **-TV- I/⏪** or the power button on the TV’s remote, the player and HDMI-compatible components turn off automatically.
- **Theater**  
When you press **THEATER**, the player automatically switches to the optimum video mode for watching movies. When connected with a Sony AV amplifier (receiver) using the HDMI cable, the speaker output also switches automatically. When connected with a Theater Mode-compatible TV using the HDMI cable, the TV’s video mode switches to Theater Mode. Press the button again to return to the original setting.
- **Language Follow**  
When you change the language for the on-screen display on your TV, the player’s language for the on-screen display is also changed after turning the player off and on.

### To prepare for the BRAVIA Sync features

Set “Control for HDMI” to “On” in the “System Settings” setup (page 25). For details on settings of your TV or other connected components, refer to the instruction manual supplied with the TV or components.



- When connecting the Sony TV that is compatible with the “Control for HDMI” Easy Setting function using the HDMI cable, the “Control for HDMI” setting of the player automatically switches to “On” if the “Control for HDMI” setting on the connected TV is set to “On.” Refer to the instruction manual supplied with the TV.
- When connecting the Sony TV that is compatible with the BRAVIA Sync features using the HDMI cable, you can control the basic functions of the player with the TV’s remote if the “Control for HDMI” setting on the connected TV is set to “On.” Refer to the instruction manual supplied with the TV.



Depending on the connected component, the “Control for HDMI” function may not work. Refer to the instruction manual supplied with the component.

## About wireless LAN security

Since communication via the wireless LAN function is established by radio waves, the wireless signal may be susceptible to interception. To protect wireless communication, this player supports various security functions. Be sure to correctly configure the security settings in accordance with your network environment.

### ◆ No Security

Although you can easily make settings, anyone can intercept wireless communication or intrude into your wireless network, even without any sophisticated tools. Keep in mind that there is a risk of unauthorized access or interception of data.

### ◆ WEP

WEP applies security to communications to prevent outsiders from intercepting communications or intruding into your wireless network. WEP is a legacy security technology that enables older devices, which do not support TKIP/AES, to be connected.

### ◆ WPA-PSK (TKIP), WPA2-PSK (TKIP)

TKIP is a security technology developed to correct for the deficiencies of WEP. TKIP assures a higher security level than WEP.



## ◆ WPA-PSK (AES), WPA2-PSK (AES)

AES is a security technology that uses an advanced security method that is distinct from WEP and TKIP.

AES assures a higher security level than WEP or TKIP.

## Copyrights and Trademarks

- “AVCHD” and the “AVCHD” logo are trademarks of Panasonic Corporation and Sony Corporation.
- Java and all Java-based trademarks and logos are trademarks or registered trademarks of Sun Microsystems, Inc. in the U.S. and other countries.
- “XMB,” “XMB,” and “cross media bar” are trademarks of Sony Corporation and Sony Computer Entertainment Inc.
- This product incorporates High-Definition Multimedia Interface (HDMI™) technology. HDMI, the HDMI logo and High-Definition Multimedia Interface are trademarks or registered trademarks of HDMI Licensing LLC.
- “Blu-ray Disc” is a trademark.
- “Blu-ray Disc,” “DVD+RW,” “DVD-RW,” “DVD+R,” “DVD-R,” “DVD VIDEO,” and “CD” logos are trademarks.
- “BD-LIVE,” “BD-LIVE” logo, and “BONUSVIEW” are trademarks of Blu-ray Disc Association.
- “x.v.Color” and “x.v.Color” logo are trademarks of Sony Corporation.
- “BRAVIA” is a trademark of Sony Corporation.
- “PhotoTV HD” and the “PhotoTV HD” logo are trademarks of Sony Corporation.
- MPEG Layer-3 audio coding technology and patents licensed from Fraunhofer IIS and Thomson.
- Windows Media is either a registered trademark or trademark of Microsoft Corporation in the United States and/or other countries. This product is protected by certain intellectual property rights of Microsoft Corporation. Use or distribution of such technology outside of this product is prohibited without a license from Microsoft or an authorized Microsoft subsidiary.
- This product meets ENERGY STAR® guidelines for energy efficiency. ENERGY STAR and the ENERGY STAR mark are registered U.S. marks. ENERGY STAR is a registered mark owned by the U.S. government.
- Other system and product names are generally trademarks or registered trademarks of the manufacturers. ™ and ® marks are not indicated in this document.

## Code numbers of controllable TVs

While holding down -TV- , enter the TV's manufacturer code using the number buttons.

If more than one code number is listed, try entering them one at a time until you find the one that works with your TV.

Manufacturer	Code number
Sony	01 (default)
Hitachi	02
LG/Goldstar	04
Mitsubishi/MGA	13
NEC	04
Panasonic	19
Philips	21
Pioneer	16
RCA	10
Samsung	20
Sharp	18
Toshiba	07

## Language code list

For details, see “BD/DVD Viewing Settings” (page 24).

The language spellings conform to the ISO 639: 1988 (E/F) standard.

### Code Language

1027	Afar	1186	Scots Gaelic	1349	Macedonian	1511	Albanian
1028	Abkhazian	1194	Galician	1350	Malayalam	1512	Serbian
1032	Afrikaans	1196	Guarani	1352	Mongolian	1513	Siswati; Swati
1039	Amharic	1203	Gujarati	1353	Moldavian	1514	Sesotho; Sotho
1044	Arabic	1209	Hausa	1356	Marathi		southern
1045	Assamese	1217	Hindi	1357	Malay	1515	Sundanese
1051	Aymara	1226	Croatian	1358	Malese; Maltese	1516	Swedish
1052	Azerbaijani	1229	Hungarian	1363	Burmese	1517	Swahili
1053	Bashkir	1233	Armenian	1365	Nauru	1521	Tamil
1057	Byelorussian	1235	Interlingua	1369	Nepali	1525	Telugu
1059	Bulgarian	1239	Interlingue	1376	Dutch	1527	Tajik
1060	Bihari	1245	Inupiak	1379	Norwegian	1528	Thai
1061	Bislama	1248	Indonesian	1393	Occitan	1529	Tigrinya
1066	Bengali	1253	Icelandic	1403	Oromo	1531	Turkmen
1067	Tibetan	1254	Italian	1408	Oriya	1532	Tagalog
1070	Breton	1257	Hebrew	1417	Punjabi; Panjabi	1534	Setswana; Tswana
1079	Catalan	1261	Japanese	1428	Polish	1535	Tonga;
1093	Corsican	1269	Yiddish	1435	Pashto; Pushto		Tonga islands
1097	Czech	1283	Javanese	1436	Portuguese	1538	Turkish
1103	Welsh	1287	Georgian	1463	Quechua	1539	Tsonga
1105	Danish	1297	Kazakh	1481	Rhaeto-Romance	1540	Tatar
1109	German	1298	Greenlandic;	1482	Kirundi; Rundi	1543	Twi
1130	Bhutani; Dzongkha		Kalaallisut	1483	Romanian	1557	Ukrainian
1142	Greek	1299	Cambodian; Khmer	1489	Russian	1564	Urdu
1144	English	1300	Kannada	1491	Kinyarwanda	1572	Uzbek
1145	Esperanto	1301	Korean	1495	Sanskrit	1581	Vietnamese
1149	Spanish	1305	Kashmiri	1498	Sindhi	1587	Volapük
1150	Estonian	1307	Kurdish	1501	Sangho; Sango	1613	Wolof
1151	Basque	1311	Kirghiz	1502	Serbo-Croatian	1632	Xhosa
1157	Persian	1313	Latin	1503	Singhalese;	1665	Yoruba
1165	Finnish	1326	Lingala		Sinhalese	1684	Chinese
1166	Fiji	1327	Laotian; Lao	1505	Slovak	1697	Zulu
1171	Faroese	1332	Lithuanian	1506	Slovenian	1703	not specified
1174	French	1334	Latvian	1507	Samoan		
1181	Frisian	1345	Malagasy	1508	Shona		
1183	Irish	1347	Maori	1509	Somali		

## Parental control/area code

For details, see “Parental Control Area Code” (page 24).

### Number, Area (Code)

2044, Argentina (ar)	2219, Hong Kong (hk)	2427, Pakistan (pk)
2047, Australia (au)	2248, India (in)	2424, Philippines (ph)
2046, Austria (at)	2238, Indonesia (id)	2428, Poland (pl)
2057, Belgium (be)	2239, Ireland (ie)	2436, Portugal (pt)
2070, Brazil (br)	2254, Italy (it)	2489, Russia (ru)
2090, Chile (cl)	2276, Japan (jp)	2501, Singapore (sg)
2092, China (cn)	2304, Korea (kr)	2149, Spain (es)
2093, Colombia (co)	2333, Luxembourg (lu)	2499, Sweden (se)
2115, Denmark (dk)	2363, Malaysia (my)	2086, Switzerland (ch)
2165, Finland (fi)	2362, Mexico (mx)	2543, Taiwan (tw)
2174, France (fr)	2376, Netherlands (nl)	2528, Thailand (th)
2109, Germany (de)	2390, New Zealand (nz)	2184, United Kingdom (gb)
2200, Greece (gr)	2379, Norway (no)	

---

# Index

Words in quotations appear in the on-screen displays.

## A

AUDIO 9

“Audio Settings” 23

## B

Batteries 11

“BD/DVD Viewing Settings” 24

BD-LIVE 16

BD-R 30

BD-RE 30

Bitstream 28

Blu-ray Disc 30

BONUSVIEW 16

BRAVIA Internet Video 18

BRAVIA Sync 29, 32

## C

CD 30

Child Lock 8, 29

Color buttons 9

Connecting

AV amplifier

(Receiver) 13

Network 14

TV 12

“Control for HDMI” 25, 29, 32

## D

Deep Color 22

“Dimmer” 25

DISPLAY 10

Dolby Digital 23

DTS 23

DVD 30

## E

“Easy Setup” 14, 26

## F

FAVORITES 9

## H

HDMI 22, 23

HOME 10, 20

Home menu 20

## I

Internet content 9, 18

## L

Language Follow 32

## M

MAC address 25

## N

“Network Settings” 26

“Network Update” 21

## O

One-Touch Play 32

OPTIONS 9

“OSD” 25

## P

Parental Control 24

“Parental Control Settings” 24

Play information 17

Playable discs 30

POP UP/MENU 9

## Q

“Quick Start Mode” 25

## R

Region code 31

Remote 9, 11

“Resetting” 26

Resetting the player 26

Resume 10, 29

## S

“Screen Settings” 21

“Setup” 20

Software update 21, 25

SUBTITLE 9

System Power-Off 32

“System Settings” 25

## T

THEATER 9, 32

TOP MENU 9

Troubleshooting 27

“TV Type” 21

## U

Update 21

USB 17

## W

WEP 32

WPA2-PSK (AES) 32

WPA2-PSK (TKIP) 32

WPA-PSK (AES) 32

WPA-PSK (TKIP) 32