

VANGUARD®

VENT-FREE COMPACT FIREPLACE OWNER'S OPERATION AND INSTALLATION MANUAL

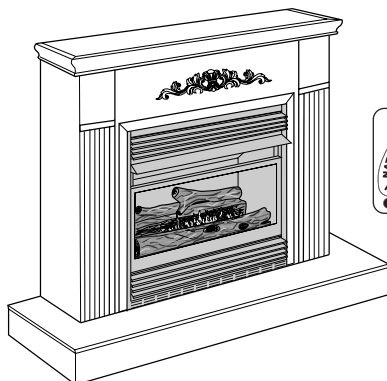

Shown with Optional Cabinet Mantel/Hearth Base Accessory

MODELS VMH26TPC AND VMH26TNC
14,000 to 26,000 Btu/Hr with Thermostat

WARNING: If the information in this manual is not followed exactly, a fire or explosion may result causing property damage, personal injury, or loss of life.

- Do not store or use gasoline or other flammable vapors and liquids in the vicinity of this or any other appliance.
- **WHAT TO DO IF YOU SMELL GAS**
 - Do not try to light any appliance.
 - Do not touch any electrical switch; do not use any phone in your building.
 - Immediately call your gas supplier from a neighbor's phone. Follow the gas supplier's instructions.
 - If you cannot reach your gas supplier, call the fire department.
- Installation and service must be performed by a qualified installer, service agency, or the gas supplier.

Save this manual for future reference.
For more information, visit www.desatech.com

WARNING: Improper installation, adjustment, alteration, service, or maintenance can cause injury or property damage. Refer to this manual for correct installation and operational procedures. For assistance or additional information consult a qualified installer, service agency, or the gas supplier.

WARNING: This is an unvented gas-fired heater. It uses air (oxygen) from the room in which it is installed. Provisions for adequate combustion and ventilation air must be provided. Refer to *Air for Combustion and Ventilation* section on page 6 of this manual.

This appliance may be installed in an aftermarket,* permanently located, manufactured (mobile) home, where not prohibited by local codes.

This appliance is only for use with the type of gas indicated on the rating plate. This appliance is not convertible for use with other gases.

* Aftermarket: Completion of sale, not for purpose of resale, from the manufacturer

TABLE OF CONTENTS

Safety Information	3	Cleaning and Maintenance	22
Local Codes	4	Troubleshooting	23
Product Identification	4	Specifications	27
Product Features	5	Service Hints	27
Unpacking	5	Technical Service	27
Assembly	5	Replacement Parts	27
Air for Combustion and Ventilation	6	Illustrated Parts Breakdown and Parts List	28
Installation	9	Accessories	30
Operating Fireplace	19	Warranty Information	Back Cover
Inspecting Burner	21		

SAFETY INFORMATION

⚠ WARNING: This product contains and/or generates chemicals known to the state of California to cause cancer or birth defects, or other reproductive harm.

IMPORTANT: Read this owner's manual carefully and completely before trying to assemble, operate, or service this fireplace. Improper use of this fireplace can cause serious injury or death from burns, fire, explosion, electrical shock, and carbon monoxide poisoning.

⚠ DANGER: Carbon monoxide poisoning may lead to death!

Carbon Monoxide Poisoning: Early signs of carbon monoxide poisoning resemble the flu, with headaches, dizziness, or nausea. If you have these signs, the fireplace may not be working properly. **Get fresh air at once!** Have fireplace serviced. Some people are more affected by carbon monoxide than others. These include pregnant women, people with heart or lung disease or anemia, those under the influence of alcohol, and those at high altitudes.

Natural and Propane/LP Gas: Natural and propane/LP gases are odorless. An odor-making agent is added to these gases. The odor helps you detect a gas leak. However, the odor added to the gas can fade. Gas may be present even though no odor exists.

Make certain you read and understand all warnings. Keep this manual for reference. It is your guide to safe and proper operation of this fireplace.

⚠ WARNING: Any change to this heater or its controls can be dangerous.

⚠ WARNING: Do not allow fans to blow directly into the fireplace. Avoid any drafts that alter burner flame patterns. Ceiling fans can create drafts that alter burner flame patterns. Altered burner patterns can cause sooting.

⚠ WARNING: Do not use a blower insert, heat exchanger insert, or other accessory not approved for use with this fireplace.

Due to high temperatures, the appliance should be located out of traffic and away from furniture and draperies.

Do not place clothing or other flammable material on or near the appliance. Never place any objects in the fireplace.

Fireplace front and screen become very hot when running fireplace. Keep children and adults away from hot surfaces to avoid burns or clothing ignition. Fireplace will remain hot for a time after shutdown. Allow surfaces to cool before touching.

Carefully supervise young children when they are in the room with fireplace.

You must operate this fireplace with the fireplace screen and hood in place. Make sure fireplace screen is in place before running fireplace.

Keep the appliance area clear and free from combustible materials, gasoline, and other flammable vapors and liquids.

1. This appliance is only for use with the type of gas indicated on the rating plate. This appliance is not convertible for use with other gases.
2. Do not place propane/LP supply tank(s) inside any structure. Locate propane/LP supply tank(s) outdoors (propane/LP only).

SAFETY INFORMATION

Continued

3. If you smell gas
 - shut off gas supply
 - do not try to light any appliance
 - do not touch any electrical switch; do not use any phone in your building
 - immediately call your gas supplier from a neighbor's phone. Follow the gas supplier's instructions
 - if you cannot reach your gas supplier, call the fire department
4. This fireplace shall not be installed in a bedroom or bathroom.
5. Do not use this fireplace as a wood-burning fireplace. Use only the logs provided with the fireplace.
6. Do not add extra logs or ornaments such as pine cones, vermiculite, or rock wool. Using these added items can cause sooting. Do not add lava rock around base. Rock and debris could fall into the control area of fireplace.
7. This fireplace is designed to be smokeless. If logs ever appear to smoke, turn off fireplace and call a qualified service person. **Note:** During initial operation, slight smoking could occur due to log curing and fireplace burning manufacturing residues.
8. To prevent the creation of soot, follow the instructions in *Cleaning and Maintenance*, page 22.
9. Before using furniture polish, wax, carpet cleaner, or similar products, turn heater off. If heated, the vapors from these products may create a white powder residue within burner box or on adjacent walls or furniture.
10. This fireplace needs fresh air ventilation to run properly. This fireplace has an Oxygen Depletion Sensing (ODS) safety shutoff system. The ODS shuts down the fireplace if not enough fresh air is available. See *Air for Combustion and Ventilation*, pages 6 through 8. If fireplace keeps shutting off, see *Troubleshooting*, pages 23 through 26.
11. Do not run fireplace
 - where flammable liquids or vapors are used or stored.
 - under dusty conditions.
12. Do not use this fireplace to cook food or burn paper or other objects.
13. Do not use fireplace if any part has been under water. Immediately call a qualified service technician to inspect the room fireplace and to replace any part of the control system and any gas control which has been under water.
14. Turn off and unplug fireplace and let cool before servicing. Only a qualified service person should service and repair fireplace.
15. Operating fireplace above elevations of 4,500 feet could cause pilot outage.
16. Do not operate fireplace if any log is broken. Do not operate fireplace if a log is chipped (dime-sized or larger).
17. To prevent performance problems, do not use propane/LP fuel tank of less than 100 lbs. capacity (propane/LP only).
18. Provide adequate clearances around air openings.

LOCAL CODES

Install and use fireplace with care. Follow all local codes. In the absence of local codes, use the latest edition of *The National Fuel Gas Code, ANSI Z223.1/NFPA 54**.

*Available from:

American National Standards Institute, Inc.

1430 Broadway

New York, NY 10018

National Fire Protection Association, Inc.

Batterymarch Park

Quincy, MA 02269

PRODUCT IDENTIFICATION

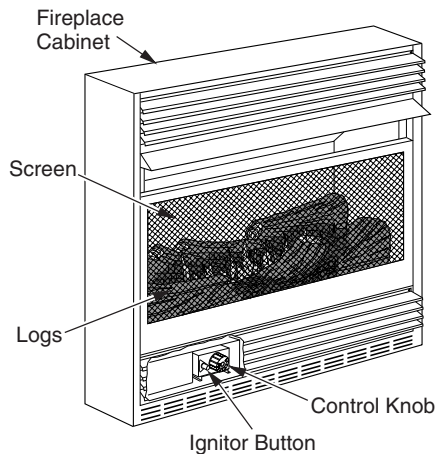

Figure 1 - Vent-Free Gas Compact Fireplace

PRODUCT FEATURES

SAFETY PILOT

This fireplace has a pilot with an Oxygen Depletion Sensing (ODS) safety shutoff system. The ODS/pilot is a required feature for vent-free room fireplaces. The ODS/pilot shuts off the fireplace if there is not enough fresh air.

PIEZO IGNITION SYSTEM

This fireplace has a piezo ignitor. This system requires no matches, batteries, or other sources to light fireplace.

THERMOSTATIC HEAT CONTROL

This fireplace has a thermostat sensing bulb and a control valve. The thermostat will automatically modulate the heat output to maintain a consistent room temperature. This results in greater fireplace comfort. This can also result in lower gas bills.

UNPACKING

1. Remove fireplace and hood from carton. Log is wrapped and inside fireplace. Do not remove at this time.
2. Remove all protective packaging applied to fireplace for shipment.
3. Make sure your fireplace includes one hardware packet.
4. Check fireplace for any shipping damage. If fireplace is damaged, promptly inform dealer where you bought fireplace.

ASSEMBLY

⚠ WARNING: Always have branch support and screen in place before operating fireplace. This prevents excessive temperatures on fireplace surfaces.

⚠ WARNING: Failure to position the parts in accordance with these diagrams or failure to use only parts specifically approved with this fireplace may result in property damage or personal injury.

ASSEMBLING FIREPLACE

Tools Required:

- Phillips screwdriver
- 5/16" hex wrench
- slotted screwdriver

Installing Log

1. Lift screen up and pull out to remove.
2. Cut two plastic straps to remove the log from the firebox cavity.
3. An optional blower is available. See *Accessories*, page 30. Install optional blower now. Follow installation instructions provided with blower.
4. Remove log packaging material and discard packaging. Gently place log set on burner support (see Figure 2). The log should fit flat against top of burner support and log locator tabs fit into the slots under the log. Do not allow log to contact flame. If flame contacts log, soot will be created.

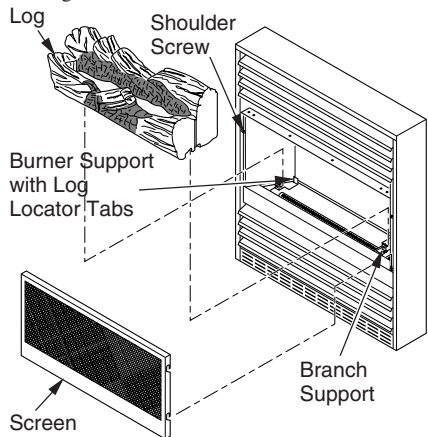

Figure 2 - Assembling Fireplace

ASSEMBLY

Continued

5. Reattach screen by placing the notches in the screen frame over the shoulder screws and pushing down.

Assembling Hood

1. Locate four black phillips sheet metal screws from the hardware packet.
2. Rotate hood as shown in Figure 3. Make sure hood tabs point toward fireplace.
3. Insert hood tabs between baffle and louvers (see Figure 3).
4. Gently rotate hood to upright position. Make sure hood tabs are behind louvers and hood is resting on firebox top (see Figure 3).
5. Align screw holes on hood with screw holes on firebox top.
6. Insert screws as shown in Figure 3. Tighten screws firmly.

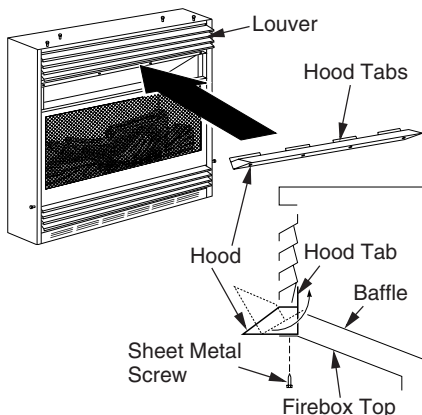

Figure 3 - Assembling Hood

AIR FOR COMBUSTION AND VENTILATION

⚠ WARNING: This heater shall not be installed in a confined space or unusually tight construction unless provisions are provided for adequate combustion and ventilation air. Read the following instructions to insure proper fresh air for this and other fuel-burning appliances in your home.

Today's homes are built more energy efficient than ever. New materials, increased insulation, and new construction methods help reduce heat loss in homes. Home owners weather strip and caulk around windows and doors to keep the cold air out and the warm air in. During heating months, home owners want their homes as airtight as possible.

While it is good to make your home energy efficient, your home needs to breathe. Fresh air must enter your home. All fuel-burning appliances need fresh air for proper combustion and ventilation.

Exhaust fans, fireplaces, clothes dryers, and fuel burning appliances draw air from the house to operate. You must provide adequate fresh air for these appliances. This will insure proper venting of vented fuel-burning appliances.

PROVIDING ADEQUATE VENTILATION

The following are excerpts from *National Fuel Gas Code, ANSI Z223.1/NFPA 54, Section 5.3, Air for Combustion and Ventilation*.

All spaces in homes fall into one of the three following ventilation classifications:

1. Unusually Tight Construction
2. Unconfined Space
3. Confined Space

The information on pages 6 through 8 will help you classify your space and provide adequate ventilation.

Unusually Tight Construction

The air that leaks around doors and windows may provide enough fresh air for combustion and ventilation. However, in buildings of unusually tight construction, you must provide additional fresh air.

AIR FOR COMBUSTION AND VENTILATION

Continued

Unusually tight construction is defined as construction where:

- walls and ceilings exposed to the outside atmosphere have a continuous water vapor retarder with a rating of one perm (6×10^{-11} kg per pa-sec- m^2) or less with openings gasketed or sealed and
- weather stripping has been added on openable windows and doors and
- caulking or sealants are applied to areas such as joints around window and door frames, between sole plates and floors, between wall-ceiling joints, between wall panels, at penetrations for plumbing, electrical, and gas lines, and at other openings.

If your home meets all of the three criteria above, you must provide additional fresh air. See *Ventilation Air From Outdoors*, page 8.

If your home does not meet all of the three criteria above, proceed to *Determining Fresh-Air Flow For Fireplace Location*.

Confined and Unconfined Space

The *National Fuel Gas Code, ANSI Z223.1.3/NFPA 54* defines a confined space as a space whose volume is less than 50 cubic feet per 1,000 Btu per hour (4.8 m^3 per kw) of the aggregate input rating of all appliances installed in that space and an unconfined space as a space whose volume is not less than 50 cubic feet per 1,000 Btu per hour (4.8 m^3 per kw) of the aggregate input rating of all appliances installed in that space. Rooms communicating directly with the space in which the appliances are installed*, through openings not furnished with doors, are considered a part of the unconfined space.

* Adjoining rooms are communicating only if there are doorless passageways or ventilation grills between them.

DETERMINING FRESH-AIR FLOW FOR FIREPLACE LOCATION

Determining if You Have a Confined or Unconfined Space

Use this work sheet to determine if you have a confined or unconfined space.

Space: Includes the room in which you will install fireplace plus any adjoining rooms with doorless passageways or ventilation grills between the rooms.

- Determine the volume of the space (length x width x height).

Length x Width x Height = _____ cu. ft. (volume of space)

Example: Space size 20 ft. (length) x 16 ft. (width) x 8 ft. (ceiling height) = 2560 cu. ft. (volume of space)

If additional ventilation to adjoining room is supplied with grills or openings, add the volume of these rooms to the total volume of the space.

- Multiply the space volume by 20 to determine the maximum Btu/Hr the space can support.

_____ (volume of space) x 20 = (Maximum Btu/Hr the space can support)

Example: 2560 cu. ft. (volume of space) x 20 = 51,200 (maximum Btu/Hr the space can support)

- Add the Btu/Hr of all fuel burning appliances in the space.

Vent-free fireplace	_____	Btu/Hr
Gas water heater*	_____	Btu/Hr
Gas furnace	_____	Btu/Hr
Vented gas heater	_____	Btu/Hr
Gas fireplace logs	_____	Btu/Hr
Other gas appliances* +	_____	Btu/Hr
Total	= _____	Btu/Hr

* Do not include direct-vent gas appliances. Direct-vent draws combustion air from the outdoors and vents to the outdoors.

Example:

Gas water heater	_____	30,000	Btu/Hr
Vent-free fireplace	+ _____	26,000	Btu/Hr
Total	= _____	56,000	Btu/Hr

- Compare the maximum Btu/Hr the space can support with the actual amount of Btu/Hr used.

_____ Btu/Hr (maximum the space can support)

_____ Btu/Hr (actual amount of Btu/Hr used)

Example: 51,200 Btu/Hr (maximum the space can support)

56,000 Btu/Hr (actual amount of Btu/Hr used)

The space in the above example is a confined space because the actual Btu/Hr used is more than the maximum Btu/Hr the space can support. You must provide additional fresh air. Your options are as follows:

AIR FOR COMBUSTION AND VENTILATION

Continued

- A. Rework worksheet, adding the space of an adjoining room. If the extra space provides an unconfined space, remove door to adjoining room or add ventilation grills between rooms. See *Ventilation Air From Inside Building*.
- B. Vent room directly to the outdoors. See *Ventilation Air From Outdoors*.
- C. Install a lower Btu/Hr fireplace, if lower Btu/Hr size makes room unconfined.

If the actual Btu/Hr used is less than the maximum Btu/Hr the space can support, the space is an unconfined space. You will need no additional fresh air ventilation.

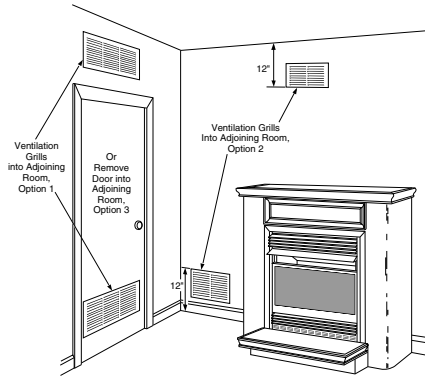

Figure 4 - Ventilation Air from Inside Building Shown with Optional Mantel

⚠ WARNING: If the area in which the heater may be operated is smaller than that defined as an unconfined space or if the building is of unusually tight construction, provide adequate combustion and ventilation air by one of the methods described in the *National Fuel Gas Code, ANSI Z223.1/NFPA 54 Section 5.3* or applicable local codes.

Ventilation Air From Outdoors

Provide extra fresh air by using ventilation grills or ducts. You must provide two permanent openings: one within 12" of the ceiling and one within 12" of the floor. Connect these items directly to the outdoors or spaces open to the outdoors. These spaces include attics and crawl spaces. Follow the *National Fuel Gas Code, ANSI Z223.1/NFPA 54, Section 5.3, Air for Combustion and Ventilation* for required size of ventilation grills or ducts.

IMPORTANT: Do not provide openings for inlet or outlet air into attic if attic has a thermostat-controlled power vent. Heated air entering the attic will activate the power vent.

VENTILATION AIR

Ventilation Air From Inside Building

This fresh air would come from an adjoining unconfined space. When ventilating to an adjoining unconfined space, you must provide two permanent openings: one within 12" of the ceiling and one within 12" of the floor on the wall connecting the two spaces (see options 1 and 2, Figure 4). You can also remove door into adjoining room (see option 3, Figure 4). Follow the *National Fuel Gas Code, ANSI Z223.1/NFPA 54, Section 5.3, Air for Combustion and Ventilation* for required size of ventilation grills or ducts.

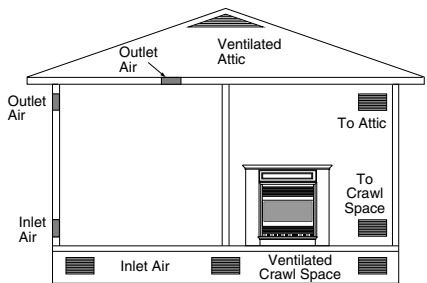

Figure 5 - Ventilation Air from Outdoors Shown with Optional Mantel

INSTALLATION

NOTICE: This heater is intended for use as supplemental heat. Use this heater along with your primary heating system. Do not install this heater as your primary heat source. If you have a central heating system, you may run system's circulating blower while using heater. This will help circulate the heat throughout the house. In the event of a power outage, you can use this heater as your primary heat source.

⚠ WARNING: A qualified service person must install fireplace. Follow all local codes.

⚠ WARNING: Never install the fireplace

- in a bedroom or a bathroom
- in a recreational vehicle
- where curtains, furniture, clothing, or other flammable objects are less than 36 inches from the front, top, or sides of the fireplace
- as a fireplace insert
- in high traffic areas
- in windy or drafty areas

⚠ CAUTION: This fireplace creates warm air currents. These currents move heat to wall surfaces next to fireplace. Installing fireplace next to vinyl or cloth wall coverings or operating fireplace where impurities (such as, but not limited to, tobacco smoke, aromatic candles, cleaning fluids, oil or kerosene lamps, etc.) in the air exist, may discolor walls or cause odors.

IMPORTANT: Vent-free fireplaces add moisture to the air. Although this is beneficial, installing fireplace in rooms without enough ventilation air may cause mildew to form from too much moisture. See *Air for Combustion and Ventilation*, pages 6 through 8.

Note: Your Vanguard fireplace is designed to be used in zero clearance installations. Wall or framing material can be placed directly against any exterior surface of your fireplace, except where standoff spacers are integrally attached. If stand-off spacers are attached to your fireplace, these spacers can be placed directly against wall or framing materials.

Use the dimensions shown for rough openings to create the easiest installation (see *Built-In Fireplace Installation*, page 10).

CHECK GAS TYPE

Use only the correct type of gas (natural or propane/LP). If your gas supply is not the correct gas type, do not install heater. Call dealer where you bought heater for proper type heater.

⚠ WARNING: This appliance is equipped for (natural or propane/LP) gas. Field conversion is not permitted.

INSTALLATION ITEMS

Before installing fireplace, make sure you have the items listed below.

- external regulator - propane/LP only (supplied by installer)
- piping (check local codes)
- sealant (resistant to propane/LP gas)
- equipment shutoff valve *
- test gauge connection*
- ground joint union
- sediment trap
- tee joint
- pipe wrench

* A CSA design-certified equipment shutoff valve with 1/8" NPT tap is an acceptable alternative to test gauge connection. Purchase the optional CSA design-certified equipment shutoff valve from your dealer. See *Accessories*, page 30.

Note: If desired, purchase a four-sided trim kit for built-in installations. See *Accessories*, page 30.

INSTALLATION

Continued

LOCATING FIREPLACE

⚠ WARNING: Maintain the minimum clearances shown in Figures 6 and 7. If you can, provide greater clearances from floor, ceiling, and joining wall.

You can recess firebox into the wall. You can also position fireplace in the optional cabinet or corner mantels. **IMPORTANT:** Only use optional cabinet or corner mantels specified in this manual. Purchase the optional mantel from your dealer (see *Accessories*, page 30).

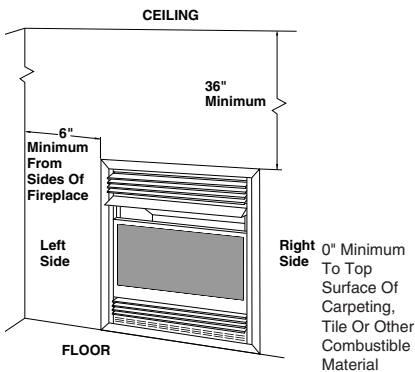

Figure 6 - Mounting Clearances As Viewed From Front of Fireplace Shown Built-In the Wall

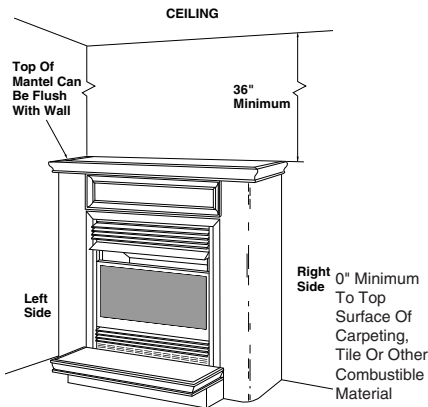

Figure 7 - Mounting Clearances As Viewed From Front of Fireplace Shown with Optional Mantel

Note: When installing fireplace directly on carpeting, tile or other combustible material, other than wood flooring, the fireplace shall be installed on a metal or wood panel extending the full width and depth of the fireplace.

⚠ CAUTION: If you install the fireplace in a home garage

- fireplace pilot and burner must be at least 18 inches above floor.
- locate fireplace where moving vehicle will not hit it.

For convenience and efficiency, install fireplace

- where there is easy access for operation, inspection, and service.
- in coldest part of room.

An optional blower kit is available from your dealer (see *Accessories*, page 30). If planning to use blower, locate fireplace near an electrical outlet.

BUILT-IN FIREPLACE INSTALLATION

Built-in installation of this fireplace involves installing fireplace into a framed-in enclosure. This makes the front of fireplace flush with wall. An optional trim kit accessory is available (see *Accessories*, page 30). Trim will extend past sides of fireplace approximately 1/2 inch. This will cover the rough edges of the wall opening. If installing a built-in mantel above the fireplace you must follow the clearances shown in Figure 11, page 12. Follow the instructions below to install the fireplace in this manner.

	Actual	Framing
Height	26"	26 ⁷ / ₈ "
Front Width	26 ³ / ₄ "	26 ⁷ / ₈ "
Depth	9 ¹ / ₂ "	10 ¹ / ₂ "
Bottom	3/4"	3/4"

1. Frame in rough opening. Use dimensions shown in Figure 8, page 11, for the rough opening.

If installing in a corner, use dimensions shown in Figure 9, page 11, for the rough opening. The height is 26 ⁷/₈" which is the same as the wall opening above.

INSTALLATION

Continued

⚠ WARNING: If pre-wiring, do not connect wiring to any electrical source at this time.

Install fireplace electrical outlet and connect wiring to outlet before connecting to electrical source. The fireplace electrical outlet is included with the GA3450T blower accessory.

Only use the fireplace electrical outlet supplied with the GA3450T blower accessory.

2. If installing GA3450T blower accessory, do so at this time. See *Installing Blower Accessory GA3450T*, page 13.

Note: If not installing blower accessory, you may wish to run electrical wiring to your fireplace for future blower installation (see *Accessories*, page 30) Use only approved three-wire electrical wiring.

Note: A qualified installer should make all electrical connections.

3. Install gas piping to fireplace location. This installation includes an approved flexible gas line (if allowed by local codes) after the equipment shutoff valve. The flexible gas line must be the last item installed on the gas piping.
4. If you have not assembled firebox, follow instructions on page 4.
5. Carefully set fireplace in front of rough opening with back of fireplace inside wall opening.
6. Attach flexible gas line to fireplace gas regulator. See *Connecting to Gas Supply*, page 16.
7. Bend four nailing flanges on outer casing with pliers (see Figure 10).
8. Attach fireplace to wall studs using nails or wood screws through holes in nailing flange.
9. Check all gas connections for leaks. See *Checking Gas Connections*, page 18.
10. If using optional trim kit, install the trim after final finishing and/or painting of wall. See instructions included with trim accessory for attaching trim.

IMPORTANT: When finishing your firebox, combustible materials

⚠ WARNING: Do not allow any combustible materials to overlap the firebox front facing.

IMPORTANT: Noncombustible materials such as brick, tile, etc. may overlap the front facing, but should never cover any necessary openings like louvered slots.

⚠ WARNING: Do not allow non-combustible materials to cover any necessary openings like louvered slots.

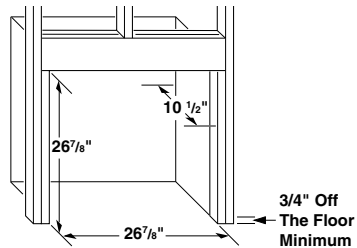

Figure 8 - Rough Opening for Installing in Wall

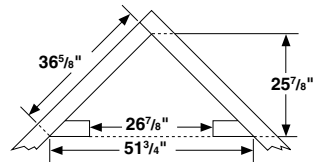

Figure 9 - Rough Opening for Installing in Corner

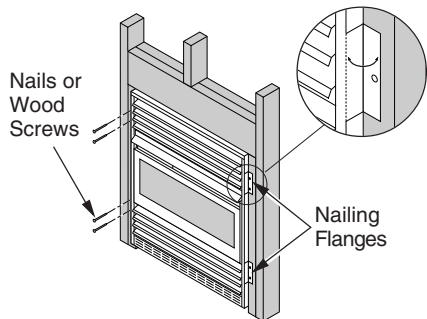

Figure 10 - Attaching Fireplace to Wall Studs

INSTALLATION

Continued

⚠ WARNING: Never modify or cover the louvered slots on the front of the firebox.

⚠ WARNING: Use only non-combustible mortar or adhesives when overlapping the front facing with noncombustible facing material.

Mantel Clearances for Built-In Installation

If placing mantel above built-in fireplace, you must meet minimum clearance between mantel shelf and top of fireplace opening.

NOTICE: Surface temperatures of adjacent walls and mantels become hot during operation. Walls and mantels above the firebox may become hot to the touch. If installed properly, these temperatures meet the requirement of the national product standard. Follow all minimum clearances shown in this manual.

NOTICE: If your installation does not meet the minimum clearances shown in Figure 11, you must do one of the following:

- raise the mantel to an acceptable height
- remove the mantel

OPTIONAL MANTEL INSTALLATION

Note: Refer to instructions provided with the mantel for assembly instructions. Refer to instructions below for system installation. Refer to instructions on page 5 for firebox assembly. Blower accessory should be installed if it is being used (see *Accessories*, page 30).

1. Unscrew four brass screws that attach top louver to fireplace. Remove louver from fireplace and set aside.
2. Place fireplace on wood base.
3. Place mantel around fireplace/base assembly.

4. Assemble trim kit. See *Assembling Perimeter Trim*, page 13.
5. Firmly snap trim kit on shoulder screws. Shoulder screws are located on fireplace cabinet (see Figure 12).
6. Align trim kit for flush fit around opening.
7. Use two 3" wood screws provided and attach fireplace base to wooden base (see Figure 12).
8. Remove trim kit and mantel. Be careful not to damage wall or mantel.
9. Place wood base next to wall at installation location.

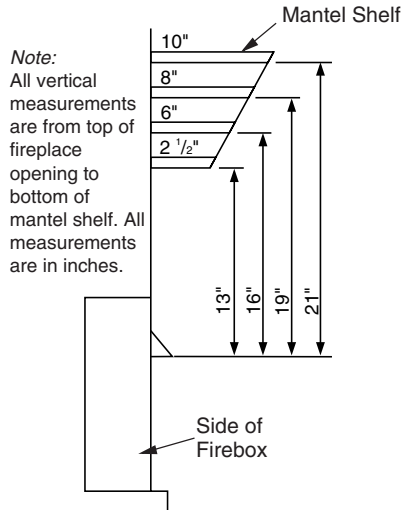

Figure 11 - Minimum Mantel Clearances for Built-In Installation

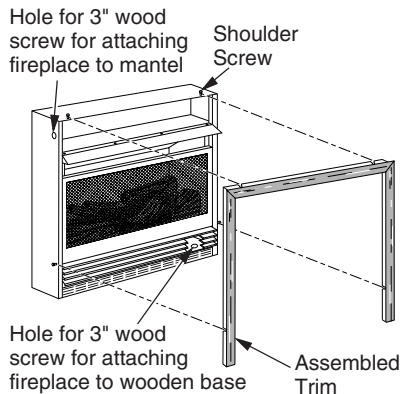

Figure 12 - Attaching Trim to Fireplace

INSTALLATION

Continued

10. Attach wood base to floor with two 1 $\frac{3}{4}$ " black screws provided (see Figure 13). If the floor is concrete use anchor method (see *Attaching Wood Base to Solid Floor*, page 16).
11. Install gas line. See *Connecting To Gas Supply*, page 16.
12. Check for leaks. See *Checking Gas Connections*, page 18.
13. Place mantel around fireplace. Be careful not to damage wall or mantel.
14. Place trim kit on the shoulder screws located on the side and top of the fireplace. Firmly snap the trim over the shoulder screws on fireplace (see Figure 12, page 12).
15. Adjust assembly to remove any gaps. Attach remaining two 3" wood screws from hardware pack through openings inside of fireplace sides into the mantel. The openings are located at top behind the area for the black louvers (see Figure 13).
16. Reinstall top black louvers.

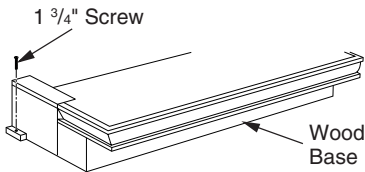

Figure 13 - Attaching Wood Base to Floor

Assembling Perimeter Trim (Trim Shipped with Mantel)

1. Remove packaging from three remaining pieces of trim.
2. Locate two adjusting plates with set screws, and two shims in the hardware packet.
3. Align shim under adjusting plate as shown in Figure 14.
4. Slide one end of adjusting plate/shim in slot on mitered edge of top trim (see Figure 14).
5. Slide other end of adjusting plate/shim in slot on mitered edge of side trim (see Figure 14).
6. While firmly holding edges of trim together, tighten both set screws on the adjusting plate with slotted screwdriver.
7. Repeat steps 1 through 6 for other corner.
8. Set trim assembly aside for later installation.

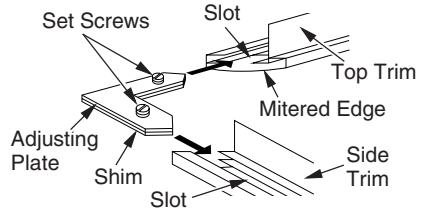

Figure 14 - Assembling Perimeter Trim

INSTALLING BLOWER ACCESSORY GA3450T

Removing Upper Louver Assembly

To install the blower accessory, you must first remove the upper louver assembly.

1. Lift screen off heater.
2. Remove 4 screws from louver assembly (see Figure 15). Save these screws.
3. Pull louver assembly straight out from the cabinet. Be careful not to scratch the paint. Set louver assembly and screws aside.

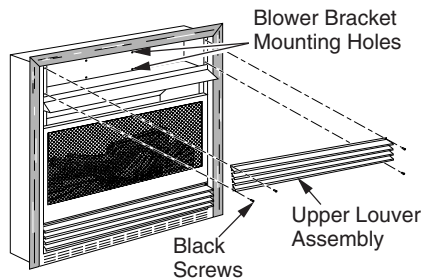

Figure 15 - Removing Upper Louver Assembly

Removing Valve Cover Shield

1. Open bottom louver assembly by swinging the assembly down (see Figure 16, page 14).
2. Using short Phillips screwdriver, remove the screw under the center of the branch support. Rotate valve cover shield clockwise and slide out.

IMPORTANT: Do not remove shoulder screw on the left side of valve cover shield. Slide the valve cover shield off of the shoulder screw (see Figure 16, page 14).

Note: If you do not have a short Phillips screwdriver, the screen, log set, and branch support must be removed so a longer screwdriver may be used. See *Connecting Equipment Shutoff Valve to Heater Control*, page 17, steps 1 and 2.

INSTALLATION

Continued

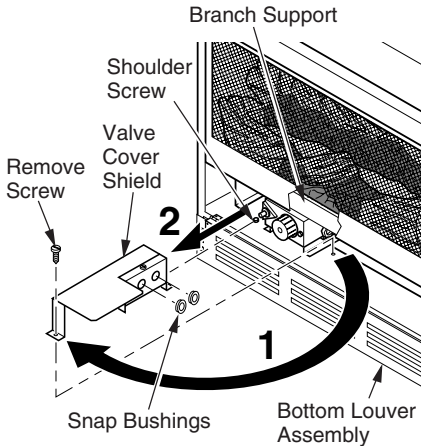

Figure 16 - Removing Valve Cover Shield

Installing Blower Assembly

CAUTION: Label all wires prior to disconnection when servicing controls. Wiring errors can cause improper and dangerous operation.

CAUTION: Verify proper operation after servicing.

Note: If you are using a mantel with your heater, use the following instructions. If your heater is built-in, see *For Built-In Installation* on page 15.

1. Install snap bushings found in hardware kit into both holes in rear of valve cover shield.
2. Make sure the wire harness is firmly connected to the terminals on the blower bracket assembly.
3. Note the wire locations on back of AUTO/OFF/ON switch. The terminals on back of switch are numbered 1, 2, and 3. Carefully remove red wire from terminal 1 and blue wire from terminal 3. Black wire can remain on middle terminal 2 (see Figure 17).
4. Carefully disconnect green and white wires at their insulated connectors.
5. In top of the heater cabinet, locate the four mounting holes on the outer casing. Align these four holes with those on the blower bracket assembly. Attach blower bracket as-

6. Route the wire harness through the hole in left side of baffle. Pull wire harness through lower opening above where the valve shield was removed. (see Figure 17).
7. Insert the 4 wire harness into one of the round holes in the rear of the valve cover shield and through the rectangular hole in the front of shield (see Figure 17).
8. Reconnect red wire to switch position 3. Reconnect blue wire to switch position 1. Reconnect green and white wires.
9. Install the switch plate on the valve cover shield with 2 #10 screws provided (see Figure 17). Reinstall the valve cover shield. Route power cord out of the cabinet by inserting it through the bushing on the outer casing (see Figure 17). Plug fan kit into 120-Volt grounded power supply and test operation.
Note: When switch is in the AUTO position, the fan will start after the heater has run for a few moments. The fan will continue to run for several moments after the heater has been turned off. When switch is in the ON position, the fan will run until turned to OFF. Reinstall upper louver assembly and hood if previously removed, (see Figure 15, page 13). Close lower louver door.

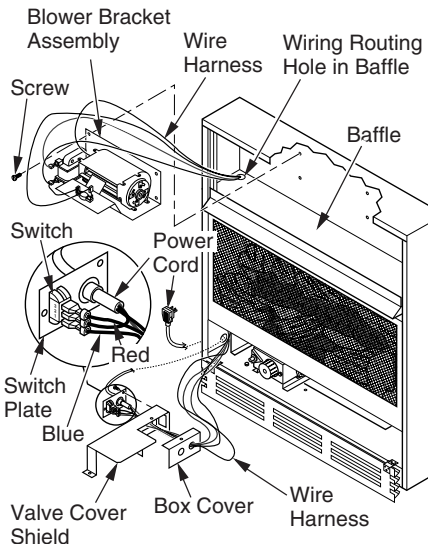

Figure 17 - Installing Blower Bracket Assembly

INSTALLATION

Continued

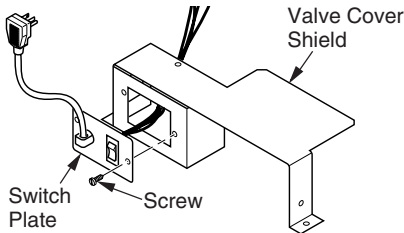

Figure 18 - Installing Switch Plate to Valve Cover Shield

For Built-In Installation

⚠ WARNING: A licensed electrician must connect the wiring harness to electrical supply following all local codes. Electrician must provide a clamp on the box cover to secure the wiring. Wiring should be routed through the bushing in the hole on the outer casing of heater.

Follow instructions *Removing Valve Cover Shield* (page 13), then

1. Install a snap bushing found in hardware kit into one of the holes found on rear of valve cover shield. The other hole is for a strain re-

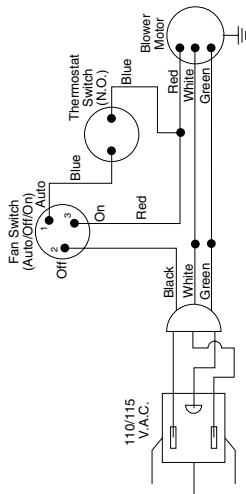

Figure 19 - Wiring Diagram For Blower Accessory Built-In Installation

2. Follow steps 2 through 6 in *Installing Blower Assembly*, page 13. Also remove black wire from middle switch terminal 2.
3. Remove black plastic strain relief and power cord from switch plate. The power cord supplied will not be used in built-in installations. Pop in the plastic snap bushing found in hardware kit into the hole left by supply cord/strain relief.
4. A licensed electrician must follow the wiring diagram to connect incoming electrical supply to fan kit wiring harness (see Figure 19).
5. Plug power cord to the outlet receptacle (not provided) as shown in Figure 18. Wind the extra power cord and tie it up with the plastic wire strap (see Figure 20). Set the power cord bundle between the burner bracket and outer casing, away from the burner.
6. Reinstall valve cover shield.
7. Test to make sure the blower is working properly.
8. Reinstall upper louver assembly and hood if previously removed, (see Figure 15, page 13). Close lower louver door.

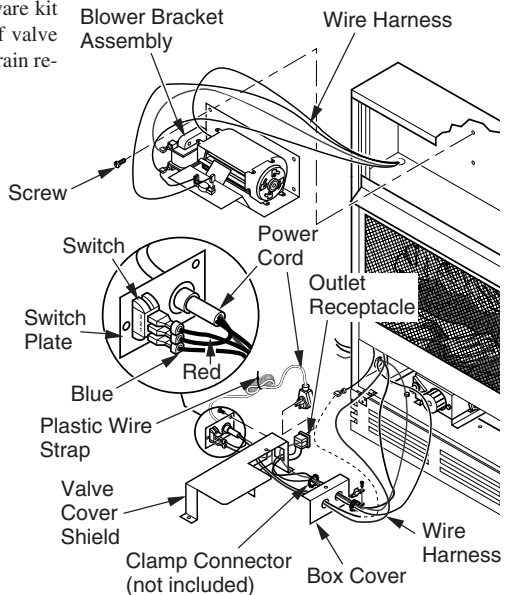

Figure 20 - Installing Blower Bracket Assembly

INSTALLATION

Continued

Extension Cord

Use extension cord if needed. The cord must have a three-prong, grounding plug and a three-hole receptacle. Make sure cord is in good shape. It must be heavy enough to carry the current needed. An undersized cord will cause a drop in line voltage. This will result in loss of power and overheating. Use a No. 16 AWG cord for lengths less than 50 feet.

ATTACHING WOOD BASE TO SOLID FLOOR

For attaching base to solid floors (concrete or masonry)

Note: Floor anchors and mounting screws are in hardware package. The hardware package is provided with fireplace.

1. Drill holes at marked locations using 5/16" drill bit. For solid floors (concrete or masonry), drill at least 1" deep.
2. Fold floor anchor as shown in Figure 21.
3. Insert floor anchor (wings first) into hole. Tap anchor flush to floor.
4. Insert mounting screws through base and into floor anchors.
5. Tighten screws until base is firmly fastened to floor.

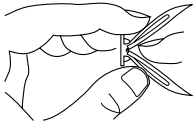

Figure 21 - Folding Anchor

CONNECTING TO GAS SUPPLY

WARNING: This appliance requires a 45° male flare fitting 5/8"-18 UNF (Unified National Fine Thread) inlet connection and the flexible gas line provided.

WARNING: A qualified service person must connect fireplace to gas supply. Follow all local codes.

CAUTION: Never connect propane/LP fireplace directly to the propane/LP supply. This fireplace requires an external regulator (not supplied). Install the external regulator between the fireplace and propane/LP supply.

WARNING: Never connect natural gas fireplace to private (non-utility) gas wells. This gas is commonly known as wellhead gas.

For propane/LP units, installer must supply an external regulator. The external regulator will reduce incoming gas pressure. You must reduce incoming gas pressure to between 11 and 14 inches of water. If you do not reduce incoming gas pressure, fireplace regulator damage could occur. Install external regulator with the vent pointing down as shown in Figure 22. Pointing the vent down protects it from freezing rain or sleet.

CAUTION: Use only new, black iron or steel pipe. Internally-tinned copper tubing may be used in certain areas. Check your local codes. Use pipe of 1/2" or greater diameter to allow proper gas volume to fireplace. If pipe is too small, undue loss of volume will occur.

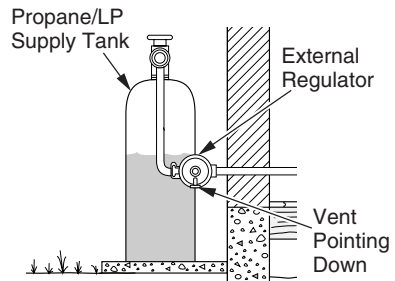

Figure 22- External Regulator with Vent Pointing Down

INSTALLATION

Continued

Installation must include a equipment shutoff valve, union, and plugged 1/8" NPT tap. Locate NPT tap within reach for test gauge hook up. NPT tap must be upstream from fireplace (see Figure 23).

IMPORTANT: Install equipment shutoff valve in an accessible location. The equipment shutoff valve is for turning on or shutting off the gas to the appliance.

Check your building codes for any special requirements for locating equipment shutoff valve to fireplaces.

Apply pipe joint sealant lightly to male NPT threads. This will prevent excess sealant from going into pipe. Excess sealant in pipe could result in clogged fireplace valves.

⚠ WARNING: Use pipe joint sealant that is resistant to liquid petroleum (LP) gas.

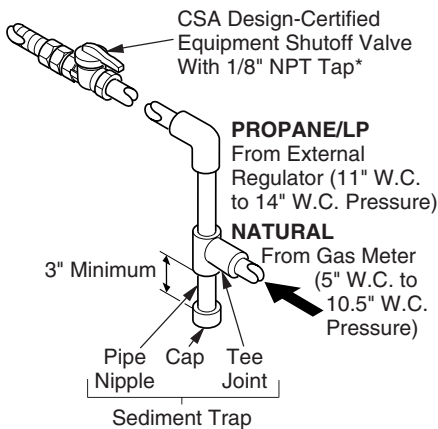

Figure 23 - Gas Connection

* Purchase the optional CSA design-certified equipment shutoff valve from your dealer. See *Accessories*, page 30.

CONNECTING EQUIPMENT SHUTOFF VALVE TO HEATER CONTROL

Installation Items Needed

- Phillips screwdriver
- sealant (resistant to propane/LP gas, not provided)

1. To remove fireplace screen, remove two screws that hold fireplace screen in place for shipping. These screws are located near top

of screen. Discard screws. Lift fireplace screen up and pull out to remove.

2. Remove screws that attach branch support to fireplace (see Figure 24). Carefully lift up branch support and remove from fireplace (see Figure 24).
3. Route flexible gas line included from fireplace control to equipment shutoff valve through side or rear access holes in outer casing.

NOTICE: Most building codes do not permit concealed gas connections. A flexible gas line is provided to allow accessibility from the fireplace (see Figure 24). The flexible gas supply line connection to the equipment shutoff valve should be accessible.

⚠ CAUTION: Avoid damage to regulator. Hold gas regulator with wrench when connecting it to gas piping and/or fittings.

4. Apply pipe joint sealant lightly to male threads of gas connector attached to flexible gas line/equipment shutoff valve (see Figure 25, page 18).
5. Check all gas connections for leaks. See *Checking Gas Connections*, page 18.
6. Replace branch support back into fireplace. Feed flexible gas line into fireplace base area while replacing branch support. Make sure the entire flexible gas line is in fireplace base area. Reattach branch support to fireplace with screws removed in step 2.

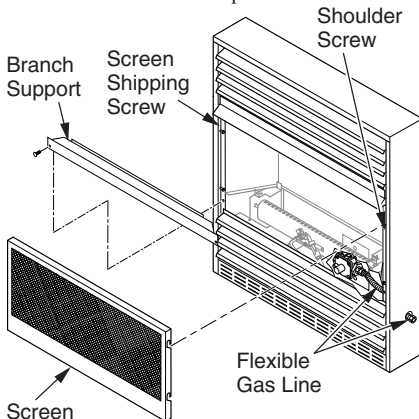

Figure 24 - Removing Log Base Assembly From Fireplace

INSTALLATION

Continued

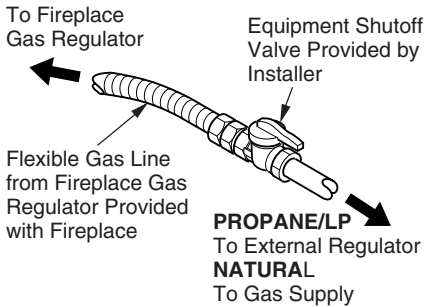

Figure 25 - Attaching Flexible Gas Line to Equipment Shutoff Valve

CHECKING GAS CONNECTIONS

WARNING: Test all gas piping and connections, internal and external to unit, for leaks after installing or servicing. Correct all leaks at once.

WARNING: Never use an open flame to check for a leak. Apply a noncorrosive leak detection fluid to all joints. Bubbles forming show a leak. Correct all leaks at once.

CAUTION: Make sure external regulator has been installed between propane/LP supply and fireplace. See guidelines under *Connecting to Gas Supply*, page 16.

Pressure Testing Gas Supply Piping System

Test Pressures In Excess Of 1/2 PSIG (3.5 kPa)

1. Disconnect appliance with its appliance main gas valve (control valve) and equipment shutoff valve from gas supply piping. Pressures in excess of 1/2 psig will damage fireplace regulator.
2. Cap off open end of gas pipe where equipment shutoff valve was connected.
3. Pressurize supply piping system by either opening propane/LP supply tank valve for propane/LP gas or opening main gas valve lo-

cated on or near gas meter for natural gas, or using compressed air.

4. Check all joints of gas supply piping system. Apply a noncorrosive leak detection fluid to gas joints. Bubbles forming show a leak.
5. Correct all leaks at once.
6. Reconnect heater and equipment shutoff valve to gas supply. Check reconnected fittings for leaks.

Test Pressures Equal To or Less Than 1/2 PSIG (3.5 kPa)

1. Close equipment shutoff valve (see Figure 26).
2. Pressurize supply piping system by either opening propane/LP supply tank valve for propane/LP gas or opening main gas valve located on or near gas meter for natural gas, or using compressed air.
3. Check all joints from gas meter for natural or propane/LP supply to equipment shutoff valve (see Figures 27 and 28, page 19). Apply a noncorrosive leak detection fluid to gas joints. Bubbles forming show a leak.
4. Correct all leaks at once.

Pressure Testing Fireplace Gas Connections

1. Open equipment shutoff valve (see Figure 26).
2. Open main gas valve located on or near gas meter for natural gas or open propane/LP supply tank valve.
3. Make sure control knob of fireplace is in the OFF position.
4. Check all joints from equipment shutoff valve to thermostat gas valve (see Figures 27 and 28, page 19). Apply a noncorrosive leak detection fluid to gas joints. Bubbles forming show a leak.
5. Correct all leaks at once.
6. Light fireplace (see *Operating Fireplace*, pages 19 and 21). Check all other internal joints for leaks.
7. Turn off fireplace (see *To Turn Off Gas to Appliance*, page 20).
8. Replace front panel.

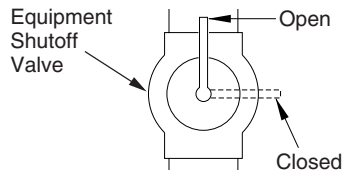

Figure 26 - Equipment Shutoff Valve

INSTALLATION

Continued

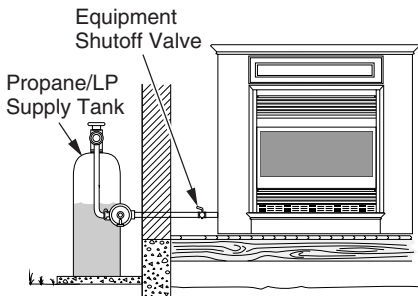

Figure 27 - Checking Gas Joints for Propane/LP Gas (Shown with Optional Mantel)

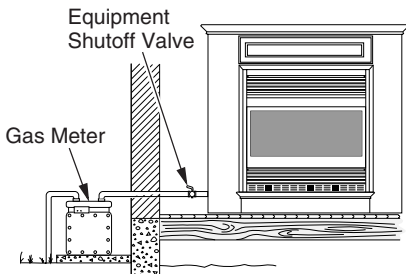

Figure 28 - Checking Gas Joints for Natural Gas (Shown with Optional Mantel)

OPERATING FIREPLACE

**FOR YOUR SAFETY
READ BEFORE LIGHTING**

WARNING: If you do not follow these instructions exactly, a fire or explosion may result causing property damage, personal injury or loss of life.

- A. This appliance has a pilot which must be lighted by hand. When lighting the pilot, follow these instructions exactly.
- B. **BEFORE LIGHTING** smell all around the appliance area for gas. Be sure to smell next to the floor because some gas is heavier than air and will settle on the floor.

WHAT TO DO IF YOU SMELL GAS

- Do not try to light any appliance.
 - Do not touch any electric switch; do not use any phone in your building.
 - Immediately call your gas supplier from a neighbor's phone. Follow the gas supplier's instructions.
 - If you cannot reach your gas supplier, call the fire department.
- C. Use only your hand to push in or turn the gas control knob. Never use tools. If the knob will not push in or turn by hand, don't try to repair it, call a qualified service technician or gas supplier. Force or attempted repair may result in a fire or explosion.
 - D. Do not use this appliance if any part has been under water. Immediately call a qualified service technician to inspect the appliance and to replace any part of the control system and any gas control which has been under water.

LIGHTING INSTRUCTIONS

WARNING: You must operate this fireplace with the fireplace screen in place. Make sure fireplace screen is installed before running fireplace.

NOTICE: During initial operation of new fireplace, burning logs will give off a paper-burning smell. Orange flame will also be present. Open window to vent smell. Operate fireplace on HI position to burn off odor. This will only last a few hours.

1. **STOP!** Read the safety information starting in column 1.
2. Make sure equipment shutoff valve is fully open.
3. Turn control knob clockwise  to the OFF position.
4. Wait five (5) minutes to clear out any gas. Then smell for gas, including near the floor. If you smell gas, **STOP!** Follow "B" in the safety information starting in column 1. If you don't smell gas, go to the next step.

OPERATING FIREPLACE

Continued

5. Turn control knob counterclockwise  to the PILOT position. Press in control knob for five (5) seconds (see Figure 29).

Note: You may be running this fireplace for the first time after hooking up to gas supply. If so, the control knob may need to be pressed in for 30 seconds or more. This will allow air to bleed from the gas system.

- If control knob does not pop up when released, contact a qualified service person or gas supplier for repairs.

6. With control knob pressed in, push down and release ignitor button. This will light pilot. The pilot is attached to the front of burner. If needed, keep pressing ignitor button until pilot lights.

Note: If pilot does not stay lit, refer to *Troubleshooting*, pages 23 through 26. Also contact a qualified service person or gas supplier for repairs. Until repairs are made, light pilot with match. To light pilot with match, see *Manual Lighting Procedure*.

7. Keep control knob pressed in for 30 seconds after lighting pilot. After 30 seconds, release control knob.

Note: If pilot goes out, repeat steps 3 through 7. This fireplace has a safety interlock system. Wait one (1) minute before lighting pilot again.

8. Turn control knob counterclockwise  to desired heating level. The main burner should light. Set control knob to any heat level between HI and LO.

CAUTION: Do not try to adjust heating levels by using the equipment shutoff valve.

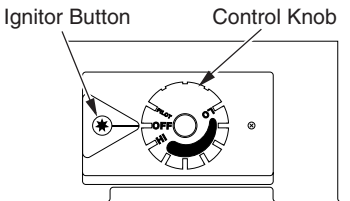

Figure 29 - Control Knob In The OFF Position

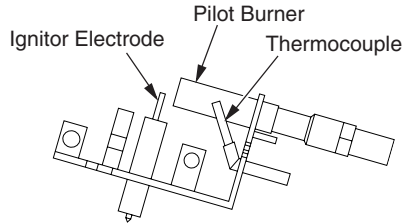



Figure 30 - Pilot (Propane/LP Shown)

TO TURN OFF GAS TO APPLIANCE

Shutting Off Fireplace

1. Turn control knob clockwise  to the OFF position.
2. Turn off all electric power to the appliance if service is to be performed.

Shutting Off Burner Only (pilot stays lit)

Turn control knob clockwise  to the PILOT position.

THERMOSTAT CONTROL OPERATION

The thermostatic control used on this fireplace differs from standard thermostats. Standard thermostats simply turn on and off the burner. The thermostat used on this fireplace senses the room temperature. The thermostat adjusts the amount of gas flow to the burner. This increases or decreases the burner flame height. At times the room may exceed the set temperature. If so, the burner will shut off. The burner will cycle back on when room temperature drops below the set temperature.

The control knob can be set to any heat level between HI and LO.

Note: The thermostat sensing bulb measures the temperature of air near the fireplace cabinet. This may not always agree with room temperature (depending on housing construction, installation location, room size, open air temperatures, etc.). Frequent use of your fireplace will let you determine your own comfort levels.

MANUAL LIGHTING PROCEDURE

1. Follow steps 1 through 5 under *Lighting Instructions*, starting on page 19, column 1.
2. With control knob pressed in, strike match. Hold match to pilot until pilot lights.
3. Keep control knob pressed in for 30 seconds after lighting pilot. After 30 seconds, release control knob. Now follow step 8 under *Lighting Instructions*, column 1

OPERATING FIREPLACE

Continued

OPERATING BLOWER

This blower has three settings: ON, OFF, and AUTO. In the ON position, the blower will operate constantly. In the OFF position, the blower will not operate. In the AUTO position, the blower will start when the thermostat senses a sufficient increase in firebox temperature.

Note: Your fireplace and thermostat blower will not turn on and off at the same time. The fireplace may run for several minutes before the blower turns on. After the heater modulates to the pilot position, the blower will continue to run. The blower will shut off after the firebox temperature decreases.

Note: It is safe to operate fireplace with blower turned off. However, the blower helps distribute heated air from the fireplace.

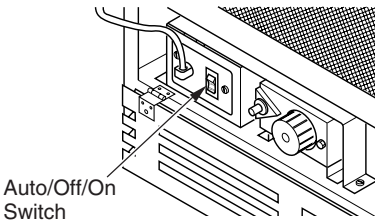

Figure 31 - Auto/Off/On Switch

INSPECTING BURNER

Check pilot flame pattern and burner flame pattern often.

PILOT FLAME PATTERN

Figure 32 shows a correct pilot flame pattern. Figure 33 shows an incorrect pilot flame pattern. The incorrect pilot flame is not properly heating the thermocouple. This will cause the thermocouple to cool. When the thermocouple cools, the fireplace will shut down.

If pilot flame pattern is incorrect, as shown in Figure 33

- turn fireplace off (see *To Turn Off Gas to Appliance*, page 20)
- see *Troubleshooting*, pages 23 through 26

Note: The pilot flame on natural gas units will have a slight curve, but flame should be blue and have no yellow or orange color.

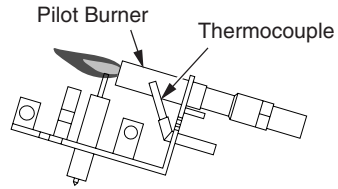

Figure 32 - Correct Pilot Flame Pattern (Propane/LP Shown)

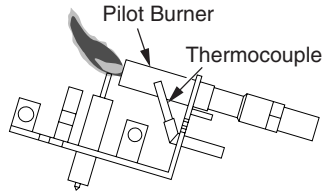

Figure 33 - Incorrect Pilot Flame Pattern (Propane/LP Shown)

BURNER FLAME PATTERN

Figure 34 shows a correct burner flame pattern. Figure 35 shows an incorrect burner flame pattern. The incorrect burner flame pattern shows sporadic, irregular flame tipping. The flame should not be dark or have an orange/reddish tinge.

Note: When using the fireplace the first time, the flame will be orange for approximately one hour until the log cures.

If burner flame pattern is incorrect, as shown in Figure 35

- turn fireplace off (see *To Turn Off Gas to Appliance*, page 20)
- see *Troubleshooting*, pages 23 through 26

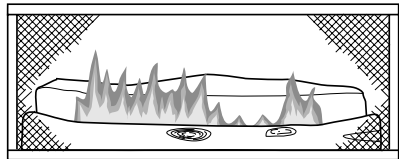

Figure 34 - Correct Burner Flame Pattern

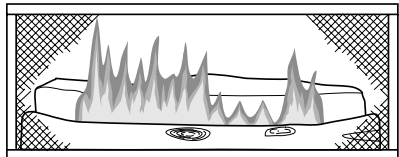

Figure 35 - Incorrect Burner Flame Pattern

CLEANING AND MAINTENANCE

WARNING: Turn off fireplace and let cool before cleaning.

CAUTION: You must keep control areas, burner, and circulating air passageways of fireplace clean. Inspect these areas of fireplace before each use. Have fireplace inspected yearly by a qualified service person. Fireplace may need more frequent cleaning due to excessive lint from carpeting, bedding material, pet hair, etc.

WARNING: Failure to keep the primary air opening(s) of the burner(s) clean may result in sooting and property damage.

BURNER INJECTOR HOLDER AND PILOT AIR INLET HOLE

The primary air inlet holes allow the proper amount of air to mix with the gas. This provides a clean burning flame. Keep these holes clear of dust, dirt, lint, and pet hair. Clean these air inlet holes prior to each heating season. Blocked air holes will create soot. We recommend that you clean the unit every three months during operation and have heater inspected yearly by a qualified service person.

We also recommend that you keep the burner tube and pilot assembly clean and free of dust and dirt. To clean these parts we recommend using compressed air no greater than 30 PSI. Your local computer store, hardware store, or home center may carry compressed air in a can. You can use a vacuum cleaner in the blow position. If using compressed air in a can, please follow the directions on the can. If you don't follow directions on the can, you could damage the pilot assembly.

1. Shut off the unit, including the pilot. Allow the unit to cool for at least thirty minutes.
2. Inspect burner, pilot, and primary air inlet holes on injector holder for dust and dirt (see Figure 36).
3. Blow air through the ports/slots and holes in the burner.

4. Check the injector holder located at the end of the burner tube again. Remove any large particles of dust, dirt, lint, or pet hair with a soft cloth or vacuum cleaner nozzle.
5. Blow air into the primary air holes on the injector holder.
6. In case any large clumps of dust have now been pushed into the burner repeat steps 3 and 4.

Clean the pilot assembly also. A yellow tip on the pilot flame indicates dust and dirt in the pilot assembly. There is a small pilot air inlet hole about two inches from where the pilot flame comes out of the pilot assembly (see Figure 37). With the unit off, lightly blow air through the air inlet hole. You may blow through a drinking straw if compressed air is not available.

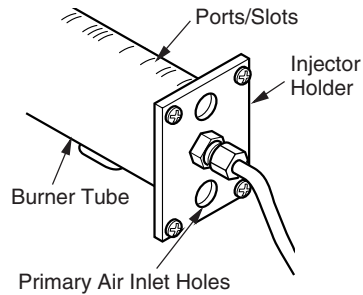

Figure 36 - Injector Holder On Outlet Burner Tube

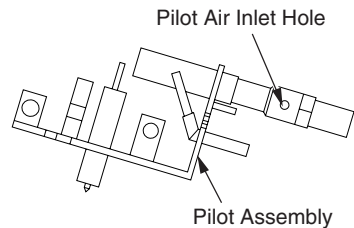

Figure 37 - Pilot Inlet Air Hole (Propane/LP Shown)

CABINET

Air Passageways

- Use a vacuum cleaner or pressurized air to clean.

Exterior

- Use a soft cloth dampened with a mild soap and water mixture. Wipe the cabinet to remove dust.

TROUBLESHOOTING

Note: All troubleshooting items are listed in order of operation.



WARNING: Turn off heater and let cool before servicing. Only a qualified service person should service and repair heater.



CAUTION: Never use a wire, needle, or similar object to clean ODS/pilot. This can damage ODS/pilot unit.

OBSERVED PROBLEM	POSSIBLE CAUSE	REMEDY
When ignitor button is pressed, there is no spark at ODS/pilot	1. Ignitor cable pinched or wet	1. Free ignitor cable if pinched by any metal or tubing. Keep ignitor cable dry
	2. Ignitor electrode not connected to ignitor cable	2. Reconnect ignitor cable
	3. Broken ignitor cable	3. Replace ignitor cable
	4. Bad piezo ignitor	4. Replace piezo ignitor
	5. Ignitor electrode broken	5. Replace pilot assembly
	6. Ignitor electrode positioned wrong	6. Replace pilot assembly
When ignitor button is pressed, there is spark at ODS/pilot but no ignition	1. Gas supply turned off or equipment shutoff valve closed	1. Turn on gas supply or open equipment shutoff valve
	2. Control knob not in PILOT position	2. Turn control knob to PILOT position
	3. Control knob not pressed in while in PILOT position	3. Press in control knob while in PILOT position
	4. Air in gas lines when installed	4. Continue holding down control knob. Repeat igniting operation until air is removed
	5. Depleted gas supply (propane/LP only)	5. Contact local propane/LP gas company
	6. ODS/pilot is clogged	6. Clean ODS/pilot (see <i>Cleaning and Maintenance</i> , page 22) or replace ODS/pilot assembly
	7. Gas regulator setting is not correct	7. Replace gas regulator

TROUBLESHOOTING

Continued

OBSERVED PROBLEM	POSSIBLE CAUSE	REMEDY
ODS/pilot lights but flame goes out when control knob is released	1. Control knob not fully pressed in	1. Press in control knob fully
	2. Control knob not pressed in long enough	2. After ODS/pilot lights, keep control knob pressed in 30 seconds
	3. Safety interlock system has been triggered	3. Wait one minute for safety interlock system to reset. Repeat ignition operation
	4. Equipment shutoff valve not fully open	4. Fully open equipment shutoff valve
	5. Thermocouple connection loose at control valve	5. Hand tighten until snug, then tighten 1/4 turn more
	6. Pilot flame not touching thermocouple, which allows thermocouple to cool, causing pilot flame to go out. This problem could be caused by one or both of the following: A) Low gas pressure B) Dirty or partially clogged ODS/pilot	6. A) Contact local propane/LP or natural gas company B) Clean ODS/pilot (see <i>Cleaning and Maintenance</i> , page 22) or replace ODS/pilot assembly
	7. Thermocouple damaged	7. Replace pilot assembly
	8. Control valve damaged	8. Replace control valve
Burner does not light after ODS/pilot is lit	1. Burner orifice is clogged	1. Clean burner (see <i>Cleaning and Maintenance</i> , page 22) or replace burner orifice
	2. Inlet gas pressure is too low	2. Contact local propane/LP or natural gas company
Delayed ignition of burner	1. Manifold pressure is too low	1. Contact local propane/LP or natural gas company
	2. Burner orifice is clogged	2. Clean burner (see <i>Cleaning and Maintenance</i> , page 22) or replace burner orifice
Burner backfiring during combustion	1. Burner orifice is clogged or damaged	1. Clean burner (see <i>Cleaning and Maintenance</i> , page 22) or replace burner orifice
	2. Burner damaged	2. Replace burner pressure
	3. Low inlet gas pressure	3. Contact local propane/LP or natural gas company
	4. Gas regulator defective	4. Replace gas regulator
Yellow flame during burner combustion	1. Not enough air	1. Check burner for dirt and debris. If found, clean burner (see <i>Cleaning and Maintenance</i> , page 22)
	2. Gas regulator defective	2. Replace gas regulator

TROUBLESHOOTING

Continued

OBSERVED PROBLEM	POSSIBLE CAUSE	REMEDY
Slight smoke or odor during initial operation	1. Residues from manufacturing processes	1. Problem will stop after a few hours of operation
Fireplace produces a whistling noise when burner is lit	1. Turning control knob to HI position when burner is cold 2. Air in gas line 3. Air passageways on fireplace blocked 4. Dirty or partially clogged burner orifice	1. Turn control knob to LO position and let warm up for a minute 2. Operate burner until air is removed from line. Have gas line checked by local propane/LP gas company 3. Observe minimum installation clearances (see pages 9 through 12) 4. Clean burner (see <i>Cleaning and Maintenance</i> , page 22) or replace burner orifice
White powder residue forming within burner box or on adjacent walls or furniture	1. When heated, vapors from furniture polish, wax, carpet cleaners, etc. may turn into white powder residue	1. Turn heater off when using furniture polish, wax, carpet cleaners, or similar products
Fireplace produces a clicking/ticking noise just after burner is lit or shut off	1. Metal expanding while heating or contracting while cooling	1. This is common with most fireplaces. If noise is excessive, contact qualified service person

TROUBLESHOOTING

Continued



WARNING: If you smell gas

- Shut off gas supply.
- Do not try to light any appliance.
- Do not touch any electrical switch; do not use any phone in your building.
- Immediately call your gas supplier from a neighbor's phone. Follow the gas supplier's instructions.
- If you cannot reach your gas supplier, call the fire department.

IMPORTANT: Operating fireplace where impurities in air exist may create odors. Cleaning supplies, paint, paint remover, cigarette smoke, cements and glues, new carpet or textiles, etc., create fumes. These fumes may mix with combustion air and create odors.

OBSERVED PROBLEM	POSSIBLE CAUSE	REMEDY
Fireplace produces unwanted odors	<ol style="list-style-type: none">1. Fireplace burning vapors from paint, hair spray, glues, etc. (See <i>IMPORTANT</i> statement above)2. Low fuel supply (propane/LP)3. Gas leak. See Warning statement above	<ol style="list-style-type: none">1. Ventilate room. Stop using odor causing products while fireplace is running2. Refill supply tank3. Locate and correct all leaks (see <i>Checking Gas Connections</i>, page 18)
Fireplace shuts off in use (ODS operates)	<ol style="list-style-type: none">1. Not enough fresh air is available2. Low line pressure3. ODS/pilot is partially clogged	<ol style="list-style-type: none">1. Open window and/or door for ventilation2. Contact local propane/LP or natural gas company3. Clean ODS/pilot (see <i>Cleaning and Maintenance</i>, page 22)
Gas odor even when control knob is in OFF position	<ol style="list-style-type: none">1. Gas leak. See Warning statement above2. Control valve defective	<ol style="list-style-type: none">1. Locate and correct all leaks (see <i>Checking Gas Connections</i>, page 18)2. Replace control valve
Gas odor during combustion	<ol style="list-style-type: none">1. Foreign matter between control valve and burner2. Gas leak. See Warning statement above	<ol style="list-style-type: none">1. Take apart gas tubing and remove foreign matter2. Locate and correct all leaks (see <i>Checking Gas Connections</i>, page 18)
Moisture/condensation noticed on windows	<ol style="list-style-type: none">1. Not enough combustion/ventilation air	<ol style="list-style-type: none">1. Refer to <i>Air for Combustion and Ventilation</i> requirements (page 6)

SPECIFICATIONS

	VMH26TPC	VMH26TNC
Btu (Variable)	14,000/26,000	14,000/26,000
Type Gas	Propane/LP Only	Natural Only
Ignition	Piezo	Piezo
Pressure Regulator Setting	8" W.C.	3" W.C.
Inlet Gas Pressure (in. of water) *		
Maximum	14"	10.5"
Minimum	11"	5"
Dimensions, Inches (H x W x D)		
Fireplace (including hood and screws)	25 ⁷ / ₈ x 26 ¹³ / ₁₆ x 9 ³ / ₈	25 ⁷ / ₈ x 26 ¹³ / ₁₆ x 9 ³ / ₈
Carton	32 ⁵ / ₈ x 27 ³ / ₁₆ x 11 ⁵ / ₈	32 ⁵ / ₈ x 27 ³ / ₁₆ x 11 ⁵ / ₈
Weight, pounds		
Fireplace	44.5 lbs.	44.5 lbs.
Shipping	48 lbs.	48 lbs.

* For purposes of input adjustment

SERVICE HINTS

When Gas Pressure Is Too Low

- pilot will not stay lit
- burner will have delayed ignition
- fireplace will not produce specified heat
- propane/LP gas supply may be low (propane/LP only)

You may feel your gas pressure is too low. If so, contact your local propane/LP or natural gas supplier.

TECHNICAL SERVICE

You may have further questions about installation, operation, or troubleshooting. If so, contact DESA Heating Products' Technical Service Department at 1-866-672-6040. When calling, please have your model and serial numbers of your heater ready.

You can also visit DESA Heating Products' technical services web site at www.desatech.com.

REPLACEMENT PARTS

Note: Use only original replacement parts. This will protect your warranty coverage for parts replaced under warranty.

PARTS UNDER WARRANTY

Contact authorized dealers of this product. If they can't supply original replacement part(s) call DESA Heating Products' Technical Service Department at 1-866-672-6040 for referral information.

When calling DESA Heating Products, have ready

- your name
- your address
- model and serial numbers of your fireplace
- how fireplace was malfunctioning
- type of gas used (propane/LP or natural gas)
- purchase date

Usually, we will ask you to return the part to the factory.

PARTS NOT UNDER WARRANTY

Contact authorized dealers of this product. If they can't supply original replacement part(s) call DESA Heating Products at 1-866-672-6040 for referral information.

When calling DESA, have ready

- model number of your fireplace
- the replacement part number

ILLUSTRATED PARTS BREAKDOWN

MODELS VMH26TPC (Shown) AND VMH26TNC

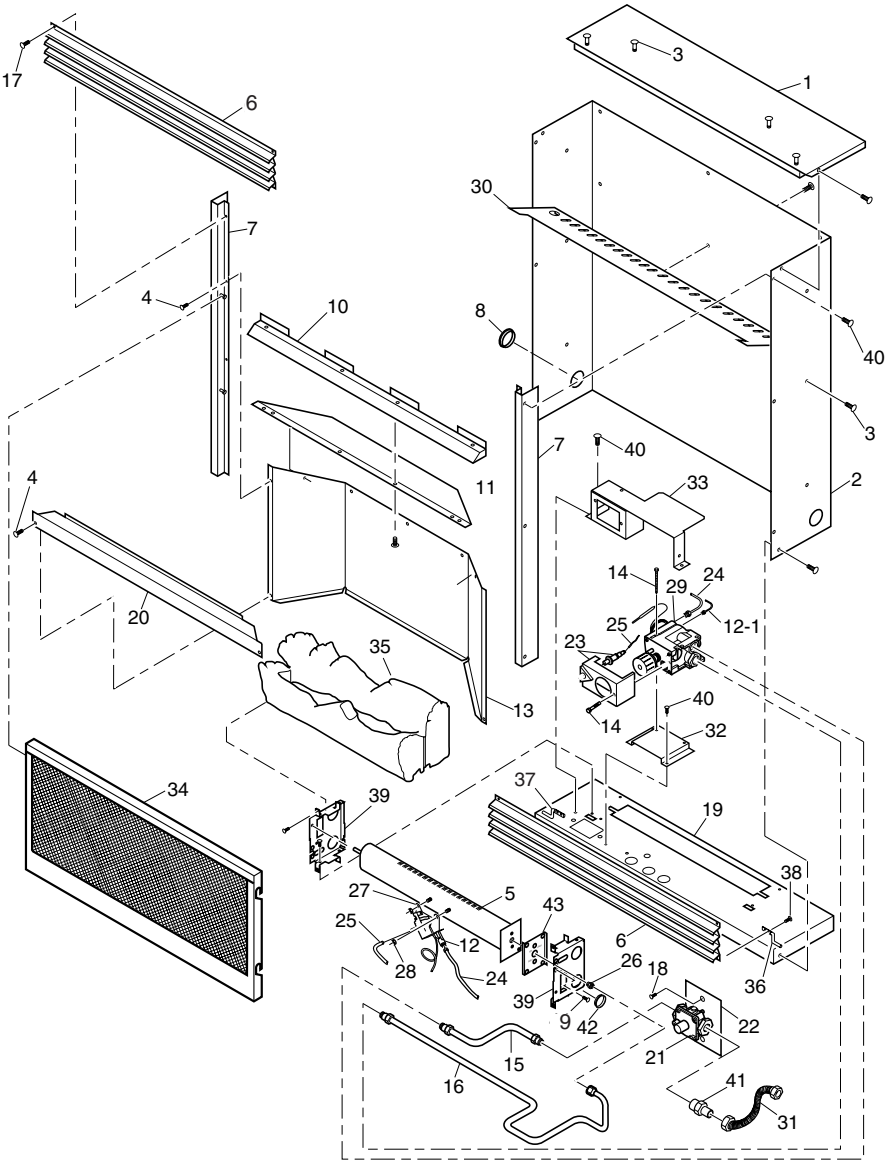

PARTS LIST

This list contains replaceable parts used in your fireplace. When ordering parts, follow the instructions listed under *Replacement Parts* on page 27 of this manual.

KEY NO.	PART NUMBER		DESCRIPTION	QTY.
	VMH26TPC	VMH26TNC		
1	102633-02	102633-02	Outer Casing Top	1
2	102624-02	102624-02	Outer Casing	1
3	099230-02	099230-02	Shoulder Screw	14
4	098304-01	098304-01	Screw, #10 x 3/8"	15
5	109824-05	109824-05	Burner	1
6	103209-05	103209-05	Louvered Door	2
7	102635-02	102635-02	Left and Right Side Front	2
8	101629-02	101629-02	Bushing	1
9	M10908-75	M10908-75	Hex Washer Head Tapping Screw	1
10	104281-02BR	104281-02BR	Firebox Hood	1
11	102638-01	102638-01	Firebox Top	1
12	104286-01	104285-01	ODS/Pilot Assembly	1
13	**	**	Firebox Wrapper	1
14	099211-01	099211-01	Control Bracket Screw	2
15	103963-01	103963-01	Inlet Tube	1
16	102834-01	102834-01	Burner Tube	1
17	098304-02	098304-02	Black Screw, #6 x 3/8	4
18	098303-02	098303-02	Regulator Screw	2
19	**	**	Outer Shell Base	1
20	102649-02	102649-02	Branch Support	1
21	099415-09	099415-10	Gas Regulator	1
22	102875-01	102875-01	Regulator Bracket	1
23	101381-01	101381-01	Valve Cover and Piezo	1
24	099387-11	099387-11	Pilot Tube	1
25	098271-06	098271-06	Ignitor Cable	1
26	107186-01	107186-02	Injector	1
27	101006-02	101006-02	Pilot Bracket	1
28	098249-01	098249-01	Nut, M5	2
29	098522-26	098522-23	Gas Valve	1
30	102639-01	102639-01	Baffle	1
31	101628-01	101628-01	Flexible Connector	1
32	102869-01	102869-01	Control Bracket	1
33	102731-01	102731-01	Control Shield	1
34	103295-05BR	103295-05BR	Screen Assembly	1
35	107153-01	107153-01	Log Set Kit	1
36	104313-01	104313-01	Right Hinge	1
37	104313-02	104313-02	Left Hinge	1
38	M10908-2	M10908-2	Hinge Screws	4
39	103734-01	103734-01	Burner Support	2
40	M11084-26	M11084-26	Hex Head Screw, #10 x 3/8"	28
41	097809-03	097809-03	3/8 NPT x 3/8" Flare Brass Fitting	1
42	101629-01	101629-01	Bushing	1
43	—	107634-02	NG Conversion Plate	1
PARTS AVAILABLE — NOT SHOWN				
	101054-01	101054-01	Lighting Instructions Plate	1
	100563-01	100563-01	Warning Plate	1
	103470-01	103470-01	Hardware Package	1

** Part not available for field replacement.

ACCESSORIES

NOTICE: All accessories may not be available for all fireplace models.

Purchase these fireplace accessories from your local dealer. If they cannot supply these accessories call DESA Heating Products' Sales Department at 1-866-672-6040 for referral information. You can also write to the address listed on the back page of this manual.

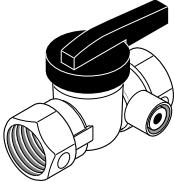

EQUIPMENT SHUTOFF VALVE GA5010

For all models. Equipment shutoff valve with 1/8" NPT tap.

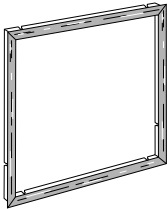

PERIMETER TRIM KIT - GA6094

For all models. Optional three-sided perimeter trim kit for custom and recessed installations (when unit is on the floor). Provides a finished appearance by covering rough edges of wall opening. Included with all mantels.

PERIMETER TRIM KIT - GA6095

GA6094 - Polished Brass
GAB6094 - Black
GAP6094 - Platinum

For all models. Optional three-sided perimeter trim kit for custom and recessed installations (when unit is on the floor). Provides a finished appearance by covering rough edges of wall opening. Black trim included with all mantels.

EXTRUDED LOUVER KIT

(Not Shown)
GA9092 - Polished Brass
GAP9092 - Platinum

For all models. Optional extruded louver. Kit contains 2 louvers.

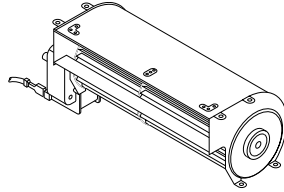

THERMOSTATICALLY - CONTROLLED BLOWER KIT GA3450TA

For all models. Provides better heat distribution. Makes fireplace more efficient. Automatically turns off and on as needed.

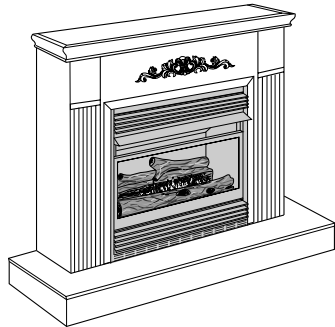

CABINET MANTEL WITH FULL HEARTH BASE AND ROUNDED LEG STYLING

Unfinished - GMC61U
Oak Finished - GMC60F

(Appearance May Differ by Model)

For all models. A mantel and hearth base offers compact styling and completes the fireplace look. Available in an oak stain finish, or an unfinished birch, ready to stain or paint. Complete assembly instructions included. Three-sided perimeter trim kit included.

ACCESSORIES

Continued

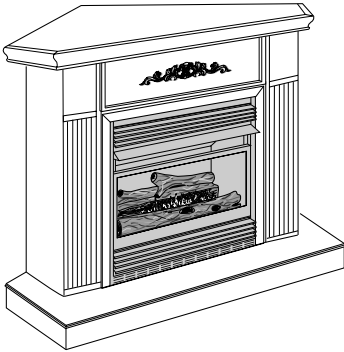

CORNER MANTEL WITH FULL HEARTH BASE

Unfinished - GMC63U

Finished - GMC64F

For all models. Space-saving mantel and hearth base corner design features clean, classic lines. Available in a stained oak finish, white lacquer finish, or an unfinished birch, ready to stain or paint. Complete assembly instructions included. Three-sided perimeter trim kit included.

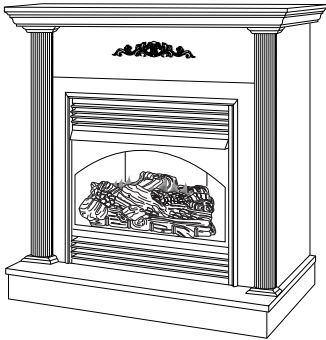

CABINET MANTEL AND FULL HEARTH BASE

GMC80F Series - Oak Finished

GMC81U Series - Unfinished Birch

GMC82F Series - Cherry Finished Birch

For all models. Mantel features columns, moldings, fluting and medallion. Three-sided perimeter trim kit included.

Dimensions (WxHxD): 56" x 50" x 24"

CLEANING KIT - GCK

(Not Shown)

Your vent-free gas appliance requires regular cleaning and maintenance to prevent performance problems. This kit gives you the tools and instructions to make it easy to clean all critical areas of your appliance.

INFORMATION VIDEO - 108917-01

A care and maintenance video is available by calling 1-866-672-6040. You may also email your request to productsupport@desaint.com.

FIRE CRACKLE - CF6-A

(Not Shown)

Creates the sound of a real burning fire.

WARRANTY INFORMATION

KEEP THIS WARRANTY

Model _____
Serial No. _____
Date Purchased _____

Always specify model and serial numbers when communicating with the factory.

We reserve the right to amend these specifications at any time without notice. The only warranty applicable is our standard written warranty. We make no other warranty, expressed or implied.

LIMITED WARRANTY VENT-FREE COMPACT CLASSIC HEARTH® FIREPLACE

DESA Heating Products warrants this product to be free from defects in materials and components for four (4) years and five (5) years on stainless steel burners from the date of first purchase, provided that the product has been properly installed, operated and maintained in accordance with all applicable instructions. To make a claim under this warranty the Bill of Sale or cancelled check must be presented.

This warranty is extended only to the original retail purchaser. This warranty covers the cost of part(s) required to restore this fireplace to proper operating condition and an allowance for labor when provided by a DESA Heating Products Authorized Service Center. Warranty part(s) MUST be obtained through authorized dealers of this product and/or DESA Heating Products who will provide original factory replacement parts. Failure to use original factory replacement parts voids this warranty. The fireplace MUST be installed by a qualified installer in accordance with all local codes and instructions furnished with the unit.

This warranty does not apply to parts that are not in original condition because of normal wear and tear, or parts that fail or become damaged as a result of misuse, accidents, lack of proper maintenance or defects caused by improper installation. Travel, diagnostic cost, labor, transportation and any and all such other costs related to repairing a defective fireplace will be the responsibility of the owner.

TO THE FULL EXTENT ALLOWED BY THE LAW OF THE JURISDICTION THAT GOVERNS THE SALE OF THE PRODUCT; THIS EXPRESS WARRANTY EXCLUDES ANY AND ALL OTHER EXPRESSED WARRANTIES AND LIMITS THE DURATION OF ANY AND ALL IMPLIED WARRANTIES, INCLUDING WARRANTIES OF MERCHANTABILITY AND FITNESS FOR A PARTICULAR PURPOSE TO FOUR (4) YEARS ON ALL COMPONENTS AND FIVE (5) YEARS ON STAINLESS STEEL BURNERS FROM THE DATE OF FIRST PURCHASE; AND DESA HEATING PRODUCTS' LIABILITY IS HEREBY LIMITED TO THE PURCHASE PRICE OF THE PRODUCT AND DESA HEATING PRODUCTS SHALL NOT BE LIABLE FOR ANY OTHER DAMAGES WHATSOEVER INCLUDING INDIRECT, INCIDENTAL OR CONSEQUENTIAL DAMAGES.

Some states do not allow a limitation on how long an implied warranty lasts or an exclusion or limitation of incidental or consequential damages, so the above limitation on implied warranties, or exclusion or limitation on damages may not apply to you.

This warranty gives you specific legal rights, and you may also have other rights that vary from state to state.

For information about this warranty write:



2701 Industrial Drive
P.O. Box 90004
Bowling Green, KY 42102-9004
www.desatech.com



113111 01
NOT A UPC

113111-01
Rev. B
06/04